

SF

524

. 52

W4

R32

ALBERT R. MANN  
LIBRARY

NEW YORK STATE COLLEGES  
OF  
AGRICULTURE AND HOME ECONOMICS  
AT  
CORNELL UNIVERSITY



EVERETT FRANKLIN PHILLIPS  
BEEKEEPING LIBRARY

# West Virginia Department of Agriculture

## BULLETIN

Published by the West Virginia Department of Agriculture,  
Charleston, W. Va.

OCTOBER, 1917

NUMBER 33

# Beekeeping for West Virginia

CHARLES A. REESE

Assistant Entomologist and Apiarist



(By A. I. Root Co.)

**J. H. STEWART,**  
Commissioner.

Entered September 17, 1915, at the postoffice, Charleston, W. Va., as second class matter under the act of Congress, June 6, 1900.

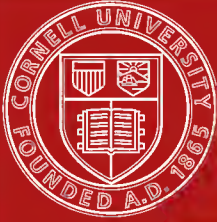

Cornell University  
Library

The original of this book is in  
the Cornell University Library.

There are no known copyright restrictions in  
the United States on the use of the text.

<http://www.archive.org/details/cu31924003429366>

# West Virginia Department of Agriculture

## BULLETIN

Published by the West Virginia Department of Agriculture,  
Charleston, W. Va.

---

OCTOBER, 1917

NUMBER 33

---

# Beekeeping for West Virginia

CHARLES A. REESE

Assistant Entomologist and Apiarist



(By A. I. Root Co.)

**J. H. STEWART,**  
Commissioner.

---

Entered September 17, 1915, at the postoffice, Charleston, W. Va., as second class matter under the act of Congress, June 6, 1900.

H

Office of  
**COMMISSIONER OF AGRICULTURE**

**Official Roster**

J. H. Stewart	Commissioner of Agriculture	Charleston.
C. H. Henning	Chief Bureau of Markets	Charleston.
B. H. Hite	Chief Chemist	Morgantown.
Cecil W. Wood	Chief Seed Laboratories	Charleston.
W. E. Rumsey	State Entomologist	Morgantown.
Chas. A. Reese	Asst. Entomologist and Apiarist	Charleston.
A. J. Holt	Consulting Veterinarian	Charleston.
C. C. Hudkins	Consulting Veterinarian	Charleston.
J. V. Stewart	Fiscal Agent	Charleston.
W. H. Sommers	Special Agent in Marketing	Berkeley Springs.
Arthur Gold	Special Agent in Horticulture	Mason.
Bert E. Sayre	Special Agent in Horticulture	Charleston.
Frank G. Miller	Special Agent in Horticulture	Elm Grove.
C. A. Dunn	Special Agent in Horticulture	Red Sulphur Spgs.
H. M. Rowe	Special Agent in Horticulture	Charleston.
R. F. Nesbitt	Asst. Seed Analyst	Charleston.
J. E. Bird	Special Agent	Charleston.
O. A. Petty	Special Agent	Charleston.
Frank B. Kunst	Assistant Chemist	Morgantown.
J. B. Krak	Assistant Chemist	Morgantown.
C. G. Dawson	Inspector of Fertilizer	Charleston.
Paul D. Reese	Special Agent of Gardens	Charleston.
Joseph Ankrum	Special Agent of Gardens	Charleston.
A. I. Wick	Mailing Clerk	Charleston.
R. W. White	Clerk	Charleston.
Meta Grove	Stenographer	Charleston.
Olive Wallace	Stenographer	Charleston.
Pearl Allender	Stenographer	Morgantown.
Helen Brady	Stenographer	Berkeley Springs.
N. E. Merhie	Official Photographer	Charleston.
Chas. E. Wheeler	Orchard Inspector	Matoka.
S. P. Mathews	Orchard Inspector	Stononsville.
L. H. Woolford	Orchard Inspector	Ford Hill.
S. A. Park	Orchard Inspector	Keyser.
Maurice Scanlon	Orchard Inspector	Three Churches.
Marvin W. Moore	Orchard Inspector	Montrose.
D. E. Swisher	Orchard Inspector	South Branch.
James Dunn	Orchard Inspector	Berkeley Springs.
L. V. Thompson	Orchard Inspector	Springfield.
T. K. Massie	Inspector of Bees	Hatcher.
P. L. Jones	Inspector of Bees	Parkersburg.
L. D. Sharp	Inspector of Bees	Slaty Fork.
M. K. Malcolm	Inspector of Bees	Institute.
Stephen Davis	Inspector of Bees	Morgantown.
Grant Luzader	Inspector of Bees	Pennsboro.
Adam J. Yahn	Inspector of Bees	Triadelphia.
R. P. Simms	Special Agent	Bluefield.
A. M. Curtis	Special Agent	Institute.
C. Ruth Campbell	Special Agent	Union.
Lillian Bagnall Gray	Special Agent	Glatto.
Geo. E. Fountain	Special Agent	Parkersburg.
Isaac Noel	Special Agent	Keystone.

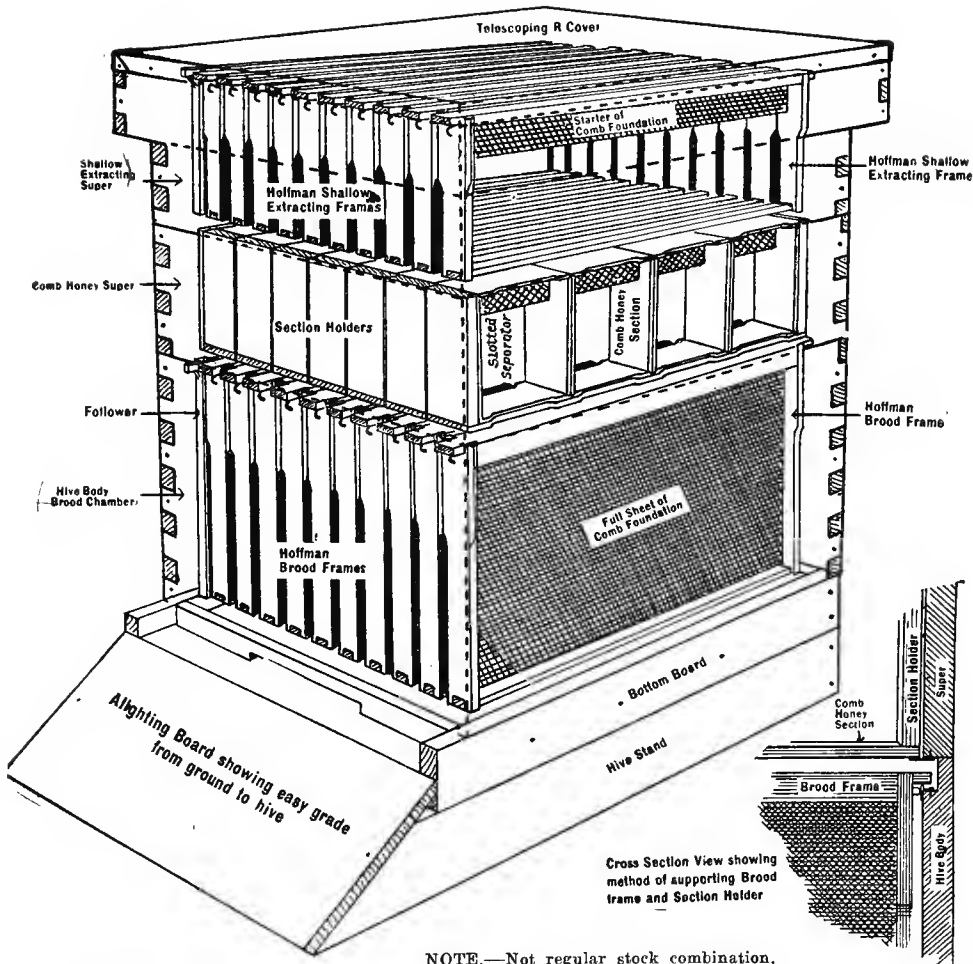

NOTE.—Not regular stock combination.

By A. I. Root Co.

Figure 1.

Modern Ten Frame Hive Showing Brood Chamber, Section and Shallow Frame Supers.





## INTRODUCTION.

Beekeeping today is gradually becoming more and more restricted to expert or commercial apiarists than to the farmer. The time when nearly every farmer in the state had a few stands of bees on his farm seems to have disappeared. The present condition may probably be due to neglect or possibly a lack of knowledge on general beekeeping. Many times other duties peculiar to the season may have demanded the farmers attention when the bees required some care, and they were left to shift for themselves. Perhaps the present tendency towards specialization has largely been one of the chief factors in neglecting the bee. Many farmers owing to their location have given up general farming and are utilizing their efforts along one special phase of Agriculture. In some localities production of fruit has taken the place of grain farming and production of live stock. Their pastures, meadows and lands that have been under cultivation have been set out in fruit trees. The value of the bee has been overlooked, not only the products of its labors, but its supreme importance as an agent in pollenization of the fruit bloom. It is no longer a supposition, but an established fact thru long years of experimentation and observation that bees are an absolute necessity in fertilizing the bloom of fruit. No commercial orchardist can afford to depend upon other agencies for the pollenization of the fruit bloom. Many commercial orchardists in the surrounding states have realized that a great percentage of their failure were due to lack of fertilization, not frosts. In order to safeguard themselves in the future, they either have started an apiary in their orchards, or hire some apiarist to move his bees to their orchards during the period of bloom.

In the past bees were housed under conditions adverse to the production of honey; even at the present time, in some localities, bees are kept in hollow logs, barrels and home made boxes of every dimension. To rob them in the fall of the year, only to get a mixture of honey and dead bees, is neither a pleasant or a profitable business. Bees kept under such conditions become weakened either through the loss of the queen, lack of stores, or disease, and many other factors influencing the normal strength of the colony, because of the impossibility of examination. The ever watchful "weevil" or bee moth makes its appearance and soon is the master of the colony. It is a sure indication that beekeepers troubled with beemoth are not familiar with the fundamentals of beekeeping, for the beemoth cannot overcome a colony that is strong and healthy. The resulting trouble from beemoth is really secondary and is a strong indication that another factor contrary to the welfare of the bee is present, causing the colony to dwindle and weaken. That the prospective beekeeper may not be misled by the glowing magazine articles and flowery statements, (to the inexperienced a "get rich quick scheme"); that bee-

keeping may be built up and commercial apiaries profitably conducted in West Virginia is the purpose of this bulletin.

It is a well established fact that beekeeping in West Virginia can be profitably conducted when managed carefully by putting into practice what has been brought to light by experts in the management and use of modern appliances. No greater opportunities are offered in the Eastern Central States than in West Virginia. Nature has blessed West Virginia with a flora consisting of a great variety of nectar-producing plants offering nearly a perpetual honey flow from the first spring flowers till frost. Having such a favorable combination of conditions, beekeeping is encouraged in this state, and it may well form the vocation for the young as well as for the old, for those living in the city as well as those living in the country, for the hale and the hearty as well as those suffering from impaired health.

#### SKETCH OF THE EARLY HISTORY OF BEEKEEPING.

The keeping of bees dates back in history as one of the first occupations of man. Rude carvings of the bee upon the tombs of the ancient Egyptians; the presence of honey among the trinkets of the mummied inhabitants as well as honey being mentioned in the Bible as a sustainer of life, indicates that the honey bee was held in high esteem by the people of that time. Honey was regarded a necessity as a food requirement for many centuries and remained as such within two or three generations of the present time. Bees were included among other live stock introduced in New England in 1638 during the colonization period of that section of America. During the Pioneer period of this state beekeeping was an important factor in every settlement. Honey and maple sugar in limited quantities were the only sources of sweets, depending largely upon the abundance of maple trees in the section settled. With the removal of the forest for agricultural purposes, maple trees were not spared so in some sections it became necessary to depend entirely upon the bees to supply the required sugar which is a necessity in all food requirements of the human body. Owing to the crude conditions under which bees were kept, swarming was intense and many swarms escaped to the forest. As years passed the wild colonies multiplied and with the addition of more swarms every year from the colonists apiaries the bees penetrated further and further in the new pastures. The movement of bees into new territory was at a greater rate than that of man which is clearly pointed out by the pioneers of this state finding bees present in the forests. Early beekeeping was very simple, new swarms issuing during the swarming season were placed in hollow logs and were forgotten until fall when the bees in those "gums" having the greatest amount of honey were killed. The returns were of rather poor quality, usually being more or less of a mixture of honey, pollen or "bee-bread", dead bees, and brood. Nevertheless it was relished by all, for sugar which is now common, was unknown.

## THE VALUE OF BEES.

The supreme value of the bee had never been recognized until the disappearance of the farm apiaries during the past ten or fifteen years. Failure, resulting from fruit not setting and decrease in crop yields, is largely due to the absence of bees during the blooming periods of the plants. The annual loss to West Virginia reaches millions of dollars not only losses in fruit and curtailed crop production, but in the production of honey, because of the absence of bees. Nectar, secreted by the nectaries of the flowers is the foundation for honey and every pound of honey produced is added wealth which can only be obtained through the agency of the honey bee. Every flower casting its nectar back to the soil, from which it came, does not materially increase the soil productivity. From the great kingdom of insects, the honey bee is the one of most value to mankind. Its ruling passion is INDUSTRY and its instinct at times even surpasses human knowledge, which all in all places it in the front rank of insects. It might be stated that if the bee did no more in its brief life than furnish its example of industry, social instincts, and economy, a few colonies would be well worth a place on every farm. Every farmer cannot afford to be without five or more colonies of Italian bees. Considering the value of the bee with reference to fructification in connection with the amount of honey produced, there is no other livestock kept on the farm from which a greater percentage of profit can be secured on the amount of labor expended and capital invested.

## NATURAL HISTORY OF THE BEE.

Even if bees have been kept by man from an early stage in human civilization, they do not possess any outstanding characteristics of domestication, which is clearly shown by their activities in the wild state differing in no respect from those kept in an apiary. Bees are insects induced by man to live in their immediate vicinity by suitable environment to their needs. Their instincts as shown by their activities do not indicate any change whatsoever in their tastes and dislikes. The colony in a modern hive will attack any intruder with the same amount of fierceness as the one having its abode in a hollow tree. Man has learned through experience that bees can be handled with the proper use of smoke. The bounds of instinct are not over-stepped, but their immediate activities are diverted along other lines.

The structure and instincts of the bees compel them to live a colonial life. Each colony is a kingdom in itself where each and every individual works for the interest of the community. The collection of individuals varies according to the season; the largest number are usually found at the height of the season in the summer while the smallest number is at the close of the winter.

The normal colony at the season of greatest activity is composed of three kinds of individuals, the Queen (under normal conditions only one), thousands of workers, and many drones. In addition to the adults there are all stages of developing bees.

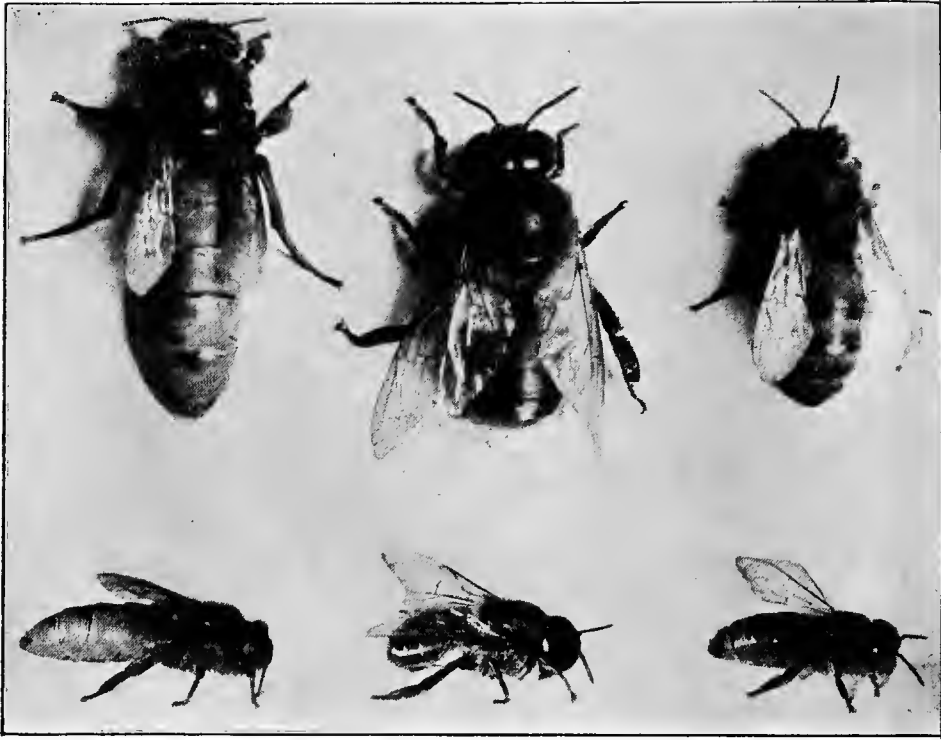

(By A. I. Root Co.)

Figure 2.

Queen, Drone and Worker.

### QUEEN.

It has been known for ages that there was an individual in the colony larger than the other, which was supposed to be the "King" or ruler. When it became known that this individual laid eggs the name was changed to Queen. Under normal conditions there is only one queen. She is the only perfect female and is the mother of the entire colony. Besides being larger than the other bees, she is somewhat different in shape, her body is longer, wings are shorter, and her abdomen is longer in proportion to that of the worker. She is armed with a curved sting which is used only in destroying other queens. Her sole duty is laying eggs which are deposited at the base of the cells of combs in that portion of the hives used for rearing brood. The number of eggs per day varies according to the season which governs the activities of the colony. During the winter months egg laying is reduced to a minimum. During season of production the queen reaches her maximum and is capable of depositing from 1000 to 5000 eggs per day,

depending upon the activities of the workers and conditions produced by the beekeeper. The queen only leaves the hive when accompanied by a swarn, and from five to fifteen days after emerging from the cell as an adult, depending upon the race and condition of the weather. This flight is known among beekeepers as her wedding flight, for at this time she comes in contact with a drone and is fertilized. Mating never occurs in the hive but always on the wing and always before egg laying and never afterward. In mating the queen receives a supply of spermatoza (male germ cells) which are stored in her spermatheca



(By Dadant)

Figure 3.

Eggs in Bottom of Cells (Greatly Enlarged). Note Two Eggs in Bottom Cell.

and remain functional during the remainder of her life, or until the supply is exhausted. If for some reason the queen is not mated during

the first three weeks of her life, the desire of mating is lost and she will lay eggs which produce drones. A drone laying queen can be determined by the irregular deposition of eggs and several present in each cell. A mated queen deposits her eggs regularly in a concentric arrangement. Eggs present in the super is a sign of limited space for breeding purposes. When a queen becomes barren, shows decrease in fertility, lost, injured through accident, or dies from old age, preparations are immediately made by the workers to rear another. The only other condition under which this activity takes place in the colony is in preparation for swarming.

### DEVELOPMENT OF THE QUEEN.

The egg from which a queen develops is no different from those which produce workers. The physical change that takes place is entirely due to change of environment during development. A fertile egg, or ordinary worker larva under three days old, is placed in a specially constructed cell resembling the cup of an acorn in shape, supplied with a profusion of milky food called by most authors "royal jelly." In reality, royal jelly is a concentrated, predigested food, rich in proteids, produced from a mixture of pollen and honey. At the end of six days the larva has completed its growth. During this time the cell increases in size accordingly. The cell is now nearly completed and is sealed. After which the bees put on a great excess of wax in drawing it to a long tapering point and the sides take on a corrugated appearance resembling an imperfect representation of honeycomb on a very small scale. Within the next seven days the larva passes through a complete transformation and becomes a fully developed insect. The condition of the temperature may slightly influence this development, so that it may be a day or two, or a few days longer before the queen emerges from her cell.

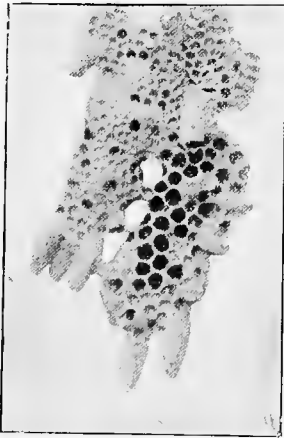

(By Dadant)

Figure 4  
Queen Cells.

### WORKERS.

The workers making up the mass of the hive are females whose sexual organs are undeveloped. The physical work of the hive is done by the workers. A lifetime of toil is their normal allotment. Gathering water, nectar and pollen to furnish food for the colony, secreting wax, building combs, feeding the growing larva, cleaning, guarding, ventilating the hive; in fact, doing all the work of the hive, except normally laying eggs, are the prescribed duties the workers are required to perform. Structurally the workers are fitted for their required duties; the eyes are well developed, the tongue is long in order to

reach the nectar secretions, the legs are variously modified, the third pair so constructed as to facilitate the carrying of pollen. The plates on the underside of the last four visible segments of the abdomen are modified on the edge pointing toward the head to form wax glands from which the wax used in comb building is secreted. The sting is straight and barbed, used only in self defense and protection of the colony. The length of the life of a worker bee is not measured in days and weeks, but by the amount of work they do. During the honey flow, they naturally work themselves to death and the population of the colony would decrease rapidly unless brood was being reared heavily. During such a period the average life of the bee is from three to six weeks, while in periods of less work the life is lengthened. Bees emerging during early autumn live over winter and begin activities the next spring. Bees dying during the active season die in the field, failing to return with the last load.

#### **DEVELOPMENT OF THE WORKER.**

The queen deposits an egg in the ordinary cell in which honey is stored; in three days it hatches into a very small pearly white larva grub. During the first day or two it is fed in limited quantities a milk white food exactly like that fed to the queen. The remaining four or five days of growth the food is of a coarser nature. Six days are spent in larval or growing period, and twelve days are required in the quiescent period during which it changes from a larva to a mature bee. Twenty-one days is the usual period of development from the time the egg is laid until the mature bee emerges from the cell. The newly emerged worker can be easily recognized by its small size and downy appearance.

#### **DIVISION OF WORKERS.**

The labor of the colony is divided between two classes of bees; young bees who perform the inside work of the hive, part of which is taking care of the developing brood, building comb and protecting the entrance against robbers; the old, or field bees, who are the foragers or gatherers whose duties are to gather nectar, pollen, and propolis or "bee glue." If there are few or no young bees, the older bees assume their duties.

#### **DRONES.**

Late in April or early in May when brood rearing is active, large, thick, clumsy individuals make their appearance and continue to increase in numbers during the productive season. These are the drones, and are non-producers, but living on the toil of the others. They are the males and their only function is that of mating with a virgin queen, the act of which is fatal to the drone. It is estimated that not more than one in a thousand ever perform that duty. Nature considers the queen's life extremely valuable, and in order to insure fertilization without undue exposures to hazards surrounding her

fight, hundreds and even thousands are reared in each colony in neglected apiaries during the breeding and swarming season. It is believed by many beekeepers that drones keep the brood warm in addition to their use as males. As a matter of fact, they keep themselves upon the brood to enjoy the natural warmth of the developing bees. But during a drop in temperature the workers driving the drones from the hive clearly demonstrates that they are useless in performing this supposed duty. They consume large quantities of stores, not only

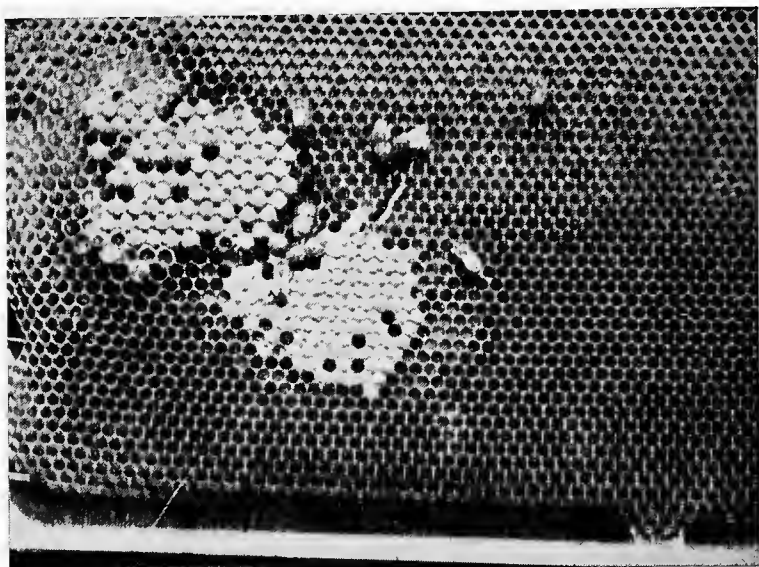

(By Dadant)

Figure 5.

#### Drone and Worker-brood Sealed.

in the development stages, but as adults as well. Drones have no sting, but fly with a large buzz, which often frightens the amateur who does not recognize their true character.

The life of the drone is uncertain, depending upon a great number of external factors. The honey flow coming to a sudden close they are driven from the colony. Likewise, a reverse in temperature means death to the drones. If a colony should become queenless, the drones are treated with more reverence. Possibly it is forseen by the bees, that, the virgin queen, without drones, would not be fertilized and the colony would perish. Unlike workers they are allowed to enter any colony without being challenged until the time of slaughter.

Drone traps have been placed upon the market to enable the beekeeper to destroy or reduce the number of boarders among his colonies. However, the use of drone traps is much similar to locking the granary after the wheat has been stolen, because a great quantity of food is required during the developing period that is consumed by drones, be-



sides the loss of labor from the nurse bees which could be utilized in rearing of worker brood. It is much better to prevent them in the first place, by the use of full sheets of foundation, which will be discussed later.

#### DEVELOPMENT OF THE DRONE.

The drones are reared in cells of the same shape as workers, but somewhat larger in size. The drone cells are about a quarter of an inch and the worker cells are about a fifth of an inch in diameter. It requires the same number of days for the hatching of the egg after laying, as in the worker or queen, while that of the larval and transformation period is much longer. Seven days are spent in the larval and fourteen days lapse until the mature drone emerges from its cradle. Capped drone brood is easily recognized by the dome-shaped cappings appearing like bullets while worker brood is comparatively flat.

#### RACES OF BEES.

The honey bee (*Apis mellifica*) is probably the widest known insect in the world. It is considered as representing the height of evolution among insects, in that the social organization is the most perfect of all insects living in communities. It is not a native of America, but was introduced by the early colonists. There are a number of distinct races, varying in size, color and disposition, depending largely upon their point of origin in the different parts of the old world.

Many varieties or races have been introduced into America and submitted to many tests in order to ascertain their merits. Roughly the races have been divided into three groups (1) Eastern (2) European and African races. Of the different races the hybrid bee, which is not a true race but a cross between the black bee and Italian, is the most numerous in West Virginia. Among the true races, Blacks are first in number with Italians second. There are few Caucasians, and in one instance Banats reported.

#### BEST BEES FOR WEST VIRGINIA.

To obtain the best results in honey production the beekeeper must possess the highest grade of bees obtainable. Among the different races there are large numbers of distinguishing peculiarities to be considered. Some races possess certain features that are desirable and likewise features that are entirely adverse to manipulation, such as, cross disposition, excessive swarming, excessive propolizers, and resistance to disease.

Italians are recommended above all other races, and in such case where the beekeeper has blacks or crosses, it is well to Italianize. (Discussed in later paragraph.) There are a number of reasons for keeping Italians, among those which possibly is the highest factor in bringing the Italian to its present place among beekeepers, is its resistance to European foul brood. It may be well to mention a few more characteristics in demonstrating their superiority in comparison to the

black bee. Italians are more prolific in the spring, easier to manipulate, guard their hives to better advantage against beemoth and robbers, work earlier and later in the day, as well as in the season, are more industrious and preserving, and have longer tongues and gather nectar from flowers where blacks are unable to reach the nectaries.

### WAX AND ITS PRODUCTION.

Wax, the material used in comb building, is a secretion produced in pocket-like organs or wax plates situated on the ventral or under side of the last four visible segments of the abdomen of the worker bee. Each segment bears two of the wax plates, making eight in all. Two conditions are necessary to produce this phenomena; bees seeking new quarters in swarming, and additional storage room during honey harvest. In order to produce wax the bees gorge themselves with honey and suspend themselves in festoons, hanging from the top of the hive or frame. After hanging motionless for about 24 hours, the honey has been digested and is secreted into a fatty secretion which in coming in contact with air hardens and forms scales of wax. The wax scales are removed from the pockets by the little spines on the pollen comb and passed to the front air of legs. It is then passed to the front pair of legs. It is then passed to the mandibles or jaws and masticated after which it is worked into comb.

### COMB AND ITS CONSTRUCTION.

The comb is composed of a series of horizontal or six-sided cells, built on both sides of a mid-rib or base, whose adjustment is such that the base of each cell composes three lozenges, each being one-third of the base of three opposite cells. It has been stated that comb is built with such accuracy that the maximum capacity and strength are obtained with the minimum expenditure of wax. The cells are not all the same size. Those in which worker bees are reared measure about five to the inch, or approximately 27 to the square inch and the ones in which drones are reared measure about four to the inch or nearly eighteen to the square inch. The total for both sides is double that number. Where worker and drone cells join, the bees overcome the lack of conformity by constructing cells of irregular shape known as intermediate or transition cells.

Besides the horizontal hexagonal cells already enumerated, there are found on the combs at certain times cells of a different type. They are circular rather than hexagonal, hang vertically, are larger than any of the other cells, and the outer surface is rough or corrugated, resembling a peanut to a large extent. These are called queen cells which are only used for rearing queens.

The worker and drone cells are not only used for brood rearing, but for storing honey and pollen.

### HONEY.

Honey is collected and not made by the bees. During the transfer from the flowers to the hive, "nectar" as it is called before gathered,

undergoes a slight change in the honey stomach by the action of the bees' saliva, and is called honey when stored in cells. The color, aroma and flavor varies according to the variety of plants from which it is obtained. Color ranges from water white to dark brown or black in some cases. Its consistency depends upon its water content which is controlled largely by the season of production, atmospheric conditions, soil moisture and variety of plants from which produced. It often contains as high as 90 percent water, especially that produced from white clover is sometimes so thin when first gathered that it drops from the comb when handled by the apiarist. Honey remains in this state a comparatively short time, then passes through a process that is popularly known as ripening; which however, is merely a reduction of the water content by evaporation. Evaporation, or driving off the excess moisture, is done by the normal warmth of the hive and a circulation of air through the hive brought about by a fanning process with the wings. During a heavy honey flow, rows of bees may be seen facing the hive along the entrance and often extending to the alighting board and even on the inside distributed over the combs, with their wings moving with such rapidity that they are invisible. This not only serves as an agency to assist evaporation but circulates pure air to the interior and regulates the temperature to the proper degree for brood development which remains rather uniform at approximately the same degree as that of human blood heat. The quantity produced from the different blossoms differs as well as the quality; likewise the flavor and color. As a rule those plants blooming early in the season produce the lightest colored honey, while those blooming during late summer and early autumn produce the darkest colors.

Bees do not always confine their nectar gathering to flowers, but sometimes they gather a sweet substance known as honey dew, which is mainly produced by aphids or plant lice, although in some instances it is an exudation from the leaves of certain plants. This sweet is very poor in quality and not accepted as honey. Since the beekeeper cannot prevent the bees from gathering it during some seasons, the sale of it must be tolerated, but for manufacturing purposes only. Where any appreciable amount is stored, it should be removed from the hive. Bees should never, if possible, be allowed to use it as food in wintering.

The quantity of nectar gathered in one day may vary from a few ounces to twenty pounds or even more, but an amount of this gain will be lost through evaporation in the process of ripening. It has been demonstrated by a large number of apiarists that twenty-five to thirty percent of the weight of fresh honey disappears during the first day. When honey becomes sufficiently ripened, the bees seal or cap the cells with a thin covering of wax.

#### **POLLEN OR "BEE BREAD!"**

Bees do not visit flowers for nectar only, but for pollen which serves as part of the food for bees both in the developing and active periods. It is gathered upon the tiny bristles on the legs and body hairs, and during the flight from flower to flower, it is worked into a pellet, on

the third pair of legs, to a peculiar structure, known as pollen basket. Bees returning to the hive during the working season are often conspicuous by the presence of the different colored pellets on their legs which varies in color according to the plant from which the pollen was obtained. Pollen is stored in the worker cells closely surrounding the brood.

During the winter when the bees are inactive, they do not feed on pollen. At that time honey is only consumed. However, during the early spring when the queen becomes active in egg laying, brood rearing is begun, and pollen is required for larval food. If there is a scarcity, flour or fine meal may be used as a substitute. It should be supplied to the bees in open vessels on warm sunshiny days. The flour should be well packed with the hands into a lump so the bees will not smother in it. To attract the bees to the flour, a little old honey comb is recommended. In localities where maple, willow or hazel are common early supplies of pollen will be maintained.

In gathering pollen, bees render a great aid to the horticulturist in the fertilization of fruits. Not only do they spread pollen upon the blossom they visit, but in their flights from blossom to blossom, they bring about cross fertilization which is essential in bringing most varieties of fruits to greater fructification.

#### PROPOLIS OR BEE GLUE.

Propolis is a resinous substance gathered by the bee from the buds and limbs of certain trees. In warm weather it is sticky and the bees apply it immediately to the purpose for which it was procured. It is used to stop the cracks in the hive, strengthen the junction of combs with the hive walls, reduce a too large entrance and to cover up obstacles that they are unable to remove from the hive, such as, dead mice, dead insects, chips of wood, etc. In the winter it becomes hard and brittle. It is brought to the hive in the pollen baskets, already mentioned. The amount of propolis gathered in a season depends directly upon the amount of nectar produced. If nectar is present in large quantities the quantity of propolis gathered will be small. If the season is dry and a small amount of nectar available, a large amount of propolis will be gathered and the entire inner walls of the hive will be coated.

#### WATER.

Bees use water in preparing the food given to the larva. In all seasons when brood is being reared and fresh nectar is not at hand, water is required. Water is usually carried to the hive during the earlier part of the day. Bees will search for available water supplies and unless some constant supply is near the apiary, they will travel some distance for it. It is best to see that the supply is near at hand, so the life of the bee is not endangered by long trips on cool spring days. A tub, or bucket with floating cork chips, or a long shallow trough receiving a constant supply from a barrel or hydrant should be maintained in the apiary. It is recommended where a trough is used to place a liberal quantity of salt at the end farthest from the source of water.

## BEGINNING AN APIARY.

Success in any occupation depends upon the amount of knowledge of the science upon which are founded the rules of that occupation. The objects of beekeeping is acquiring an accurate apprehension of all that pertains to the habits and instincts of bees, which make beekeeping a true science. In order to secure both pleasure and profit, the individual must possess a certain amount of knowledge of the laws that govern the home life of the never tiring bee. Much of this knowledge can be secured through literature as there are many good books pertaining to bees as well as various journals devoted entirely to beekeeping. However, information concerning their behavior is beneficial, but this is only a small part of beekeeping. The real value of this lies in the practice secured through the actual handling and manipulation of a few colonies of bees.

## WHO SHOULD KEEP BEES.

The requirements of a successful apiarist are patience, neatness, foresight and persistence before discouragements. In order to enjoy the work of an apiary, the individual must learn to handle bees without fear. Persons with a nervous or timid temperment should never attempt to keep bees, because if they have a constant fear of being stung during their manipulation, their terror is very quickly realized by the bees. The care of a small apiary is especially adapted to furnish a recreation for men of sedentary profession; viz: ministers, lawyers, doctors, professors, teachers, bankers, bookkeepers and clerks. Instances are known where professional men have received larger incomes from the apiaries than the amount of the yearly salaries. Very little capital is required to begin as it is advisable to start on a small scale.

## HANDLING BEES.

Handling bees with safety is not as difficult as the novice may imagine. They should be handled so that they will be disturbed as little as possible in their work. Stings should be avoided as much as possible during manipulations; not because of the pain to the operator, but because the odor of the poison diffused in the air irritates the bees in such manner as to make them more difficult to manage. It is recommended for this reason to wear a veil that is bee proof and have a smoker lighted so as to produce a cool smoke when needed. For the inexperienced operator, a pair of gloves can be worn, but ordinarily they are more of an inconvenience than otherwise. To prevent bees from crawling up the sleeves or trouser legs, tie the sleeves and legs tightly about the hands and feet. If possible, avoid black and woolen clothing, especially a black felt hat.

The hive should not be jarred or disturbed more than necessary. Rapid or quick movements are objectionable, as the bees can perceive motion more readily than they can stationary objects, because of their peculiar eye structure. On approaching a hive, never strike at a bee, as this only invites trouble, and is likely to be followed by a sting. The best time to

handle bees is during the middle of the day when the majority of the field bees are absent from the hive. Never attempt to handle bees on cold damp days or at night, unless absolutely necessary.

### HIVE MANIPULATION.

It is advised that a beginner in beekeeping visit an experienced apiarist to get suggestions and ideas in handling bees. More can be learned in a one day visit with a professional beekeeper than can be acquired in hours of reading literature on apiculture. Each beekeeper has his own methods and short cuts obtained by personal experimentation and study of bee activity which in reality are essentials in practical bee culture. For those who do not have the opportunities to obtain hints and suggestions on the proper manipulation of a colony of bees from a seasoned beekeeper, apply the following directions.

Whenever working in the apiary the smoker should be lighted and the veil put in place before opening any hives. When the beekeeper desires to examine the interior of the hive it is best to direct a few puffs of smoke into the entrance before removing the cover. This drives back the guards and causes the bees to fill up with honey which renders them tractable. Next, step to the rear or side of the hive and gently raise the cover and blow a little smoke vigorously over the top of the frames, or if a mat is used, remove the cover entirely and lift one corner, directing the smoke over the frames as it is being removed. Never use more smoke than necessary to keep the bees down on the frames. If at any time during manipulation the bees show signs of excitement give them a little more smoke. After exposing the frames, carefully pry them loose with the hive tool and crowd them to one side in order to permit sufficient room for the removal of the first frame. Gently remove the frame and lean it against the hive so there will be more room inside for handling the remaining. It is essential to be careful in all manipulations not to crowd or crush any bees as it greatly irritates the colony and may make it necessary to discontinue operations. Furthermore the queen may be killed or injured in careless handling. Bees crawling on the hands may either be thrown or gently brushed off.

### EXAMINING THE FRAME.

Always hold the frames over the hive as much as possible during examination so if any bees or the queen fall they would drop back into the hive. Likewise any honey dropping from the comb and falling into the hive is quickly removed while otherwise if dropped on the outside it is lost or may incite robbery. The frame on which the queen is found should never be taken out and placed against the hive as she may crawl away and be lost. Always lean the frame on the side farthest from the operator so as to prevent the bees from crawling up the legs.

In lifting the frame from the hive grasp each end with the hands and raise it straight up and out of the brood chamber or hive body and hold it in a vertical position with one side toward the operator.

To examine the reverse side, hold the one end stationary and raise the other to a perpendicular position and turn the frame on the top bar as an axis until reverse side is in view and then lower to a horizontal position with the top bar below. To bring the frame back to its original position reverse the operation. This method prevents all extra strain on the combs.

If self-spacing frames are used, the apiarist need not be as careful in replacing them as in replacing the plain ones in which case it is necessary to have them all spaced the same distance. Careful spacing is essential in preventing the bees from building combs of irregular thickness or brace combs from one frame to another.

### STINGS AND REMEDIES.

There are many remedies for bee stings recommended, but all are useless. The puncture is so small that it closes when the sting is removed and liquids cannot enter. Furthermore, the poison diffuses so rapidly that it enters the blood almost immediately. When stung, it is best to remove the sting as soon as possible without squeezing the poison sac. This can be done by using a knife or finger nail. Never rub or apply liniment to the wound, as it serves to increase the after-swelling.

### LOCATION OF APIARY.

Any location is suitable unless a large number of bees are expected to be kept. The keeping of a few hives often on a city lot, on top of a city building, or roofs of porches, has been successful in many instances. Where beekeeping is a specialty, it is best to choose a location where fruit and flowers are abundant. The timbered territory in this State offers exceptional opportunities for apiary sites. There are many localities in West Virginia near rivers or streams where linden, sumac, maple, willow, sour gum, and other trees, shrubs and vines that yield pollen and nectar abound in great quantities. The apiary should always be near a dwelling or where bees can be heard or seen during the swarming season. Where bees are expected to be kept on a large scale, the selection of the apiary site should receive careful consideration. Aside from the general consideration of honey producing flora for bee forage, shelter from prevailing winds, distance from stock or pedestrians, and slightly sloping exposure to facilitate natural drainage for surface water, are important. The consideration of protection from direct sunlight in relation to no protection has been the subject of much discussion, but without proving the advantages of one over the other. It has been demonstrated, however, that bees prosper best in the open with the hives having the protection of shade boards to prevent melting down of the combs, and bees clustering on the outside because of excessive heat. Bees located in the open, fly earlier and without doubt gather more nectar than those situated under trees. Shade that is too dense results in dampness which is to be avoided. An effort should be made to turn the entrances of the hives from the prevailing winds. Naturally, the apiary should face the rising sun or

the south and only in rare instances toward the north or northwest. The matter of wind breaks deserves attention. Hedges, forests, orchards, as well as buildings, and tight high board fences, make excellent wind breaks. The old custom of constructing sheds opening on one side in which to keep bees, is discouraged. Such buildings still in use should be abandoned. The proper manipulation of the hives are hindered to such an extent that they are a detriment to the beekeeper and the bees. Hives arranged in groups set on brick or drain tile overcome dampness, and are more easily attended than if they were placed on high shelves or benches. The entrance should be at least an inch lower than the back part of the hive so as to prevent the accumulation of water at the rear of the bottom board. A piece of board placed in a slanting position from the entrance to the ground assists the heavily laden bees to the hive as they often fall before reaching the entrance. Grass and weeds should not be allowed to obstruct the entrance. The use of sand, gravel or cinders around and under the hives, will prevent the growth of grass and weeds; or a liberal quantity of salt along the front of the hive will assist in control of this matter. Pasturing the apiary with three or four sheep will keep the grass and weeds from reaching an obstructing growth.

#### WHERE AND HOW TO OBTAIN BEES.

Where no bees are at hand and an individual having no experience in the handling of them desires to begin an apiary, it is advisable that he purchase two or three strong colonies from some reliable breeder or dealer. If the individual has bees and wishes to increase the number of colonies in his apiary the same can be done through the purchase of pound packages in the spring of the year from southern bee breeders. It has been found through experience by many apiarists that returns from colonies started from pound packages have more than repaid them for the bees and labor the first season. Where bees are already at hand and the size of apiary is desired to be increased, the same may be brought about by artificial methods as explained under swarming.

Spring is the best time to transport or move bees from one locality to another. April is probably the best month because the combs contain the least amount of honey, and the colony is at its minimum in numbers. Bees in hives can be moved with ease by simply nailing the cover and bottom-board to the main body and closing up the entrance with ordinary wire window screen. Sufficient ventilation will be supplied through the wire cloth. If the weather is hot, it will be necessary to remove the top and bottom board and replace them with a frame fitted with wire cloth protected with slats which lessens the danger of having holes punched through it. Bees transported under such conditions should be protected from the direct rays of the sun. Where bees are transported short distances, less than two or three miles, there is danger of the old bees returning to their old stand. To avoid this, drum them so as to frighten them before releasing, and then it is well to place some obstruction in front of the entrance which causes the bees to notice the change in location at the first issue.



Bees have the habit of marking their location. In so doing they leave the hive and fly but a few inches and then turn their heads toward the entrance and fly back and forth gradually increasing the distance, taking a survey of the immediate surroundings and noticeable objects in the vicinity of the hive after which they return to the hive and start in a straight line from it. On returning they come directly to the hive and enter. So thoroughly is the location of the hive learned that if the entrance is moved a foot they are likely to miss their landing on the return from their first trip.

#### KIND OF BEES TO BUY.

Some prefer to purchase ordinary bees regardless of the race in any ordinary type of hive and then transfer them to a movable frame hive in order to gain experience. In some cases this is justifiable but there are many things to be taken into consideration. Often times through the process of transferring, the queen may be injured or killed and resultingly the colony dies. Diseases may be present. Combs may be old and crooked, and direct transfer to a movable frame hive is impossible as well as impracticable. In purchasing bees in box hives it is well to examine the hive carefully by inclining it to one side or inverting it and looking between the combs. If there is an abundance of capped brood, young larvae and bees, it may be considered in

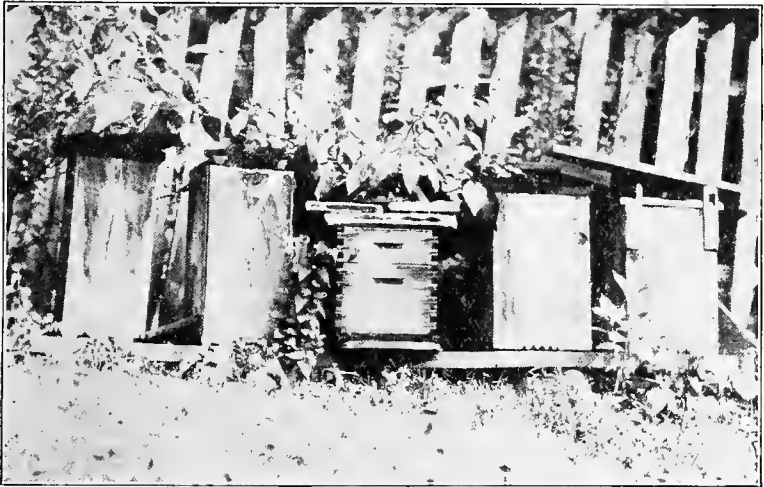

Figure 6.

A Good Start But Poor Housing. Bees Should be Kept in Only Modern Hives.

good condition. Colonies having numerous bees flying in and out on a warm day in the spring, and if it appears that many bees are returning with pollen on their legs, they may be considered safely good to buy.

Many times swarms of bees can be purchased from a neighbor beekeeper during the swarming season. Where this is possible the first swarm cast is desired. After the swarm is well established it is best to remove the queen and introduce another, thus lessening the risk of loss through an old queen which has lost her vigor and prolificacy.

### EQUIPMENT AND ITS VALUE.

It cannot be emphasized too strongly that bees can only be kept profitably in movable frame hives. Likewise the use of full sheets of foundation in the frames causes the bees to build straight combs, making it very easy to manipulate or interchange them whenever the beekeeper desires. The keeping of bees in boxes, hollow logs or barrels, is not profitable and in many cases a menace to the progressive beekeeper, especially where brood diseases are prevalent.

### WORKSHOP.

It is usually desirable, especially where an apiary is of any size to have a workshop, or honey house as commonly called by beekeepers, where the supplies may be prepared and stored, as well as caring for the honey crop. Where the apiary site is not level it is recommended that the building be placed at the lowest part of the site so as to facilitate the carrying of heavy loads down grade. The building need not necessarily be very expensive, the only necessary features about the construction is to have it bee and mouse proof. The latter can be easily done with the use of a concrete floor. To prevent the entrance of bees the windows and doors should be well screened with wire cloth. This should be placed on the outside of the windows extending about six inches above the opening. To provide exit for bees which accidentally get in the house, the upper boards should be held away from the frame with narrow wooden strips about a quarter of an inch thick. Bees will not enter at the openings. However, any that are likely to be carried in the house will fly at once to the windows and crawl upward, soon clearing the house of all bees. The arrangement of windows should be such that the sash may be slid entirely away from the openings to prevent bees from being imprisoned. The arrangement of benches and racks for tools, supplies and surplus comb can be made to suit the tastes of the owner.

### HIVES.

The type of hive recommended for use in this state is a movable frame hive—the principal of which was invented by Rev. L. L. Langstroth. The hive body proper consists of plain wooden box holding frames hanging from a rabbet at the top and not touching the sides, top or bottom. Hives of this type are constructed so as to hold eight, ten or more frames. The ten framed hive with standard equipment is recommended for use in West Virginia. The frame considered as standard and in general use is the metal spaced Hoffman

frame ( $9\frac{1}{8}$  x  $17\frac{5}{8}$ ). One of the outstanding features of this type of hive is the size of spaces between the frames, side walls and supers which are of sufficient size to allow easy passage of bees. In a space of this size bees will rarely build comb or deposit propolis. In selecting hives, it is important that the materials be of the best, all parts accurately made so that all hives and hive parts are interchangeable. All hives and hive parts should be of the same style and size and as simple as it is possible to make them, so as to facilitate operations. As a rule it is best to buy hives and frames from a manufacturer of bee supplies rather than make them, unless one is an expert woodworker. Even then, it is best to buy the frames as they can be purchased at a lower rate than the amount of labor and materials would cost in home manufacture.

Hives should always be painted to protect them from the weather. Experience has proven that in order to prevent excessive heat absorption by the colony in hot weather, the light colors are the most satisfactory. Avoid red or black in all instances.

#### DETAILS OF A 10 FRAME LANGSTROTH HIVE.

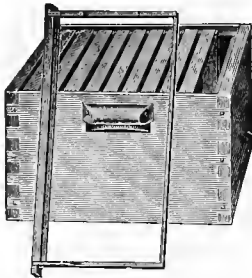

(By A. I. Root Co.)

Figure 7

Hive-Body With Plain  
Hoffman Frames.

The modern movable frame hive is made up of the following parts. Bottom board, brood chamber or hive body, containing ten frames; super or storage room either of same dimensions as the brood chamber for extracting, or have the height for comb honey sections of shallow extracting frames.

In the construction of the hive body it may either be dovetailed or rabbeted at the corners. Where hives are made at home it is recommended that the woodworker build one of rabbeted corner type, unless machinery for dovetailing is available. The rabbeted corner hive has the advantage over the dovetailed in as much as it does not have as many joints exposed to the weather. Both hives should be nailed on each side to prevent warping.

#### FRAME.

Some apiarists prefer a plain hanging frame. These are only satisfactory where the beekeeper has become skilled in spacing. For all general purposes the Hoffman self-spacing frame is the better, especially for the beginner; for they are so spaced that only ten and no more will conveniently fit the hive body. Self-spacing frames prevent irregular, narrow, imperfect combs, and with the use of foundation the combs are always built straight. A large part of the success obtained by the apiarist is largely due to standard equipment, i. e. having all hive bodies, bottom boards, frames of one size and one

style, so that all parts are interchangeable at all times and occasions without delay or hesitation.

In addition to the hive in which the bees are kept, it is necessary to have other equipment to facilitate their handling. Since it has become known, through experience, that bees are less inclined to sting when filled with honey, it is found through the use of smoke the bees become frightened and filled up with honey. Smoke is harmless when properly used. A good smoker, consisting of a tin or copper

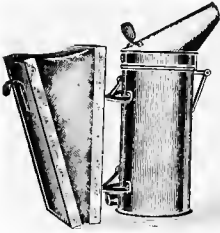

(By A. I. Root Co.)  
Figure 8

Standard Root  
Smoker

receptacle to hold material producing an abundance of cool smoke with a bellows attached, is indispensable. Rotten wood, oily waste secured at garages or machine shops, gunny sacks and cloth, are some excellent smoker fuels.

Likewise a good veil is necessary to prevent stings on the face and neck. A veil of black material, preferably with a black silk tulle front. Such may be placed over a hat, the bottom of it coming down under the coat or vest, or by the use of a draw string, may be adjusted over the shoulders and fastened in front to a button. This will make a complete protection. Wire cloth veils are also excellent. Black fronts are recommended. Even if a veil is not always used, it is desirable to have one at hand in case the bees become cross.

For those who are beginning beekeeping and until fear is overcome through familiarity, a pair of leather or cloth gauntlet gloves serve as protection to the hands. Gloves become cumbersome and hinder most manipulations. The seasoned beekeeper prefers to have his hands free at all times, paying little attention to stings.

#### SPECIAL EQUIPMENT NEEDED.

It is important to have some sort of hive tool, which may be an ordinary screw driver, a putty knife, or better a special tool.

Drone traps, feeders, bee escapes, foundation fasteners, bee brushes, and special apparatus for producing comb and extracted honey, will be mentioned where their needs are required.

#### COMB FOUNDATION AND ITS VALUE.

It has been estimated that it requires from seven to twenty pounds of honey to be consumed by the bees to produce a pound of comb. The amount undoubtedly varies according to the season, the warmth of the hive and strength of the colony. Since the amount is so variable, it can be safe to estimate that it costs the bees no less than an average of ten pounds of honey for each pound of comb produced, including the time lost in secretion and construction. The cost of comb can be easily estimated. Since the averaging price of honey this past season has been twenty cents, the cost for one pound of comb would be two dollars. Furthermore it has been determined to a degree of certainty that one ounce of comb will hold one pound of

honey. Then for every sixteen pounds of honey it requires an additional ten pounds of honey to produce the comb.

The above figures certainly shows economy, saving and an insight to the value of comb foundation in a monetary way. Comb foundation consists of sheets of pure beeswax with the imprints of the base of the embossed cells upon it. The evolution and process of its manufacture is too tedious, complicated and lengthy for explanation in this bulletin. (The reader is referred to some manufacturers catalogs or text book on apiculture.) There are a number of different grades manufactured for different purposes. For use in brood combs, sheets measuring about 6 square feet to the pound is best as the bees find nearly enough wax present to build the entire comb. For surplus honey in sections or shallow frames for chunk honey production, the use of thin sheets of comb foundation of the very best grade of light colored beeswax should always be used in order to prevent the "fish bone" toughness of a heavy artificial midrib.

#### ADVANTAGES OF COMB FOUNDATION.

There are three primary advantages derived in the use of full sheet of comb foundation. It has already been mentioned that it requires approximately ten pounds of honey to produce a pound of wax. In comparing the present price of honey with the present price of comb foundation there is a saving of more than twice the amount of the cost of foundation.

Secondly, the bees are given guides upon which to work. All combs will be straight which really makes the handling of bees a pleasure. Where combs are crooked, it is disagreeable to manipulate the frames and often times impossible to make an interior examination. Leakage of honey in handling is prevented which reduces robbing as well as being mussy and unpleasant to the operator.

The third advantage probably more important than all combined is the elimination of excessive drone comb. It has been already stated that the drones consume large quantities of honey both in the developing and adult stages and are non-producers. This necessarily means a two-fold saving both in the amount of honey consumed and labor in caring for the developing drones which will be utilized in the production of workers, and in turn increases production. The apiarist need not be alarmed in not having a sufficient number of drones to fertilize the virgin queens in his apiary as there are always plenty of drones reared in the corners or in cells that that have become accidentally enlarged. Only one drone is required in fertilization.

The wax used in manufacturing foundation must be absolutely pure beeswax. Many attempts in adulteration have been tried but none as yet has proven successful. Bees seem to recognize their product from all other compounds and will refuse to accept foundation where any adulteration with other mineral or vegetable waxes are used. They destroy and remove such foundation from their hive.

Full sheets of foundation should be fastened securely to the frames. Frames are now manufactured with a groove exactly in the center of the cross frame for attaching the foundation which is held in place by a wedge, or cleat securely tacked. It is also essential that the foundation

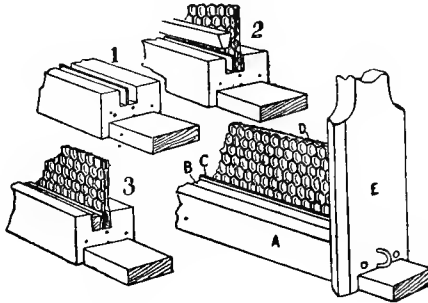

(By A. I. Root Co.)

Figure 9.

Corner-cut Top-bar Method of Fastening Foundation.

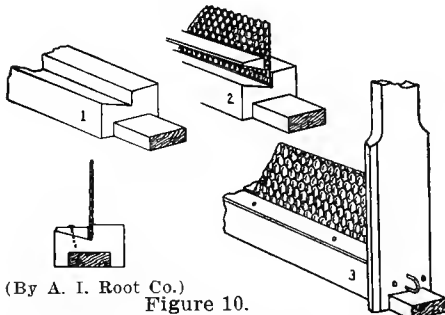

(By A. I. Root Co.)

Figure 10.

Wedge-top-bar Method of Fastening Foundation.

be fastened with wires which hold it straight as well as adding strength to the comb. The wires are imbedded in the foundation either by an instrument called "wire imbedder" or by an electrical imbedder which heats the wire and melts its way into the wax. This probably is the better of the two methods. The electric imbedder is cheap and the current is supplied by two ordinary dry cells. It can be supplied by any bee supply company. For sections, there are a number of fasteners placed on the market that insert the foundation by heat. Where comb honey is produced in large quantities an instrument of this nature is indispensable.

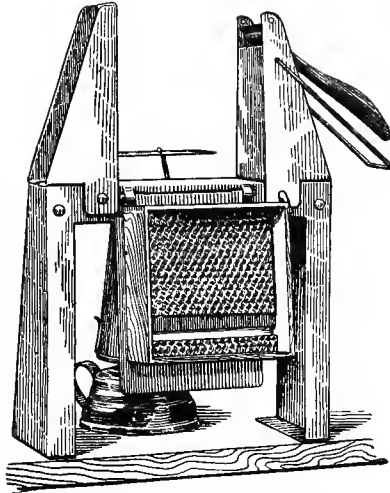

(By Dadant)  
Woodman's Section Fixer.  
Figure 11.

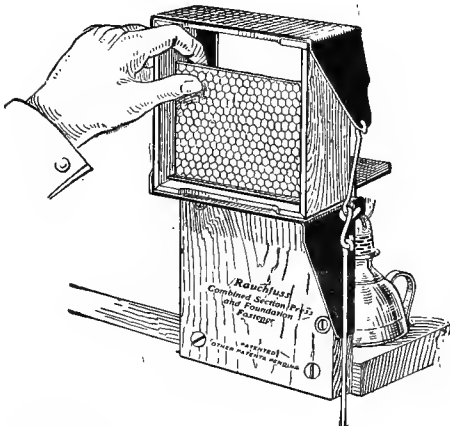

(By Dadant)  
Figure 12.  
Rauchfuss Combined Section Press and  
Foundation Fastener.

### SWARMING.

Nature has provided some method of perpetuating the race among all living things, so swarming is the natural way of increase for bees. It usually takes place during a honey flow when stores are abundant. Colonies about to swarm sometimes show a clustering at the entrance of the

hive for some days before the swarm issues. There are exceptions, however, and the bees come out where there is little or no indications of a swarm.

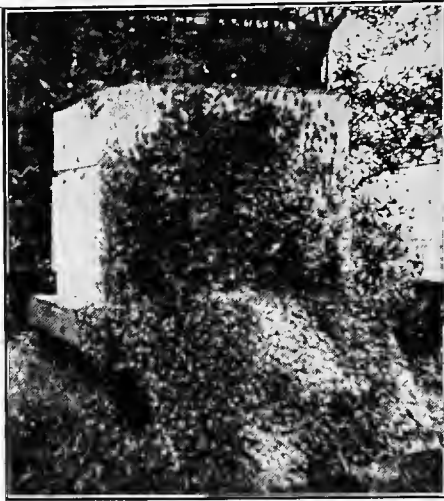

(By A. I. Root Co.)

Figure 13.  
Swarm Entering Hive.

If for some reason or cause the queen should fail to join the swarm, the swarm will return to the hive as soon as they make the discovery. Sometimes the swarm will fly directly to their newly selected quarters without clustering but this seldom happens.

#### AFTERSWARMS.

Secondary or afterswarms issuing a week or so after the first swarm are not desirable and should be returned to the original hive after all queen cells have been removed. This usually does away with any further swarming for the season.

#### CARING FOR THE SWARM.

It is always best to have hives prepared in advance for emergencies. The frames should have either full sheets of foundation or drawn out comb. After placing the hive in readiness, remove the entrance block so that the bees will have a wide opening to enter the new home. Then spread a sheet or cloth of some material other than wool in front of the hive. If the bees have clustered on a tree, remove the limb or branch very carefully and carry it to the hive and shake the bees on the sheet. By gently tapping on the front of the hive the attention of the bees will be directed that way and with the addition of a little smoke directed upon those inclined to crawl away from the hive will start them in the

An interior examination of the colony is the only method to ascertain with any degree of certainty if they are about to swarm. If queen cells are found with eggs or larvae nearly sealed a swarm may be expected soon after the cells are sealed or as soon as the weather is favorable.

After the bees issue from the hive they whirl a few minutes in the air and then cluster into a mass on a branch or limb of some convenient tree or bush. They should be hived as soon as possible after the cluster is formed for they may soon leave to seek their new home that has been selected by scouts sent out for that purpose.



right direction. It is essential to be certain that the queen enters the hive. The combs can be examined or a careful watch made to see if she enters. After the queen has entered the hive it is quite safe to conclude that the bees will remain. If she has been lost the bees will either return to the point of clustering or to the hive from which it issued. If a frame of brood from another colony is placed in the new hive it will prevent the swarm from leaving or if the queen has been lost it will give them the means of rearing another.

If the bees cluster where it is impossible to remove the limb of a tree with the bees or upon a branch too valuable to cut, they can easily be driven into a basket or box by blowing a little smoke upon them in the direction they are desired to be driven.

### SWARM CONTROL.

Unless increase is not desired, natural swarming should be discouraged so far as possible, so that the energy of the bees shall be utilized in the gathering of nectar. The old practice of measuring success in terms of new swarms in reality shows losses in the crop. Success is now measured in the result that the beekeeper attains in swarm prevention. The commercial apiarist has learned that swarming is the one great handicap in beekeeping.

The problem of entire swarm control is a goal which cannot be attained, for swarms will issue in spite of every precaution, but in many instances it may be reduced to a large measure. The practice of the Dadants in their apiary management probably come as near to any means of control. The let-alone or Dadant method is explained in the following six statements.

1. Locate the colony in a place where the bees will suffer as little as possible from the heat. The use of shade boards is recommended in this connection.

2. The elimination or reduction of drone rearing to a minimum. In this case the use of full sheets of foundation, destruction of drone combs and replacing it with worker comb, produces more workers, fewer drones, and less incentive for swarming.

3. Providing ample super room for storage. Bees that are crowded for room prepare at once for swarming.

4. The provision of sufficient room for ventilation. A proper amount of ventilation is essential and can be easily adjusted by raising the hive from the bottom board, and blocking it up about half an inch or inch if the weather is hot and sultry.

5. Requeening each year with a young Italian queen. The old queen is often the cause of swarming because the bees noticing her decrease in fertility make preparation to replace her by starting queen cells and thereby stimulating swarming.

6. In connection with the above recommendations, it is advised to space the frames an additional eighth of an inch than provided in the modern hive to give the bees more room for clustering and better ventilation between the combs. This can be very easily done by removing a frame during the hot days of the season and utilize the space by equal

spacing of the remaining nine. There are many other means taken by apiarists to eliminate swarming, such as destroying queen cells every week, using queen traps or entrance guards to prevent the queen from leaving the hive, spreading the brood, raising the brood to the upper story, and many other laborious manipulations or extra contrivances which require much extra time.

### ARTIFICIAL INCREASE.

Where the apiarist desires to increase the number of colonies in the apiary it is best to practice some method of artificial increase rather than wait on the pleasure of the bees to swarm. There are a number of different methods of increasing the apiary, such as dividing the brood, and bees, of an individual colony into two equal portions and providing a queen for the queenless half or dividing the parent colony into small colonies or nuclei. These plans are not as satisfactory as "shook" swarming, for colonies so made lack vigor and the entire season is required to build them up to strong colonies.

"Shook" swarming consists merely of shaking the bulk of the bees from the combs of a strong colony into another hive on the old stand. The new hive should be supplied either with full sheets of foundation or drawn combs or a combination of both with the addition of one frame of unsealed brood to prevent the bees from leaving. The hive containing the remaining brood with some bees should then be removed to a new location. If supers have been previously installed they should be placed over the artificial swarm with a queen excluder between it and the brood chamber. This method should not be practiced too early in the season as natural swarming may take place later. Dividing should be done in the middle of the day when the bees are in the field and the yield of nectar is abundant.

Some beekeepers prefer using narrow strips of foundation for the artificial swarm. This provides no cells for the queen to lay eggs for a time, thus reducing brood rearing. However, by the time brood is reared the profit derived from the young bees is usually past. This is a gain rather than a loss, because the bees will largely divert their time gathered nectar and place it in the super as there are no cells in the brood compartment in which to deposit the honey. The combs will be gradually drawn out and brood rearing increased in accordance. Sufficient amount of honey will be placed in the brood chamber for the winter supply. The chief disadvantage in using narrow strips of starter is the excessive drone comb which is likely to be built.

It is essential to note if queen cells are present in the hive with the remaining brood. If none are present, eggs or young larvae under three days old should be provided in order to rear a queen for this colony. A better plan, however, would be to provide a queen so as to hasten brood rearing.

### QUEENLESS COLONIES AND LAYING WORKERS.

Many times a colony loses its queen either by old age, accident through careless manipulation and many other causes too numerous to mention. Bees in a colony that is queenless usually manifest the

same by being restless, easily provoked, walking around the entrance listless and without eagerness, and few leaving in search of nectar or pollen.

No time should be lost in providing the queenless colony with a comb of eggs and young larvae from which to rear a queen. If an extra queen is at hand it is better to introduce her at once for practically three weeks work will be gained.

After a colony has been queenless for sometime a worker which is an undeveloped female may be sufficiently sexually developed to lay eggs. The laying worker deposits eggs in a very irregular manner sometimes two or more eggs to a cell. All bees developing from these eggs are drones as the worker is incapable of meeting a drone and becoming fertilized. If laying workers or a drone laying queen are present, the most effective way to dispose of them is to break up the colony and distribute it among strong colonies having fertile queens.

#### UNITING.

When a colony becomes queenless in late fall or early spring it is more profitable to unite it with another weak colony with a queen or with a normal colony to save the bees. In uniting colonies each should be smoked vigorously. Another method is to place the weak colony on top of the normal colony with a sheet of newspaper between them. The bees gradually work holes through this and unite without any trouble.

#### TRANSFERRING.

There are many bees in this state hived in box hives or log gums. Keeping bees under such conditions is unprofitable and should be discouraged. The colonies should be transferred as soon as possible into movable frame hives. The best time for this is during the season of fruit bloom. At this season the hives are not over run with bees and are light of honey. Select a day when the bees are at work on the bloom as this lessens the danger of robbing. There are a number of plans that the operator may choose.

One method is to remove the box hive a short distance from its stand and in its stead place a hive with movable frames containing full sheets of foundation. Turn the box hive upsidedown and place a small empty box inverted over it. By pounding or drumming on the box for several minutes the bees will become frightened and desert their combs and cluster in the empty box. The bees may then be dumped in front of the entrance of the new hive placed on the old stand. It is essential to watch in order to see the queen enter the hive. In case she has not left the old combs repeat the operation until she is found and seen to enter the hive. It is necessary that the queen be in the hive to be successful in the operation. The box hive containing the brood should be placed right side up and in a new location. In 21 days the worker brood will have emerged and very probably a new queen will have been reared. Repeat the operation in drumming and unite the young bees with their former hive mates, first

smoking the colony vigorously and allowing the drummed bees to enter the hive through a queen trap so as to keep out the young queen. Destroy the box hive, render the wax and use what honey it may contain on the dinner table. This method insures straight combs. If the colony becomes short of stores provide them with food.

Sometimes the beekeeper desires to save the combs in the box hives.

In this case drum the bees into a box as above mentioned and remove the brood combs and other combs free from drone cells, cut them to fit the frames and tie them in place with cord string. The bees will repair the breaks, fasten the combs to the frames and remove the string. The frames should be placed in a hive on the old stand in order not to lose the returning bees. This procedure more or less is disagreeable and the combs thus obtained are of little value.



(By Dadant)

Figure 14.

Cutting Combs to Fit the Frames.

### REMOVING BEES FROM HOUSES AND TREES.

Often times bees take their abode in trees and walls of a building where it is desirable to remove them. This is best done by placing a "Porter Bee-Escape" at the entrance which allows the bees to come out but prevents their return. A hive should be placed on a platform along the side of the entrance. The bees on returning find their way blocked, and enter the hive. It is a good plan to place a frame or two of capped brood and young bees in the hive which invite the trapped bees to adopt the new shelter sooner than if only foundation and drawn combs were present. Since the queen never leaves the colony she is not trapped and continues to lay eggs, but since the colony is rapidly being reduced in size the amount of brood decreases. As the brood emerges the young bees leave the cavity and join the colony in the hive and finally the queen is left practically alone. A queen should be introduced in the hive as soon as there are enough bees to support her. After about five or six weeks the escape can be removed and the remaining bees and queen suffocated by the use of sulphur fumes. Replace the escape for several days. Then remove entirely and enlarge the hole. The bees will go in and remove all the honey leaving only the empty combs. After the bees have

carried out all the honey, close the hole securely so as to prevent another swarm from taking up quarters there.

### ROBBING AND ITS PREVENTION.

Frequently when there is a dearth of nectar, bees are inclined to rob other colonies, especially those in a weakened condition. Feeding and returning the extracting supers often attract other bees. It is a good plan to return the supers and feed in the evening to prevent excitement. When the bees show the slightest inclination of robbing, discontinue manipulations, close the hives, and if necessary contract the entrance as much as weather conditions will permit. The placing of weeds and grass in front of the entrance is an aid to prevent robbers from attempting to enter. Always keep honey that is removed from the hives where the bees cannot get to it so as not to incite robbings.

### HOW TO ITALIANIZE AN APIARY.

The merits and superior qualities of the Italian bees has been discussed in a preceding paragraph. Since this race of bees has been highly recommended by all authorities on bee culture the apiarist often desires information concerning the Italianizing of his apiary. To do this a tested Italian queen should be purchased from some reliable queen breeder and introduced into one of the colonies of the apiary. Since the queen is the mother of the colony, the changing of queens is merely a step in changing the entire race of the colony in a few weeks.

To introduce a queen successfully, it is essential to find the queen to be superseded and destroy her. Either remove the new queen from the cage in which she is received and liberate the accompanying workers and replace her in a new cage, or release the workers and allow her to remain in the cage and suspend it between the combs. The mailing cage usually contains a candy stopper which should be exposed to the bees by removing the protecting shield. In the course of several days the bees will liberate her by eating the candy plug. The accompanying workers are very rarely accepted by the bees in the colony and may cause the queen to be rejected. There are a number of other methods of introduction practiced by experienced beekeepers but they are not as safe as the cage method.

After the Italian queen begins active egg laying frames containing her eggs can be given other colonies in which the queen has been renewed. It is best to wait several days after removing the queen in order to destroy all the queen cells before introducing the frame containing the eggs, so as to be positively sure that the queen reared is from the select queen and not from eggs laid by the inferior queen destroyed. The bees usually start a number of queen cells. It is therefore desirable to place some protection around all but one cell so as to save every queen that emerges. The remaining queens can be introduced into additional queenless colonies and therefore requeen a number by the queens reared in the one colony. This saves time and

expense. The cells may be protected by removing them from the comb or placing a cage around the cell made of wire cloth.

### PREPARING FOR THE HARVEST.

Success in securing a large crop of honey really depends upon the result obtained in wintering. So it might be stated the proper time to prepare for a bountiful harvest is in the autumn immediately preceding, after the crop for that year has been removed.

In order to have strong colonies in the spring there must be an abundance of stores and a large number of young bees going into winter quarters. Bees do not hibernate in the winter as often supposed and consequently their early flights are not evidences of awakening from a period of inactivity. Brood rearing may begin as early as the latter part of January or forepart of February. With the rise in temperature and opening of the earliest spring flowers, bees begin to get a small amount of nectar and pollen. As the weather becomes warmer flowers increase in number and the bees begin to build up a strong colony. As a usual occurrence in most sections of West Virginia the main honey flow begins with a rush with some of the principal honey producing plants coming in bloom soon after cold weather. Under such conditions the bees are not prepared to obtain a maximum crop. In localities where the beekeeper is so situated it is necessary to feed a little warm syrup made of equal parts of granulated sugar and water about five weeks before the plants producing nectar begin blooming. Since feeding requires certain manipulations which are detrimental it is often discouraged. Much of this can be overcome by placing an empty shallow super without frames or sections over the brood chamber. It is well to separate the brood chamber and super by the use of an escape board with the escape removed. This operation should be done on a warm day so as not to chill the bees. Place a small pan containing pieces of cork or clean chips in the super. Surround this with pieces of discarded clothing or burlap to break up air currents, being careful, however, to allow sufficient room for the bees to reach the pan without being hindered. Bore a hole in the cover directly over the pan just large enough to admit a small funnel. Fit the hole with a cork. When it is desired to add syrup remove the cork, insert the funnel, and pour the syrup directly into the pan. A few apiarists have followed this plan with success. There are several cautions to be observed, the chief of which is not to feed any syrup which has been burnt in the slightest degree. Another, is not to feed syrup any warmer than blood heat, and only in the evening so the bees will not fly and stimulate robbing. In connection with this plan it is advisable to have a supply of rye flour or some other substitute for pollen. The secret of success in producing a maximum crop is having a large force of field bees at the beginning of the honey flow and keeping all colonies strong.

## PRODUCTION OF HONEY.

The obtaining of honey from bees is the primary object of their culture. Bees in gathering nectar and producing honey for their own requirements will store more than they need and this surplus the beekeeper removes. Honey is produced in three forms depending upon the desires of the beekeeper,—comb, extracted and chunk.

### COMB HONEY.

Comb honey is honey stored in the comb by the bees instead of having the bees storing the surplus in large frames. The bees are induced to store it in small wooden sections provided by the beekeeper.

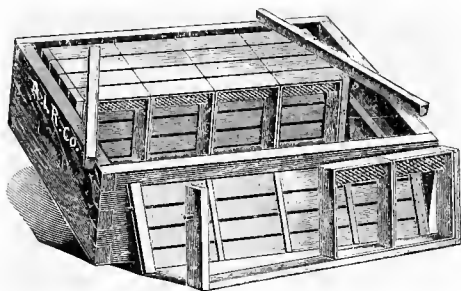

(By A. I. Root Co.)

Figure 15.

Plain Section Super.

beekeepers is a shallow or special comb honey super.

There are different styles and sizes in use. The usual types are 4 x 5 plain section or 4½ x 4½ "bee way" section. The "bee way" section provides passage for the bees, while the use of a plain section requires a fence or separator on each side to provide bee space. There are many styles of super or bodies for holding the sections, but the type used by the majority of the

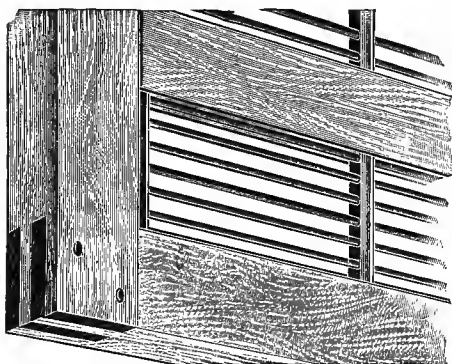

(By A. I. Root Co.)

Figure 16.

Corner of Wood and Wire Queen Excluding Board, Showing Construction.

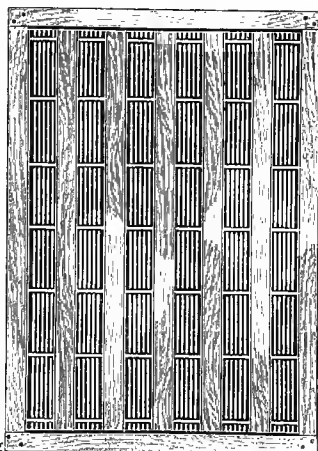

(By A. I. Root Co.)

Figure 17.

Wood and Wire Queen-Excluding Board.

In producing comb honey it is essential to manipulate the colony so as to have a large force of bees ready for the field at the beginning of the honey flow. This requires careful spring management and swarm manipulation. When the brood combs begin to whiten at the top it is time to place on a super.

Supers should always be put in place just before the heavy honey flow begins. To prevent the queen from entering the super and laying eggs, a queen excluder should be placed between it and the brood chamber.

In order to stimulate the bees to begin work in the super as soon as possible to prevent the loss of honey, it is a good plan to put in a few partly drawn sections, left over from the previous year, to serve as "bait." If no drawn sections are at hand a shallow extracting frame on each side of the sections will answer the same purpose. Another good plan, where colonies with sufficient strength refuse to start work above, is to change supers with a colony that has started working in their sections. Supers should always be protected from the direct rays of the sun.

Full sheets of thin foundation in the section produces the finest comb honey. Some beekeepers prefer a narrow strip of starter at the bottom and nearly a full sheet from the top.

Where comb honey is produced, the bees are more inclined to swarm on account of the required crowded condition necessary to produce nice capped sections. When a colony swarms, on which is a super partly filled with honey, the bees abandon this work due to a depletion of the field force.

#### WHEN THE BEES SWARM.

Some apiarists have adopted the plan of keeping one wing of the queen clipped so as to prevent her flying. Then if the swarm leaves the hive the queen can easily be caught and caged. Remove the hive from which the swarm has just issued from its stand and place the newly prepared hive in its stead. The bees soon discover the absence of the queen and return to the old stand and enter the new hive. As the bees are entering, liberate the queen so she enters with the bees. Take the super from the old hive and place it on the new hive. The bees remaining in the old hive can be shaken from the frames in front of the new hive and the frames of brood distributed among the weaker colonies in the apiary. Or replace the frames with capped brood and give the youngest brood to the weak colony. This plan strengthens the weak colonies and eliminates the inclination of swarming without curtailing the production to any appreciable extent.

#### WHEN TO REMOVE THE SECTIONS.

When the first super becomes half full or more and there is an indication of a continued honey flow, raise it and place an empty one on the hive under it. This tiering can be continued along as is necessary but it is advisable to remove the filled sections as soon as they are nicely capped, in order that they may not be soiled by the bees traveling over them. It is essential to give the bees only enough sections to store the



crop, so as not to have a lot of unfinished sections left at the end of the flow. Honey of different colors should not be mixed as it gives the finished sections a bad appearance.

To remove the bees from the super, it may be put over an escape board so that the bees pass down through it and are not able to return. If the escape board is put under the super in the evening and the bees are frightened with the use of a little smoke, the super will be empty of bees in the morning with the possible exception of a dozen or so bees.

After the sections are removed the wood should be scraped free from propolis and packed in shipping cases for market or stored in a small warm dry room. This is essential as honey absorbs moisture readily. In such a place it will gain in quality, while in a damp cellar, basement or refrigerator it gathers moisture and quickly sours.

### EXTRACTED HONEY.

Extracted honey is honey removed from the combs by centrifugal force. Before the invention of the honey extractor in 1865, honey was removed from the comb either by crushing it and drawing off the honey or by melting the combs and allowing it to cool and removing the wax on top. Strained honey as it is sometimes called, produced by these methods, is a rather inferior article in comparison to modern extracted honey.

In producing extracted honey no special super is required. A hive body filled with frames, exactly like in the brood chamber is placed over the brood rearing compartment for the storage of surplus. Some beekeepers prefer a shallow super similar to the comb honey supers,

but equipped with shallow frames instead of sections. When filled with honey these are easier manipulated than the larger super. The use of the standard size frame cannot be denied as being valuable to an apiary as it has the advantage over the shallow frame in interchanging with the brood chamber so that frames of honey from the super can be placed below when the bees require feed. The advantage in using shallow frames other than ease of manipulation is the fact that bees will occupy them more readily. However a good plan would be to use both types in producing extracted honey. The surplus bodies should be put in place before the honey flow begins in order to prevent crowding of the brood chamber which is an act in swarm control.

It is essential to use foundation in the frames, wired same as those used in the brood chamber, in order to secure straight combs. After the first year, the frames will be filled with comb since the honey is removed without any damage to it. Drawn combs can be used year after year. The author has seen combs that have been in use year in and year out for thirty years. The return of drawn comb is the direct advantage of producing extracted honey in preference

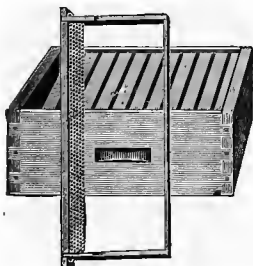

(By A. I. Root Co.)

Figure 18.

#### Shallow Framed Extracting Super.

to comb honey. The bees will enter the super sooner and are not required to use large quantities of honey to produce wax. For that reason alone the bees produce a third to two thirds more honey in a season.

The only real important requirement in producing extracted honey is having the honey thoroughly ripened before removing from the hive. The sealing of all the cells is not important as the caps are removed before extracting.

It is never well to remove any honey from the brood chamber unless the queen is crowded for room in which to lay eggs. This should only be done during the breeding season for it is essential to leave the brood chamber as full as possible in the autumn to furnish winter stores.

In removing the supers the bee escape may be used in the same manner as in comb honey production. Some beekeepers prefer removing the frames without moving the super from the hive. To do this an extra super body is necessary in which to place the frames as they are removed from the super. The bees are first driven down into the chamber below and as each frame is being removed the bees are brushed off by a bee brush.



(By A. I. Root Co.)

Figure 19  
Bristle Brush

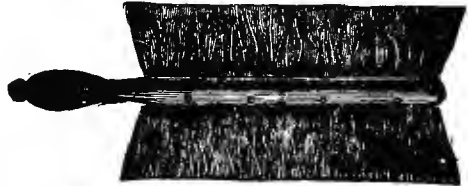

(By A. I. Root Co.)

Figure 20  
Dixie Bee-Brush

After the honey has been removed from the hive it should be carried directly to the honey house so as to prevent robbing.

### PROCESS OF EXTRACTING.

Before the honey can be extracted the combs must be uncapped. This is done either by a steam heated knife or Bingham uncapping knife. This knife has both edges sharp and is beveled on the side coming in contact with the combs so as to prevent the cappings from sticking back to the comb and causing them to drop in an uncapping can or other receiving container. In uncapping, it is essential

to keep the knife hot so as to shave off the cappings and not tear or break the comb.

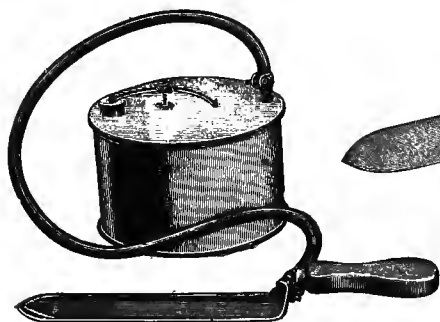

(By A. I. Root Co.)

Figure 21.

Steam Heated Uncapping Knife.

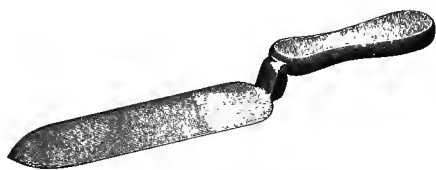

(By A. I. Root Co.)

Figure 22

Bingham Uncapping Knife.



(By A. I. Root Co.)

Figure 23

Four Framed Root Automatic Reversible  
Hand Extractor.

In extracting care must be exercised not to run the extractor too rapidly at first as this may crush or break the comb. It is a good practice to extract some honey from one side, reverse the comb and extract the other side clean and then return to complete the extracting on the first side. This prevents crushing the comb by too great a force by the honey against the bottom of the cells, if the comb is revolved too rapidly in extracting the first side. In placing the combs in the extractor two of about equal weight should be opposite each other to prevent swinging of the extractor thus preventing excess wear on the machine and making it

easier for the operator. The honey is thrown against the side of the can and runs down to the bottom. An opening is provided at the bottom which is usually equipped with a specially constructed gate-like arrangement for quick opening and closing.

After extracting, the combs are replaced in the super and returned to the bees to be refilled if nectar is still being produced or returned to be cleaned and then removed for storage. If no nectar is being gathered the empty combs may be placed on a hive as the full ones

are removed. Where there is a dearth of nectar the combs should be kept in the honey house until the evening before returning. If not done it is likely to cause robbing and excitement in the apiary. If the combs are returned just to be cleaned six or more can be put over one colony. In storing surplus combs it is necessary to place them in a light, well ventilated room or in the hive bodies where they can be watched and fumigated when necessary to prevent their destruction by wax moth larva.

The extracted honey should be drawn from the extractor run through a strainer and stored either in a large galvanized can or other open vessels. The container should be covered with a cloth to keep out dust and insects. It is essential not to store extracted honey in a damp cool cellar basement or room as it readily absorbs moisture. Keep it in a warm dry place for several days before preparation for market.

#### WHAT TO DO WITH THE HONEY CAPPINGS.

The honey cappings collected in the uncapping can should be separated from the honey by straining the honey through a close meshed wire strainer or cheese cloth sacks. The cappings should be thoroughly washed with cold water and then melted. In order to conserve the honey in the washings it can be used in making vinegar.

#### SOURCES OF NECTAR.

Every beekeeper should familiarize himself with the honey producing flora of his locality. Even if it is difficult at times to ascertain the



Figure 24.

Dandelion Furnishes Nectar and Pollen in the Early Spring.

sources from which bees secure nectar; every effort should be made to learn the principal nectar producing plants in the vicinity of the apiary as well as the approximate dates of beginning and ending bloom of each honey plant. Such information is valuable in order to stimulate the bees in such manner as to have them reach their maximum strength when nectar is being produced in great quantities to insure a large surplus of honey.

West Virginia is situated in the heart of the Appalachian or deciduous leaved forest region. As would be expected the principal nectar producing plants are trees. The more important among the great number of varieties that abound in this region are three species of basswood or linn, tulip trees or poplar, sourwood, sumac, black



(By Dadant)

Figure 25.

**Black Locust an Excellent Honey Plant Found Abundant in West Virginia.**

locust, Judas tree, maples, black gum, holly, chestnut, willows, and a wealth of shrubs such as rhododendrons, Kalmias and Azaleas, besides a great variety of wild and domesticated fruit trees and shrubs. In connection with the trees there is an abundance of herbaceous plants such as clovers, buckwheat, milkweed, Vipers bugloss, golden rod and asters.

It seems that no one plant stands out as the most important nectar producer anywhere in the state. In some localities, especially along

the Ohio river, the different clovers are probably most important. White clover, where it occurs in quantity, produces an excellent honey in color and flavor. Alsike clover is now being quite generally grown and is an excellent nectar yielding plant. Red clover, commonly grown by most farmers under ordinary conditions, is not a surplus plant. Sweet clover, which is sometimes considered a weed, is becoming more and more abundant every year especially in the extreme eastern counties. This is an excellent plant for the beekeeper.

The bloom of apple, peach, plum and cherry are very important sources of nectar, however, not often yield any appreciable surplus, but the colonies are stimulated by such early bloom to early brood rearing. Even if the original large area of basswood has been cut



(By A. I. Root Co.)

Figure 26.

West Virginia's Most Popular Honey Plant, Basswood or Linden.

for lumber, a second growth springs up in a few years and blooms more profusely than the original trees. Sourwood is rather widely distributed and yields nectar in great quantity, which produces a water white honey with an aromatic flavor. Sumac, wild raspberry and wild blackberry are important in some localities, the former yields an amber colored honey of fine flavor. Blue Devil is important especially in the valleys of the eastern counties.



Figure 27.

**A MORE ANCIENT MARINER.**

The swarthy bee is a buccaneer,  
 A burly velveteed rover,  
 Who loves the booming wind in his ear  
 As he sails the seas of clover.

A waif of the goblin pirate crew,  
 With not a soul to deplore him,  
 He steers for the open verge of blue  
 With the filmy world before him.

His flimsy sails are abroad on the wind  
 Are shivered with fairy thunder;  
 On a line that sings to the light of his wings  
 He makes for the land of wonder.

He harries the ports of the Hollyhocks,  
 And levies on poor Sweetbrier;  
 He drinks the whitest wine of Phlox,  
 And the Rose is his greatest desire.

He hangs in the Willows a night and a day;  
 He rifles the buckwheat patches;  
 Then battens his store of pelf galore  
 Under the tautest hatches.

He woos the poppy and weds the Peach,  
 Inveigles Daffodilly,  
 And then like a tramp abandons each  
 For the gorgeous Canada Lily.

There's not a soul in the garden world  
 But wishes the day were shorter,  
 When Mariner B. puts out to sea  
 With the wind in the proper quarter.

He pilfers from every port of the wind,  
 From April to golden autumn;  
 But the thieving ways of his mortal days  
 Are those his mother taught him.

He looks like a gentleman, lives like a lord,  
 And works like a Trojan hero;  
 Then loafes all winter upon his hoard,  
 With the mercury down at zero.

BLISS CARMAN.



# A PARTIAL LIST OF SOME OF THE IMPORTANT BEE PLANTS IN WEST VIRGINIA

COMMON NAME	SCIENTIFIC NAME	PERIOD OF BLOOM	VALUE	DISTRIBUTION
Willows	<i>Salix</i> spp.	February-March	Pollen some nectar	Common throughout State.
Red Maple	<i>Acer rubrum</i>	March-April	Pollen some nectar	Common throughout State.
Arbutus	<i>Epigaea ripens</i>	March-May	Slight	Common throughout State.
Peach	<i>Amygdolus persica</i>	April	Important as nectar	Common throughout State. Eastern Panhandle.
Cherry	<i>Prunus</i> spp.	April-May	Important nectar & Pollen	Common.
Redbud (Judas tree)	<i>Cercis canadensis</i>	April	Contributing nectar and pollen	Rather common.
June Berry	<i>Amelanchier canadensis</i>	April	Slight	Common.
Hawthorn or Haw	<i>Crataegus</i> spp.	April-May	Pollen-Nectar	Very common throughout state.
Apple	<i>Malus malus</i>	April-May	Contributory to surplus	Extremely common in large area in Eastern Panhandle, along Ohio and Kanawha valleys.
Dandelion	<i>Taraxacum</i> spp.	Throughout year most abundant	Valuable pollen nectar	Very common.
Azalea (Pink)	<i>Azalea nudiflora</i>	April-May	Some nectar pollen	Common in the Mountains.
Huckleberry	<i>Gaylussacia</i> spp.	May-June	Nectar and pollen	Common in Mountains.
Tupelo, Pepperidge, sour or black gum	<i>Nyssa Sylvatica</i>	May	Valuable source of nectar yields surplus	Common in forested areas.
Wild raspberry	<i>Rubus</i> spp.	May	Valuable for surplus	Common in burnt over areas.
Tulip tree or Poplar	<i>Liriodendron tulipifera</i>	May-June	Extremely valuable as a surplus plant	Common throughout the wooded area of this State.
Black locust	<i>Robinia</i>	May-June	Important surplus plant	Widely distributed throughout the state.
Sunac	<i>Rhus</i> spp.	June	Yields nectar abundantly	Common throughout the state.
Strawberry	<i>Fragaria Virginiana</i>	April-June	Important in nectar	Very common throughout state.
Alsike clover	<i>Trifolium hybridum</i>	June	Very valuable to beekeepers increasing in popularity	Abundant in agricultural communities.
Holly	<i>Ilex glabra</i>	June	Important source of pollen	Widely distributed in mountainous section
White clover	<i>Trifolium ripens</i>	June-July	Chief surplus in certain sections	Important only in Ohio valley and northern countries.
Chestnut	<i>Castanea dentata</i>	June-July	Some nectar and pollen	Common throughout state.
Chinquapin	<i>Castanea pumila</i>	June-July	Yields but of poor flavor	Frequent throughout state.
Basewood or Linn	<i>Tilia</i> spp.	June-July	Heavy yielder of excellent surplus	Common in wooded areas of state.
Sourwood	<i>Oxydendrum arboreum</i>	June-July	Very important yields extra abundant	Common in wooded area.
Swamp Milkweed	<i>Asclepeas incarnata</i>	July-August	Surplus in some localities	Abundant in valleys throughout the state.
Sweet clover	<i>Millilotus alba</i>	July-September	Dependant for surplus	Frequent throughout state.
Blue Devil or Vipers bugloss	<i>Echium vulgare</i>	June to September	Important	Common to Northern and eastern sections of state.
Buckwheat	<i>Fagopyrum esculentum</i>	August-September	Excellent yielder in certain years	Mostly grown in Northeastern section of state.
Golden rod	<i>Solidago</i> spp.	August-September	Contributory	Common throughout state.
Asters	<i>Aster</i> spp.	August-September	Yields surplus	Common throughout state.
Willowherb	<i>Epiloccum augustiflorum</i>	July to frost	Yields surplus to abundance	Common only in burnt over areas.

### BEE DISEASES.

There are three infectious diseases of bees that attack the young brood. Of the three, the greatest losses arise from two, American Foul Brood and European Foul Brood. The third, which rarely causes any serious losses, is Sac Brood. Each disease has its characteristic appearance and is caused by separate and distinct organisms. Foul brood is destructive and causes serious losses, however, recent legislation has brought about a systematic inspection in all localities having serious outbreaks of these diseases and they are losing their destructiveness just as rapidly as beekeepers learn how to recognize and treat diseased colonies.

#### AMERICAN FOUL BROOD, ITS CAUSE, SYMPTOMS AND TREATMENT.

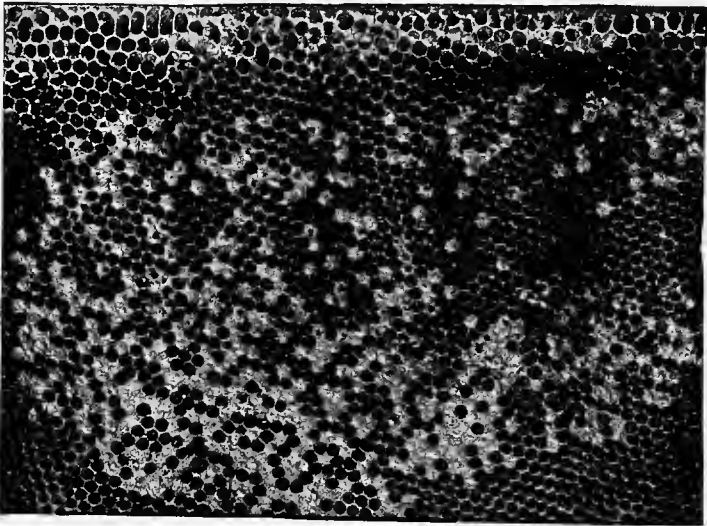

Figure 28.

Brood in Last Stages of American Foul Brood.

American foul brood is caused by an organism called *Bacillus larvæ*, which attack the young larvae about the time they begin to fill the cells, have ceased feeding and begun pupation. Usually the disease attacks only worker brood. Race of bees, season or climate seems to have no effect on the virulence of this disease.

#### SYMPTOMS.

The first indications of infection are, a slight brownish discoloration, the loss of the rounded appearance of the healthy larvae and a reversal of the larvae in the cell. The larvae slowly settles down on the lower side of the cells and become a light chocolate brown in color. As they

gradually dry down they take on a darker color and finally become a dark brown scale on the lower wall of the cell. If a toothpick or match stick is inserted in the decaying mass and slowly withdrawn, some of the larvae remains adhered to it and are drawn out into a thread which sometimes extend for two or three inches before breaking. This ropy feature is one characteristic in diagnosing the disease. The decaying larvae usually give off a penetrating odor similar to that of heated glue. In severe outbreaks the larvae are attacked after being sealed. In such cases, the cappings are frequently perforated and sunken. Scattered sunken cells left after the healthy brood emerge together with the glue pot odors are sufficient evidence of this disease.

### TREATMENT.

The treatment of foul brood is very similar to "shook swarming," only narrow strips of foundation are used instead of drawn comb or full sheets in preparing the hive to receive the bees. The old hive is removed a foot or two from its stand and the prepared hive placed in its stead. The bees may either be shaken directly into the prepared hive, after removing several frames from the center of the hive or place newspapers in front of the hive and shake the bees on it and later burn the paper. A third empty hive body should be provided to receive the combs after the bees have been dislodged. It is essential to leave this tightly closed in order to keep out the bees. After all the bees have been shaken, replace the frames with starter removed to make space for shaking. Close the hive, contract the entrance and put a queen trap at the entrance to prevent the queen from leaving the hive. Shaking treatment in the open should be undertaken only when nectar is being gathered by the bees. Otherwise operate under a tent of mosquito netting large enough to permit easy movement of the operator. Some beekeepers prefer placing a frame of drawn out comb or foundation in the center of the hive and removing it twenty-four hours after treatment to secure all infested honey the bees might have carried with them.

If there is a considerable amount of capped brood in the infected combs it can be saved by placing the frames over a weak diseased colony. This allows the young bees to go below as they emerge, thus strengthening the colony which should also be treated later. In case there is not enough brood to justify saving, the combs should be carried away and rendered as soon as possible by thorough boiling in hot water. Sometimes it is advisable to burn the comb, frames, and all materials, to prevent spread of the contagion.

If the honey is saved, it should be used in home consumption and never sold. Never under any circumstances allow it to come in contact with the bees. The hive bodies should be scorched until the wood is charred. This can be done either with a painter's torch or stacking them on top of each other and placing a quantity of straw or excelsior, in the bottom, saturated with kerosene and ignited. After burning for a few minutes place a cover over the top to smother the flames.

## EUROPEAN FOUL BROODS, ITS CAUSE, SYMPTOMS AND TREATMENT.

European foul brood is caused by an organism known as *Bacillus Pluton*. This disease attacks the larvae at a much earlier stage than American foul brood, while the larvae are still curled up at the base of the cell.

This disease is more destructive during the spring and early summer than at any other times, often disappearing later in the summer or during a heavy honey flow. Italian bees resist the ravages of this disease better than any other race. It spreads faster, is more destructive, and a larger percentage of colonies are affected than with American foul brood.

### SYMPTOMS.

The earliest indication is a slight yellowish or gray discoloration of the larvae, which at the same time move about uneasily in their cells. After death the larvae usually fall away from the bottom of the cell, losing their rounded opaque appearance and become translucent. Later the color changes to a decided yellow or gray, losing their translucency and become a moist collapsed mass very much the appearance of being melted. Finally all that is left of the larvae are grayish brown scales against the bottom of the cells or a shapless mass on the lower side wall. The scales are very seldom black and are not adhesive as in the American Foul Brood, but are easily removed and the bees carry out a great many in their effort to clean house.

Decaying larvae which have died of this disease are usually not rosy and the odor is very scarce only in severe cases when a sour odor is present similar to that of yeast fermentation.

### TREATMENT.

Where the beekeeper is inexperienced in handling diseased bees, European Foul Brood should be treated in the same manner as American. It has been previously stated that Italian bees are able to withstand European foul brood better than other races. In regions where this disease is prevalent it is recommended that apiaries be requeened with young vigorous Italian queens of good stock. This should always be done whether the infected bees have been given the shaking or other treatment.

It has been found by many beekeepers that the removal of the queen and keeping the colony queenless for a period of twenty days, and at that time requeening with a young tested Italian queen, often results in the disappearance of the disease. This treatment should only be used by the experienced beekeeper.

### SAC BROOD.

When attacked by this disease the larvae die about the time of sealing, usually lying on their backs with their heads turned upward. The color varies from light yellow to brown. The body swells and the contents become watery and the head black and hard. This disease does not

ordinarily cause any serious loss and as a rule no treatment is necessary. The real seriousness of the disease is in mistaking it for American or European foul brood and treating accordingly.

#### DISEASE OF ADULT BEES.

Since very little is known concerning the causes of diseases affecting the mature bee very little treatment can be given.

#### DYSENTARY.

Sometimes bees, after being confined for a long time during the winter, accumulate such an unusual amount of indigestible material that they are unable to retain their fecal matter until flight. The hive and comb are then spotted and this condition is known as dysentery. The treatment recommended is to provide light colored honey for wintering.

#### PARALYSIS OR MAY DISEASE.

In this disease the abdomen becomes distended, the bees crawl about as half paralyzed and appear to be in great misery. This condition often ceases in a few days but occasionally colonies affected lose so many bees that they become worthless. Sometimes the queen contracts the disease and dies. Since the direct cause is unknown no treatment can be given.



Figure 29.

Winter Extracts its Toll. Notice Empty Hives in Background. Ten Colonies Were Left Out of One Hundred Going into Winter. Losses Due to Lack of Protection.

### SPRING DWINDLING.

This name is applied to a condition in the spring when the loss of adult bees is at a more rapid rate than can be replaced by the emerging brood. It is undoubtedly caused by a weakened condition by poor wintering.

### ENEMIES OF THE BEE.

The enemies of the bee are not numerous. Occasionally a bird cultivates a taste for bees; the chief offender, however, is the King Bird, but their damages are so small that it hardly deserves mention. Skunks sometimes are troublesome in making raids on the apiary at night. Mice at times cause damage, especially during the winter, by making their nests in the hives. Ants often make their nests between the cover and top board, to take advantage of the heat from the bees. They are easily driven away by scattering powdered sulphur or salt where they nest.

### THE BEE MOTH.

The most prevalent enemy of bees is the bee moth. There are two species: the greater wax moth (*Galleria mellonella*) and the lesser wax moth (*Achroia grissella*). The larvae of the moth destroy the combs by burrowing through them, constructing silken tunnels as they go. Colonies that are queenless or weakened by disease are often entirely destroyed by the ravages of the larvae. They are especially destructive to stored combs. Since the moths can not stand low temperatures it is best to store surplus combs in cold rooms.

In controlling the bee moth there is only one rule and that is to keep all colonies strong and not expose surplus combs in open places. Moths discovered in combs can easily be destroyed either by sulphur fumes or bisulphide of carbon. The use of the latter requires extreme caution and should be kept away from fire or flame as it is highly inflammable and explosive. By burning sulphur in the honey house all moths and flies will be killed without injuring the honey. This should be done occasionally in order to prevent serious outbreaks of the bee moth.

### WINTERING.

Since bees do not hibernate, as do many insects, it is necessary for them to generate a certain amount of heat in order to survive the winter. To generate heat they must have an adequate supply of good honey. Honeys of the lighter color are desired in preference to the dark honey because of the amount of indigestible materials they contain. "Honey-dew" honey should never be left in the hives for winter supplies. Colonies short of stores should be supplied with a syrup of granulated sugar. Every colony, in order to winter well, should have no less than thirty pounds of honey.

Where colonies are wintered out of doors, it is necessary to provide

extra protection to reduce the energy expended by the bees to keep the temperature from falling below 57 degrees.

In order to protect the bees from changes of temperature the hive or group of hives should be placed within a box about eight to ten inches larger in every way than the hive or hives, and pack the intervening space with dry leaves, dry saw dust, or dry planer shavings. A small tunnel through the packing material allows passage way for the bees to the entrance of the hive. It is essential to cover the top with some roofing material to prevent the packing from becoming wet by rains or snow. The rule to follow for outside wintering is to leave abundant stores, pack early and heavily, protect from the wind and unpack late.

Where cellar wintering is practiced, bees should be taken in about the time the weather becomes too cold for further flights. It is well to leave them in the cellar until the warm days make their appearance in the spring. Some beekeepers prefer leaving them till the maples bloom before placing them on their summer stands. It is essential where bees are stored in a cellar that a constant and uniform temperature of at least 45 to 50 degrees be maintained. Properly ventilated to rid the cellar of surplus moisture and avoid crowding.

#### LITERATURE ON BOOKKEEPING.

The beekeeper will find at least one good journal and one or more books relating to apiculture to be indispensable.



Figure 30.

Literature That Should Be Found in Every Beekeeper's Library.  
Journals.

American Bee Journal, published at Hamilton, Illinois, and Gleanings in Bee Culture, published at Medina, Ohio, are two publications issued in the United States.

#### Books.

There are a number of books on beekeeping from which to select. They may be obtained from any dealer in beekeeping supplies, publishers of the above journals, or book dealers.

A, B, C and X, Y, Z of Bee Culture, A. I. and E. R. Root, A. I. Root Company, Medina, Ohio.....	\$2.50
Beekeeping, Dr. E. F. Phillips, The MacMillan Co., New York City .....	2.00
Productive Beekeeping, Frank C. Pellett, J. B. Lippincott Co., Philadelphia, Pa.....	2.00
First Lessons in Beekeeping, C. P. Dadant, American Bee Journal, Hamilton, Illinois.....	1.00
Thousand Answers to Bee Questions, American Bee Journal, Hamilton, Ill. ....	1.00
Langstroth-Dadant on the Honey Bee, L. L. Langstroth, American Bee Journal, Hamilton, Ill.....	1.50

Catalogs of manufacturers of bee supplies will be found to contain much valuable information and should be included in the beekeeper's library.

The following publications relating to bee culture are for free distribution and may be obtained by addressing the Secretary of Agriculture, Washington, D. C.

Farmers' Bulletin No. 442—Treatment of Bee Diseases.

No. 447—Bees.

No. 503—Comb Honey.

No. 695—Outdoor Wintering of Bees.

No. 653—Honey and Its Uses.







Cornell University Library

**Beekeeping for West Virginia**



3 1924 003 429 366

man

