

### COMPLETE SET OF X-RAY APPARATUS,

Consisting of Rukmkorff Coil (oil insulation) ; Rotary Contact Breaker with Motor ; Condenser ; Crookes Tube and Stand ; Diaphragm ; Fluoroscope ; Batteries and Switches.

THE  
A B C  
OF THE X RAYS

BY  
WILLIAM H. MEADOWCROFT  
...  
AUTHOR OF "THE A B C OF ELECTRICITY"

---

*ILLUSTRATIONS BY H. E. FANSHAWE.*

---

NEW YORK  
THE AMERICAN TECHNICAL BOOK CO.  
45 VESEY STREET

COPYRIGHTED, 1896,  
By WM. H. MEADOWCROFT.

## PREFACE.

THE following pages have been written with a view of offering some assistance to two classes of readers, namely, those who desire to add to their stock of general information, and others who wish to pursue for themselves a line of investigation and experiment in the fascinating domain of the mysterious X rays.

Many of those who will desire to make a special study of the subject or make practical use of Prof. Roentgen's discovery will probably have had no occasion to acquire any special knowledge of electrical matters, and will, therefore, be at a loss to know what apparatus is needed, having due regard to the conditions by which they are surrounded.

The aim has been, therefore, to make all explanations as full as possible and as simple as is consistent with statements of technical matters. A careful endeavor has also been made to include in the following chapters sufficient information

Wesley T. Hammer '18, Friend

5-24-65

UPP.  
829A

to enable the layman to choose the apparatus most suitable to his needs as well as to operate it and obtain successful results therefrom.

W. H. M.

OCTOBER 15, 1896.

## CHAPTER I.

### INTRODUCTORY.

ALTHOUGH the main object of this book is to present to the reader a practical explanation of apparatus and methods employed in producing and utilizing the X rays, the present chapter will be treated as a general introduction of the subject. The object in so doing is to set forth a general outline of Professor Roentgen's discovery and, incidentally, to correct certain popular misconceptions that have arisen as to some of the phenomena and the methods of their utilization.

Looking back along the years of the present century, we see within their bounds the greatest development and progress that has blessed the world since the beginning of time. A mere enumeration of the discoveries and inventions contributing to comfort, safety, and convenience that have been made since the year 1800 would fill many large volumes. If we should single out from this host only a few of those that are conspicuous by their greatness, such as the Intro-

duction of Illuminating Gas, the Steam Engine, the Railroad, the Steamboat, the use of Anæsthetics, the Electric Light, (Arc and Incandescent), the Electric Railroad, the Electric Transmission of Power, and the X rays, we cannot but be powerfully impressed with the wonderful progress made within the past years of the nineteenth century.

It seems fitting that the discovery of the wonderful phenomena of the X rays should be made as the hands upon the clock of the century are completing their round, as it was the logical result of research and experiment founded upon the most advanced kind of intellectual and scientific study and attainment.

How far reaching this discovery may ultimately prove to be in the arts and sciences it is impossible at this time to predict, but within the few months in which it has become known and practiced, the wonderful effects have been practically applied to the alleviation of much suffering, and we have at this moment at our command a mysterious power for good that it would have seemed sheer folly to even hope for only one short year ago.

The discovery of the X rays was made towards the end of the year 1895 by Professor William



Konrad Roentgen, professor of Physics at the Royal University of Wurzburg, in Germany. He had for many years made a study of phenomena arising from the action of currents of electricity in glass tubes more or less exhausted of air, known as Geissler, Crookes, or Vacuum tubes. In the year 1894 some new phenomena in this line of experiment had been noted by Professor Lenard, an assistant of Hertz.

In the course of a study of these phenomena by Professor Roentgen, he discovered that an effect was produced by the rays emanating from a Crookes tube, which was being excited by an electric current, similar in many respects to the effect that would be produced by rays of light, but with the wonderful difference that the new rays would penetrate flesh, blood, and muscle and many thicknesses of paper, cloth, leather, wood, rubber and other substances which are opaque to ordinary light rays.

The first announcement of this great discovery was received by the world with incredulity and some amusement, but this was quickly turned to astonishment and wonder by subsequent announcements of practical results having been obtained by other scientists on following the methods employed by Professor Roentgen.

It is not deemed necessary to enter into a more detailed account of the history of this discovery than the outline above given, as the newspapers, magazines, and technical journals have already given much space to the subject. The following pages will therefore be devoted to a brief explanation of the X ray phenomena, followed by a description of the various items of apparatus employed and of the methods of using the same to produce the effects which are now becoming so generally known.

The generation of the X rays is at the present time wholly electrical. It is possible that there may later be discovered some other means of producing them, but at this day there seems to be no well authenticated fact to prove that there has been any other source of generation discovered.

Like the electric current itself, the mysterious X rays are invisible; their presence being known only by the effects produced under proper conditions. There has been a popular misconception that the X rays proceed from a glass vacuum-tube giving a light of dazzling brilliancy, but such is not the fact, for very frequently the vacuum-tube under excitation will glow, or fluoresce, so faintly that the whole illumination would not

be sufficient to enable one to tell the time by a watch and yet there might be rays of such strength as to affect a photographic plate in a few seconds through a piece of wood, cardboard, or rubber of considerable thickness.

Although the X rays in their effects closely approximate ordinary light rays, there are such differences that scientists have not as yet been able to properly classify them. Their exact nature is at present unknown. Professor Roentgen himself gave the new rays the name of X, (or unknown), rays, by which name they have since been generally designated. Research and experiment will, however, possibly result in ultimately determining the question of their proper classification. The most recent investigations as to the nature of the rays tend to leave little doubt that they are transverse vibrations in the ether, like those which constitute light and radiant heat but of very much higher pitch or excessively short length of waves.

One instance will suffice to make the above differences clear to the reader. It is well known that rays of light may be deflected, refracted or condensed, but not so with the X rays. They proceed only in straight lines normal to the point at which they are produced. Take, for instance,

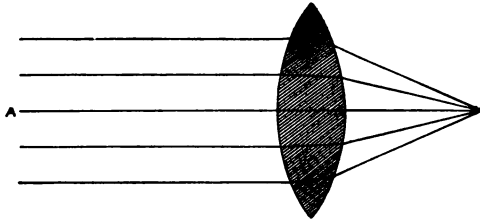

FIG. 1.

an ordinary magnifying glass which is simply a glass lens of convex shape as shown in Fig. 1. The rays of light proceeding from A strike the lens and are condensed and brought to a focus, or point of meeting, on the other side of the lens. This is one of the principles applied in the ordinary photographic lens, making it possible to condense the light rays proceeding from a large area and project them in greatly reduced form upon a sensitized plate in the camera. If, on the other hand, such a lens should be placed in the path of the X rays, they would proceed through it in straight lines (if indeed they could penetrate the glass at all, glass being more or less opaque to the rays as we shall presently learn), and would neither converge nor diverge.

Thus far we have found :

(1) that the generation of X rays is from electrical sources.

(2) That the X rays are invisible.

(3) That they proceed in straight lines and, so far as present discovery goes, cannot be reflected, refracted, or condensed, but can be diffused.

Let us now take a preliminary glance at one of the methods employed in producing the rays, reserving more complete details for a further chapter.

The appliances used consist of (1) some form of apparatus which will give a current of electricity of very high potential, as for instance, a Ruhmkorff induction coil ; (2) a mechanical contrivance called a "Contact breaker" for interrupting with great frequency the continuity of the circuit ; (3) a condenser for accumulating and rapidly discharging accumulations of electric energy ; (4) a Crookes vacuum tube ; and (5) a battery, or other source of electric current. More particular explanation of these various items of apparatus will be found on other pages of this book.

If the electric current be applied to the coil with contact breaker and condenser attached, and the secondary terminals of the coil be separated within certain distances, leaving only the air between, bluish-colored, snappy, lightning-like sparks will jump across from one terminal to the other at such frequent intervals as to appear like

a continuous stream. The length of these sparks will depend largely upon the amount of wire upon the coil. In ordinary coils for this work the sparking capacity will vary from one to twelve or more inches in length. These sparks are of the character just described only when they occur in the open air, and their curious zigzag form is said to be due to the current taking a path through the particles of air having the least resistance.

Suppose, however, that we take these two secondary terminal wires from the coil and seal them into a glass bulb or cylinder so that the ends of such wires will project therein. These ends would thus be known as "electrodes." If the bulb were not exhausted of air, the same character of discharge will take place between the two electrodes when the coil is energized by an electric current.

Now, if the air be partially exhausted from the bulb so as to make a moderately low vacuum, say a pressure of three thousand one-millionths of an atmosphere (an atmosphere being equal to a pressure of 15 pounds to the square inch), a very different appearance will be noted when the coil is once more energized. Instead of a stream of sparks jumping across from one electrode to the

other, the whole bulb will become filled with a purplish-colored cloud having a rapidly vibrating or travelling movement. This occurs by reason of the molecules of air remaining in the bulb being driven off from one electrode towards the other, and coming into violent contact with each other, the force of the collision of these molecules produces light.

If now the tube be exhausted to a high degree of vacuum, say, to one one-millionth of an atmosphere, a new set of phenomena is developed on discharging the current from the coil into the tube. The purplish cloud has disappeared and the interior of the tube is clear, but the glass itself has assumed a beautiful fluorescence caused by the bombardment against it of the remaining molecules of air. This is now a Crookes vacuum tube.

The fluorescence will be most noticeable and brilliant at that part of the glass tube that is opposite the negative, or cathode, electrode, and it is from this part of such a tube that the X rays proceed in greatest abundance. We shall see in a later chapter that modifications of this simple form of Crookes vacuum tube have recently been made, providing for a special bombardment surface, within the tube, with the result of obtaining

a much greater abundance of the rays, together with less diffusion and, consequently, a greater degree of sharpness of definition, in the shadows produced by them.

We find, then, that the X rays are projected from a place or point in a highly exhausted glass tube that is directly opposite the negative, or cathode, electrode, and that this place or point may, but need not necessarily be, the glass of the tube itself.

Having brought the reader to the point where the X rays are produced, let us now see in what manner and by what methods we can ascertain definitely that they are present.

It requires no special methods to ascertain when ordinary light rays (sun or artificial) are present, for it involves only a radical difference which is apparent to every one who is possessed of eyesight, namely, the difference between darkness and light. The fact of the X rays being invisible but producing some effects similar to, and in some aspects more powerful than, effects produced by light rays, presents apparently a somewhat paradoxical state of things.

Comparisons with known standards may in many cases be advantageously made in explaining new phenomena, but in this case there are



no standards by which the new set of phenomena incident to the X rays may be strictly comparable.

We shall endeavor, therefore, to make the explanation in the simplest possible manner.

There are at present only three ways in which the presence of the X rays can be ascertained. One of the strongest characteristics of X rays is their power of discharging electrified bodies or surfaces exposed to them. This, in fact, is the *most* sensitive way of detecting them. Another way is by means of the ordinary sensitized photographic plate, and the other is through the fluorescence of certain crystalline chemical salts when brought within the influence of the rays.

It will be necessary only to discuss the latter two, and taking these in their order, we will first deal with the photographic plate, and at the start it will be well to correct the popular error that an ordinary photographic camera is used in obtaining pictures with the X rays. A camera is not necessary, in fact no use could be made of it in this connection, as the rays cannot be condensed or refracted.

A picture of any object obtained by means of the X rays is not a photograph, strictly speaking, although it is made upon a sensitized plate and developed and printed in the manner usually

followed in making photographs. As defined in the dictionaries, photography is the "fixing of an object or objects by chemical *rays of light* upon certain salts sensitive to light," and as



PHOTOGRAPHY.

ordinarily practiced, includes the use of lenses by which the objects photographed may be focussed on the sensitized plate on a smaller or greater scale. An X ray picture of any object, (or "radiograph" as it is generally termed), cannot in the first instance be made any larger or smaller than the object itself, because lenses cannot be successfully used to condense the rays, and therefore, a radiograph is practically a life-size *shadow picture* of the object. A radiograph, once taken, can, however, be *photographed* by rays of light in the ordinary way; and thus a new picture of the object, increased or diminished in size, may be obtained.

If we should take a sensitized photographic plate and place an opaque object upon it, as, for instance, a hand, and expose it for a few seconds in daylight, the rays of light would not reach that part of the plate covered by the hand. Upon developing the plate there would be seen clear the shape, or shadow, of the hand, while all

around it the plate would be dark owing to the rays of light having affected this portion. No part of the bones, muscles, or other interior portions of the hand would be visible upon the plate, as the rays of light would not penetrate the flesh and blood, all portions of the hand being to a very great extent opaque to light rays. Such a picture as this would be termed a *photograph*, having been obtained through the agency of light rays. A print from this photograph made upon paper in the regular way would show simply a black shadow of a hand, while all around it would be clear white, just as a hand might be seen outlined upon a white window shade if a light were placed behind it. That part of the photographic plate which in prints from it is white is the part that has been directly acted upon by the rays of light.

The X rays allowed to fall directly upon a sensitized photographic plate will affect it in the same way as it would be affected by light rays. A plate so exposed would, after development, yield prints of a clear white.

Now, for comparison, let us expose two sensitized plates, one to ordinary light rays and the other to the X rays, first placing over each plate, so as to cover it entirely, a piece of wood, a book,

a sheet of rubber, or a thin sheet of the metal aluminium. On developing and printing these two plates we find that the one exposed to the light rays will print black, thus showing that these rays have not penetrated the substance interposed. The development and printing of the one which was exposed to the X rays will, however, result in a clear white print, proving thereby that the plate was acted upon and that the substances above named were no obstacles to the passage of the X rays.

Although the X rays will penetrate the above named articles, and many others, it is to be noted that they do not readily penetrate *all* substances, and that among those that are fairly opaque are bone, glass and almost all the metals. By reason of that fact we are enabled to make examination of the bones in a living body and we may also locate foreign opaque substances which may by accident have entered the human frame.

Let us now expose one more sensitized plate by way of illustration; this time to the X rays. We will wrap it up in black paper, or enclose it in a plate-holder, sliding a cardboard or rubber cover over the latter. Now we will place it on a table, lay a hand upon the covering of the plate and produce the X rays by means of a suspended

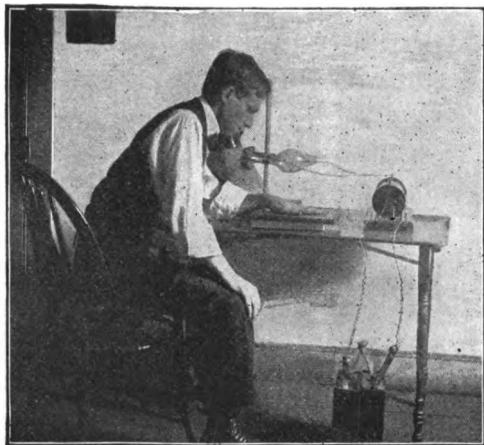

RADIOGRAPHY.

Crookes tube. In a few minutes the excitation of the tube is stopped and the plate taken away and developed. Upon printing this we find that that part of the plate not covered by the hand is a clear white. We also find that the X rays have penetrated entirely, the muscles, and to a great extent the flesh, blood, and nails, leaving only a faint shadow of the outline of the hand. The rays have not, however, penetrated the bones, consequently the plate immediately beneath them has not been affected (or, if at all, very slightly), and therefore, as they show in dark relief, we have a strong picture of the bones of the hand.

Had there been a piece of metal such, for instance, as a bullet or a needle, embedded in the hand, it would also have shown, these substances being also opaque to the X rays.

Thus we can to-day obtain pictures of the bony structure of any part of the body and show the presence not only of foreign substances of a metallic nature, but also of calcareous deposits or other substances that are opaque to the X rays. Broken bones, or those improperly set after being broken, as well as dislocations, can also be disclosed as clearly as if the flesh were stripped from that part of the body in which they are located.

A great many experiments have been tried and much thought has already been expended in the direction of obtaining clearly defined radiographs of the heart and other organs, but as these are not sufficiently opaque to the X rays it cannot be said that entire success has yet been achieved in this direction.

A recent cable from abroad announces that a radiograph of the stomach and intestines of a person has been successfully obtained by having the person first drink a quantity of a harmless solution of a chemical nature impervious to the X rays and then making the usual exposure.

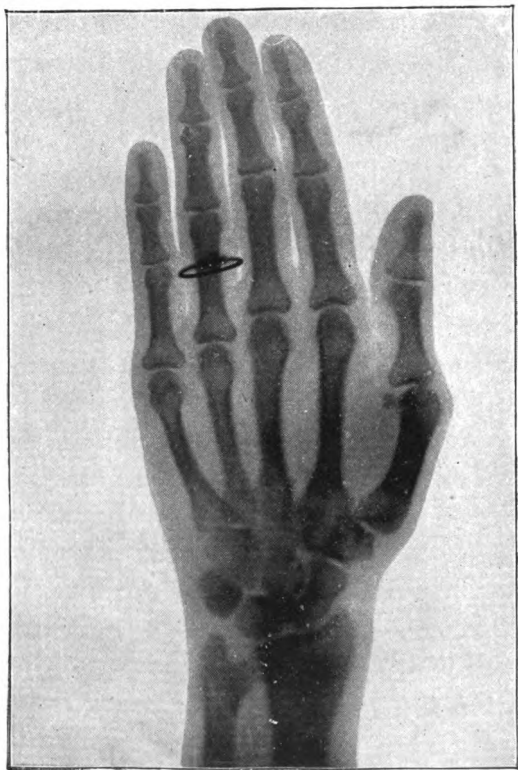

Made by the author with Thomson Double-focus Tube and Inductorium.

Time of Exposure 2 minutes 50 seconds.

Distance from Tube 12 inches.

Inductorium working on 5 inch spark.

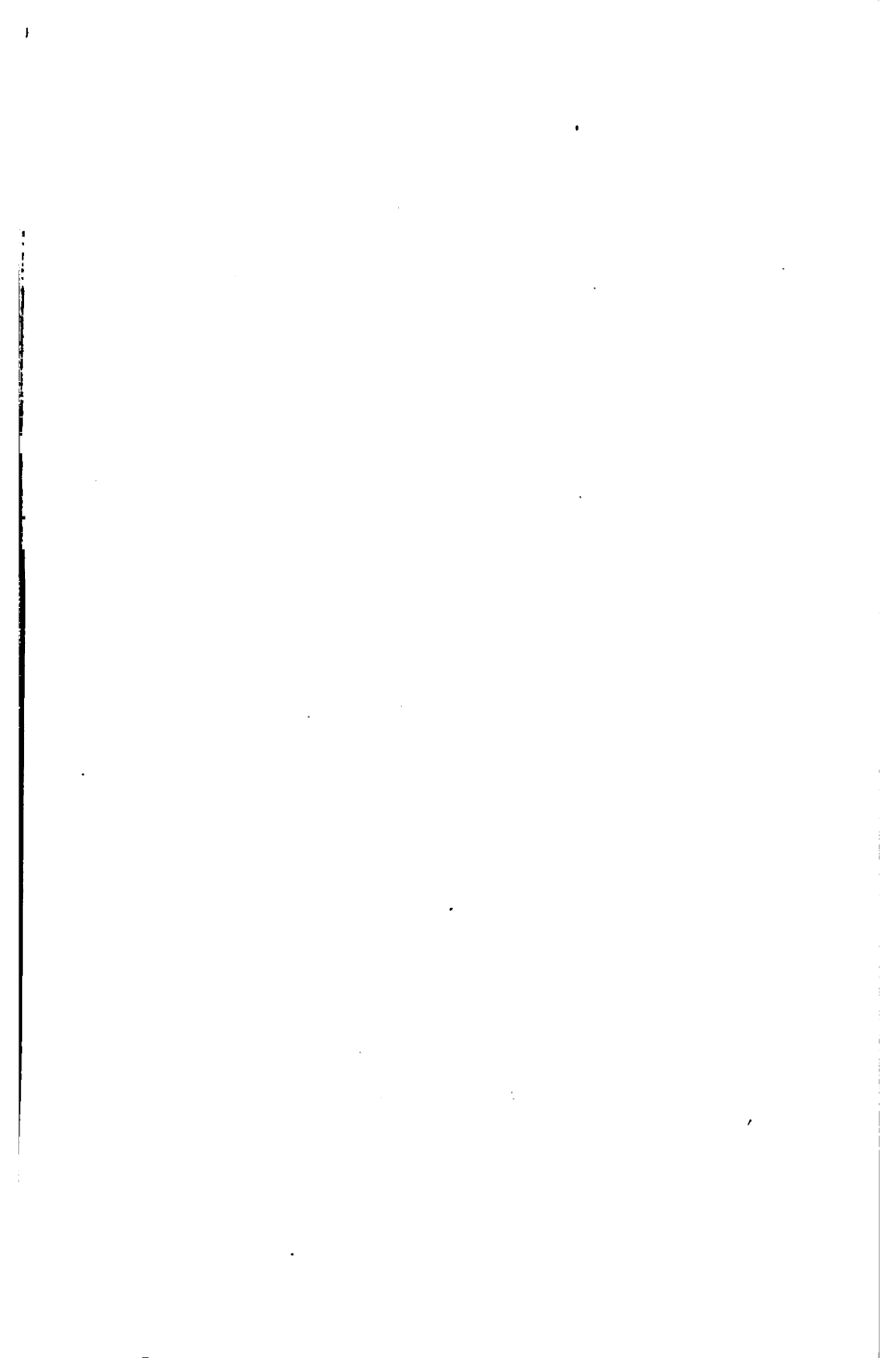



Thus far we have shown only one way of ascertaining the presence of X rays, namely, by their effect upon a sensitized plate. There is another and quicker way, however, which arises by reason of the fact that certain chemical salts possess the peculiar property of fluorescing when brought within the influence of the X rays. This fluorescence is not brilliant, but merely presents to the vision a moderate glow when the eyes are shielded from other light. It is not an easy matter to find an apt comparison with something familiar to every one, but perhaps this fluorescence is more nearly comparable to a ground-glass window pane at night, having behind it, at some little distance away, an artificial light of moderate candle power.

The idea of the X rays, which are themselves invisible, having the property of causing this fluorescence is somewhat of an abstruse conception for the layman, but probably a further simple comparison will tend to an easily comprehended and reasonable view of this.

It is well known that a diamond is a crystal and that in a perfectly dark room it will not show any light nor the beautiful colors for which it is esteemed. Exposed to rays of light, however, it at once becomes a sparkling gem. The chemical

salts which exhibit fluorescence in the X rays are all crystalline, but so far as their fluorescent property is concerned, they may be said to be always in the dark until they are brought into the presence of the X rays, when they at once light up, as the diamond does in light rays, although not with the same brilliancy or color effects.

It must be remembered that this comparison is not put forth as an explanation of the phenomena in question, but, as stated above, merely to assist the reader in forming some sort of an idea which may lead to a fair appreciation of fluorescence as observed in the Fluoroscope.

This peculiar property of these crystalline chemical salts has been availed of for the purpose of practical and instantaneous observations by means of a device called the Fluoroscope, which will be described in detail in a later chapter.

This fluorescent property was known three years ago and a screen covered with the crystals was used by Lenard in his investigations. Roentgen also made use of a fluorescent screen about a year ago. Similar screens were also used by Professor Elihu Thomson in the United States very early in the present year, very soon after the announcement of Roentgen's discovery. The

knowledge of the fluorescent screen became general some months ago, and subsequently Mr. Edison put it in the convenient form, now known as the Fluoroscope.

It will be sufficient to note at this point that opaque objects placed between the Crookes tube and the fluorescent crystals will prevent the X rays from striking that part of the crystals covered by such objects and, consequently, the crystals will not exhibit fluorescence at that spot. For instance, if a fluorescent screen be brought within the influence of the X rays and a hand be placed between the source of rays and the screen, the X rays pass right through the flesh, blood, veins, and muscles but do not penetrate the bones. Inasmuch as the crystals reached by the X rays become fluorescent, the screen glows except in the places not affected by the rays, and we therefore see in dark shadowy outlines the shape of the bones in the hand as they are at that present moment. When the generation of the X rays is stopped, or the fluorescent screen removed from the sphere of their influence, the fluorescence of the crystals ceases, not to appear again until once more exposed to the rays.

We believe that the reader will now have

gathered a general idea of the phenomena involved in Professor Roentgen's wonderful discovery, and we shall now proceed to describe more in detail the various items of apparatus used to produce the effects above noted and endeavor to give some hints as to its manipulation.

## CHAPTER II.

## THE EXCITING APPARATUS.

THE electric current necessary to produce the proper excitation in a Crookes vacuum tube should be possessed of two important qualifications. First, it should be of very high potential, and, second, it should preferably be an alternating, interrupted or intermittent current.

If we were to attach a Crookes tube direct to two of the conductors forming part of an electric lighting circuit no effect would be perceptible. We might take away these conductors and connect to them ten or twenty incandescent lamps of from 16 to 100 candle power each, and the current flowing in the wires would light up all these lamps to full candle power, although it would not excite one Crookes tube which would require under proper conditions less than one five-hundredth of the actual electrical energy needed to illuminate the lamps.

There are two reasons for this. First, the

current (let us say, continuous, or direct, at 110 volts) did not fulfil the qualifications referred to in the first paragraph; and second, that in the incandescent lamps the current has continuous paths of comparatively low resistance in which to travel, while in the Crookes tube the path in which the current may pass is exceedingly meagre, consisting merely of the molecules of air that are left in the tube after exhausting it to a degree where it contains only about one-millionth of an atmosphere. In this latter case it might be imagined that the current on entering the tube by one conductor is obliged to make a path for itself by driving the molecules of air towards each other and a second conductor and thus using them as its path.

The ordinary electric lighting current employed for incandescent lamps is not sufficiently powerful in pressure to jump across an air space, even if very small, although sometimes by accident some conducting substance may come in the gap forming an air space separating two conductors, and thus help the current across. In such a case, however, a continuous *arc* would be formed which differs from a stream of sparks jumping from one conductor to another when these two are connected to an apparatus which

is producing currents of very high potential with extremely rapid interruptions.

Electric lighting circuits for incandescent lamps and ordinary power are usually of comparatively low pressure, or voltage, generally between 50 to 120 volts, and in some cases as high as 240 volts. In all these systems, however, the rate of flow, or amperes, of current is usually large on account of the nature of the effects to be produced. The voltage in any such system is kept constant and steady and regulated within a few points, but the strength in amperes of current will vary very considerably according to the requirements of the consumers.

The electric current necessary to properly excite a Crookes vacuum tube to the degree at which the X rays are produced is enormously high in voltage, as compared with that of an electric light circuit. Such a current may vary in pressure or potential from ten thousand to hundreds of thousands of volts. The current in amperes, of such a circuit will, however, be exceedingly low, being only a very small fraction of one ampere in all cases.

It will be seen, therefore, that the actual electrical energy required to produce the X rays is comparatively small; indeed, the actual amount

of energy needed to light up an ordinary 16 candle power lamp to incandescence will be sufficient, when employed with the proper apparatus, to cause excitation enough to produce abundant and powerful X rays.

The reader will naturally inquire how this can be. To this we answer that it is by a transformation of the electrical energy from one form of potential to another. This is done by means of certain kinds of apparatus which will presently be described. The construction of this apparatus is based upon certain electrical phenomena, the laws of which have been well defined and availed of for the perfecting of many useful inventions.

The best known form of apparatus and the one most generally used for transforming electrical energy of comparatively low voltage and high amperes into a current of very high voltage and low amperes is the Induction Coil ; frequently called the Ruhmkorff Coil. Before proceeding to describe this, we shall, for the better understanding of the reader, devote a chapter to a brief explanation of the phenomena to which it owes its existence. In this explanation will also be involved the philosophy of another type of exciting apparatus, known as the High Frequency



Transformer, now coming into general use in connection with X ray work. This device is also one of the class which, like the Ruhmkorff Coil, depends upon electrical induction for its usefulness.

A third and entirely distinct type of exciting apparatus embraces what are known as Static Machines, which, while they rely upon induction for the effects produced, do not require to be continuously connected with a source of electrical energy, such as a battery or an electric lighting circuit, but from an initial charge build up, produce and discharge electric current as long as they are kept in rotation. Such machines are generally known as Holtz Machines and Wimshurst Influence Machines.

All of these three classes of exciting apparatus will be taken up in their order, but we shall first glance at the theory of the phenomena of induction.

## CHAPTER III.

## INDUCTION.

IT is not only in connection with the apparatus for production of the X rays that the reader will find a study of induction profitable, but also in connection with other electrical phenomena. We can scarcely lay too much stress upon the importance of electromagnetic induction in the practical electrical apparatus in use at the present time. It lies at the very foundation of all electric light and power devices now in operation ; in fact, almost all working electrical apparatus depends upon inductive effects for successful operation.

It might naturally be supposed by those unacquainted with electrical science, that, when a current of electricity is sent through a wire or other conductor, the influence of such current is confined to the wire or conductor and to the apparatus with which such conductor may be connected. This, however, is not the fact. The

influence of the current extends also outside of and away from the conductor over which it is passing, affecting other conductors to a greater or less extent according to their distance and their relative positions.

When an electric current is passed through a conductor, a change ensues in its neighborhood. A force that was not previously present is at once manifested and continues to some extent as long as there is current passing through the conductor. Surrounding the conductor there is an action which may be compared with a series of elastic rings expanding or collapsing, with changes in the current. These are called lines of force and are sometimes referred to as the magnetic whirl or magnetic field. They are diagrammatically represented in the sketch Fig. 4.

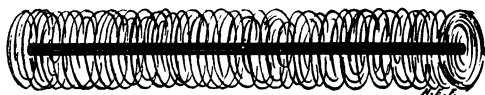

FIG. 4.

Magnetic lines are, of course, invisible to the eye and are merely ideal indications of direction of magnetic force or flux at any one time. In a stationary arrangement, with steady current,

they are stationary in space,—merely expanding or collapsing with changes in the current.

In a wire observed from one end, if the current is away from the observer, the lines are directed clock-wise (as the hands of a clock move), around the wire, the direction being always understood to be the direction along which north polarity tends. Thus, if a bar of iron be placed horizontally above a conductor leading away from the observer and the current goes *away* along the wire, the bar exhibits a north magnetic pole at its end toward the right and a south pole toward the left. If the bar be under the wire the polarity is the same as to direction *around* the wire, but now the north will be directed to the left and the south to the right. The reversal of the current will reverse all directions.

These lines of force may be considered to extend out almost indefinitely and to affect conductors at great distances, but their effect is only appreciable at very small intervals of space.

A simple illustration, somewhat analogous, may be taken to enable the reader to grasp the idea more clearly.

A stone dropped into a pond of still water will produce a series of rings, gradually widening but decreasing in power as they ripple away from the

central cause of disturbance and finally disappearing from the vision.

Some interesting experiments may be tried in illustration of this phenomena of the magnetic lines of force by passing through a piece of cardboard or stiff paper, a conductor from a dynamo, or from a powerful battery of primary or secondary cells and scattering upon the cardboard or paper a small quantity of fine iron filings. If the paper is gently tapped, say, with the end of a lead pencil, the filings will arrange themselves in circles about the wire, thus showing the direction of the lines of force (Fig. 5). An active conductor from a dynamo or sufficiently powerful battery will attract to itself iron filings if brought into contact with them.

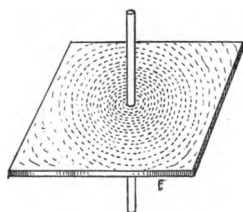

FIG. 5.

With a small compass or delicate horizontal galvanometer the presence and direction of the lines of force around an active conductor can be traced. To perform this experiment, it is well to have a piece of stiff cardboard or thin wood through which the conductor is run. The compass or galvanometer is then placed on this table in different positions around the circumference of

the wire, and the needle will be observed to

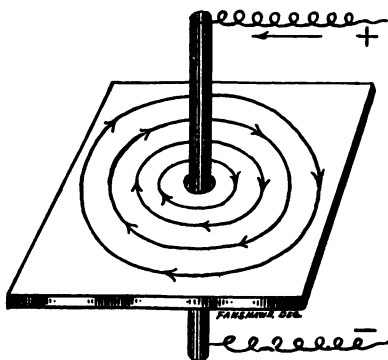

FIG. 6.

deflect. On reversing the polarity of the current the deflection will be in the opposite direction. Supposing the observer to be facing the upper end of the conductor (Fig. 6), the direction of the lines of force will be

from left to right when the current is flowing from the upper, or positive, end of the conductor, but of course, in the opposite direction on reversing the polarity of the current. Figure 6 is a diagram of the deflections obtained with the compass as seen by an observer facing the upper end of the conductor.

It should be noted in connection with this experiment that unless a powerful current is used, the influence of the earth's magnetism will probably affect the needle to a greater or less extent.

Let us now see what effect the magnetic lines of force above described have upon other conductors lying near to the active one, through

which a current is passing. We will place a separate wire, or conductor (calling it, for convenience, the secondary wire), near to and parallel with the active wire. The lines of force, which immediately spring out, cut across the secondary wire and cause a momentary current of electricity to be set up therein. This is what is known as Electromagnetic Current Induction, and the current set up in the secondary wire is an induced current.

This idea may be somewhat difficult to grasp in definite form, as we are dealing with manifestations of the energy of an invisible force, but probably a further reference to a water analogy may be of assistance by enabling the reader to establish in his mind a comparison with something visible and at the same time easily understood. It must be remembered, however, that this analogy is not exact, and is only used with the above idea in view. Let us place in a large vessel of water two corks at a distance of several inches apart. If one of the corks be suddenly pushed downwards, and released, a series of gradually extending rings will form in the water and, as they reach the other cork, it will be affected thereby and will also rise and fall. These rings may be likened to the lines of force present around a

conductor carrying current ; the cork which was pushed down representing the conductor, and the energy expended in pushing it may be considered as the equivalent of electric energy passing through the conductor. The other cork, of course, represents the secondary and is affected by the energy set up from the first one.

So long as the current flowing in the active wire remains steady, no further effect is perceptible in the secondary wire, but if the continuity, strength or alternations of the current, or the relative positions of the active and secondary wires, be varied, there will be induced currents set up in the secondary wire at each variation. The same effect will be produced each time the current is made and broken through the active, or primary wire, and the current induced in the secondary wire will flow in one direction on sending current through the primary, but will flow in the opposite direction when current is either broken or reversed.

Electro-magnetic Induction may, therefore, be described as an effect caused in a conductor by variation in a current passing through another and separate conductor lying parallel thereto.

Thus far, we have used for illustration the terms "active" and "secondary" wires, by



which there may have been conveyed to the reader's mind the idea of two comparatively short pieces of wire laid side by side. This idea serves as an aid for the more easy comprehension of the broad idea of an induced current, but in actual practice, great lengths of wire are used, the mechanical arrangement of which we shall briefly describe in explaining the induction coil.

It will be of interest to the reader, however, to explain a little further what the result is when considerable lengths of wire are used to obtain induced currents. It is not difficult to see from the foregoing that, if the primary or active wire be coiled in layers upon a bobbin and the secondary wire be coiled in layers upon and over the primary coil, there will be a great many lines of force thrown out when a current is sent through the primary.

These lines of force, cutting across the secondary wire, induce in all the convolutions thereof, a current, and this current which is induced in the secondary will also create lines of force, extending from the secondary. These inductive effects may be further increased by placing within the primary coil an iron core.

When a current is started through the primary

coil, it develops magnetic lines in the core and space around it, which in developing cut the turns of the coil, thereby checking the rise of current by a counter electromotive force. It therefore takes time to fully magnetize the core, owing to what is called its "self-induction." When we, on the other hand, attempt to cut off the current, the collapse of the magnetic lines results in their again cutting the coil turns and developing an electromotive force, which tends to prevent the stoppage of the current. This is another effect of self-induction, but prolongs the original current and may produce a spark or arc at the place where the circuit is opened.

It will be remembered that all these inductive effects are momentary and take place only at the instant of making or breaking the circuit, or on varying the strength or alternations of the current, or, on varying the relative positions of the coils. On breaking the current to the primary, all these lines of force contract, or fall back, upon the conductor from which they sprang, and in doing so, cut across the secondary again and induce current therein in the opposite direction, which is, of course, in the same direction as the primary current. It will be quite apparent, therefore, that the effect upon breaking the circuit is

more powerful than that upon making, owing to the suddenness of the magnetic changes in the core. If the magnetic change on *making* could be made as sudden as at the break, the inductive effects in the secondary would be equal in each case.

In an ordinary induction coil the pressure and volume of the current passed through the primary undergoes a change. It goes into the primary as a current of comparatively low pressure and high volume, but the induced current at the terminals of the secondary will be found to be of comparatively high pressure and small volume. The desired effects are obtained from an induction coil by winding for the secondary, a number of convolutions of fine wire of definite size proportionate to the size of wire and number of convolutions of the primary. For instance, we might say, that to obtain at the terminals of the secondary, ten times the pressure passed through the primary, there should be at least ten times the number of convolutions in the secondary that there are in the primary. If the pressure at the secondary terminals were thus raised ten times, the volume of current would be approximately one-tenth that which passed through the primary, but the total of the electri-

cal energy which originally passed into the primary would not be increased.

Induction coils are largely used, therefore, for the purpose of obtaining sparks, as sparks require high pressure, but only a small current passes at each spark. These sparks are of varying length, according to the amount and size of wire and the number of its convolutions. A coil three or four inches in length, containing from four to six ounces of wire, will produce sparks of one-eighth to one-fourth of an inch in length.

Ordinarily it is roughly calculated that one inch of spark could be produced for every pound of fine wire wound around on the secondary coil, but the most recent methods of winding tend to some modification of the rule.

The smaller and medium sized coils are largely used to obtain sparks for gas lighting, for firing fuses and for many other useful and experimental purposes. Small coils are also used by physicians for medical purposes, in which case handles are connected by flexible wires to the terminals of the secondary and the patient receives a rapid succession of shocks as the current is made and broken.

The inductive effects in an induction coil are usually produced by a rapid making and break-

ing of the current passing through the primary. This, in the simple form of coil, is effected by means of a vibrating armature which will be seen in Figure 7. It consists of an iron button placed on the end of a piece of spring steel set in a metallic post. When at rest, the spring touches, or makes contact, with another post to which is attached one connection from the battery which supplies current to the primary

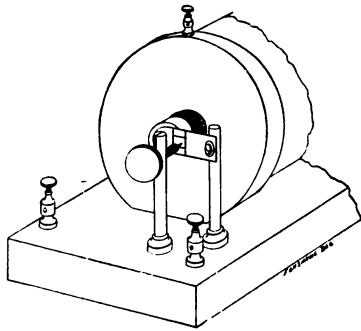

FIG. 7.

coil. To the first named post is attached one terminal of the primary coil. The other terminal of the primary coil is attached to the battery. When current is turned on, the electricity flows through the primary and immediately acts upon the iron core in such a way as to convert it into an electromagnet. The core, thus becoming magnetic, attracts the armature and draws it away from the post. This breaks the continuity of the circuit, and, therefore, shuts off the current from the primary.

As no current is now passing through the

primary, the iron core loses its magnetism, and cannot keep the armature attracted to it. The armature being mounted upon a spring, flies back and once more touches the post. This again completes the circuit, just as it did before, and the armature is again attracted to the magnetic core for an instant, which once more breaks the circuit, and so on, thus effecting a continuous vibration and consequent make and break of the circuit as long as the battery is connected. It is difficult from this explanation to conceive the extreme rapidity with which these successive makes and breaks take place, but the reader has had, or will probably have, an opportunity of observing it for himself.

## CHAPTER IV.

### INDUCTION COILS.

As the reader will have gathered from the preceding chapter some knowledge of the fundamental laws of induction and of their application in the form of apparatus therein described, let us now proceed to the consideration of some of the practical points which present themselves upon a study of the induction coil and its parts, and as a whole.

An ordinary induction coil consists of the following parts :

1. The core.
2. The primary coil.
3. The secondary coil.
4. The terminals of the secondary, or "spark-  
ing points."
5. The contact breaker.
6. The condenser.
7. A pole changer (optional, not necessary).

It is not within the proposed scope of this

work to give directions for constructing an induction coil, as there are many valuable books on this subject already published and readily accessible, but we will make mention of some of the more important points that may prove of practical value to the reader.

Taking up in their order the parts making up such a coil, we first reach the Core, which is simply a cylindrical-shaped bundle of soft iron wires each of small cross section. These wires are firmly bound together so as to form, in appearance at least, a solid piece. The core is sometimes soaked in shellac or paraffine to obtain good insulation, and sometimes it is given one or more outside wrappings of insulating tape for the same purpose. In large coils both these methods are sometimes employed.

Two things are very important in constructing the core, one being that the iron from which the wires are drawn is of the kind known as "soft" iron, and the other that the diameter of the wires should be quite small. Objectionable heating of the core may result, by reason of what is known as hysteresis, on account of the qualities possessed by some kinds of iron. The same objectionable effect would also occur, by reason of Foucault, or eddy, currents if a solid iron core



or wires of large diameter should be employed. The use of iron wires of small diameter is made to ensure a rapid demagnetization, as well as to avoid heating effects.

After the core is insulated, by wrapping, or by slipping over it an insulating tube, the primary coil is wound upon it. This coil is of coarse copper wire, well insulated, and consists usually of two layers, one wound over and on top of the other. Each layer is insulated from the other. Some makers wind the primary coil in more than two layers, but it is not a practice to be recommended, as the best effects cannot, generally speaking, be obtained in that way.

We come now to the most important part of an induction coil, namely, the secondary coil. While the size and quantity of wire used for making this, together with the manner in which it is distributed or wound will determine the size and quality of the spark produced, the question of perfection and thoroughness of insulation will present itself for perhaps the foremost consideration.

This feature requires the most thorough care and calculation, for the high potentials at which the sparking effects are produced may cause the sparks to pierce both the primary and secondary

coils and, by breaking down the insulation thereon, render the whole coil utterly useless for the purpose for which it was designed.

After the primary coil is wound it is usually covered with a thick tube made of many layers of paraffined paper, or with a tube consisting of hard rubber, micanite or some other insulating substance, entirely free from metallic particles. Upon this is commenced the winding of the secondary coil. The wire used for this coil is very small in cross section and usually has a cotton or silk covering. The winding should be done very carefully and each layer well insulated with paraffine, shellac or other compound. Besides this, a sheet of paraffined paper is usually laid between each layer.

The secondary of a large induction coil will contain many thousands of turns of this fine wire, and, of course, a large number of layers. There are wide differences of opinion in regard to the distribution of the turns of wire upon the secondary as well as the methods of winding and the degree of insulation. There is also a great difference in opinion among manufacturers as to the amount and size of the wire to be used on the secondary coil. The extent of this difference of opinion may be appreciated when it is stated that

an induction coil recently made to give a spark of 12 inches weighed over 400 pounds, while the writer has one in constant use (made by another manufacturer), which, while it will give heavy 14 inch sparks, weighs only about 75 pounds.

The ends of the wire forming the secondary coil are connected with two binding posts which

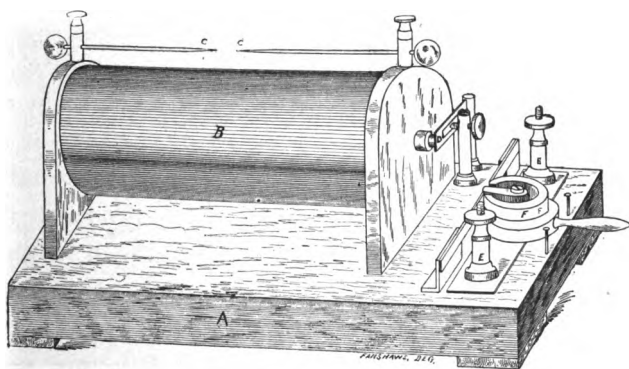

INDUCTION COIL.

A, Base; B, Coil; C, Discharge Terminals; D, Contact Breaker; E, Battery Connections; F, Pole Changer.

are usually made to contain two rods free to slide therein so that the length of the spark may be increased or diminished within the rated limits of the coil. These are known as the secondary, or discharge, terminals.

We now come to the contact breaker, which

is also an important part of the apparatus. The reader will recall the fact that an induced current in a conductor in which current is flowing occurs at the instant the circuit is made or broken, but not while current may be steadily flowing. It is apparent, then, that the more abrupt and complete the make and break (especially the latter), the more pronounced is the inductive effect obtained.

It is the aim of manufacturers, therefore, to make the contact breaker quick and certain in its action. On referring to Fig. 7, it will be seen that the ordinary circuit breaker consists of a flat spring carrying an iron armature. This spring is attached to a post and is normally so placed as to keep the armature away from the core of the induction coil, but is so arranged that it will make contact with another post that forms part of the battery circuit. The action of the circuit breaker has already been described at the end of the chapter preceding this one, so there will be no necessity of repeating it here.

The developments of experiments with the X rays have demonstrated that this form of contact breaker is not the one best adapted for obtaining results of the higher type, and the march of improvement has necessitated the adoption of

other forms, especially with large coils. We propose, however, to treat of these forms in another chapter.

The condenser of the ordinary form of induction coil is usually placed in the interior of a hollow wooden base upon which the coil is mounted. The form of condenser most generally supplied consists of a number of sheets of tin-foil separated from each other by one or more thicknesses of paper, which may or may not be paraffined, but preferably the latter. Each sheet of tin-foil has a "lug" or end projecting out beyond the paper, such lugs being placed alternately at the ends. These lugs are all connected together at each end of the condenser, thus bringing each set of sheets to one conductor. These are then connected so as to be in shunt with the contact breaker.

The office of the condenser is to accumulate temporarily a charge of electricity upon the rupture of the primary circuit, and when stored to its full capacity to discharge a current suddenly and quickly, thus adding to the high potential output of the coil. This is an exceedingly important adjunct of an induction coil and will be a little more fully discussed under the separate chapters on Condensers.

The last item under our enumeration is the Pole Changer. This is not so much an item of importance as it is of convenience, it being intended to enable the operator to change the polarity of the primary current going into the coil and thus reverse the polarity of the high potential current that is discharged at the secondary terminals. The same result can be attained by reversing the connections of the two conductors carrying the primary current, but not so speedily or conveniently as with a properly arranged pole changer. In experiments with the X rays it is sometimes desirable to change the polarity of the current for the purpose of making certain experimental observations, although in practical work it is generally unnecessary after the apparatus has once been set up and started, as will appear later.

It may assist the reader to more easily comprehend the construction of such a coil as has been described by referring to the sectional drawing, Fig. 9, in which the various parts are shown.

Having glanced briefly at the construction and operation of the ordinary form of induction coil, let us now see what developments in the perfection and modification of such coils have been made to render them more adaptable for use in X ray

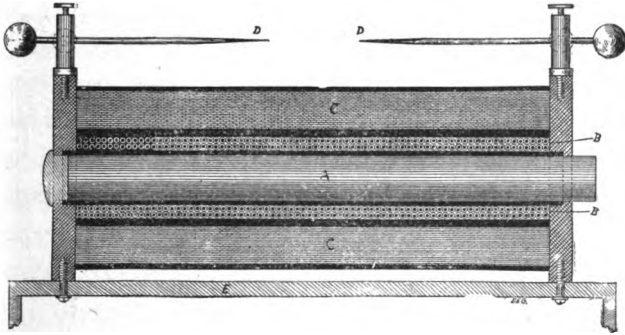

FIG. 9.

A, Core; B.B, Primary Coil; C, Secondary Coil; DD. Discharge Terminals; E, Base.

work. In a subsequent chapter we shall present some suggestions as to the sizes and capacities of induction coils required by experimenters and others for various degrees of practical results expected to be attained in this interesting field.

The lines upon which the most recent improvements in induction coils have been made are as follows :

- (a) The amount and size of wire upon the secondary coil, and the method of winding it ;
- (b) The insulation of the primary and secondary coils ;
- (c) The contact breaker ; and
- (d) The condenser.

These items are the important ones in induction coils for X ray work for the following reasons :

(1) Currents of very potential and a certain quality of spark are essential to obtain the best results in the generation of the X rays.

(2) Induction coils are usually worked for comparatively long periods of time and at high pressures for this class of experiments, thus requiring exceptionally high insulation.

(3) A high number of breaks, with certainty, regularity, and freedom from injurious heating, is desirable.

(4) Perfection in condensers, with relation to their capacity, insulation and quick discharge, has been found to be essential.

Taking up these points in order, we find that there are quite a variety of opinions as to the size and amount of wire to be used for the secondary coil as well as the methods of winding it. A long coil wound with very small wire will give a long, thin spark and demagnetizes slowly, while a shorter and thicker coil wound with heavier wire will give a shorter but a "fat" spark, and will act more quickly than the longer one. Combinations have been made of these methods, by which very desirable results have been obtained.

Many coil makers wind the secondary in a



greater or less number of sections, especially in making large coils for sparks of 6 inches in length and upwards. In most coils, the secondary is wound in equal turns from end to end, while in others the greatest number of turns are in the middle of the spool, gradually decreasing towards each end. There are other methods of winding,—in fact, the subject is one of such great detail that it would be out of the question to do more than make a general reference to it in this book, leaving the reader to consult one or more of the many valuable text-books on coils and their construction, should he desire to build a coil for himself.

As we propose to treat in this chapter only of the practical value and uses of induction coils for X ray experiments, it becomes important to make some further mention of the question of insulation,—the vital part of the apparatus. Up to the time of Prof. Roentgen's discovery, induction coils were not subjected, generally speaking, to the severe and constant use that has been demanded of them in investigations of the X ray phenomena.

It was not an unusual thing, however, prior to that time, to puncture the insulation of a coil during the course of experimental work, but this

has happened much more frequently during the new class of experiments, especially in the case of coils made some time ago.

The aim of the careful manufacturer at this day, in making induction coils for X ray work, is to insure the utmost degree of perfection in the insulation of the primary and secondary coils as well as to provide such a winding as will insure a continuous stream of fat, heavy sparks.

There is probably no more efficacious way of producing the most perfect insulation of the primary and secondary coils than by entirely immersing them in oil. In this way it is practically impossible to break down the coil, as the oil affords the greatest possible degree of protection from sparking both internal and external.

Where a coil is insulated in this way, it is usually placed in a box which is intended to be filled with oil. The primary and secondary terminals are, of course, led out to suitable binding posts on the exterior of the box, and the circuit breaker is introduced in the outside circuit. The writer has had such a coil in constant use many hours per day for several months in connection with X ray experiments and investigations, without having had the slightest trouble by reason of the insulation.

The coil box may be provided with means to allow of the oil being drawn off at any time should it be necessary or desirable. The box should also be provided with a cover which can be tightly closed to keep the oil from collecting dust or particles of metal or other substances that might gradually work into the layers of wire and cause trouble. A coil immersed in oil as described should be capable, with this protection, of practically continuous work for an indefinite period of time.

## CHAPTER V.

## CONTACT BREAKERS.

THE Contact Breaker is a device which is used only in connection with apparatus of the Ruhmkorff Coil type. The ordinary form of contact breaker, consisting of a vibrating spring with armature attached has already been described in Chapter III. This is the form that has been most generally used for many years on induction coils, especially in the lower range of sizes, such as those giving sparks of six inches and less. The developments, however, which have been made, in connection with X ray experiments, have necessitated other forms which are much more desirable for this class of work.

For the other purposes for which induction coils were most frequently used, it was not often that a large amount of current was applied to the primary coil, and therefore, the spark which resulted upon breaking the circuit was not especially destructive. In working on the X ray

experiments it is found desirable and necessary to use a comparatively large amount of current. The sudden interruption of this current by means of a vibrating armature would result in a destructive spark at each break of the circuit. This would have two effects, namely, to burn away the metal points at which contact is made, and to heat up the spring and gradually change its temper. Besides, the effects obtained in the Crookes tube would be uncertain and unsatisfactory in using a large coil with a contact breaker of this kind.

There is also another undesirable feature of vibrating circuit breakers where the amount of current used is comparatively large, and that is, the irregularity of the vibrations and also their limited number. For the production of the X rays and obtaining the best results therefrom it is very desirable that the circuit to the primary coil shall be made and broken very rapidly, regularly and with certainty.

To obtain these results, it is now usual to employ a mechanical circuit breaker, operated by a small motor. These mechanical circuit breakers are made in various designs according to the views of different experimenters.

The important features of a contact breaker of this kind are :

(1) That that part which operates for the making of the circuit shall be sufficiently long to allow the current to energize the primary coil ;

(2) That the break shall be sufficiently long and sharp to insure the quickest possible breaking of the circuit without drawing an arc ;

(3) That the number of revolutions of the contact breaker shall be steady ; and

(4) That the brushes shall bear evenly upon the surface.

A contact breaker of this kind need not be made so that both polarities of the current shall be broken. One of the rings upon which the brushes rest may be continuous, while the other may be divided into segments according to the number of makes and breaks desirable.

A good form of contact breaker can be made by mounting two rings upon a circular slate base, one of the rings having several sections cut out for the purpose of obtaining the necessary breaks in the continuity of the current. These rings may be fastened to the slate base by means of screws and the whole mounted either upon the motor shaft or upon a separate shaft fitted into bearings and arranged with a pulley to be driven

by a motor. A contact breaker of this latter class is illustrated in Fig. 10.

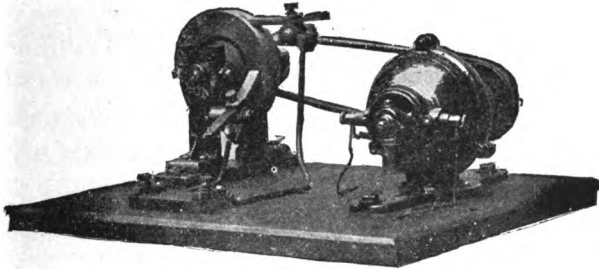

FIG. 10.

Two brush-holders are mounted so that brushes may be inserted and so arranged as to bear evenly upon the surface of these two rings. If the slate is cut so as to be flush with the surface of the broken ring between the sections a smoother running apparatus will be the result than if the face of the slate is below the surfaces of the separate sections.

It will be found that even in contact breakers of this kind it is impossible to avoid the spark which results on breaking the current. It is highly desirable to eliminate this spark if practical means are at hand for doing it. The general way of accomplishing this result is by means of an air-blast directed against the under surface of the brush upon which contact is broken.

While it is not absolutely essential to blow out the spark, the results of doing so are of great

benefit, as a greater abundance and steadier stream of X rays will be obtained thereby. An air blast is not always possible to the experimenter, however, and probably the next best thing is to put the circuit breaker into a small tank of water and operate it in that way, thus extinguishing the spark as soon as it is formed. Circuit breakers of this kind are to be had in the market.

It must be borne in mind that the circuit breaker of the induction coil is also an exceedingly important part of the exciting apparatus as the results depend largely upon this particular item. No results can be obtained from the induction coil without making and breaking the circuit carrying the current to the primary coil, as the reader has already learned.

The success of the experimenter in producing the X rays steadily and satisfactorily depends quite largely upon the perfection of the contact breaker. If it acts smoothly and regularly, and with certainty of break, the rays produced will be correspondingly abundant and steady, provided, of course, that the source of current is of the requisite strength and the vacuum tube well and properly made.

While it would, of course, be desirable to operate small coils, giving, say, from one inch to



three inch sparks, on mechanical contact breakers, there is not the necessity of such perfection in the break as there is in operating coils giving sparks of four inches and upwards.

In the smaller class of coils, for instance, those giving up to, let us say, three-inch sparks, it is not to be expected that such an advanced class of work can be accomplished with the X rays as may be done with coils of larger capacity. This of course is self-apparent, as the higher potential of the discharge of the large coils is much more powerful than those of smaller coils.

It is quite possible for the experimenter to get good X ray results from a three or four inch coil using the regular form of vibrating contact breaker with a good example of vacuum tube, but even with so small a coil the results will probably be better if operated with mechanical contact breaker. Such a coil can be so used, if desired, by short circuiting the vibrating contact breaker and connecting a mechanical one to the apparatus. The writer has operated quite successfully an ordinary form of coil giving a spark of not more than  $1\frac{1}{4}$  inches in this way.

## CHAPTER VI.

## THE CONDENSER.

THE name "Condenser," as applied to this piece of electrical apparatus, does not always convey to the lay mind a thoroughly appreciative comprehension of the principles of its philosophy and action. The word "condenser" is most frequently used and readily understood in connection with apparatus for condensing steam, which is something visible and tangible, but, when dealing with electricity which can neither be seen or handled, the idea of a condenser is less easily grasped by the general reader. The term "accumulator" is alternatively used as a name for a condenser of electricity, and to a certain extent is correct, although it should not be confounded with the same name as applied to secondary, or storage, batteries.

Perhaps a simple analogy will assist the reader to comprehend more readily the theory of the condenser. This analogy is not by any

means a perfect one, but will probably serve as a basis for comparison.

Suppose we should take a plate of glass and hold it over the steam issuing from the spout of a tea-kettle containing boiling water. That side of the glass touched by the steam would immediately become clouded by reason of the steam condensing upon it. After a short time this cloudiness would assume the form of innumerable little globules of water and, still holding the glass over the steam, the condensation would gradually accumulate and the globules of water would increase in size until by their increased weight they would drop off (or, we might say, discharge), from all parts of the plate.

Now, while electricity is intangible and has neither body nor weight, we shall find this idea of water condensation to possess a sort of rough-and-ready basis of comparison in the following brief explanation of the condenser of electricity, except that it should be remembered that the discharges of the condenser are almost inconceivably rapid.

These condensers are usually made of sheets of tinfoil, separated from each other by an insulator or dielectric. The dielectrics usually employed are either glass, mica or paper, and

when the latter is the one chosen it is frequently coated with paraffine. The action of the condenser is due to the inductive effect of the electrical charge on one sheet of tinfoil (conductor) upon another across the dielectric interposed between them, as we shall explain a little more fully.

Let us suppose that we have two sheets of tinfoil A and B (Fig. 11), and between them a dielectric C, which for the purpose of the illustration, may be a pane of glass.

Now if the conductor B be connected with the positive pole of a source of electric energy and the conductor A with the earth, the conductor B will become positively electrified and will act by induction across the glass and upon the conductor A and send a positive current to the earth, leaving a negative charge

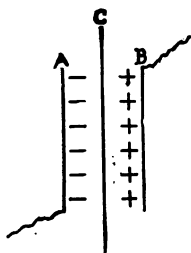

FIG. 11.

upon that face of A that is nearest to B. As two opposite polarities attract each other, this negative charge of A will attract a greater positive charge upon the nearest face of B, and the nearer these conductors are brought together, the greater the attraction for each other, which results in a greater accumulation or condensa-

tion of electricity upon their respective surfaces. It will be seen, therefore, that the capacity for condensation of such a conductor is greatly increased as it is brought nearer to another conductor oppositely electrified.

Condensers may be made in many ways, but for all ordinary purposes, such as for use with Ruhmkorff coils, they are made up of sheets of tin-foil (conductor), and paraffined paper, (dielectric), laid alternately, the tin-foil being much smaller than the paper to avoid leakage around the edges. Each sheet of tin-foil has a projecting lug and these are placed so as to project at one end alternately, as seen in the sketch, Fig.

12. When all the sheets are laid, finishing with a dielectric top and bottom, the whole is bound



FIG. 12.

together tightly to further increase the capacity. Ordinarily the entire block is soaked in melted paraffine. The projecting lugs at each end are connected together so as to form two solid terminals.

The effect of this arrangement of the conductors and dielectric is to make practically two large conductors of an area equal to the aggre-

gated area of the sheets of tinfoil used in making the condenser. When thus made, a condenser will have a very considerable capacity and may be charged with a greater amount of energy than if its capacity were less, either by reason of a smaller area of conductors or by increasing the distance between each of the conductors.

The above arrangement is intended for condensers of comparatively low potentials. If a condenser for a very high potential is desired, the sheets of tinfoil should be smaller in relation to the dielectric, and they are laid alternately as before, but without lugs or other connections between the respective conductors.



FIG. 13.  
of its length.

Connections are made only with the upper and lower conductors. The danger of leakage in a condenser so constructed is greater than in the other form.

The best known and original form of condenser is the Leyden jar (Fig. 13), so called from the town of Leyden, where it was invented. It consists of a wide-necked bottle coated with tinfoil inside and out about two-thirds in a dry, well-shellacked cork

fitting into the neck is inserted a brass rod, the lower end of which carries a small chain making contact with the tinfoil in the inside of the jar. The upper end of the rod is surmounted by a brass ball. This form of condenser may be charged from an induction coil by connecting the ball and outside coating in series with one of the secondary terminals of the coil. By applying one terminal of a discharger with insulated handles (Fig. 14) to the outside coating and approaching the other terminal to the ball the accumulated charge will be discharged with a detonating spark.

There are a very large number of interesting experiments that may be performed with this and other forms of condenser, but as we are only considering this form

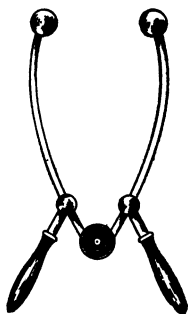

FIG. 14.

of apparatus from the standpoint of its use in connection with exciting apparatus for the production of the X rays, we shall not stop to enlarge upon other experiments, especially as they are given in detail in most of the standard text books on physics.

It is merely intended in this chapter to convey to the reader a general idea of the theory and

use of the condenser, and to give a brief description of the method of its construction. There remains, therefore, only a brief mention of its sphere of usefulness in connection with the apparatus under consideration.

As used with apparatus of the induction coil type, the condenser is connected in shunt with the primary coil.

Now, when an electric current is sent through the primary coil from the batteries or other source of energy, we have seen that a current is induced in all the turns of the secondary coil. Besides this, the primary, when broken by the contact breaker, also tends to induce current in itself. This is known as a self-induction discharge. This self-induction discharge would spark across the circuit breaker if it were not for the condenser, and the break of the current would be less sudden. The extra current is accumulated by the condenser at the break of the circuit and is immediately discharged back into the primary with lightning-like rapidity, with the result of very greatly increasing the potential of the current induced in the secondary coil.

It should be understood that the accumulation of charge in the condenser is fully what the term implies. It is an accumulation of charge and



potential while the primary coil is discharging, and if the original current had a potential of eight volts, the accumulation in the condenser might be ten or twelve times as great. Thus it will be seen that the effect of the whole of this accumulation being rapidly and suddenly discharged into the primary coil is to produce very powerful inductive effects.

To recapitulate, we may say briefly that in connection with an induction coil the condenser has two objects, one being to cut down the sparking at the circuit breaker and the other, by its sudden and total discharge into the primary, to greatly increase the strength of the induced current in the secondary coil.

Ordinarily, condensers furnished with induction coils have a stated capacity which is unchangeable, but others are specially made with reference to the use of either fractional parts or the whole of their capacity. These are useful to the investigator of X ray phenomena who desires to procure refinements of experimentation, but they are not absolutely necessary. Further reference will be made to the subject of adjustable condensers in the chapter on Manipulation.

## CHAPTER VII.

## HIGH FREQUENCY APPARATUS.

IN a preceding chapter we have learned that the induction coil is an apparatus which, by reason of inductive effects, will transform a current of low potential and high amperes into a current of exceedingly high potential and low amperes. The primary current in this case may be a direct or continuous one, the inductive effects taking place upon the making and breaking of the circuit by mechanical means.

A reverse transformation of the current could be obtained with the same coil if a current of very high potential and low amperes were led into the terminals of the *secondary*. In this case an interrupted current of low potential and comparatively high amperes could be obtained at the *primary* terminals.

This kind of transformation is practically what is done in systems of electric lighting by means of *alternating currents*. In such a system an

electric current of high potential is generated at a central station and sent through conductors to the points where it is used. At these points coils, or, as they are termed, "transformers" are placed. The high potential current is sent into the secondary of a transformer and from the primary terminals a current of low potential with large ampere capacity is taken for electric lighting or power.

The transformation is effected by induction, as in the Ruhmkorff coil, but in dealing with alternating currents the inductive effects are not obtained by a mechanical interruption or breaking of the circuit, but by continuous changes of direction, or alternations, of the current.

It will be remembered that in the chapter on Induction it is stated that as long as the primary current is steady and continuous no inductive effects are noticeable, but if the continuity, strength or alternations of such current be varied a current will be induced in the surrounding coils. Now, the current from a battery connected with the primary of an induction coil (Ruhmkorff) is continuous and flows in one direction, and therefore its continuity or strength must be varied by mechanical means, but the alternating current, as its name indicates, is not continuous,

but travels first in one direction and then in the other.

Thus it will be seen that the alternating current possesses from its very nature the necessary quality to cause (without mechanical interruption), inductive effects in apparatus suitably constructed with reference to its employment. It may be here noted that the mechanical construction of transformers differs somewhat from that of the ordinary form of induction coil. We shall not attempt, however, to enter into the details of such construction, as it would require too much space and is not within the scope of this book.

We shall confine ourselves, therefore, to such points relating to alternating currents as will enable the reader to comprehend the action of High Frequency Apparatus used for production of the X rays.

As alternating currents are produced in the first place by mechanical means, that is to say, by dynamo-electric machines actuated by steam engines or other motive power, it necessarily follows that the alternations of the current must have some degree of regularity. Diagrammatically, an alternating current is represented as shown in Fig. 15. The line A B is the zero line.

The current starts at the line in one direction and rises to its maximum potential, dying down again to zero, then starting again in the opposite direction and dying down once more to zero, and so on.

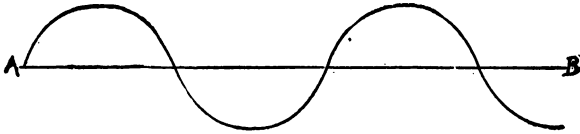

FIG. 15.

Each of the waves represents one alternation either in a positive or negative direction, and two of these waves represent a complete double reversal, or *cycle*.

The time occupied by two alternations, or a complete cycle, is called a period, and the number of periods per second is known as the *frequency*. In the greater number of alternating current dynamos in use at this day the frequency varies between 60 and 130 cycles per second, or from 7200 to 15,600 alternations per minute. It will be seen, therefore, that comparing the inductive effects in an induction coil actuated by a continuous current broken by mechanical means and similar effects produced in a coil through which an alternating current is flowing, the results in the former cannot, by reason of the

natural limits of mechanical circuit breakers, be as rapid, continuous and powerful as in the latter. When we add to the alternating coil, or transformer, one or more condensers, it will readily be appreciated that the alternating current transformer, or High Frequency type of exciting apparatus, is indeed powerful in producing discharges of high potential, and with regularity and very great frequency.

Briefly described, a set of high frequency apparatus for use with vacuum tubes for the generation of the X rays consists of two coils, or transformers, with one or more condensers, two discharge terminals and a spark gap. The latter also consists of two terminals or metallic rods each terminated by a metal ball. As commercially manufactured at this date the two transformers and a condenser are usually placed in a box which may be filled with oil for high insulating purposes, and the discharge terminals and spark gap are located on the exterior of the box. Such an arrangement, together with a small motor air blast (the use of which will be presently explained) is shown in Fig. 16.

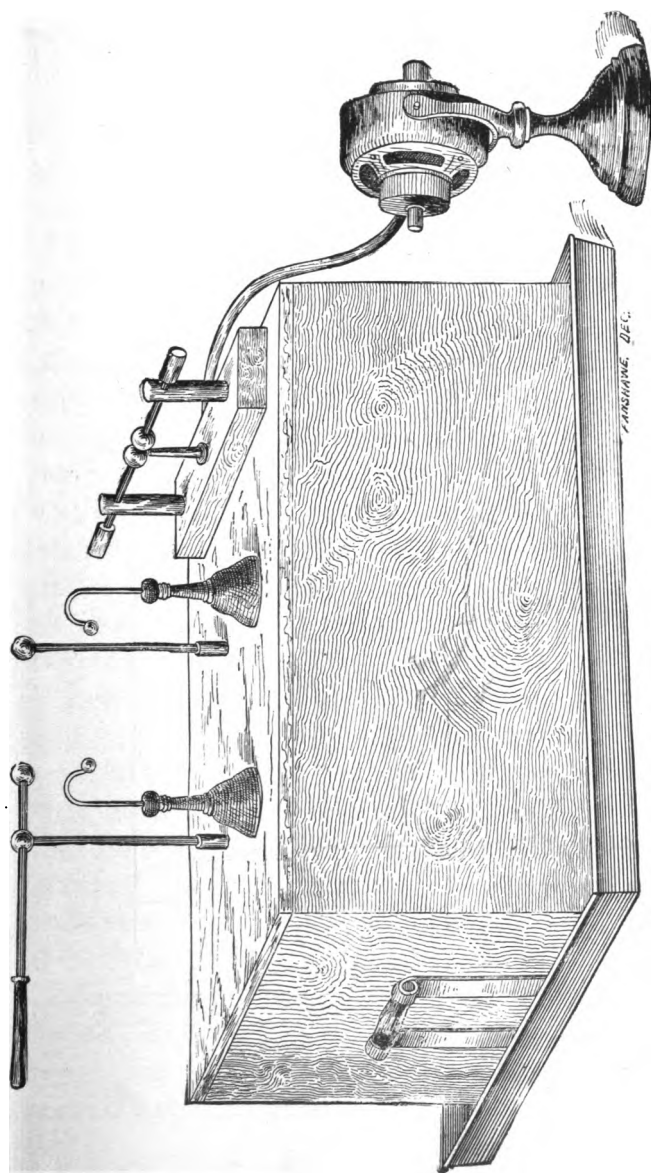

FIG. 16. THOMSON ROENTGEN RAY TRANSFORMER, OR HIGH FREQUENCY APPARATUS (WITH AIR BLAST).

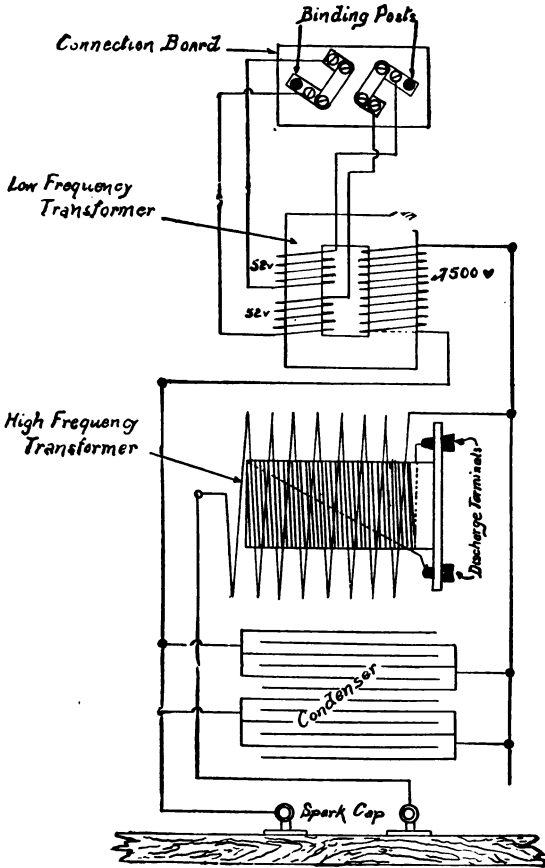

FIG. 17.



A diagram of the arrangement and connections of these transformers, condenser, discharge terminals and spark gap is given in Fig. 17. On referring to this diagram it will be seen that the primary of the low frequency transformer, or coil, is connected directly to mains from an alternating current circuit, and that the terminal wires of the secondary of this transformer are extended and are wound so as to form the primary coil of the high frequency transformer, while the condenser is in shunt with the last named primary and the spark gap forms a break in its continuity. The discharge terminals are the terminals of the secondary of the high frequency transformer.

Let us now see what the action of this set of apparatus is, bearing in mind that each of the transformers is really an induction coil, the name "transformer" being usually given when such a coil is designed for work upon an alternating current.

When this set of apparatus is connected with the circuit and current turned on, it passes through the primary of the low frequency transformer, and, by reason of the alternations, currents are induced in the secondary. As the secondary coil consists of a great many turns of

comparatively fine wire, the current induced therein is of vastly higher potential than the inducing current. Let us assume that the primary, or inducing, current has a pressure of 52 volts, we may find that the induced current in the secondary has a potential equal to 7500 volts.

As we have observed from the diagram, Fig. 17, the secondary of this low frequency transformer becomes the primary of the high frequency transformer. We might for a moment consider the latter as an independent induction coil and the low frequency transformer as a source of current (similar to a battery) from which the primary is to be excited. Indeed, it is such in reality. It will be apparent, therefore, that with an energizing current such as will flow through the primary of the high frequency transformer (say 7500 volts), the inductive effects in its secondary, wound with still finer wire, will be to produce an induced current of exceedingly high potential at the secondary terminals.

The sole purpose of the low frequency transformer (giving, say, 7500 volts at its secondary) is to charge the condenser, its secondary terminals being connected thereto. When the condenser is so charged as to leap the spark gap and pass

through the few turns of primary of the high frequency transformer, such discharge is very rapid, oscillating at very high frequency. The potential of such discharge does not rise above the 7500 volts, in fact it is generally less than that.

If the secondary of the high frequency transformer has twenty times as many turns as its primary, the potential is twenty times greater, or 150,000 volts, less a considerable loss due chiefly to the distance of the coils from each other. A five-inch spark at the secondary terminals of the high frequency transformer would represent a potential of 50,000 to 75,000 volts.

It must be remembered that the figures above given as a ratio of potential are not exact, but are intended only as an approximation and for purposes of comparison and elucidation.

The reader will now naturally inquire why one transformer should be designated as of low frequency and the other of high frequency.

As we have stated above, the frequency of an alternating current has reference to the number of complete cycles or double reversals, per second. The inductive effects in the low frequency transformer occur only on each alternation of the original current, once as the wave begins, and

again when it dies down. Thus, if such current had a frequency of 65 cycles per second, there would be set up in the low frequency transformer 260 inductive effects in the same period of time. If there were no condenser in the circuit of the low frequency transformer (which, it will be remembered, is the primary of the high frequency transformer), the same number of effects would take place in the latter; but the discharges of the condenser are even *more* frequent than the original alternations, thus multiplying the inductive effects in number and making this latter transformer one of correspondingly high frequency.

The function of the spark gap is to force the condenser to charge to a high potential *before* discharging through the primary coil of the high frequency transformer. As we have stated above, this discharge is oscillatory and occurs with very high frequency. Low potential *arcing* over the spark gap must, however, be prevented or the condenser would not charge. This is secured by an air blast on the gap or by special construction and proportional arrangement of parts without the air blast.

If the spark can be extinguished as quickly as it is formed, the break or rupture of the circuit

will be much more positive and sharp than by allowing the spark to weaken and die out naturally. Various methods have been devised, therefore, to extinguish the spark, chief among them being the electro-magnetic blow-out and the air-blast. The latter is the more simple method of the two, being usually accomplished by means of a small motor with fan attachment to which is affixed a pipe terminating in a small nozzle so placed that the jet of air will be directed between the two terminals of the spark gap.

Although, by means of the air-blast, the spark is extinguished in an exceedingly small fraction of a second after it is formed, the extinguishment cannot be perceived by the eye when the apparatus is in operation on account of their extreme rapidity of succession. When we consider that these sparks may jump across this small gap with a frequency of perhaps 500 or 600 per second, it will be evident that it would be quite out of the question to perceive the forming and extinguishing of an individual spark. In action, therefore, there appears to be a torrent of sparks constantly jumping across this small gap.

To close our description of this apparatus some mention must be made of the discharge terminals from the secondary of the frequency transformer.

It is here that the cumulative and entire inductive effect is obtained. Between these terminals, tremendously powerful sparks and discharges are obtained, and it is with these terminals that the Crookes tube is to be connected when the apparatus is used in X ray investigations. These terminals are usually in the form of brass standards carrying discharge rods, each terminated at one end by metal spheres and at the other end by rubber insulating handles.

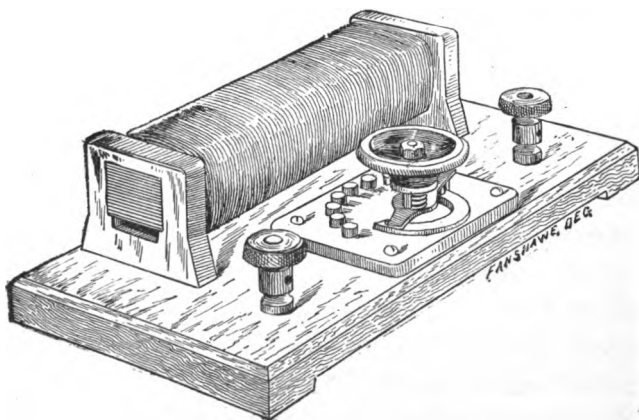

REGULATOR FOR THOMSON HIGH FREQUENCY SET.

Some forms of this apparatus as commercially supplied have a small regulating coil by means of which the amount of current admitted to the low frequency transformer may be governed.

This is useful in adjusting the apparatus so that more or less powerful effects may be obtained according to the requirements or peculiarities of the Crookes tubes in use or the necessities of the particular case in hand.

Although the description of this particular type of apparatus may make it appear to be somewhat intricate and involved, its operation is reasonably simple with a small amount of experience. The accessories are few, and it has one good feature to recommend it where alternating current is available and that is, it may usually be connected direct to the circuit and there are no batteries to look after. Indeed, this type of apparatus could not be operated by batteries except through the medium of costly and unusual apparatus.

The High Frequency apparatus is very powerful in generating the X rays when used in conjunction with a good vacuum tube. The type of tube that seems to be best suited for these discharges is a double focus tube, for the reason that in this form there are three electrodes, two of which can be connected to the two terminals of the apparatus, and the bombardment of the cathodic stream takes place upon the third electrode, thus producing the X rays. It should be borne in

mind that as the high frequency set depends upon an alternating current for excitation, each of the two terminals is alternately positive and negative, but the high frequency with which these changes occur results in almost a constant cathodic stream bombarded upon both sides of the third electrode.

There is one thing that should be noted in respect of high frequency apparatus and that is, that although it will give a reasonably sharp definition of objects radiographed or examined by the fluoroscope, the intense sharpness that can be obtained by a static machine is absent in this case. The reason is chiefly that in the case of the high frequency coil the discharges are oscillatory in character, and cause a slight diffusion of the X rays, while from a static machine the discharges are in one direction and show a clearer outline.

A close approximation to the sharp definition of the static machine may be obtained by using with the high frequency coil a diaphragm consisting of a sheet of metal with a hole about 1 to 1½ inches in diameter cut in its centre. This is placed in front of and about one inch away from the tube, covering all of it except immediately in front of the third, or bombarded elec-



trode, and thus cutting off the diffused or scattering rays. Such an arrangement need only be used when it is desired to obtain especially sharp definition of some particular part of an object to be radiographed or examined. It is not generally necessary when the object is near the surface that is nearest the sensitized plate or the fluoroscopic screen.

## CHAPTER VIII.

## STATIC MACHINES.

IN discussing induction coils and transformers we have been dealing with electricity in motion, usually known as *dynamic* or *current electricity*, but in the type of machines now to be considered we shall find what is termed *static* electricity or *electricity at rest*. In the former state the current may be considered as usefully manageable, while in the latter state it is less so, manifesting itself by attractions and repulsions and violent discharges.

So far as the employment of the electric current is concerned in producing the desired effects in induction coils, transformers and static machines, such effects are all the results of the phenomena of induction. In the two first-named types of apparatus, however, the induction is the direct result of the variation of currents flowing in adjacent conductors, while in static machines the inductive effects are due to the attraction and repulsion of opposite and like electricities.

The two first-named types of apparatus require a constant supply of electric current to ensure their action, while a static machine needs only an initial charge of electricity, which is generally present in a self-charging machine, or may be imparted as the result of friction in some form. When this initial charge exists or has been given, the active parts of the machine are set in motion and from the small charge there is quickly accumulated a greater one which will result in a constant discharge as long as the machine is kept in action.

It is well known that if a stick of sealing-wax, a rod of glass, a piece of ivory and many other substances (insulators in their nature) are rubbed with a piece of cat fur, flannel or silk, they acquire a new property and will attract light bodies, such as feathers, paper, gold leaf, etc. In this condition they are said to be electrified, and there is upon that part of the surface rubbed a static charge of electricity of either positive or negative kind, according to the nature of the substance and the article used as a rubber.

When light bodies are thus attracted to an electrified body they remain a short time in contact and are then repelled. They do not merely fall away but are actually repelled for the reason

that, during the time of contact, they have acquired a condition of electrification of like kind, and according to the law as laid down by eminent scientists, two similarly electrified bodies repel each other, while two oppositely electrified bodies attract each other.

It will be noted that in the example just given one body becomes electrified *by contact* with another body already electrified. This condition may also be produced by *induction* where the two bodies are not brought in contact with each other.

Suppose we insulate a glass ball upon a glass rod and place near it a metallic cylinder, also mounted upon a glass insulating rod, as shown in Fig. 18, and then rub the ball with silk. The ball will become electrified positively.

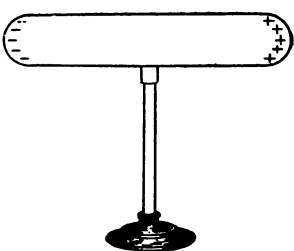
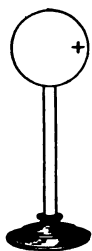

FIG. 18.

It will then be found that the cylinder has also become electrified by induction by reason of the presence of the ball. The positive electricity has, however, been

repelled to the further end of the cylinder while the ball has attracted towards itself negative electricity at that end of the tube nearest to it.

These effects will take place even if a sheet of glass were interposed between the glass ball and cylinder and would also be found if they were at some distance apart. The inductive effects would cease if the ball were removed altogether and no charge would be found upon the cylinder, although the ball might still be electrified.

If the cylinder should be connected to earth while the ball were in its proximity the positive charge would be repelled into the ground and none would be found on the further end of the cylinder, but a negative charge would still be attracted to the end nearest the ball.

Electricity in this state is said to be "bound" and "free." It is said to be "bound" when it is attracted and apparently neutralized by a charge of the opposite kind near to it, and "free" when it is not in the immediate presence of a charge of the opposite sign. For instance, in the illustration above given, the negative (or —) charge induced upon the end of the insulated cylinder is "bound" by the attraction of the positive (or +) electrification of the insulated ball, while the + charge repelled to the end of the cylinder furthest from the ball is "free," and will flow to the earth if a conductor be offered. The — charge on the cylinder, which is "bound" by

the + attraction of the ball will remain "bound" even if a conductor, or path, be offered for it to go to earth.

It may be superfluous as regards some of our readers but helpful to others in more readily

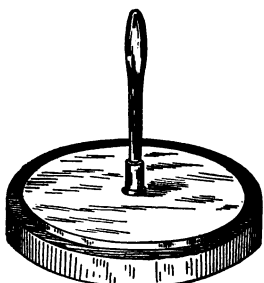

FIG. 19.

comprehending the philosophy of a Static Machine, to describe an instrument devised by Volta for procuring by induction a number of charges of electricity from a small initial charge. This instrument is called the "Electrophorus," and consists of a cake of resinous material and a disk of metal, or wood covered with tinfoil, in which is affixed an insulating handle of glass (Fig. 19).

If the cake be rubbed with a piece of dry, warm woolen cloth or a piece of fur, it becomes negatively electrified.

If then the disk is placed upon the surface of the cake, this negative electrification acts inductively upon the metallic cover and attracts a positive charge to the under side and repels a negative charge to the upper surface. This is shown diagrammatically in

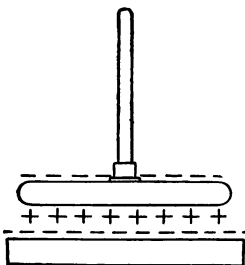

FIG. 20.

shown diagrammatically in

Fig. 20. In this case the + charge on the under side of the disk is bound, while the — charge on the upper surface is free.

If a conductor be offered to the free charge it will immediately escape to earth, leaving only the bound charge on the under side of the disk, as shown in Fig. 21. On lifting the disk the + charge will distribute itself over both the upper and lower surfaces of the disk. If the finger be brought near the disk a discharge of this positive electrification will manifest itself by causing a spark to pass, and the operation can be repeated several times with like results without renewing the charge upon the resinous cake. All these effects can be repeated indefinitely upon rubbing the cake as often as it loses its electrification.

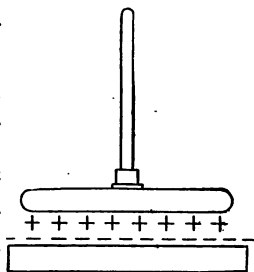

FIG. 21.

It will be quite evident, therefore, that if some mechanical means for performing these operations were devised there might be obtained a rapid and continuous succession of electrical discharges. As a matter of fact, quite a number of machines have been devised for the purpose of producing this result, since Volta first made

the Electrophorus in 1775, and while they are all of great interest as steps towards greater perfection, we shall confine ourselves to a brief description of those which have survived as the most efficient and generally useful, namely, the Holtz and Wimshurst machines.

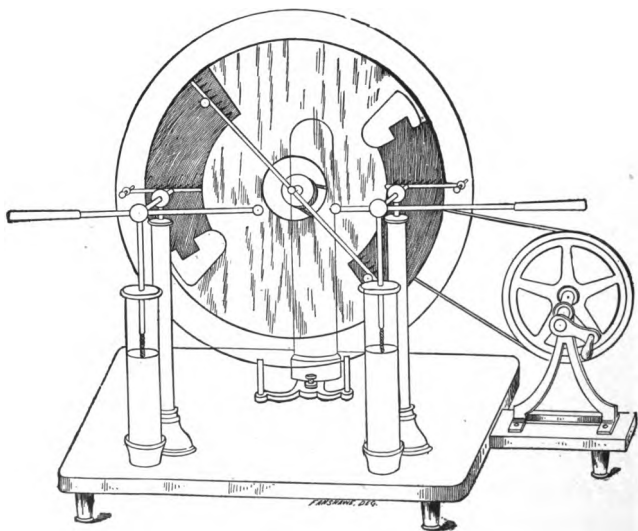

FIG. 22.

The Holtz Influence Machine, in its best known and simplest form, consists of two glass plates one of which is held by its edges in a fixed position and the other is mounted upon a spindle which is fixed in a standard at the back



of the machine. Upon the shaft of this latter plate there is a pulley attached, by means of which the plate may be revolved through the medium of a belt and driving pulley, as shown in Fig. 22.

Two holes are cut in the fixed plate at points diametrically opposite to each other. These are usually termed "windows," and a piece of varnished paper is fastened on the back of the plate near each of these windows, one piece being affixed above one of the windows, and a piece below the other one. These are termed "armatures." Each armature is provided with a narrow tongue which projects through the windows towards the movable plate, and pointed in a direction opposite to that in which this plate revolves, but so arranged as not to touch it.

In front of the movable plate a stationary conductor is placed, extending diagonally across the plate, at each end of which there is a "comb" consisting of a number of metal points directed towards the plate.

So far, all these parts are directly concerned in the action of the machine, but as it is desired to collect and utilize the electrical discharges some provision must be made therefor. On each side and in front of the movable plate are placed

horizontal metallic combs supported upon insulated holders. These combs are joined to brass rods terminating in brass balls and to these brass rods Leyden jar condensers may be attached. The discharges of the machine take place between the two brass balls.

When the character of the discharge desired is simply the "silent" or brush discharge, the Leyden jars are not connected, but when sparks of high potential are requisite the jars are used to obtain the result of the accumulated charge therein.

To start the machine it is generally necessary to impart to it a small initial charge, which may be done by electrifying one of the armatures with a rubbed glass rod, or any other substance previously electrified. Some machines are so constructed that a rubber plate conveniently placed will impart this initial charge to one of the armatures on being rubbed or struck with a piece of fur.

As soon as the initial charge has been given, the movable plate is rotated and the machine will very rapidly build up its charge, giving out a stream of sparks between the discharge terminals in a few seconds after the rotation is commenced.

Bearing in mind the earlier portion of this chapter as to the inductive effects of charged bodies and the consequent attractions and repulsions, the reader will find it comparatively easy to understand the action of the machine.

Let us first see what the result of the initial charge is without rotating the plate. We will suppose that we have imparted a + charge to the armature on the right hand side. This charge acts inductively across the glass and air and negatively electrifies the comb on the lower end of the diagonal conductor, repelling a + charge to the other end of this conductor. This, in turn, discharges + electricity upon the front surface of the plate which acts inductively upon the other armature, charging that part opposite the comb with — electricity and repelling a + charge into the part farthest away, namely, the tongue. The tongues at the left and right are, therefore, discharging upon the back of the revolving plate positively and negatively electrified air, and the combs attached to the diagonal conductor are also discharging similarly upon the front of this plate.

On turning the plate around, the + charge discharged on the back by the left hand tongue comes over to the right side, and being free is discharged into the armature to which we origi-

nally gave the + charge, thereby increasing the strength of its charge and causing it to act more strongly than before. The — charge induced in the left hand armature now reacts on the upper comb causing a more powerful discharge of + electricity from its point and strengthening the charge drawn through the diagonal conductor.

It will be seen, therefore, that both the front and back surfaces of the movable plate are both positively and negatively electrified, the front from the induction originating from the armatures and the back from the inductive effects caused by the electrification of the front surface. It will also be noted that the + and — electricities upon the back of the plate serve to strengthen and maintain the original inducing power of the two armatures, while the surplus + and — electricities induced upon the front surface of the plate are, after the machine has arrived at its maximum charge, collected by the two horizontal metallic combs and discharged across the terminals in front of the machine.

There are various modifications of the original Holtz machine made at this date, the one most generally known being that originated by Toepler. This consists chiefly in affixing small metallic buttons on the front of the revolving





Made with Single-focus Tube and Wimshurst Machine, by Mr. H. C. Ogden, Middletown, N. Y.

plate and providing small wire brushes attached to the combs. Metallic arms are affixed to the armatures and so arranged as to touch the buttons lightly as they pass. Feeble charges exist in these buttons, and they therefore become carriers, discharging as they come in contact with the brushes attached to the combs. In other words, the buttons and brushes are provided so that excessively feeble charges if they exist may yet be transferred as if the machine were in full work and since the rows of points could not do that,—actual contact is essential. Such feeble charges always exist. Hence the machine is self-charging if in perfect order.

Holtz machines are very susceptible to moisture and dust; and are usually enclosed in cases for protection therefrom. Ordinarily an artificial drying agent such as chloride of calcium or sulphuric acid and pumice is introduced into the case to absorb any moisture that may arise and to ensure a perfectly dry atmosphere surrounding the machine. Such a machine should be kept in as dry a place as possible to obtain the most advantageous results from it in operation.

It is quite unusual in these days to make these machines with a single rotating plate, except for the more simple kinds of experiments.

Machines for X ray investigations are usually made with two or more revolving plates, some being made with as many as 24 plates. These, however, are quite elaborate and costly, and are only employed, generally speaking, by men of scientific attainments desiring to follow special lines of experiment and investigation. It may also be noted that the plates may be made of hard rubber and need not necessarily be of glass.

The commercial Holtz machines giving from 4 to 10 inch sparks are very desirable forms of apparatus for X ray investigations. Their discharges are not oscillatory, but in one direction, and, with single focus Crookes vacuum tubes, are capable of giving very fine results either for fluoroscopic examinations or in making radiographs. In the latter there is perhaps as little confusion of outlines as it is possible at this time to obtain. Such machines also have the advantage of being independent of batteries or electric light circuits. As we have already seen, their discharges are created by rotating the plates.

The reader must bear in mind, however, that we cannot get from nature something and give nothing in return. The rotation of a few plates, of themselves, require only a little expenditure of power, but when we generate electrical energy





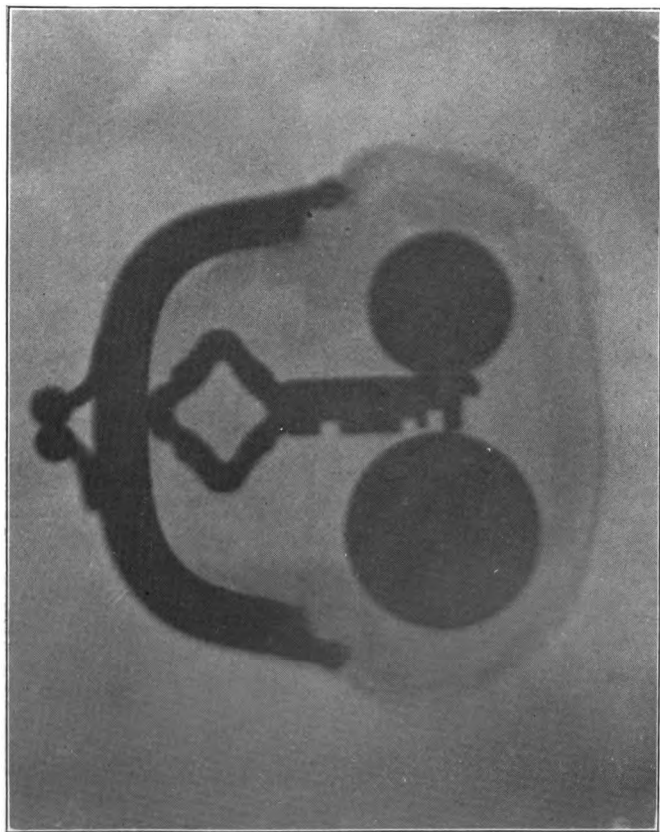

### **RADIOGRAPH**

**of Purse containing Coins and Key, made with Wimshurst Machine. The machine was operated at the time without condensers and at only about  $\frac{3}{8}$  inch spark.  
Made by E. W. Rice, Jr., Technical Director of the General Electric Co.**

thereby we must be prepared to give something in exchange therefor. This something is power, and while this does not amount to very much for a machine that will produce sparks of small length, it becomes an item for consideration when the sparking length reaches 6 to 8 inches. The reader is recommended to provide some motive power should he decide upon purchasing a large Holtz machine, for the reason chiefly that much greater regularity of operation can be thereby obtained and the results will be correspondingly better.

THE WIMSHURST MACHINE.—This is an apparatus of more recent invention than the original form of Holtz machine. It is shown in Fig. 23, and as will be seen, differs somewhat in arrangement from the Holtz machine.

In this machine there are at least *two* revolving plates but no stationary plate. It may be made with as many pairs of plates as are found desirable or necessary for the purpose, and the plates may be either glass or rubber.

Upon each plate is placed a number of strips of tinfoil or thin metal, usually called "sectors" which serve two purposes, namely, as carriers and armatures. There is an uninsulated diag-

onal metal piece in front of the face of each plate, each piece bearing at its end a soft metallic brush. A standard at each side bears collector combs on front and back, connected with the discharge terminals in front.

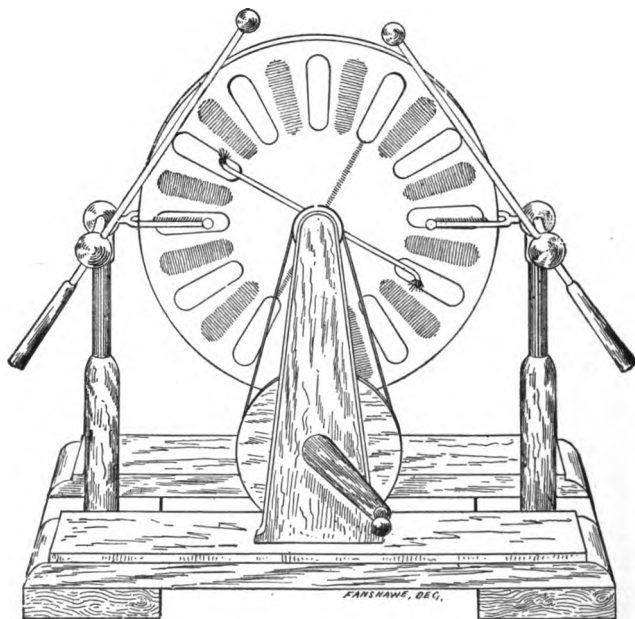

FIG. 23.

The action of this machine is, generally speaking, somewhat similar to that of the Holtz machine, that is to say, an initial charge is im-

parted and the inductive effects by attraction and repulsion are obtained.

Each of the carriers is touched by one of the brushes as it comes opposite the charged armature of the other plate, and the action of the machine is similar to that of the Holtz-Toepler previously described, the foil and brushes being for the same purpose as the buttons and brushes in that machine.

## CHAPTER IX.

## THE CROOKES TUBE.

THE reader whose acquaintance with electrical apparatus may be slight, or whose only knowledge as to the X ray phenomena may have been gleaned from the newspapers, might very naturally suppose that the name Crookes tube would indicate a piece of apparatus of some specific and definite shape and size.

Such, however, is not the fact. The name of "Crookes," as applied to an exhausted glass tube of any size or shape, either with or without electrodes, indicates the degree of vacuum which the tube should possess. The eminent English scientist, William Crookes, after extensive researches upon the subject of electrical discharges in high vacua, gave to the world, in 1879, the valuable results of his studies and experiments in this direction, and developed a series of tubes of a certain degree of exhaustion, by means of which certain interesting phenomena, until then unknown, might be observed.

A Geissler, Crookes, or other vacuum tube may be generally described as consisting of a glass chamber of spherical, cylindrical or other shape, into which is sealed, by means of platinum wires, two or more metallic electrodes which serve to carry the electric current into and out of the bulb. These tubes can also be made without electrodes being carried into the interior, tinfoil, or other metallic electrodes being fastened to the outside or placed in close proximity thereto. These latter types of tubes are rarely used, however, by reason of their lower degree of efficiency and a greater liability to puncture.

Prior to the researches and discoveries of Crookes, experiments had, for many years, been made with electrical discharges in vacuum tubes, or in tubes containing various gases, by Geissler and others, but the vacua in these tubes were not of the high degree attained in the Crookes tubes. The phenomena observed in these low vacuum tubes were very striking and beautiful, and in fact, Geissler tubes are largely used at this day in demonstrating certain features of electrical discharges under such conditions. Low vacuum tubes, are chiefly remarkable for the striae and beautiful luminous effects which they exhibit when an electrical discharge is

passed through them. These effects are due to various causes which may be, respectively, the degree of vacuum, the various kinds of gases or liquids contained in the tubes, or the different kinds of glass of which they are made, or a combination of two or more of these items.

The luminous effects produced in Geissler and other comparatively low vacuum tubes by electrical discharges are said to be due to the violent agitation of the molecules of the gases therein, and by the constant collision of such molecules with each other during the period of such discharges. Ordinarily, the molecules in a low vacuum tube have a tendency to move in straight lines, but their average "Free path" is very short and they collide with each other, producing the characteristic cloudy luminescence. A vacuum tube of this kind has, by comparison with a Crookes tube, a high internal pressure. With greater rarefaction of the tube, and a consequent lowering of the pressure, or, in other words, a higher degree of its vacuum, the "Free path" of each molecule becomes longer and they move in straight lines with less mutual interference than before.

The cloudy, luminous effects observed in the low vacuum tubes are not present in the Crookes



tube. Instead, the whole interior of the latter tube is clear, but the glass of the tube itself assumes a beautiful fluorescence which it retains as long as the electrical discharge is continued. The fluorescence is the most brilliant at that part of the tube opposite the cathode electrode. This fluorescence of the glass is never present in a Geissler or other low vacuum tube; indeed it is one of the infallible signs by which a Crookes tube may be recognized. In many Crookes tubes there will also be observed a continuous succession of brighter fluorescent flashes along the glass in that part of the tube nearest the cathode electrode.

The color of the fluorescence of the glass will vary according to the kind of glass used for making the tube. In some kinds of hard, German and other glass, the fluorescence will be of a bright apple-green color, while in other kinds the color will vary from a lighter green to a canary color. Some kinds of lime glass have a mottled fluorescence of uncertain color, while lead glass fluoresces a beautiful robin's-egg blue.

Tubes of the types designed by Mr. Crookes have been quite extensively used by experimenters and in institutions of learning for many years for demonstrating the numerous and

interesting phenomena incident to electrical discharges in very high vacua, but it was not until after the discovery by Professor Roentgen of the X rays that much special attention was paid to the fluorescence of the glass of the tube. In the

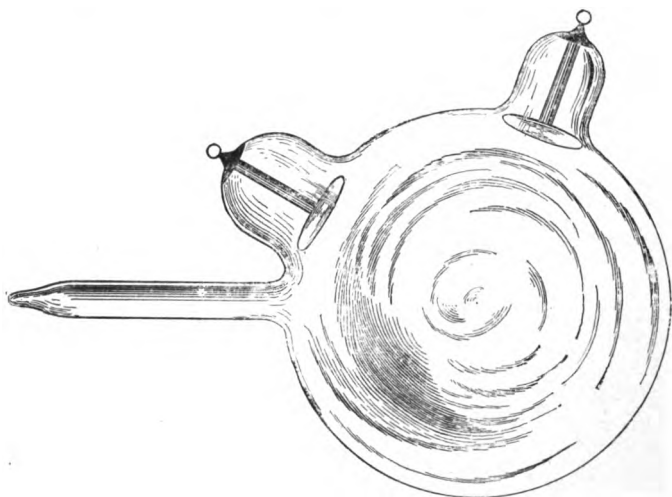

FIG. 24.

announcement of his discovery it was stated that the X rays apparently proceeded most strongly from that part of the Crookes tube opposite to the cathode electrode, the point of greatest fluorescence of the glass.

It was found by others who took up this line of experiment that the greatest amount of X rays

was obtained from this point when using Crookes tubes of the type in which the electrodes were so placed that the rays therefrom were directed against the glass of the tube itself. Two of these types of tubes are illustrated in Figs. 24 and 25.

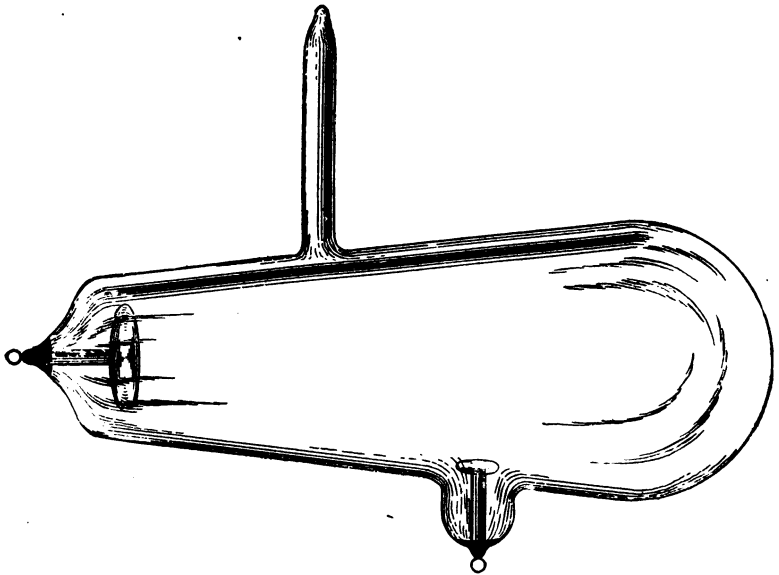

FIG. 25.

The illustrations show two of the types of Crookes tubes that were used to obtain the earlier results in X ray experiments, indeed the pear-shaped type is still successfully employed

for the same purpose, although the more advanced investigators have begun to realize the greater advantages of the focussing tubes which we shall presently discuss.

On referring to Figs. 24 and 25, it will be seen that the electrodes consist of flat metallic disks. These are usually made of aluminum. It will also be seen that both of these disks face some point of the glass tube, without interfering with each other, and that one of the disks is larger than the other.

In practice, when either of these types of tube is used, the larger disk is so connected as to become the cathode, and the smaller disk the anode. When the current is turned on, the cathodic stream caused by the electrical discharge strikes the glass at the part opposite the negative electrode, and, if the tube is properly made, the characteristic fluorescence will at once appear, but strongest and best on the glass opposite the cathode. It is also at this point that the X rays are produced and may be observed with a fluoroscope or by means of a sensitized photographic plate. Little, if any, manifestations of the presence of the X rays are noticeable at the point opposite the anode electrode.

Although Crookes tubes of the types illus-



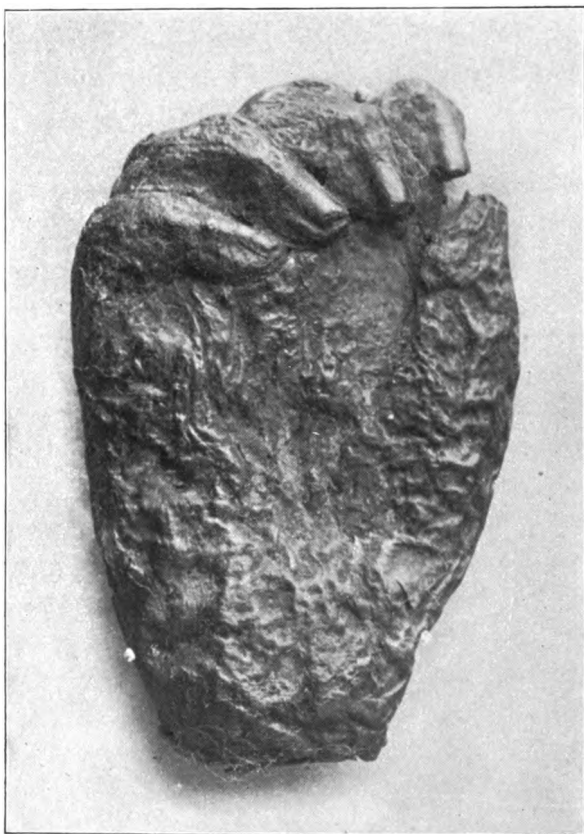

**PHOTOGRAPH.**

**Mummified Hand of an Egyptian Princess, obtained near the Tombs  
of the Kings, Thebes, 1892.**

**The hand is believed to be between 3,000 and 4,000 years old.**

**Half-tone: Etched, using Carbutt Process plates.**



### **RADIOGRAPH**

**of Mummified hand on preceding page, made in the Laboratory of  
the Keystone Dry Plate Works, on a Carbutt X-Ray plate, by  
John Carbutt.**

**Half-tone : Etched, using Carbutt Process plates.**

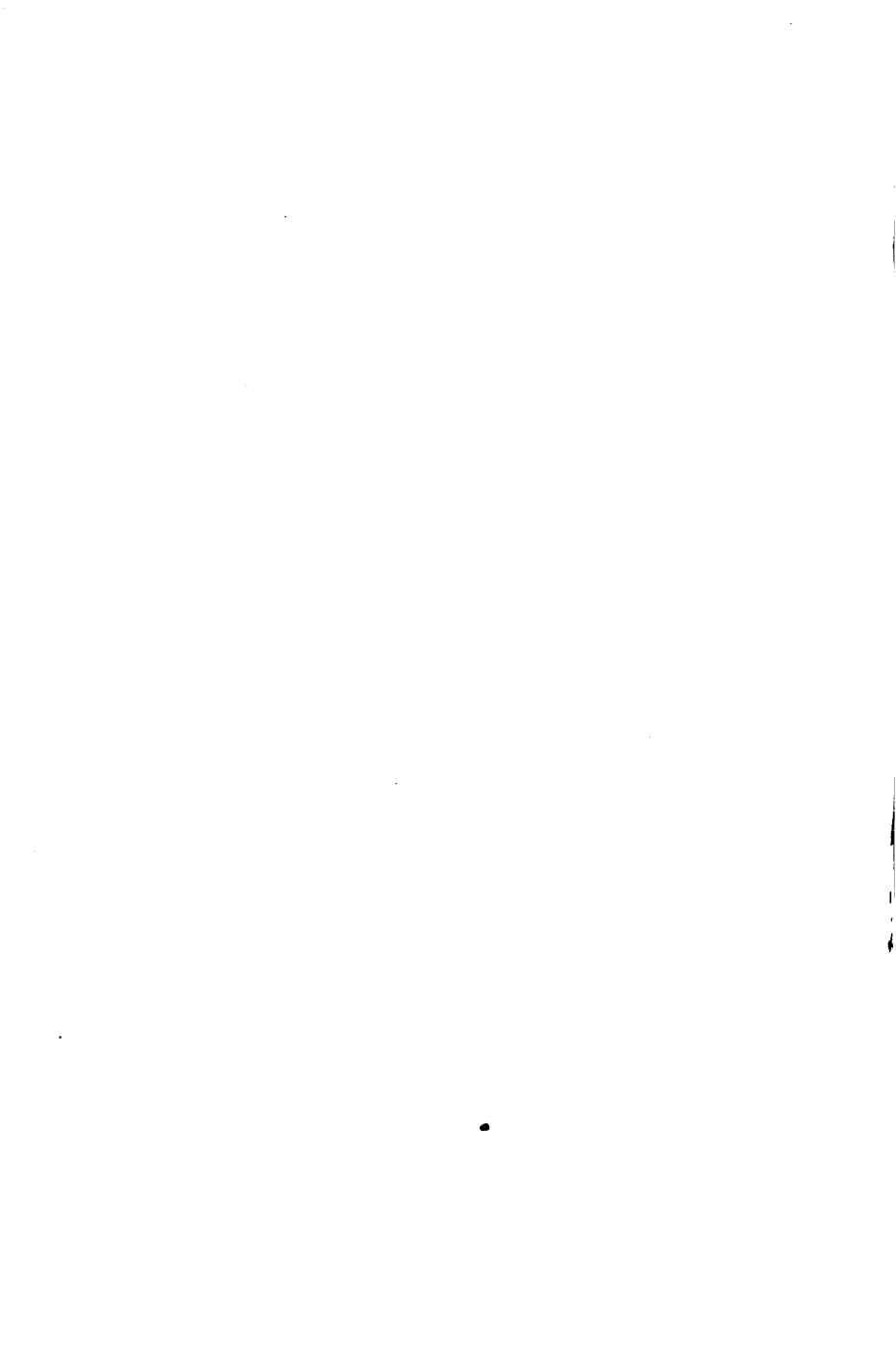



trated in Figs. 24 and 25 have been, and still are, successfully used in the production of the X rays, they do not represent the best type of tube for this purpose. In the first place there is great diffusion of the rays, originating as they do from the cathodic stream proceeding from a flat metal disk having no point of focus. This diffusion gives rise to a more or less blurred shadow of objects as seen in the fluoroscope or as shown in a radiograph made upon a sensitized plate. This lack of sharp outline, however, is less in degree if the X rays produced by this type of tube proceed from electrical discharges generated by a static machine. The reason of this is that these discharges are usually in one direction and have less of the oscillatory character accompanying the discharges from apparatus of the induction coil type.

The diffusion and consequent lack in sharpness of outline may be overcome to some extent by the use of a diaphragm, as we have already explained. While greater definition may be thus obtained, the use of a diaphragm necessitates a longer exposure in taking a radiograph.

There is another undesirable feature of the type of Crookes tubes with which we are now

dealing, namely, that type in which the X rays proceed from the point of the glass directly bombarded by the stream of cathodic rays. This feature is the heating of the glass at that point.

It may not be generally understood that the stream of cathode rays generates considerable heat at the point where it strikes, but such is the fact; and the more powerful the source of this stream, the greater the heat. The writer has seen, in a tube of the type illustrated in Fig. 25, ten inches in length, a spot as large as a five cent piece, opposite the cathode, become almost red hot in about three minutes under steady excitation of the tube with a 9 inch spark coil.

This heating is much greater in a new tube than in one that has been in use, at intervals, for some time.

Indeed, it is customary for those acquainted with these facts to "cure" tubes of this type before putting them to constant use. The "curing" of a tube is accomplished by running it on a comparatively light discharge for a few seconds at a time, with intervals of a similar or greater length of time, and continuing this treatment for an hour or two. After being "cured" in this manner the tube will develop less heat than before at the point above mentioned, and is

then ready for practical use in X ray work. It should be added that there is also considerable heat developed at that point of the glass that is opposite the anode electrode, but not of so great a degree as at the cathode. This is also modified when the tube is cured, as the vacuum is then higher.

Many Crookes tubes of this kind are spoiled when new by the heating and melting or cracking of the glass soon after the current is applied, and even tubes that have been cured will ultimately be destroyed in this way, although, by means of careful manipulation, they have previously had a long and useful life.

And now, having described the general forms of the Crookes tubes that were so successfully used for the earlier demonstrations of the X ray phenomena, let us see what the natural progression of ideas on the subject has brought forth with the view of perfecting our knowledge of this new and wonderful discovery. Before proceeding, however, it may be well to note that some of the newer forms of Crookes tubes are known under names that are employed to distinguish them, either commercially, or as the invention or design of individuals. It should be borne in mind that, at this day, all forms of

vacuum tubes that are capable of use for the production of the X rays may be properly classified under the generic title of "Crookes Vacuum tubes," while the later forms, such as "double focus" and "single focus," tubes which were especially designed for purposes that Mr. Crookes could not have had in mind, may be considered as species.

It will be remembered by most of the readers of this book that Mr. Edison was among the earliest of the X ray experimenters in America after the announcement from abroad of Professor Roentgen's discovery. Taking up the subject in his characteristic way, Mr. Edison made an endless variety of forms of Crookes tubes, and, after numerous experiments, finally decided upon the adoption of a form substantially as illustrated in Fig. 26.

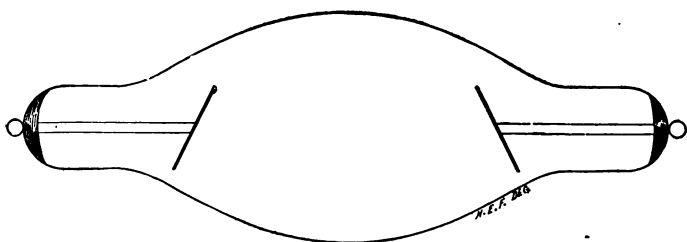

FIG. 26.

It will be seen that in the Edison tube the two

electrodes are opposite each other, each electrode being inclined at an angle. Under the influence of oscillating discharges each electrode will alternately become anode and cathode and the X rays may be observed at that part of the tube against which the cathodic streams are directed. This tube was a great advance for X ray investigations over the forms just described. The rays are abundant, and comparatively clear definition of opaque objects interposed between the tube and a fluorescent screen or sensitized plate can be obtained.

This form of tube has been very successfully used by Mr. Edison in his investigations of the X ray phenomena for several months past. It is also worthy of note that it was the form of tube employed in the four weeks' public exhibition given by him in May, 1896, at the National Electrical Exposition in New York City, when many thousands of persons saw for the first time the manifestations of the X ray phenomena.

The disadvantage of diffusion of the source of the X rays proceeding from the earlier forms of Crookes tubes became apparent as soon as the investigation of the phenomena brought to light some of the possibilities incident to the applica-

tion of Professor Roentgen's discovery. There seemed to be but one way in which sharp outlines could be obtained, and that was to bring the rays to a focus. There appeared to be considerable difficulty in the way of accomplishing this object, as the X rays could not be refracted or condensed by lenses such as are used to focus rays of light.

From the time that the discovery of the X rays was first published, probably no one in the United States has been a closer or more enthusiastic student of the subject, not only from the theoretical but also from the practical point of view, than Professor Elihu Thomson. After making a somewhat exhaustive series of experiments with the types of Crookes tubes that were known in the earliest history of the subject, it became a settled conviction in his mind that the most efficient type of vacuum tube for practical use in X ray experiments was one capable of focussing the cathodic rays and projecting them, so focussed, in straight lines.

As early as January, 1896, Professor Thomson used in his X ray experiments a standard form of Crookes tube, as shown in Fig. 27. This tube had a piece of platinum in the centre and a concave cathode of about one inch in diameter at one

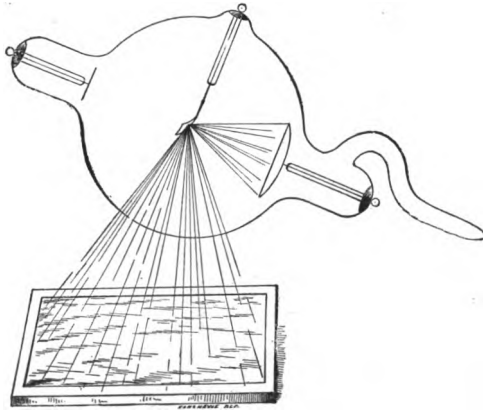

FIG. 27.

end. The rays came to a focus on the platinum and X rays were produced in abundance and sharp definition was obtained by him from this focussing tube. This same form of standard Crookes tube was also used early in 1896 by a few other experimenters, among whom were Mr. Shallenberger and Mr. Scribner. In April, 1896, it was announced in the technical journals, that a tube of substantially the same design had been brought out in England for X ray investigations and used successfully. This form is known commercially as the single focus tube.

In the light of investigations made by him with Ruhmkorff coils as exciters, Professor Thomson

had arrived at the conclusion that the nature of the discharges in a Crookes tube was to some extent oscillatory. In designing a vacuum tube

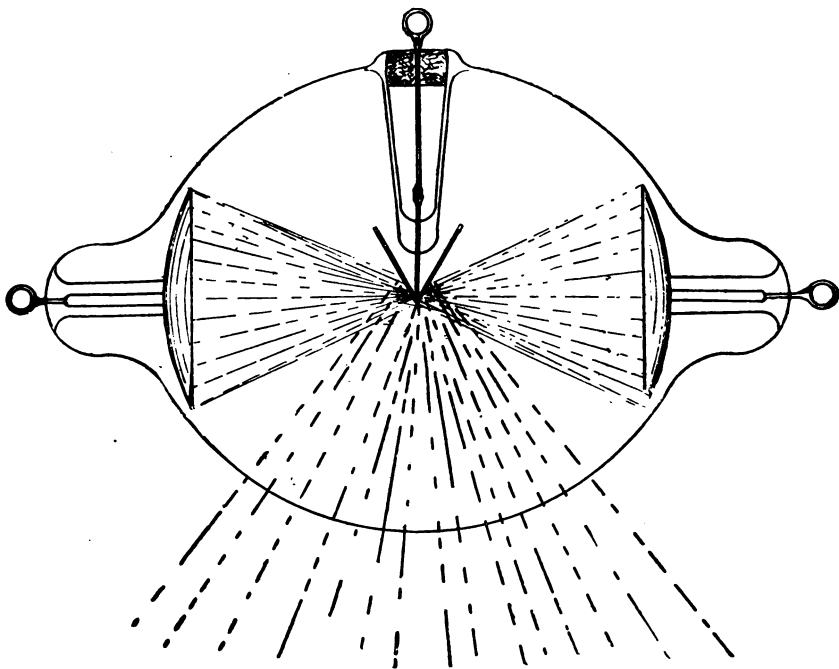

FIG. 28.

which would focus the rays, it appeared desirable, therefore, that the tube should be one that would be capable of doing so under discharges of such



a nature, and at the same time be useful as a focussing tube under discharges of a uni-directional nature, such as those derived from a Holtz or Wimshurst machine. The ultimate result of his deductions and experiments was the double focus tube illustrated in Fig. 28.

This form was intended as one capable of universal application to the discharges of all known kinds of exciting apparatus.

It will be seen, on referring to the illustration, that there are two concave electrodes placed diametrically opposite to each other and between them another electrode, wedge-shaped. The latter electrode is made of platinum and the other two are made of aluminum.

In using the double focus tube in connection with a Ruhmkorff coil, the terminals of the two cups are connected together and then connected with the cathode, or negative terminal, of the coil. The terminal of the wedge-shaped electrode is connected with the positive, or anode. When the current from the coil is discharged through the tube, the two cathodic streams bombard the platinum wedge, and the two cathode electrodes being cup-shaped, the cathodic rays are focussed to a point and strike the anode upon each side. The X rays are thus produced in great abundance and are

projected from the anode electrode in straight lines normal to its surface.

If the double focus tube be used upon a high frequency coil actuated by an alternating current, one of the two cups is connected to one terminal of the coil and the other cup to the other terminal, for the reason that, as the current alternates rapidly, the polarities of the coil terminals are also alternating with the same rapidity. Thus, each one of the cups is first anode and then cathode, and so on, each of these changes or alternations taking place in a very small fraction of a second. The results are very similar to those obtained by using the tube in connection with a Ruhmkorff coil.

When used with high frequency apparatus the terminal of the platinum wedge may be grounded. This is not necessary, however, although the results may be somewhat increased by doing so.

To use the double focus tube on a static machine only one of the cups and the wedge-shaped electrode are connected to the terminals of the machine. As we have already stated, the discharges from such a machine are seldom oscillatory, but generally in one direction, and no useful result with small output machines would follow from making connections so as to have

two cathodes in this case; indeed it would probably be disadvantageous as the force of the cathodic stream would be split up and the X rays produced might be of less power. On the whole, the double focus tube is perhaps not as desirable for use with the static machine of small output as the single focus tube.

When employed in connection with the other types of exciting apparatus, however, the double focus vacuum tube is all that can be desired. It gives sharp definition of opaque objects examined with the fluoroscope, and also enables the operator to make good radiographs of such objects upon photographic plates. With exciting apparatus of some power the X rays are produced so abundantly and with such power that the exposure required for radiographs is reduced to a low point, and fluoroscopic examinations may be made with much certainty and satisfaction.

The single focus tube, as illustrated in the technical journals, in April, 1896, was very similar to the standard form illustrated in Fig. 27, and consisted of a glass globe containing an aluminum cup for the cathode electrode and a disk of platinum set at an angle of about 45 degrees for the anode electrode. The cathodic rays focus upon this anode disk and are projected

forward therefrom, as in the case of the double focus tube.

It is not absolutely necessary to use a round disk of platinum for the anode of a single focus tube; a square, triangular or star-shaped piece is frequently employed by manufacturers in this country as illustrated in Fig. 29. The single

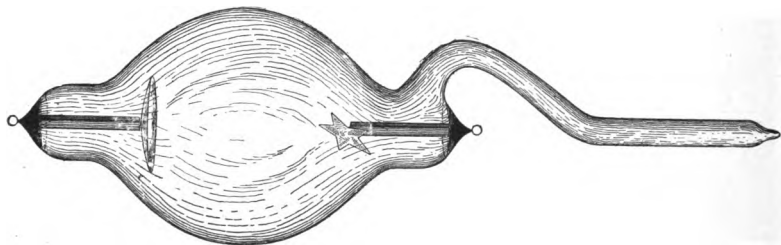

FIG. 29.

focus tube when well made is a most excellent one for the production of the X rays. It also gives sharp definition of opaque objects examined or radiographed, and is capable of use for most of the advanced class of work now carried on. This type of tube is, however, better adapted for use with static machines and the smaller and medium sizes of coils rather than in connection with the high frequency apparatus or large coils.

This chapter would not be complete without some mention of (1) the natural rise of the

vacuum in a Crookes tube when in constant use; (2) the effect thereof; and (3) what can be done to bring back the vacuum to a condition of usefulness.

It is well known to those who have made extensive use of Crookes tubes in X ray investigations that, after some time, the vacuum will rise so high that the electrical discharges from the exciting apparatus cannot be forced through the tube. The fluorescent and the X ray effects will cease, and, usually, the inside of the tube will have a blackened dirty appearance. This is due to the disintegration of the platinum wires or the platinum electrode and the depositing of the particles on the wall of the tube. These particles are driven off under the influence of the electrical discharges and, upon cooling, they, as well as the wires and electrode, absorb or condense gradually what little residual gas is left in the tube, thus creating almost an absolute vacuum.

As an electrical discharge will not pass freely in a vacuum of this kind, the tube thus becomes useless for the generation of the X rays. If the outside of a tube in this condition be heated by the flame of a Bunsen burner or spirit lamp the particles of platinum will throw out the air they have absorbed and by causing the discharges to

take place while the tube is in this heated condition, the characteristic fluorescence and the X rays will again appear.

This, after all, is but a temporary expedient, and is only successfully applicable a limited

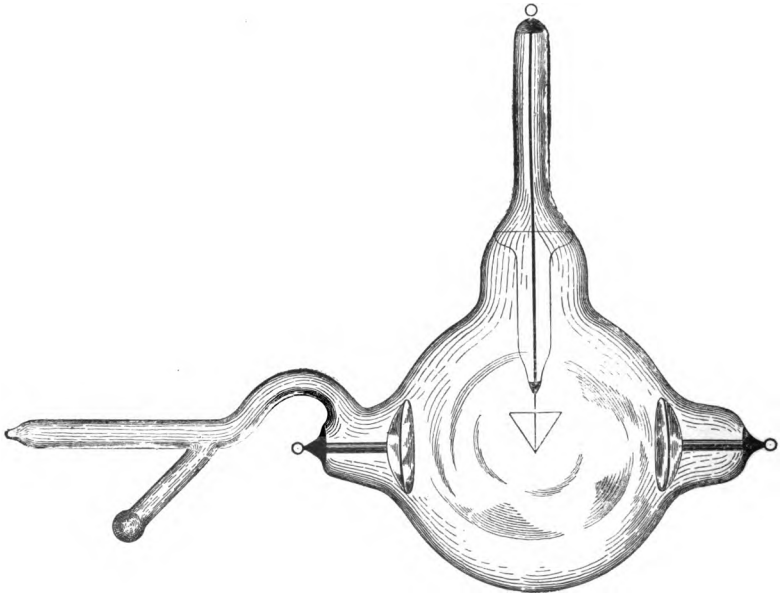

FIG. 30.

number of times. With each time of heating the subsequent usefulness of the tube becomes less and less, until finally no further work can

be obtained from it. The only recourse when that time arrives is to have it re-exhausted by the manufacturer.

Professor Elihu Thomson has provided in his double focus tube for this difficulty. He attaches to the stem (see Fig. 30), a small auxiliary tube containing a quantity of a chemical substance which has the property of discharging vapor upon being heated. The Thomson tube when completed in the factory is exhausted to the proper degree of vacuum so as to give fluorescence and produce the X rays, just in the ordinary way. When, in course of time, after some use, the degree of vacuum has risen so high that the X rays are no longer given out, a gentle heat is applied to the small auxiliary tube and immediately sufficient vapor is driven off to bring the vacuum down to the proper degree, and the X rays once more manifest themselves in abundance.

This operation is repeated as often as necessary, and in this way the usefulness of the tube is prolonged for a great length of time. If the chemical substance in the auxiliary tube should not outlive the main tube itself, another small tube with a new supply can at any time be affixed.

The auxiliary vacuum adjuster tube is also affixed to single focus tubes, and may also be placed on all other types of Crookes tubes. It is, however, advisable, if one should desire to put it upon an especially valuable tube, to have it done by those who are expert, as it is quite a delicate operation, to say nothing of the increased difficulties attending the subsequent re-exhaustion.



## CHAPTER X.

## THE FLUOROSCOPE.

As stated in a previous chapter, the Fluoroscope owes its existence to the fact that certain crystalline chemical salts possess the peculiar property of exhibiting fluorescence when brought within the sphere of influence of the X rays. There are several chemical salts that possess this peculiarity, but only two kinds have up to this time been found most generally useful. One of these two is platino-cyanide of barium and the other is tungstate of calcium. The crystals known as platino-cyanide of potassium also possess this fluorescent property, but from the fact that they are apt to deliquesce, or turn to liquid, under the influence of the ordinary atmosphere, this particular crystal has not found favor for use in this connection.

For some time after the discovery by Professor Roentgen, of the X ray phenomena, platino-cyanide of barium was the only chemical

crystal generally known to exhibit fluorescence. Mr. Edison, however, in one of his characteristic searches, discovered that tungstate of calcium exhibited as much, if not a greater degree of fluorescence. The calcium tungstate also possessed the merit of costing only about one-third of the other salt, in fact, since its fluorescent properties were first announced by Mr. Edison, the price of tungstate of calcium has been reduced in cost so that it can be purchased at about one-ninth of the price of platino-cyanide of barium.

To Mr. Edison should also be ascribed the credit of making the practical device known as the Fluoroscope, by means of which these fluo-

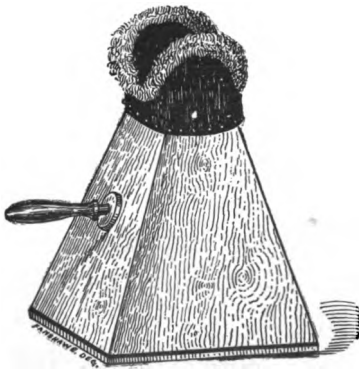

FIG. 31.

rescent salts can be practically used by even the most inexperienced person for the purpose of observing the influence of the X rays thereupon. A brief description of this device will enable the reader to fully appreciate its practical value.

Leaving out of consideration for the moment

the question of size, the fluoroscope may be described as a tapering box provided at one end with an opening edged around with some soft dark-colored material into which the upper part of the face will fit closely and exclude light (Fig. 31). At the other end of the box is placed what is known as a "fluorescence screen." This is made either of cardboard, wood, thin aluminum, thin hard-rubber or any other substance through which the X rays can easily penetrate. The inner side of this screen is coated with the crystals of either platino-cyanide of barium or tungstate of calcium, most generally the latter. The whole apparatus is made as light-tight as possible, with the exception of the opening at the top which is intended for the observer to look through.

The most important feature of the fluoroscope is the screen, of course. If the crystals are not evenly distributed, that is to say, if they are thickly distributed in one place and thinly in another, the fluorescence of the screen will be unequal in brightness. A great deal therefore depends upon an equal distribution of the crystals and upon getting the coating of a proper thickness. Naturally, the quality of the fluorescent material is also an important item, but

that which is now generally to be had in the market is found to be of sufficiently good quality to give fair results.

As stated in the first chapter of this book, the crystals upon the screen will exhibit fluorescence if the X rays are not interfered with by opaque objects placed between the Crookes tube and the screen.

In making examinations of objects through the medium of the X rays, the observer places the fluoroscope to the eyes so as to shut out any outside light. If there are X rays present, the screen will glow with the characteristic fluorescence, resembling somewhat a ground glass window pane as seen at night with a light at some little distance away and behind it.

Let us suppose that the observer wishes to examine some object, as for instance, a lead pencil. The pencil should be placed against the outside of the screen, and as close to it as possible. Upon looking through the eye-piece there will seem to be only a very thin straight line, and if the rays are particularly strong and penetrating, nothing else will be seen. This is the graphite inside the wood. The rays penetrate the wood instantly and thus cast no shadow of it upon the screen. As the graphite in the pencil is more opaque to

the X rays they cannot pass through it so well, and for that reason cannot cause the fluorescence of the crystals upon that part of the screen immediately in front of the graphite of the pencil, consequently a dark line representing the graphite is seen upon the screen.

If the object placed in front of the fluorescent screen should be a leather pocket-book with coins

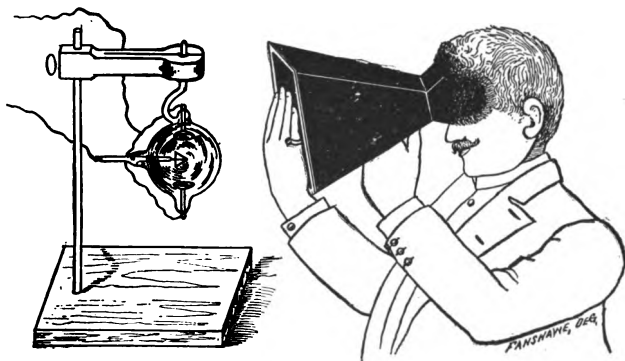

FIG. 32.

therein the X rays would in like manner penetrate the leather, and reach the fluorescent crystals and that portion of the screen which was immediately behind the leather would fluoresce just as if nothing were interposed. The coins being made of metal would, however, intercept the rays so that they could not strike the fluores-

cent crystals on the screen and thus the coins would be outlined and appear black to the observer looking at the screen. The same effect would be produced by placing the hand in front of the screen, and pressed tightly on the outside of the screen, and in front of the tube. The rays would pass through the flesh, blood, sinews and muscles, but the bones being opaque, their shadows would be cast upon the screen.

Of course, there is no permanent shadow left upon the screen by placing any objects in front of it as above mentioned. As soon as the generation of X rays ceases, there is, of course, nothing to cause the crystals to exhibit fluorescence, and the screen will, therefore, become dark. It is evident, therefore, that the fluoroscope is a device which can be used indefinitely if properly taken care of.

No sure rule can be laid down as to how close it is necessary to bring the fluoroscope to the Crookes tube which is being excited. Where the apparatus is very powerful and the tube is generating a great abundance of X rays, the fluoroscope will enable a person standing ten or twelve feet away from the Crookes tube to see the bones in his hand clearly.

This, however, is what might be considered

an extreme case. Ordinarily, the observation is made within one or two feet from the vacuum tube. With a very good double focus tube strongly excited the writer has known a screen to exhibit fluorescence 50 feet away, with two doors and a wooden partition interposed. This is also quite exceptional and should not be expected in ordinary practice.

## CHAPTER XI.

## THE SOURCE OF CURRENT.

IT does not need a very far-reaching view into the future to warrant the statement that a physician will soon be somewhat behind the times if he does not either possess apparatus for making radiographs and examinations by means of X rays or have ready access to such apparatus. In considering the acquisition of this apparatus the foremost consideration which presents itself is how to obtain the electric current by which it is to be operated. Physicians are usually very busy persons, whose time is fully occupied, not only during the day but frequently during the night. They are not exempt from professional demands even on Sundays or holidays. Consequently they dread, as a rule, the care and time which is necessary to operate a set of batteries and keep them in order.

Not only does this important question present itself to physicians but also to experimenters who desire to make a study of the X ray phe-



nomena. For the benefit of physicians and experimenters, it is proposed to classify the different kinds of apparatus which may be used for the exciting of Crookes tubes and state opposite each item how such apparatus may be successfully used. The following is a tabulated statement of this kind:—

<i>Exciting Apparatus.</i>	<i>Source of Operation.</i>
Ruhmkorff Coil.	1. Electric Light Circuit, direct current. 2. Batteries, either primary or storage.
High Frequency Apparatus (or X ray Transformer).	Alternating Current only.
Static Machine (Holtz or Wimshurst.)	1. Hand or foot power. 2. Electric motor. 3. Water motor. 4. Gas motor.

STATIC MACHINES.—From an examination of the table above referred to it will be seen that the only type of apparatus that does not absolutely require electric current either from a lighting circuit or from batteries is the Static machine. This machine generates its own electricity when the plates are revolved. The revolution of the plates may be accomplished either by hand or by a small motor of any kind that is sufficiently powerful for the purpose.

Usually static machines are manufactured in such manner, that they may be operated either by hand power or by the attachment thereto of a small motor, for which purpose pulleys are usually supplied. Of course, where it is practicable, it is much more desirable and convenient to revolve the plates by means of a motor, chiefly by reason of the greater degree of regularity obtained thereby, but when there are no conveniences to operate such a motor the X rays may be successfully produced and results obtained if operated by hand.

If an electric light circuit is available, either alternating or direct, a small motor capable of giving from one-eighth to one-half horse power can be applied to the ordinary commercial static machine and used for operating it. Such motors

are usually obtainable from any electric light company operating a station. In operating a static machine, no batteries, rheostats or other accessories are needed. Indeed, this is by all means the most simple and convenient manner of producing the X rays for the usual objects desired.

HIGH FREQUENCY COILS.—Taking up next the High Frequency apparatus (or X ray transformer) we note from the table above named, that the only method of operating this is by means of an alternating current. This apparatus is very easy of manipulation, and, as it is capable of use directly upon a lighting circuit, with the minimum of accessories, it is an ideal type of exciting apparatus where alternating current can be obtained.

There are to-day a very large number of cities and towns in which there are central stations supplying an electric lighting current by the alternating system. In some cases the voltage of the circuit may be from 50 to 52 volts, and in other cases from 100 to 104 volts. As a rule, the high frequency apparatus that is on the market is so made by the various manufacturers that it is available for any of these circuits. It

is generally necessary for the purchaser to merely specify the voltage and frequency of the current, which information can be readily obtained at the station supplying such current. In many of the largest cities of the United States there is a service of direct, or continuous, current, but no alternating current circuit, and inasmuch as the high frequency apparatus is one of the most powerful of all the X ray exciting apparatus, many persons will desire to use this type of apparatus where only direct current is available. In such cases it is quite possible to procure from some of the manufacturers of electrical apparatus motor-transformers by means of which the direct current can be transformed into an alternating current and so applied and used with the high frequency apparatus.

The motor-transformer is a very simple machine, consisting merely of a small direct current motor, having upon one end of the armature two collector rings making contact with brushes, to which are attached two wires. When set up, two conductors are run from the direct current circuit to the motor, and two wires carrying an alternating current run from the motor through a rheostat or regulating coil to the high frequency apparatus.

This apparatus cannot be operated by batteries except by a very complicated arrangement and with great trouble and at a very great expense. The only methods in which it can be worked is in accordance with those described above, and *always* by an alternating current.

RUHKORFF COILS.—As to the operation of Ruhmkorff coils, it will be seen by referring once more to the table that they can be operated satisfactorily only in two ways, either from an electric light circuit, direct current, or by batteries.

If no electric light circuit is available for the purpose, there are several kinds of batteries that may be used, namely: (1) Storage Batteries, or, (2) Primary Batteries, such as Bunsen, Grove, Fuller, Grenet, or the Edison-Lalande.

Taking up the above in their order, storage batteries are undoubtedly the best for the purpose, but, of course, the user must have some means of getting them recharged from a direct current circuit.

This is quite simple and convenient if it happens that the mains of such a circuit are convenient, as the batteries can be so arranged as to be

constantly connected and the charging current may be applied by turning a switch.

Of all the primary batteries enumerated, the Edison-Lalande is by all means the best, as it has a very large ampere capacity and does not deteriorate by polarization to any appreciable extent when not in use. While the voltage given by each cell of the Edison-Lalande battery is not quite half that given by the other types of primary battery above named, its large ampere output and non-polarization qualities make it very desirable for this class of work, when neither storage batteries nor direct current circuit is available.

It is, of course, quite feasible to operate a Ruhmkorff Coil directly upon an electric lighting circuit, if current from such source can be had, and the user does not desire to use batteries of any kind.

In such a case the quantity and potential of the current passed through the primary of a Ruhmkorff coil may be regulated either by a rheostat or a bank of lamps or may be obtained of the right potential and quantity by an auxiliary apparatus known as a rotary transformer, or motor-dynamo. The rheostat may be one of the ordinary kind, and the bank of lamps may consist of a number of

lamps arranged upon a board, the regulation in the latter case being accomplished by the turning on or off of a greater or less number of lamps. The rotary transformer consists of a motor taking current from the circuit and driving a small dynamo which generates the proper current for the coil.

While all three of these methods are somewhat uneconomical, many will prefer any one of them to batteries. Of these three methods, the simplest is probably the one which employs the ordinary rheostat as its use simply involves the shifting of a handle to regulate the amount of current required.

Although many experimenters object to batteries, it should be understood that there are good reasons for the use of storage batteries to actuate Ruhmkorff coils, even when a direct current circuit can be had. On the whole they are probably more economical and have a degree of regularity in potential that cannot always be relied on with such a circuit. They can also be arranged, as above stated, in permanent connection with the mains and in such a case will require a minimum of attention.

With such an arrangement, or with a rheostat or bank of lamps and direct current electric light

ing circuit available, the thought and attention of the operator may be concentrated on his observations and experiments with X rays, and the extra mental labor incident to side considerations as to the source of current may be avoided. The local electric light company is taking care of that part, and all that the operator need do to obtain current is to turn a switch.

There are and will be, however, a large number of cases where the experimenter will be removed from any source of electric current supply or power. In such cases there are only two types of exciting apparatus that can be used, namely, the induction coil or the static machine. The latter can be operated by hand, and we shall not need, therefore, to give any thought to the question of a supply of electric current, as the machine contains its own source of electrical energy.

Where there is no direct current electric lighting circuit convenient, storage batteries are, of course, out of the question, as they can only be charged from that kind of current. If, therefore, the experimenter wishes to use an induction coil and there is no regular electric lighting circuit available, the only source of energy will be that which can be obtained from primary batteries.



Any of the types of primary battery employing bichromate solution, or the Edison-Lalande cells, will be found suitable for this purpose. It is advisable to provide cells of ample size in order that a large ampere discharge can be obtained. We shall offer a few suggestions in a later chapter as to the number of cells required for ordinary coils.

## CHAPTER XII.

## MANIPULATION.

THE many questions constantly arising in connection with the manipulation of the apparatus used for production of the X rays require for their successful solution careful observation and thought. To many of our readers even the simplest methods may be entirely unknown. It will, therefore, probably be best to begin with a plain statement of the manner of arranging the apparatus to produce a radiograph or to make visual observations by means of the fluoroscope.

Let us therefore commence with what may be considered an amateur's set of apparatus, which may consist of, say, an induction coil giving a spark, of one inch and upwards. A coil of this size will probably have the regular form of contact breaker, namely, the vibrating armature already described. The condenser of such coil is usually contained in the hollow base upon which the coil stands.

A substantial, roomy table is always preferable for this work. The operator had best be provided with a stand or holder for his Crookes tube. An adjustable stand, that will enable the experimenter to place the tube in almost any position is the best for this purpose.

There are many good ones to be had in the market. The coil is placed a little distance away from the front of the table, the tube being placed near to the front of the table within easy reach. The batteries may be located under the table and the wires brought up to the coil. It is always advisable to have a switch in the circuit of one of the battery wires leading to the coil, so that the trouble of disconnecting the battery from the coil when it is desired to turn current off may be avoided.

The tube should be placed in the adjustable stand and the two wires from the secondary terminals of the coil connected to the proper electrodes. The wires connected to the tube should be of very small cross section, say, from No. 26 to No. 29, and need not be twisted or securely fastened to the terminals of the tube. It will be sufficient to hook them on loosely. If large wires are used to connect to the tube terminals there is

danger of cracking the glass and thus destroying the vacuum.

If the experimenter has provided a spark gap in the wires leading from the secondary terminals of the coil, as will be shortly described, the tube is, of course, connected with the wires leading from this spark gap. If it is desired to make a fluoroscopic examination the tube should be so placed in the adjustable stand that the cathode electrode will face the observer if the tube is one of the non-focussing type. If the tube is of the focussing type, it should be so placed in the stand that the anode faces the observer. (See Fig. 32).

The current may now be turned on in the coil and the electrical discharges will take place through the tube. If the tube has been properly connected and is producing X rays, their effect will be perceptible by the illumination of the screen in the fluoroscope when it is placed immediately in front of the Crookes tube. Objects may be examined by placing them closely in contact with the outside of the screen when it is held in this position. The open end of the fluoroscope should be pressed closely against the face to exclude any outside light.

While fluoroscopic examinations can be made

in a light room, the experimenter will always find it much more advantageous to have a room partially or wholly dark for the purpose. When the fluoroscope is used in a light room and the operator removes it from the eyes it takes perhaps ten or more minutes on renewing the examinations, to get the eyes back to the proper condition for making accurate observation of the fluorescent screen, as the eye is very slow to recover full sensitiveness.

The experimenter may not get much, if any, fluorescence upon first connecting up the tube to the coil. There may be two reasons for this: (1) that two connecting wires may be in contact with each other, and (2) that the anode and cathode terminals of the coil may not be connected to the proper electrodes of the tube. The remedy for either of these troubles is obvious.

If the experimenter now desires to take a radiograph, the current should be shut off from the coil until the sensitized plate has been placed in position. The tube should be so adjusted that the X rays will fall at the place where it is intended to locate the plate.

The plate may be placed either in an ordinary plate-holder, which should be closed in the regular manner with a slide (not of metal), or

the plate may be wrapped up in a piece of photographer's black paper, with sufficient folds to exclude light both from the sides and the ends. In so arranging the plate, care should always be taken that it can be so placed that the film side will be uppermost. The reason for this is that the nearer the object to be radiographed is to the film, the clearer the definition will be.

The plate as thus arranged may be placed on the table with the film uppermost to that point of the tube which shows the strongest effects of the X rays.

The object to be radiographed is so arranged that it will be at a distance of from, say 4 to 12 inches away from the tube and as close to the plate as possible. The current may be turned on and the exposure made. The current should never be turned on after this sensitized plate is brought near the Crookes tube until the operator has the object placed in position and is ready to make the exposure. After the exposure has been made the plate is developed in the usual manner as if an ordinary photograph had been taken upon it.

No specific time can be laid down as to the time of exposure that shall be made. With a small coil giving only one inch spark and a

focussing tube, a radiograph of a hand will probably be made in twenty minutes and of coins in a purse in nine or ten minutes. As the exciting apparatus increases in size and power the time of exposure grows less. As, for instance, with a coil giving a six inch spark and focussing tube, a good radiograph of the hand may be made in two to two and a half minutes, while with a coil giving a 12 inch spark and a double focussing tube a similar picture can be obtained in about a minute or perhaps less.

The time of exposure varies so much with the class, quality and power of apparatus used, that it is practically impossible to say definitely just what exposure shall be given in any specific case. This can only be determined in each case by the results of previous experiments.

Sometimes the experimenter may desire to stand his plate-holder or protected plate on edge to take a radiograph of some object. It should be borne in mind that objects may be tied fast to the plate-holder by means of thread or twine or even fastened thereto with rubber bands, but not with rubber tape. These fastenings will not show in the radiograph, as the X rays pass entirely through them and leave no shadow of them upon the plate.

Before dealing with the manipulation of the larger sizes of exciting apparatus we shall suggest to the reader more in detail the idea of the variable spark gap in the circuit leading from the secondary terminals of the induction coil. This spark gap is usually arranged for in high frequency apparatus and is also frequently used in operating static machines.

In Fig. 33 will be found an illustration of one

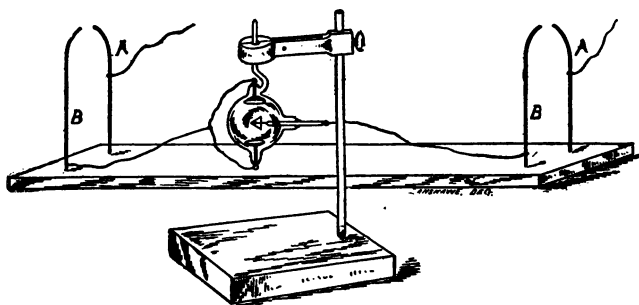

FIG. 33.

AA, Wires leading to discharge terminals of coil ; BB, Wires leading to tube.

practical method of making the variable spark gap. It will be seen that there are four standards arranged in two pairs upon a board. Each of these pairs has the ends of the standards bent and pointing toward each other, but with a gap between them.



The standards themselves may be four pieces of wire with the bare ends bent over as shown in the illustration. The standards should always be further apart than the greatest length of the spark capable of being given by the coil. The board in which the standards are mounted should be kept dry, and may be preferably mounted upon small blocks of glass, hard rubber, or other good insulator. It will be seen that on a standard at each end is connected a wire leading from one of the secondary terminals, and on the other two standards are thin wires leading to the Crookes tube.

The above is a suggestion for a rough-and-ready home-made spark gap. There are regular discharge stands made for the purpose, much more convenient to handle, now made and obtainable from dealers in X ray apparatus. These usually consist each of a small wooden stand in which is inserted a stout wire surmounted by a ball. The wires leading to the Crookes tube are fastened to these wires and the length of the spark gap can be regulated by moving the wooden stand.

In practice, it may be found unnecessary to have the two points in the spark gap separated. If, however, the vacuum tube does not appear to be

giving its best results, the points of separation in the spark gap may be increased, until after several trials the best results from the tube are obtained. It is not usually necessary to have a separation of more than an inch to an inch and a half as the extreme limit. With continual use a Crookes tube will rise higher in vacuum, and on slight increases of this kind the variation of the spark gap will be found very useful and conducive to better results. Vacuum tubes vary quite a great deal from each other, even when made by the same manufacturer, and each one will be found to have its individual peculiarities.

It has been noticed also, that some tubes will vary slightly from day to day. It has been found, however, that this spark gap is very useful in meeting such variations in most cases. Of course, if a tube rises so high in vacuum that no discharge can be sent through it, there is nothing to do but to have it re-exhausted, unless it is a tube of the adjustable vacuum kind, in which case the vacuum can be lowered in a few seconds.

Returning to the methods of manipulation, and taking up exciting apparatus of considerable power and capacity we find that the practical manner of taking a radiograph or making fluoro-

scopic examinations is substantially the same as detailed above for small coils. The chief difficulties will be found in the time of exposure necessary, the distance of the objects from the tube and in the method of making and breaking the circuit.

As we stated above, it is difficult to make specific recommendations as to the length of time of exposure in taking a radiograph of any object. Objects of small size, will, of course, require a very much shorter time of exposure than large or dense objects, although, in any event, the time of exposure increases with the distance of the tube from the object. Of the various parts of the human body, the hand and the adjacent ends of the arm-bones require a comparatively short time of exposure. A foot, ankle or other parts of the limbs require usually about three times as long an exposure for a radiograph of equal quality. To obtain pictures of portions of the trunk usually takes fully ten times as much exposure as for the hand and, even then, the apparatus must be in first-class working condition and an abundance of X rays generated.

The distance of the object radiographed by means of apparatus giving sparks of six inches and upwards should be six inches or more from

the tube. This, of course, refers to such parts as the hand, arm or foot, where the distance of the tube may be as great as twelve inches or more. In taking radiographs of the limbs it would be advisable, generally speaking, to have the tube only six or eight inches away to obtain a picture with the minimum length of exposure. A still shorter exposure can be made of such a part if only a very limited portion is desired to be shown on the plate by placing the tube two or three inches nearer. It should be remembered, however, that the greater the distance from the tube, the clearer the definition, although the exposure must be longer.

In taking a radiograph of a portion of the trunk, it is not always practicable to have the tube a long distance away from the body, as an exposure of several hours might, in such a case, be necessary.

In taking radiographs through the human trunk or through the thicker parts of the limbs, it is usual to shorten the time of exposure by placing a fluorescence screen between the object and the sensitized plate. The effect of this is to place next to the plate a screen which is rendered fluorescent by the X rays except in the parts where the rays are intercepted by the opaque

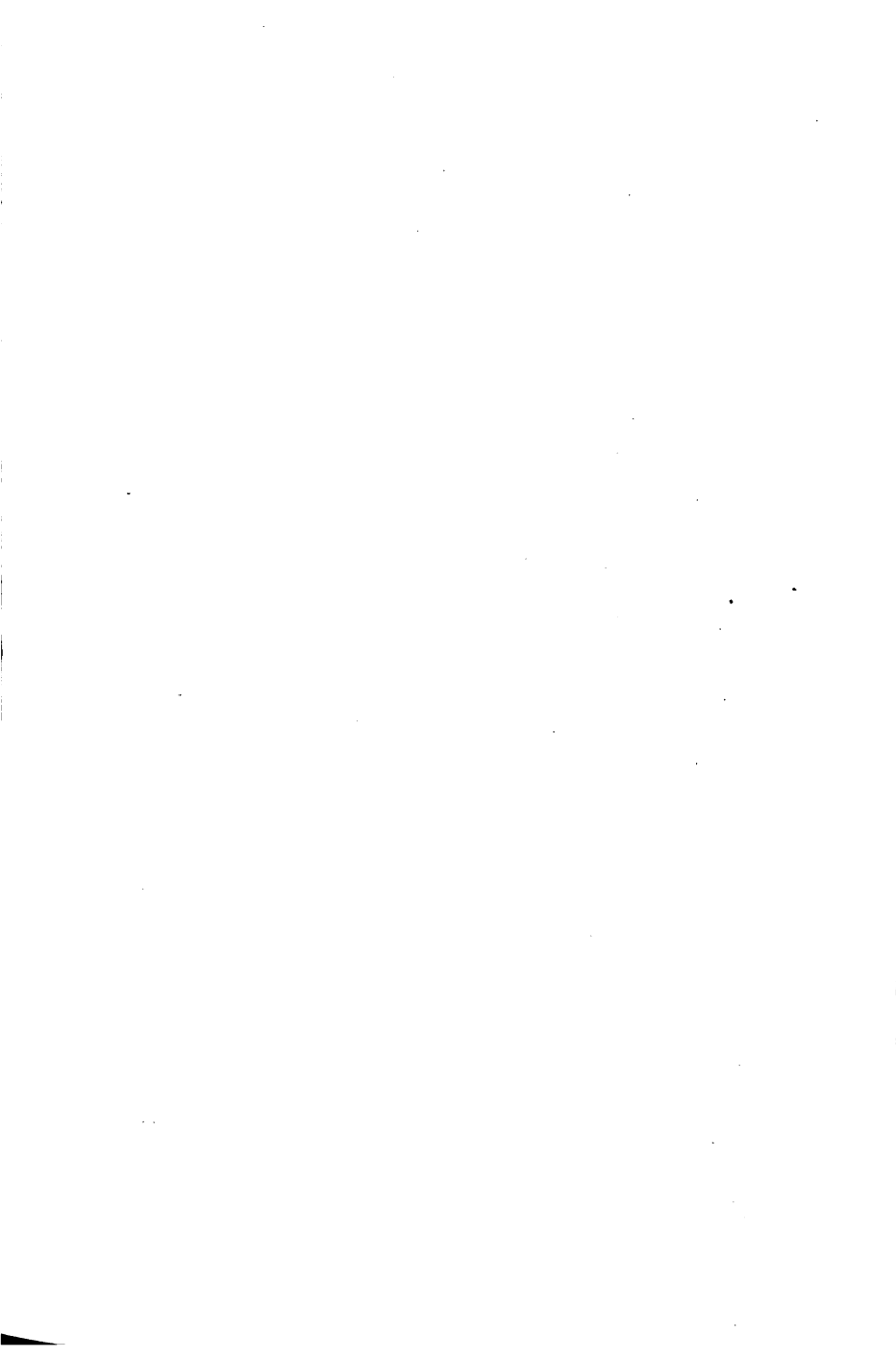



Fig. 34.

**RADIOGRAPH**

of Hand with Needle in Palm, made by the author with Thomson Double-focus Tube.

Time of exposure 2 minutes 20 seconds.

Distance from Tube 10 inches. Tube excited with Thomson Inductorium on 5 inch spark.

body, and the consequence is that the plate is affected by the light parts of the screen while the opaque parts will appear dark when the plate is developed and printed.

Sometimes it may be desirable to use a flexible sensitized photographic film tied over the part to be radiographed, as in the case of the hand containing a needle, shown in the illustration, Fig. 34. This hand was radiographed by the writer. The fingers were partially contracted and could not be opened, and the flexible film was tied to the inner portion of the hand by means of thread and a radiograph made by allowing the X rays to fall on the back of the hand.

While with small coils the ordinary form of vibrating contact breaker will answer most purposes for amateur experiments, it is advisable to use rotary contact breakers on those giving sparks of five inches and upwards. The rotary contact breaker is much more certain, rapid and satisfactory in its action than vibrating contact breakers, and it may be considered to be the only form desirable for use in practical X ray work. Its use is not necessarily confined to coils of a large size. It can be used in connection with coils giving one inch spark and upwards by disconnecting the vibrator parts and connecting in

place of them the rotary circuit breaker. This, however, will only commend itself to those who desire to go beyond the limit of the range of amateur experiments. For such it may be well to state that rotary contact breakers can be had in the market and are provided with motors that are capable of use either with batteries or upon electric lighting circuits.\*

It will probably be of interest to the reader to anticipate some of the troubles that may *possibly* arise in connection with his work or apparatus. It cannot be expected that, with constant use, apparatus of this kind will always work smoothly, but such troubles are not without their compensation, as it is by them that we most frequently gather our most valuable information.

We will suppose, for instance, that the reader is making experiments with a small coil having the regular form of vibrating contact breaker. Some day on connecting his tube he does not get the usual results. It is best then to begin with the coil, disconnecting the tube for that purpose and adjusting the discharge points of the secondary terminals to see if the coil is

\* Since the above was written there has been devised and perfected a special form of vibrating contact breaker which works as perfectly and practically as the rotary contact breaker.



producing its usual length of spark and of the same quality.

If the spark is irregular and smaller and thinner than it should be, it is possible that the trouble may be with the contact points upon which the vibrator works. These should be bright and clean and make good contact. If these are found in good condition, possibly the battery may need renewal of solution. If when this is tried the coil does not still work well, all the connections throughout should be examined to see if they are clean and firm, and if it then does not work, there is a possibility that the coil may have been injured in its insulation by being pierced with a spark.

If the coil is found to be all right the connections with the tube may be renewed and another trial made, and if the tube does not work well and if all the connections are clean, clear and properly made, and the tube still does not work well, the variable spark gap should be tried with all the variations that can be thought of, including the sparking of one polarity at a time. If an adjustable condenser is being used the various combinations of adjustment may be tried to advantage. Should the trouble appear to be with

the tube there may be one of two reasons, namely :—

1. The tube may be cracked or punctured. In this case it will be filled with a *dark* blue or purple cloud, or the spark will jump from one electrode to another inside of the bulb. Should the tube present either of these appearances, it is, beyond question, punctured or cracked, and nothing can be done with it for production of X rays until it has been repaired. If there is a thin, *light blue*, cloudy appearance around the electrodes, that is the indication of a low vacuum, especially if a slight fluorescence appears on some portion of the glass. This may be remedied by running the electrical discharges through the tube for some time (with spark gap closed) say, five or ten minutes, and letting the tube cool off for an equal length of time. Several trials of this kind should bring the tube up to proper fluorescence and put it in condition to produce the X rays.

2. The tube may have become too high in vacuum. In this case the electrical discharges will not pass through the tube; it will remain dark and little or no fluorescence of the glass will appear. Sometimes, the discharges from the coil will cause sparks to pass from terminal to terminal outside of the tube when the vacuum

is too high. There are two remedies for this, unless the tube in question happens to be one with an adjustable vacuum, one remedy being to gently heat the surface of the tube with a spirit lamp or Bunsen burner, and the other is to send it to the manufacturer for re-exhaustion.

If the foregoing does not seem to cover the trouble with the tube, it will be best to lay it aside for several days or perhaps longer. The writer has known Crookes tubes to work badly under apparently proper conditions, but after being laid aside for a week or ten days to work as well as they ever did.

The above remarks as to troubles that may possibly arise with tubes on small apparatus are applicable to tubes used on large apparatus. The same close search for broken circuits or bad contacts should also be made. If the operator is using a large induction coil with rotary contact breaker the trouble may be found in the brushes by reason either of their not bearing smoothly upon the metallic surfaces, or in the brushes having worn down irregularly, or the metallic contact surfaces of the contact breaker having become very dirty or very much cut up. There is also another possible source of trouble which may arise from small particles of metal having

been carried over the insulating surface of the contact breaker, thus destroying the completeness and efficiency of the break.

It is not intended to discourage the reader by these remarks, but to look forward to what may possibly happen, but what does not frequently occur in actual practice. Generally speaking, it is desirable to see that all parts of the apparatus are kept clean and free from dust and dirt and that all contacts are properly made and kept in good condition so that the maximum results may be usually obtained.

Ordinarily, when X ray apparatus is purchased from a reputable concern, instructions for setting it up and operating it should be furnished, especially if the apparatus is of an unusual capacity. Inasmuch, however, as X ray experiments may be made with a class of exciting apparatus that has been standard for many years and as a great many persons already have apparatus of this kind it may be of some assistance to show how such apparatus can be connected with the electric lighting circuit.

The diagrams Figs. 35 and 36 will show how this may be done. It will be noted in Fig. 35 that one conductor from the mains of the electric light circuit is connected to one of the primary

coil terminals. In a branch from the other main is placed a rheostat or a bank of lamps for resistance, the contact breaker being placed between the resistance and the other primary terminal.

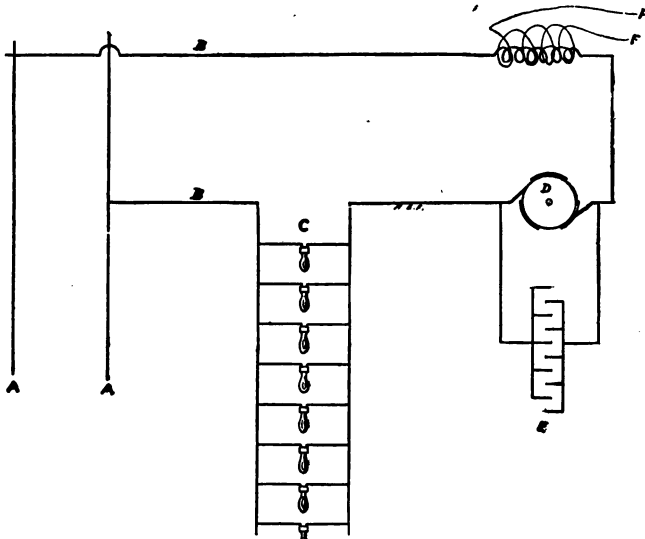

FIG. 35.

AA, Main line; BB, Branch line; C, Bank of lamps; D, Rotary contact breaker; E, Condenser; FF, Terminals of secondary coil.

It will be seen that the condenser is in shunt around the circuit breaker.

In the diagram, Fig. 36, the same general arrangement is shown except that a set of storage

batteries is arranged across the circuit. This need not be the regular form of storage battery, but each cell may consist simply of two lead plates immersed in a solution of one part of sulphuric acid to ten parts of water. Of course the lead plates in each cell should be kept separate from each other and all of the cells connected in series, as shown in the diagram.

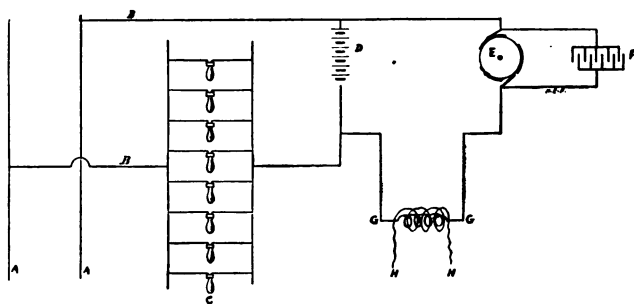

FIG. 36.

AA, Main lines; BB, GG, Branch lines; C, Bank of lamps; D, Storage cells; E, Rotary contact breaker; F, Condenser; HH, Terminals of secondary coil.

In operating an induction coil upon the electric light circuit according to the methods shown by the diagrams, the amount of electrical energy supplied to the coil may be regulated by the rheostat or by the number of lamps allowed to burn in the bank of lamps used for resistance.

Every lamp connected will of course allow more current to flow to the coil.

In using a new vacuum tube, it is advisable to keep down the amount of current flowing through the primary coil so as to bring the tube gradually up to its full capacity. This is especially the case if the type of tube used is *not* one of the focussing kind. Many a tube is spoiled by discharging through it when it is first used the full capacity of the coil when excited with the maximum current upon which it is used.

Frequently a new Crookes tube will show a very light blue cloudiness around the electrodes, and this should be worked out gradually by first operating the tube only with a small current. While it is best to do this either with focussing or non-focussing Crookes tubes, it is not so necessary with the focus tube as it is with the others.

The method of taking radiographs or making visual examinations with the fluoroscope in connection with high frequency apparatus or with Holtz or Wimshurst static machines is practically the same as when these operations are performed in connection with induction coils. That is to say, the tube is placed in the stand, and when the X rays are generated examinations

may be made with the fluoroscope, or radiographs may be taken in the same general manner as described above. The remarks already made in regard to the time of exposure and the distance

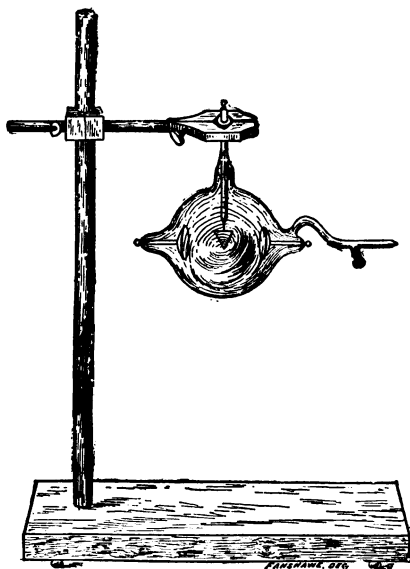

FIG. 37.

Crookes tube in adjustable stand.

of the tube from the object are, in the main, applicable also when these other types of exciting apparatus are used.

Supplementing what has already been said in



regard to distance and time of exposure, we desire it to be understood that the examples given are only intended to be approximate. These points can only be definitely settled by the operator after several trials. It is impossible to specify the exact time and distance requisite in any particular case unless the density of the object, and the degree of perfection of apparatus and the strength and abundance of the X rays are known. It will be apparent, therefore, that the above remarks on these points are intended merely as a sort of starting-point and some degree of guidance for the operator. A very short experience and practical use of X ray apparatus will serve as guide in determining the conditions necessary to obtain the best effects.

It is scarcely possible to give any specific directions as to the care and handling of static machines and high frequency apparatus, as they differ in their arrangement and construction as made by the various manufacturers. All reputable makers furnish with their machines the necessary instructions for their proper care and operation, and, as these are founded upon experience with their own apparatus, the purchaser will usually be able to obtain good results by the exercise of intelligent care and attention.

We believe that the amateur experimenter will have little trouble in obtaining satisfactory radiographs and fluoroscopic work with any good type of exciting apparatus upon following the hints contained in this chapter.

## CHAPTER XIII.

## PRACTICAL SUGGESTIONS.

THE readers of this book will probably be of two classes, namely, those who are merely seeking for general information on the subject of X rays, and those who are desirous of either experimenting, investigating or making practical use of the results. The contents of this chapter are intended to be of some practical use to the latter of these two classes of persons.

Beginning with the amateur experimenter who may already possess some one or more of the small types of apparatus that can be used in these investigations, let us see how far he may be able to go. There are many thousands of amateur experimenters who already possess induction coils and static machines that are capable of furnishing sparks of at least one inch in length. From the items that have appeared in the newspapers from time to time it might be thought that such modest apparatus would be of insuffi-

cient power to produce any satisfactory results in experiments with the X rays. It is our privilege, however, to be able to offer more encouragement to the possessors of apparatus of this kind.

While it is, as a matter of fact, possible to obtain some results with exciting apparatus giving less than one inch spark, the use of such small apparatus cannot be confidently recommended to the experimenter. The possessor of an induction coil or static machine, either Holtz or Wimshurst, giving sparks of one inch and upwards, can, however, make many interesting investigations and experiments therewith in connection with a small single focus tube.

Should the reader desire to make these experiments with an induction coil giving a one-inch spark, it is suggested that either one or two cells of storage battery or of a good primary battery, such as the Grenet, Bunsen, Fuller or Grove, or four cells of Edison-Lalande battery, be used to actuate the induction coil. The Leclanché cell is scarcely suitable for use with an induction coil for X ray work. Gravity cells may be employed, but in this case it would be necessary to connect from six to twelve of them

in two multiple series of three each for an induction coil of this size.

A single focus tube is by all means the best type of Crookes tube to be used in connection with a small induction coil or static machine, as the stream of cathodic rays can be concentrated and brought to a focus in the tube, and, proceeding in straight lines from the point of focus, will ensure sharply defined outlines of the opaque objects examined under the fluoroscope or laid upon a sensitized photographic plate. A specially designed single focus tube for small coils is made by some of the manufacturers and can readily be obtained at a moderate price.

With a small induction coil or static machine of the kind above indicated and one of these single focus tubes, together with a fluoroscope or fluorescence screen and some ordinary photographic plates, the experimenter is equipped for making observations and radiographs by means of the X rays. With such a set of apparatus, the whole cost of which is quite modest, very fair radiographs of small objects can be made and fairly good results can be obtained with the fluoroscope.

It will be found that with apparatus of this kind, radiographs of objects can be made through

several thicknesses of wood, or heavy millboard. Of course, the time of exposure would necessarily be a little longer than if a larger coil or static machine were used.

It will be quite apparent, therefore, that if an induction coil giving an inch spark can be successfully used, coils giving a greater length of spark may naturally be expected to produce correspondingly better results. There are very many persons possessing induction coils of what may be stated as of medium capacity, such as for instance those giving in the neighborhood of two or three inch sparks, who are still uncertain whether or not they can make experiments with X rays by means of these coils.

It is quite important in such work to use a battery which has a good output in amperes. The storage battery is an ideal one in this respect, but these are not always convenient on account of the necessity of recharging them from some source of direct current. Next in desirability is the primary battery known as the Edison-Lalande cell, which has a very large ampere capacity and almost no polarization when it is not in use. The electro-motive force of this cell is comparatively low, however, being only about seventenths of a volt per cell, while the storage bat-

tery, the Grenet, Bunsen, Grove and Fuller cells give in the neighborhood of two volts per cell. Although the use of the Edison-Lalande cell would necessitate the employment of a larger number, it is certainly the choice as between the various kinds of primary batteries for the class of work under consideration.

It will generally be found sufficient for induction coils giving sparks of from one to two inches to connect two cells of storage battery or six cells of the Edison-Lalande battery to obtain the proper working capacity of the coil. If any of the other types of primary battery are used, it depends on the size of the cell as to how many would be required to get the same effect. A single cell Grenet, Bunsen, Grove or Fuller Battery of the size contained in a one-gallon jar would give practically as good results as one medium size cell of storage battery, but if smaller cups of primary battery were used it would be advisable for the experimenter to have more than one set of cells on hand so that two or more can be connected in multiple to obtain the aggregate amperes of the cells so connected. For an induction coil giving three or four inch sparks, it would be advisable to double the battery capacity which we have just now stated for the small

coil, or, at any rate, to have them connected ready to be thrown in circuit if necessary.

The fortunate possessor of a static machine is not troubled with the questions of battery, as the source of the electricity is then within the machine itself and brought up to its maximum by the revolution of the plates. The proper excitation of the small focus tube with a moderate size static machine is a very simple operation as there are no batteries to be cared for.

All static machines are alike in this respect, namely, that they contain within themselves the source of their own current, and whether the machine be large or small, it only depends upon the operator to provide for some means of revolving the plates. In the larger sizes of static machines, a small motor of some kind is an exceedingly desirable adjunct, as the plates are revolved thereby with greater regularity and less labor than they can possibly be operated by hand.

So far as the results are concerned, as between static machines and apparatus of the induction coil type, it is doubtful whether there is any choice for one who is providing himself with a set of apparatus for X ray work. Equally good results can be obtained, under proper conditions,



with either class of apparatus of about the same degree of power in spark discharge capacity. The choice of the type of apparatus is very largely a question of individual preference, having due regard to the conditions under which the buyer expects to operate it.

Taking up for consideration the necessities of those who desire to make more extensive and elaborate investigations of the X ray phenomena and to make practical use thereof, we find that induction coils of larger sparking capacity will be required if that is the class of apparatus decided upon. A good size of coil for such purposes is one that will give about five or six inch sparks of good quality, in fact as we have before stated, a fat, heavy spark is far more desirable for this work than a long, thin, lean spark, although some results can be obtained from a spark of the latter quality. For the use of the physician or surgeon, an induction coil or apparatus giving about this length of spark will be found to be most generally useful for nearly all purposes, especially if a Crookes tube of good design and high efficiency be used in connection therewith.

We are again confronted here, however, with the question of individual preference, governed

by the existing conditions surrounding the contemplating purchaser of apparatus. As stated above, an exciting apparatus having a spark of about five or six inches is sufficient for almost all kinds of X ray work. There are several types of exciting apparatus obtainable giving this size of spark. One is the Induction Coil, another is the Static Machine, and a third is the High Frequency apparatus for use on an alternating current.

To operate the apparatus it is necessary, in the case of induction coils, to have either batteries or current from an electric light circuit supplying direct current. The static machine can be operated either by hand or a small motor, deriving its power either from electricity, gas or water, while the high frequency, or transformer, apparatus can be operated only from an alternating current circuit.

Assuming that the spark length of each of the above named three classes of apparatus is about equal, it should be noted that the high frequency apparatus is the most powerful of either of these three types. If, therefore, a physician or other person contemplating the purchase of apparatus is so situated as to be convenient to an alternating current circuit, the writer recommends the

adoption of exciting apparatus of the transformer type.

It is highly efficient for the purpose, requires but few accessories and may be connected direct to the circuit, thus avoiding the use of batteries.

Should there be no alternating current circuit available, the choice will necessarily be between an induction coil and a static machine. We have already pointed out that the former can be operated either directly from an electric light circuit, or with a few cells of storage battery, or a combination of both, while a static machine may be operated either by hand or by means of a small motor. When either type of apparatus is once set up and ready for operation there is but little difference in the amount of manipulation required to operate either one of them. Of the two the static machine requires, perhaps, the least number of accessories for its operation and produces very sharply defined radiographs. The induction coil, on the other hand, is generally regarded as being more flexible in the variations which can be obtained from it, and it is, if anything, less delicate in construction and arrangement and perhaps is an apparatus that will stand more years of constant usage.

As we have stated above, it is, however, largely

a matter of individual preference, and if the reader should choose either type of apparatus of the capacity in question and purchase it from a reliable manufacturer, he may rely on being able to produce satisfactory results if he operates it with judgment and discretion.

If it is desired to do the very highest kinds of X ray work, it may be advisable at the outset to invest in a larger induction coil or static machine. These are made commercially to give from 8 to 12 inch sparks, and may be operated in the same way as the smaller ones, but requiring increased power, of course. Apparatus of still larger sparking capacity can also be obtained, but thus far it has not been necessary to employ any giving sparks of greater than 12 inches in length for the highest X ray effects.

## CHAPTER XIV.

### PHOTOGRAPHIC PLATES AND DEVELOPERS.

THE art of photography is so well understood in these days that it seems almost superfluous to offer any suggestions on this line. As experiments with X rays will, however, in many cases, be made by those who have had no experience whatever in the art of photography, we shall venture to offer a few suggestions to the reader who may never have handled or developed a photographic plate.

To take a radiograph by means of the X rays, a sensitized photographic plate is, of course, a necessity. These are obtainable in almost any city or town. The first necessity is to have a dark room and the next a *ruby* light. Lanterns with ruby glass panes can be bought at any photographic supply store. An undeveloped photographic plate should never be exposed to any but a ruby light.

Let us suppose that the experimenter has pro-

vided himself with a package of plates and a ruby light. He should go into a perfectly dark room, light the lantern and close its opening. The box of plates may then be opened. A plate is taken out and should be either placed in a regular plate-holder, or wrapped up in photographer's black paper, or placed in a cardboard box.

A photographic plate has upon one side of it a hard, white, sensitized gelatine film. The film side can always be ascertained by holding the plate sideways towards the red light. The film side is dull while the other side of the plate, being plain glass, has a bright and shining appearance. If still in doubt, the film side can be detected by moistening a finger and touching one corner of the plate. If the film is on that side, it will feel sticky.

In placing a plate in the holder or any other covering, great care should be taken that the film side is uppermost, as it is desirable to *have the film as near as possible to the object to be radiographed*. The box of plates should be closed again and the operator is ready to take the radiograph.

If the plate is placed in a cardboard box, the box should be filled up with several papers or a

few corks so as to insure the film being near the upper surface of the box.

It is not necessary to open the plate-holder or other covering of the plate to make the exposure, as it can be made through the cover of the plate-holder or through the envelope covering the plate. In purchasing a plate-holder one should be selected with a sliding cover that is *not* made of *metal*.

The exposure having been made, the next thing in order is to develop the plate. To do this and fix the image, two things are necessary: one a *developing solution* and the other a solution of *hyposulphite of soda*. The latter solution is for the purpose of fixing the image upon the plate after development.

Two trays to hold the solutions are necessary, one for the developer and one for the hyposulphite of soda. Neither of these trays should ever be used for any other solution than the kind first put in it. Single solution developers can be purchased of all dealers in photographic materials, who also sell the hyposulphite of soda. The latter article is in a crystal, and must be dissolved in water, according to the formula which will be found enclosed in any box of plates.

It will be seen, therefore, that only two bot-

tles will be necessary, one a developing solution and the other a solution of hyposulphite of soda. We will now suppose that the operator is ready to develop the picture.

A small portion of the developing solution is mixed with cold water, according to the directions usually found on the bottle. This diluted solution is poured into a tray and the plate placed in it, *film side up*. This is all done in the ruby light, of course. The tray is gently rocked from side to side for a few minutes and the image will slowly appear. The plate should be kept in the solution until it (the plate) has become quite dark, and until the image has apparently almost disappeared. It should then be taken out and washed in clean water and then put into the other tray containing the solution of hyposulphite of soda.

At this time the plate, at the back, is of a light color, almost the same as it originally had, but after being in the solution of hyposulphite of soda for five or ten minutes this will disappear and the plate will look black. The picture is then developed and fixed, and may be taken out into the light, but before being set up to dry should be washed for about half an hour in running water, or if that is not available it should be washed in



clean cold water for about the same length of time, the water being changed very frequently. *Cold* water should be used throughout.

The operation is less formidable than it might appear from reading the above. After a few pictures have been taken it will be found that a radiograph can be made, developed and fixed in fifteen or twenty minutes. If the reader has not had any previous photographic experience, he is recommended not to try an important picture as his first radiograph, but to experiment a little before proceeding to that class of work. It is exceedingly simple primarily, but, of course, pictures of a high degree of excellence are only obtained by experience.

The best kind of photographic plates for X ray work are those which have a heavy coating of film. These are specially made for this work by some of the well known manufacturers. Any good developer may be used, but for general work, and especially for amateurs, "Metol" developer is strongly recommended and has been used by the writer with considerable success. The developer put up in dry form by J. Carbutt of Philadelphia, and known as the "J. C. Tabloids," has also been much recommended by many

persons who have made large numbers of radiographs.

For the convenience of the reader it is also suggested that the same concern furnishes specially prepared photographic plates for X ray work, each plate wrapped separately and sealed in black paper. These are known as Carbutts' X ray plates and may be obtained from regular dealers.

# INDEX.

## A.

	PAGE.
Accumulator (Condenser).....	66
Adjustable Vacuum Crookes tubes.....	127
Air blast (High Frequency apparatus).....	85
Alternating current apparatus.....	74
"    "    "    Action of.....	81
Alternations of current.. .. .	76
Apparatus for producing X Rays.....	15-29
Armature—vibrating.....	45
Attraction and repulsion.....	91

## B.

Batteries.....	144, 170, 173
Bound electricity.....	93

## C.

Coils. See induction coils.	
Condenser.....	53, 66
"    action of.....	72
Contact breaker.....	45, 52, 60, 157
"    "    Essentials of.....	61
"    "    Rotary.....	62
Connections of double-focus tube.....	122
Crookes tube.....	17, 106
"    "    On electric light circuit.....	29
"    "    Qualities of exciting current....	29
"    "    Edison pattern.....	116

	PAGE.
Crookes tube, Thomson pattern.....	119
“ “ Double-focus.....	120
“ “ Single-focus.....	124
“ “ Adjustable vacuum.....	127
“ “ Loss of vacuum.....	160
Core for induction coil.....	48
Current, direction of.....	36
“ source of.....	136
Cycles.....	77

**D.**

Definition.....	88
Developing a photographic plate.....	181
Developers, photographic.....	183
Discharger.....	71
Discovery, time of Prof. Roentgen's.....	10

**E.**

Edison Crookes tubes.....	116
Electric light circuits, connections with.....	163
Electrical energy for Crookes tube.....	31
Electromagnetic current induction... ..	39
Electrophorus.....	94
Exciting apparatus.....	29
“ “ Means for operating.....	137

**F.**

Fluorescence.....	25
Fluoroscope.....	26, 129
Fluorescent screen.....	27, 131
Fluorescence of Crookes tubes.....	109
Fluorescing crystals.....	130
Fluoroscope, use of.....	132

# *Index.*

187

	PAGE.
Focusing Crookes tubes.....	119
Thomson double-focus.....	120
Single-focus.....	124
Frequency.....	77
Free electricity... ..	93

## **G.**

Gas cells.....	164
Geissler tubes.....	107

## **H.**

High Frequency apparatus.....	74
“    “    “    Means of operating.....	139
Holtz Static Machine.....	98

## **I.**

Induction coil, character of sparks.....	15
Induction, theory and philosophy.....	34
Inductive effects.....	40
Induction, self.....	42
Induction coils.....	47
“    “    Core for.....	48
“    “    Primary coil.....	49
“    “    Secondary coil.....	50
“    “    Contact breaker.....	52
“    “    Condenser.....	53
“    “    Pole changer.....	54
“    “    Late improvements in.....	56
“    “    Insulation, oil.....	58
“    “    Current for operating.....	141

## **L.**

Leyden Jar.....	70
Light rays, refraction of.....	14
Lines of force.....	36

	PAGE.
<b>M.</b>	
Magnetic field.....	35, 37
Manipulation.....	146
Mechanical contact breaker.....	61
<b>O.</b>	
Oil insulation for coils.....	58
<b>P.</b>	
Penetration of the X rays.....	23
Photograph.....	20
Photographic plates and developers.....	179
Pole changer for induction coil.....	54
Practical suggestions.....	169
Pressure of induced currents.....	43
Primary coil.....	49
Primary wire.....	41
<b>R.</b>	
Radiograph.....	20
"    making a.....	149
"    time of exposure.....	151, 155
Regulator for High Frequency apparatus.....	86
Repulsion of similarly electrified bodies.....	91
Rotary contact breaker.....	61
Ruhmkorff coil. See induction coils	
"    "    Current for operating.....	141
"    "    Character of sparks.....	15
<b>S.</b>	
Secondary wire.....	41
Self induction.....	42
Secondary coil.....	49
Source of current.....	136
Spark length.....	44

# Index.

189

	PAGE.
Spark gap (High Frequency apparatus).....	84
Spark gap.....	152
Static Machines.....	90
"    "    Holtz.....	96
"    "    "    Action of.....	99
"    "    Wimshurst.....	104
"    "    Means of operating.....	138
Storage batteries for operating coils.....	143
Suggestions, practical....	169

## T.

Transformers—High Frequency.....	74
"    "    "    operation.....	139
Troubles with apparatus.....	159
Tubes low vacuum.....	16
"    Crookes.....	17, 106
"    Geissler.....	107
"    Edison.....	116
"    Thomson.....	119
"    "    double-focus.....	120
"    Single-focus.....	124

## V.

Vacuum, adjustment of in Crookes tubes.....	127
"    Degree of in    "    ".....	108
"    Rise of in    "    ".....	125
Vibrating contact breaker....	45

## X.

X Rays, ascertaining presence of.....	18
"    Effect of on sensitized plate.....	22
"    Generation of.....	12, 17
"    Penetration of.....	23





