

MANUAL OF APPAREL DRAFTING AND SEWING

By Mattie G. Kunz

U. S. CIVIL SERVICE, ELIGIBLE IN 1902,
AND RECEIVED OFFER OF APPOINT-
MENT TO A SEWING TEACHER POSI-
TION IN THE U. S. INDIAN SERVICE

REVISED EDITION

Price 60 Cents

MRS. MATTIE G. KUNZ, PUBLISHER
WASHINGTON, D. C.

PRESS OF J. D. MILANS & SONS
WASHINGTON, D. C.



✓ MANUAL OF APPAREL DRAFTING AND SEWING

By Mattie G. Kunz ✓

U. S. CIVIL SERVICE ELIGIBLE IN 1902,
AND RECEIVED OFFER OF APPOINT-
MENT TO A SEWING TEACHER POSI-
TION IN THE U. S. INDIAN SERVICE

✓ REVISED EDITION ✓

Price 60 Cents

MRS. MATTIE G. KUNZ, PUBLISHER
WASHINGTON, D. C.

PRESS OF J. D. MILANS & SONS
WASHINGTON, D. C.

T7751E
-K8

COPYRIGHT, 1913
BY MATTIE G. KUNZ

REVISED EDITION
COPYRIGHT, 1914
BY MATTIE G. KUNZ



DEC 31 1974

©GLA392105

kor

R

15-5470

Preface

This book is submitted for publication with the confidence that it will not only favorably compare with but excel all previous systems of garment drafting, because of its simplicity, which is its best recommendation. It will be found that it has not the multiplicity of numbered lines and lettered dots of other systems. The figures shown on the herein embodied diagrams simply represent actual measurements of work, and one understands what the lines stand for by their position and order of measurements.

This is an age of great factory power, and with electric machinery our ready-made clothing is representative of a high type of perfection and civilization; nevertheless, individual effort should be encouraged and maintained, in order to obtain the beneficial results in our homes and in our schools. In our homes many physicians are advocating the good of this kind of training, explaining that the anatomy of growing children demands well measured and comfortably made clothing, and for their delicate female patients, knitting and embroidery are often prescribed, with the suggestion that in tranquilizing the spirit the body will invariably respond.

After learning this garment drafting course, one can dispense with the experience of having to serve as an apprentice in a tailoring establishment where there is often observable among avaricious proprietors an air of unrefinement and where there is much repetition of the same task to be performed.

In illustrating this method of drafting with a series of implements, it will be found that one can derive better and more satisfactory results for the sewing preparation by adopting the miniature method of drafting, which has the $\frac{1}{4}$ inch as its basis, and hereinafter more fully described.

To prepare for the sewing vocation one should provide the following tools of trade: First are the drafting implements made of cardboard and inclosed in the back of this book. Get a little book for a "measure book" (see sample measure book in the back of this book), a table, a chair, a thimble, different sizes of needles, different numbers of thread, a tracing wheel, scissors, a tape-measure, a tailor's iron, a plain and a curved pressing-board, and from 2 to 3 yards of plain white cotton. It is obvious that tailoring cannot be done without the right kind of cloth. Thus by using one of the small size implement processes to obtain a pattern (or to work the solution out for the full size pattern), time, space, and material is saved, and the proper quality and quantity of material can be afforded, and should be procured for teaching purposes.

MATTIE G. KUNZ,
Washington, D. C.

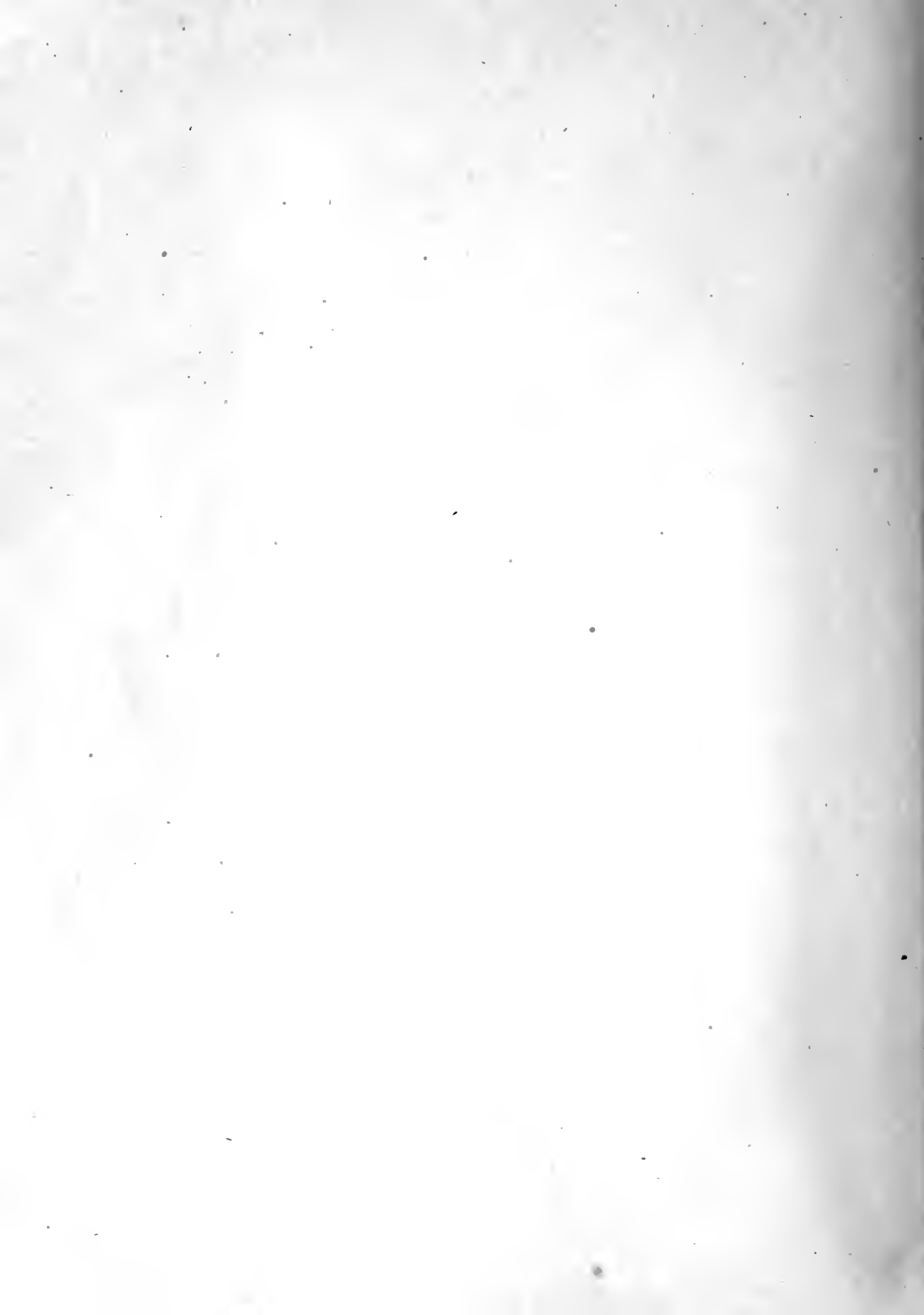

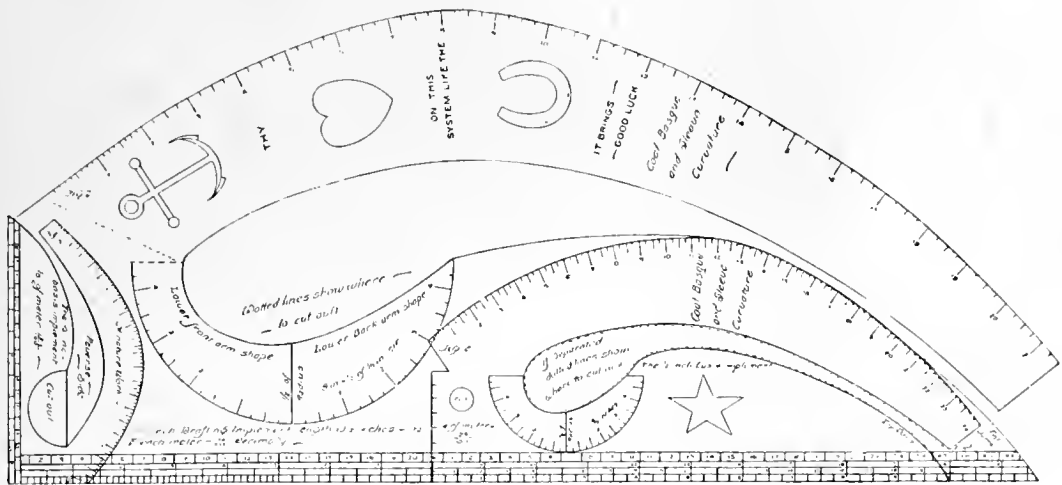

In this manual of apparel drafting and sewing there is set forth an original order of measurements, and a series of drafting implements are used. The drafting is developed along arithmetical lines, and when understood, the ability to draft all kinds of patterns both plain and fashionable will follow naturally. The number of measurements taken for all forms is shown by the "Order of Measurements" given, and the manner of taking them is learned from a study of the diagram.

The series of drafting implements with large size curvature pattern are inclosed in the back of this book, and are described as follows: The first size implement, which was used to draft the diagrams in this book, represents the $\frac{1}{4}$ inch for the inch, the second size implement represents the $\frac{1}{2}$ inch for the inch, and the third size implement represents the full inch. An ordinary ruler, however, takes the place of the third size implement, but the curvature is used. Curves may also be drawn by free-hand drawing.

One advantage this system of garment cutting offers is that one can sit at a table, draft the small pattern, make the arithmetical solutions, and when finished copy it to produce the large size pattern by using the full inch basis implement, as the figures on the small pattern work represent full inches. The $\frac{1}{2}$ inch basis implement makes a larger drafting than the $\frac{1}{4}$ inch basis implement, and one may prefer to first study with the $\frac{1}{2}$ inch basis implement. The $\frac{1}{4}$ inch basis implement has been used for this book work, because it produced the best size pattern for a book.

After drafting a pattern by any of the three processes, first see that the pattern is used upon the lining of the goods. In drafting make no allowance for seams, but after tracing off each part of the pattern allow $\frac{1}{2}$ an inch for all seams except at neck and arm-hole. Adopt some symbol on the pattern in which the desired thread or weave of the goods in the garment should fall. For instance, make a long straight mark thus — for the lengthwise of the goods, and a cross mark thus X for the crosswise of the goods. Mark an equal number of notches where seams are to be joined; mark N. S. (no seam) where the goods should be folded and no seam made. Mark an independent zigzag line where the goods should be gathered. These abbreviations will be of great benefit when joining the different parts of the pattern together.

An easy way to draft a basque pattern which is to be cut out first upon the lining of the goods, tried on, and fitted about the arm-hole. The measurements for each form are different, but the order of measurements for all forms is as follows:

Order of Measurements.

Basque.	1. Length of back.....	15½ inches
	2. Under- arm	7 "
	3. Bust	38 "
	4. Neck	14 "
	5. Width of back.....	14 "
	6. Shoulder in length.....	6 "
	7. Waist	27½ "
	8. Entire front measure.....	15 "
	9. Width of chest.....	14½ "
	10. Shoulder line	8 "
	11. Shoulder point	9 "
	12. Front test measure.....	19 2/3 "
	13. Around the form over the hips.....	42 "

First study diagram.

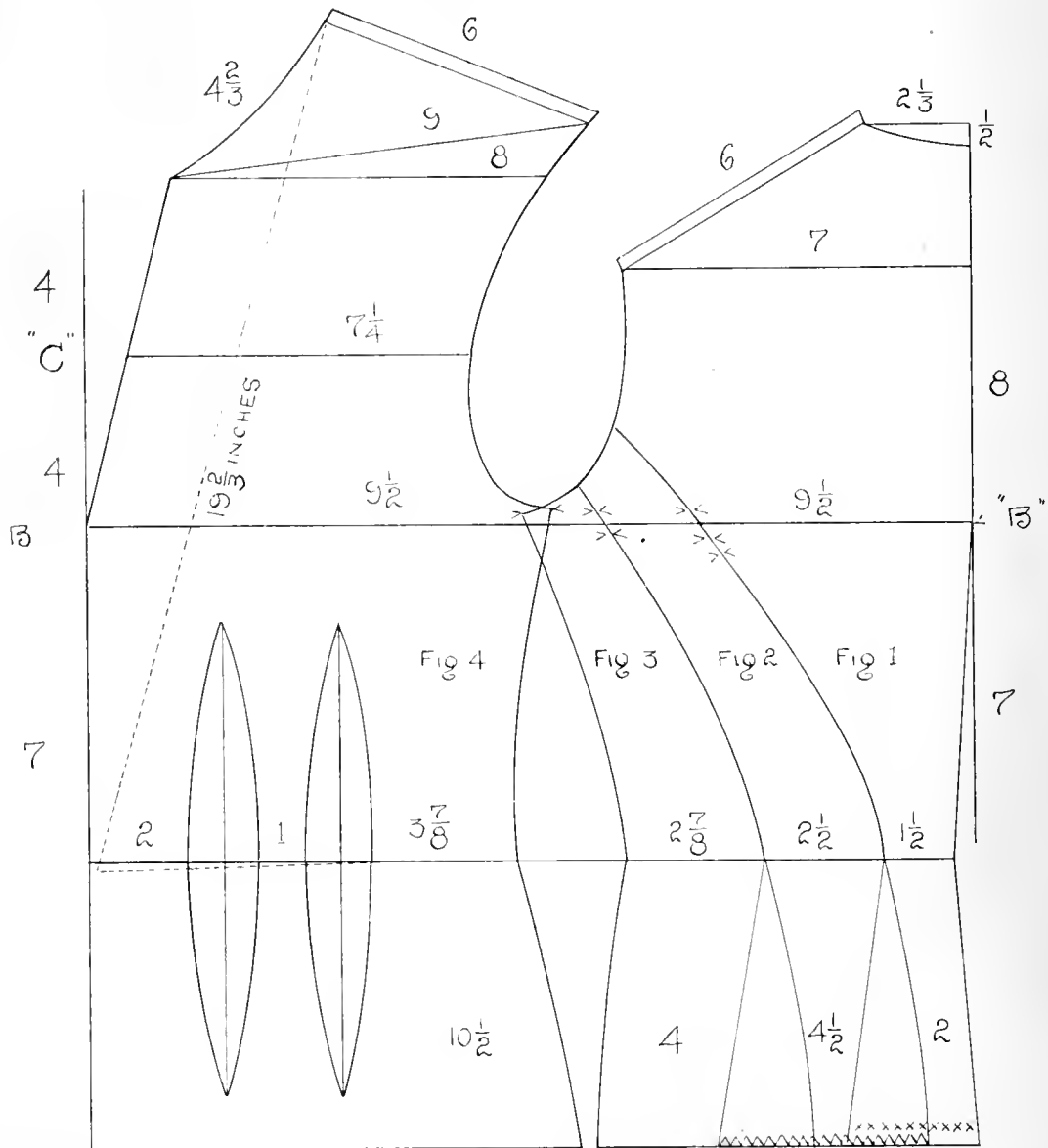

In illustration of the $\frac{1}{4}$ inch basis implement process, if the back length measure is $15\frac{1}{2}$ inches, then $\frac{1}{4}$ of $15\frac{1}{2}$ inches equals $3\frac{7}{8}$ actual inches for the back length measure and the starting of this very small diagram.

When using the $\frac{1}{2}$ inch basis implement process; if the back length measure is $15\frac{1}{2}$ inches, then $\frac{1}{2}$ of $15\frac{1}{2}$ inches is $7\frac{3}{4}$ actual inches for the back measure.

To make a practical pattern of the human form, use the full inch process, the work of which is done with the ordinary ruler, and the large size curvature, or free hand drawing. The second size curvature will sometimes make a prettier curve for this process; if so, then make use of it.

Now for a measurement coming in circular, like bust measure, take $\frac{1}{4}$ of whatever the bust measure is; it is 38 inches in this instance; $\frac{1}{4}$ of 38 inches equals $9\frac{1}{2}$ inches, as is shown on diagram.

The formula for drafting the easy way to make the basque by any of the three processes is as follows:

Now get a piece of plain white or Manila paper; start the drawing about 4 inches from the top surface and also 4 inches from the bottom surface.

Draw a perpendicular line the "length of back measure" from the belt line to the top of neck. It is $15\frac{1}{2}$ inches in this illustration, and $\frac{1}{2}$ an inch of this measure is used for neck curve. Having drawn this line, dot from the bottom on the same at a point the "length of under-arm measure," which is 7 inches, and mark it "B" for bust line. Now draw a horizontal line out leftward from this dot "B" the desired back bust line, making it $\frac{1}{4}$ of the entire bust measure. One-fourth of 38 is $9\frac{1}{2}$ inches.

Next draw a horizontal line from top of neck leftward one-sixth of entire neck measure. Always as a rule divide the neck measure into six equal portions, the back portion counting for $\frac{2}{6}$ and the front portion counting for $\frac{4}{6}$. Divide this by 2 in order to draft this work on paper. $\frac{1}{2}$ of $\frac{2}{6}$ is $\frac{1}{6}$. $\frac{1}{2}$ of $\frac{4}{6}$ is $\frac{2}{6}$; therefore, if the neck measure is 14 inches, $\frac{1}{6}$ of 14 inches is $2\frac{1}{3}$ inches, for the back neck portion. If $\frac{1}{6}$ equals $2\frac{1}{3}$ inches, $\frac{2}{6}$ is twice $2\frac{1}{3}$ inches, which is $4\frac{2}{3}$ inches, to be used for the front neck portion. Now draw this $2\frac{1}{3}$ inches for the back neck portion. Next draw from top of neck the "shoulder in length," which is 6 inches, sloping it to connect with the "back width measure," which is 7 inches, or $\frac{1}{2}$ of the entire back measure, but first use two implements to adjust these measurements to get their required position and then draw the "shoulder in length" 6 inches to meet the "back width measure," which is a 7-inch horizontal line, and begins at first perpendicular line.

Next curve down from left end of "shoulder in length" to within an inch or so above the end of $\frac{1}{4}$ of entire bust measure. Now draw the waist to this back the number of inches desired. The waist measure is $27\frac{1}{2}$ inches; $\frac{1}{2}$ of $27\frac{1}{2}$ inches, in order to draft on paper, is $13\frac{3}{4}$ inches, and $\frac{1}{2}$ of $13\frac{3}{4}$ inches is $6\frac{7}{8}$ inches, for waist portion. On the entire one-half waist line there are six parts to be considered, namely, the small back, the side-back, the under-arm, the side-front, and the front with its dart spaces. Proportion on the $\frac{1}{4}$ waist measure already drawn—the $6\frac{7}{8}$ inch line—the small back, the side back, and the under-arm portion, as desired. In this instance we will proportion the small back two inches from first perpendicular line, allowing $\frac{1}{2}$ an inch for body-bearings, the side-back $2\frac{1}{2}$ inches from small-back, and the under-arm $2\frac{7}{8}$ inches from side-back. Having dotted on waist line for each portion, commence at arm-slope and curve down a proportional width to connect at dots on waist line, using curvature on implement, and preserving a somewhat uniform proportion from top to bottom. Mark these portions Figures 1, 2, and 3, as shown on diagram.

Next commence at end of $\frac{1}{4}$ of bust measure, and draw out leftward a horizontal line the remaining distance of the bust measure, which is $9\frac{1}{2}$ inches in this illustration, and mark the terminus "B" for bust line. Connect at "B" and draw up an 8 inch perpendicular line, as the lower measurement (below "B") is 7 inches, and these two amounts of 7 and 8 inches make 15 inches, the "entire front measure." Draw down from "B" a 7 inch perpendicular line. Next draw a "varying

line" 8 inches upwards (calling it varying line because it varies to meet the requirements of different sizes of front neck measures); in this instance, presume that it varies 2 inches from the perpendicular line, and if not correct, the "shoulder line," the "shoulder point," and the "neck measure" will show it, after these latter measurements are drawn by making the arm-hole size too narrow; then erase varying line and adjust it. (Do not draw the varying line too wide, as the arm-hole must not be too narrow. A reasonable size arm-hole is to be considered.) Then in every instance use the one-half distance of the upper portion from bust line to the top of neck for the "chest measure"; draw then half-way on the varying line a horizontal line the "length of chest measure," which is $7\frac{1}{4}$ inches in this illustration, and mark "C" for "chest measure" on the half distance of the upper portion from bust line to the top of neck.

Next measure up from the top of varying line for the "front neck curve measure," which in our previous neck calculation was found to be $4\ 2\ \frac{3}{8}$ inches, to connect with the "shoulder in length" measure, which is 6 inches, using two implements to obtain the proper adjustment; use curvature of implement to draw this $4\ 2\ \frac{3}{8}$ inch front neck measure; now draw the "front neck curve measure" $4\ 2\ \frac{3}{8}$ inches, and the "shoulder in length" 6 inches. Draw also the "shoulder line measure," which is an 8 inch horizontal line from top of varying line, and also draw from top of varying line the "shoulder point measure," which is a 9 inch diagonal line. Now draw out the front arm-curve, commencing at right end of "shoulder in length," to meet the back arm-curve. (Remember that the "shoulder line," "shoulder point," and "shoulder in length" are three separate order of measurements.)

Now commence at waist line at the under-arm portion, and draw waist line, drawing from line to line, forming any surplus inches over the waist measure into darts or body-bearings on this waist line. In this instance we will make two darts. Space off on this waist line for the side-front, which is $37\frac{8}{8}$ inches, and the front with its dart spaces of 1 and 2 inches each, as the darts in this instance are made 2 inches wide. The sum of the side-front portion and the front with the dart space portion make $67\frac{8}{8}$ inches, the remainder of the waist measure. Make the darts as high and as low as desired, and use curvature to shape them. This work is designated Figure 4 on diagram.

Below waist line curve out for Figures 1, 2, and 3, to make $\frac{1}{4}$ of hip measure, making the small-back portion 2 inches wide, the side-back portion $4\frac{1}{2}$ inches, and the under-arm portion 4 inches, making a total of $10\frac{1}{2}$ inches, which is $\frac{1}{4}$ of hip measure, and which plus Figure 4, with its $10\frac{1}{2}$ inches, makes 21 inches, or $\frac{1}{2}$ of hip measure, the entire hip measure being 42 inches. The "front test measure," which is $19\ 2\ \frac{3}{8}$ inches in this illustration, is indicated by a dotted line on diagram, and it determines whether the waist line already drawn should be raised or lowered. This measure commences at the highest point by the neck, or top of front neck curve measure, and extends to the waist line. In this instance $2\ \frac{3}{8}$ of an inch extension below the waist line is required.

Having finished drafting this basque, if convenient and found desirable, use a red and blue pencil to show distinctly where to run the tracing wheel in tracing off each part of the basque.

To make a plain Shirt-waist.

To convert the basque into a plain shirt-waist, lay Figures 1, 2, and 3 on one piece of paper, and make the outline for another pattern, eliminating all lines beneath. Lay Figure 4 on another piece of paper, eliminating the darts. Draw out two inches extra on the front or back measure for the hem for the opening to be made in either the front or back of the waist, as desired, no seam to be made in the back if the opening of the waist is to be made in the front, or vice versa. This will make a plain shirt-waist pattern. To make a large tuck on each shoulder or tucks in the yoke, tuck the goods as desired, place and pin this plain shirt-waist pattern over the goods, and cut out on the goods for another style of waist. The goods in each case is to be folded.

Suggestions regarding the drafting course.

It is suggested that one study the diagram and work of the easy basque pattern carefully, and then produce a pattern for the same order of measurements by the $\frac{1}{2}$ inch basis implement process and also by the full inch basis implement process before taking up the order of measurements to produce a pattern for another form by any of the three processes.

It is also suggested that a study of drafting alone be pursued for all of the patterns in this book until the drafting principles are thoroughly mastered before commencing the cutting of cloth and sewing. The use of paper only and not cloth and little pins for pinning the paper seams together is recommended for the initial preparation for this trade. Many young boys would perhaps like to study the drafting course to become pattern producers when they would not care to become cutters and sewers, and it is suggested that they be given a chance to learn the drafting course, if they so desire, in order that each student's aptitude for this trade may be ascertained.

The measurements for boys' and men's clothing are very much fewer than those for girls and women, and the measurements of boys' and men's clothing may be taken by the boys or girls and drafted after the drafting course in this book has been finished.

Suggestions for economy of cloth.

As a matter of economy, when the basque has been drafted by the full inch basis process, and cut out of plain white cotton, it is suggested that the basque be used as a fitted lining for a home blouse, and a home blouse is made by tucking the yoke part of the blouse cloth before fitting it to the basque cloth, eliminating in the blouse cloth the darts and back seams which are in the basque cloth, and joining together the blouse cloth and fitted basque cloth at the side under arm seams and shoulder seams. A box plait may also be formed in the center back of the blouse and be stitched only to the waist line, allowing the plait to be loose below the waist line. By using the basque as a fitted lining for a home blouse in this way the cloth of the basque is not wasted while at the same time the instruction in drafting is imparted.

The first skirt which has been made while learning the first principles of drafting may also be used as an undergarment.

Bust forms are of great advantage to the dressmaker. Regarding the making of a bust form see remarks under sewing suggestions in the advanced course. It is suggested that a bust form of one's own measurements, by the $\frac{1}{2}$ inch basis implement process, be made, as on this size bust form tailoring material may be used and could be afforded, and the art of pressing and buttonholing may be learned.

Sleeve Order of Measurements.

1. Take inside length of arm at front..... 18 inches
2. Top of arm, around it..... 15 "
3. From 2, 3 the way from inside length of arm measure on top of arm measure up to the end of shoulder point measure, as shown by the 5 inch dotted line on diagram..... 5 "
4. Elbow, around it..... 14 "
5. Wrist, around it..... 9 "

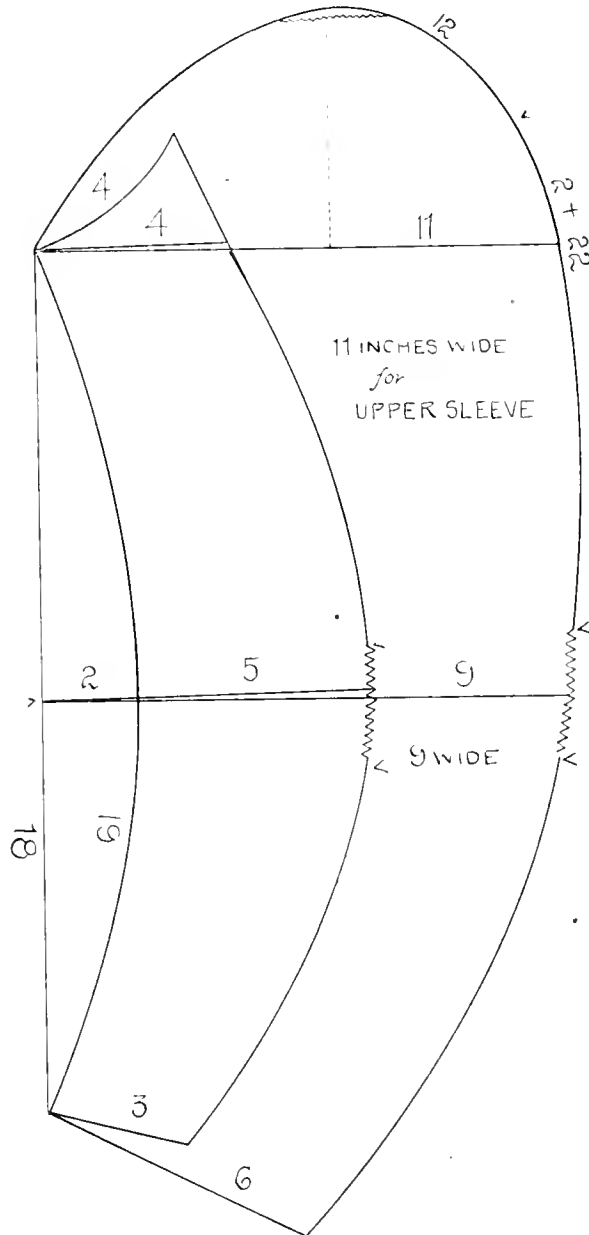

Sleeve Formula.

Draw a perpendicular line the "length of front inside arm measure," which is 18 inches. Bisect this perpendicular line, and draw a horizontal line 2 inches at center of sleeve in every instance. Draw a curve line commencing at the top of the 18 inch perpendicular line down to the end of the 2 inch line at center of sleeve just previously drawn, and continue down to the bottom of the 18 inch perpendicular line. This curve line will measure 19 inches. Now draw out from the top of perpendicular line a 4 inch horizontal line for the under sleeve portion of the top of arm measurement, the entire top of arm measurement being 15 inches, and the under sleeve portion always being drawn smaller, about $\frac{1}{3}$ of the width of the sleeve. Raise drafting implement 2 inches in every case and draw down a 4 inch curve line to correspond with the 4 inch under sleeve portion of the top of arm measurement line just drawn. Also connect at center portion of sleeve at 19 inch curve line and draw a 5 inch horizontal line for the under sleeve portion of the elbow measure, the entire elbow measure being 12 inches. Next draw out obtusely at bottom of wrist 3 inches for the under sleeve portion of the wrist measure, the entire wrist measure being 9 inches. Now draw a curve line measuring 22 inches to this under sleeve portion. Draw out at top of arm a horizontal line the balance of the top of arm measurement, which is 11 inches, beginning at the 18 inch perpendicular line. Draw out for the elbow a 9 inch horizontal line, which is the balance of the elbow measurement, beginning at the center of this 19 inch curve line. Draw out obtusely for the wrist a 6 inch line, which is the balance of the wrist measurement, beginning at the 18 inch perpendicular line. Now draw a curve line measuring 22 inches to this upper sleeve portion. To make a few gathers at the elbow, draw the 22 inch upper sleeve portion line 2 inches longer at the top, making the upper sleeve portion line 24 inches, and as the under sleeve portion line measures 22 inches, the difference between the under and upper sleeve portion lines is 2 inches for elbow gathers; and dot off on sleeve at elbow 2 inches and gather the 2 inch surplus of the upper sleeve portion to meet the under sleeve portion in joining these two portions together. Next draw the top of this sleeve, say a curve line measuring 12 inches, which plus the 4 inch curve line already drawn, makes 16 inches, the arm-hole measurement. If gathers are desired in the sleeve at the top, this 12 inch curve line must be drawn longer and the top of arm and elbow measurements drawn wider. The surplus inches at the top of arm over the arm-hole measurement is then gathered to meet the arm-hole measurement. When setting the sleeve in the waist be careful to start the front seam of sleeve about $\frac{1}{2}$ an inch below "chest measure" line. After basting in the sleeve, hold the garment up and observe if the sleeve hangs properly.

Skirt Order of Measurements.

1. Around the waist at belt line.....	27 $\frac{1}{2}$ inches
2. Around the hips.....	42 "
3. Down front the desired length.....	42 "
4. Down back the desired length.....	43 "
5. Down side over the hips.....	43 "

WAIST MEASURE
27½ INCHES

HIP

6 2/7
6 1/10

10½ INCHES WIDE

10½ INCHES WIDE

PLACKET

A STITCHED PLAIT

2 INCHES EXTRA FOR PLAIT

N.S. (NO SEAM) GOODS FOLDED

43 INCHES LONG

42 INCHES LONG N.S. (NO SEAM) GOODS FOLDED

43 INCHES LONG

18 INCHES WIDE

18 INCHES WIDE

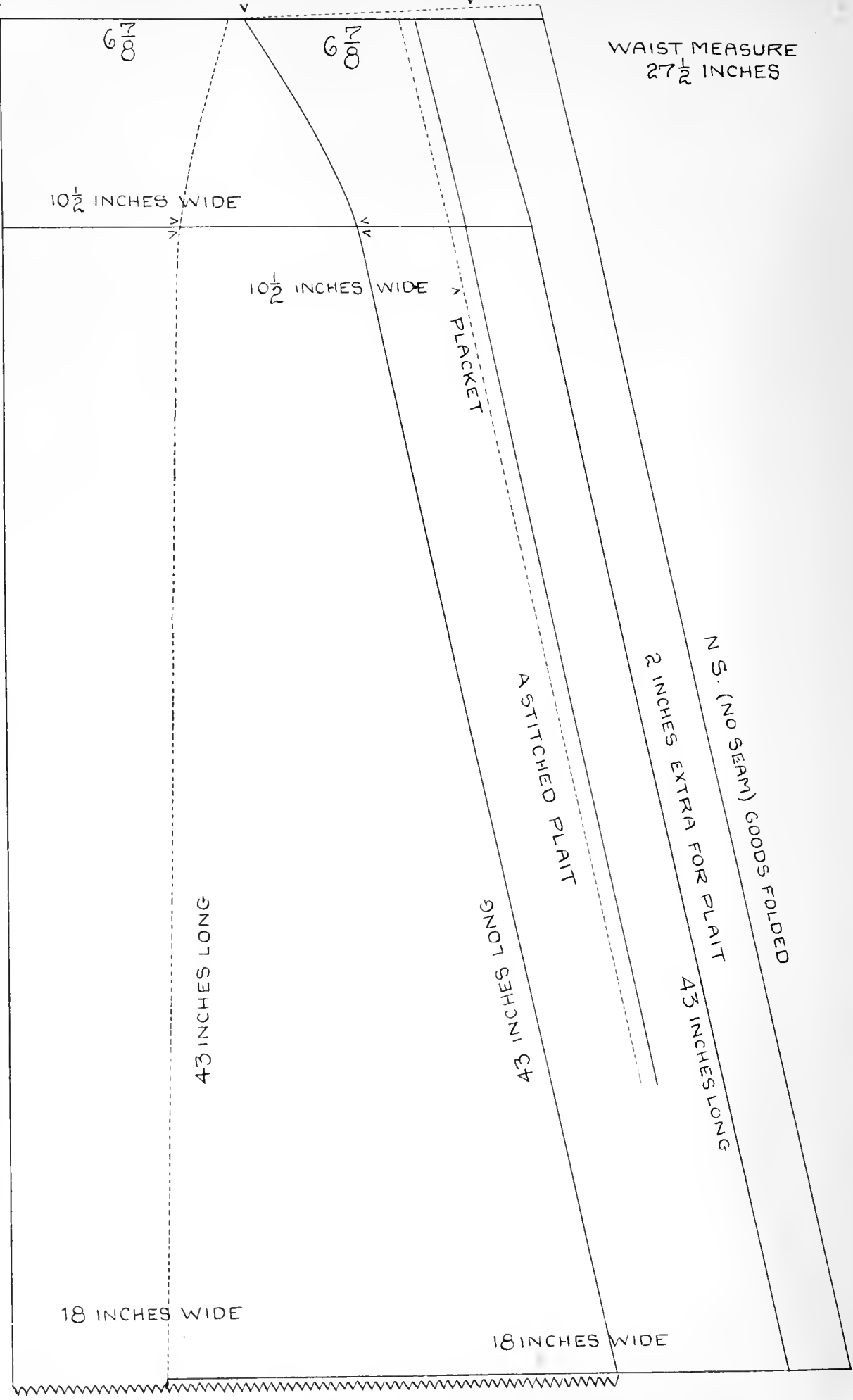

Formula for a Two-piece Skirt.

The waist measure in this instance is $27\frac{1}{2}$ inches. To draft on paper, use only one-half of waist measure, which is $13\frac{3}{4}$ inches. Draw this $13\frac{3}{4}$ inch horizontal line for waist line. Then connect at left terminus of this $13\frac{3}{4}$ inch line and draw a perpendicular line down the desired length of skirt measure, which in this instance is 42 inches. Now measure six inches down on this perpendicular line from the top (as the hip measure is taken six inches below the waist line around the body over the hips usually in adults, but the measurement is always taken over the fullest portion around the body over the hips on all forms), and draw out a $10\frac{1}{2}$ inch horizontal line of the hip measure (which is $\frac{1}{4}$ of entire hip measure, as it is to be a two-piece skirt), for the front portion of this skirt. Now draw a curve line commencing at a point $6\frac{7}{8}$ inches on waist line, which is $\frac{1}{2}$ of the $13\frac{3}{4}$ inch waist line, as it is to be a two-piece skirt, and curve down six inches to the $10\frac{1}{2}$ inch hip line measure previously drawn and continue down the remainder of the side-skirt measure, which is 43 inches, to a point at the bottom which measures 18 inches wide, the entire skirt being 2 yards wide at the bottom in this case. Now draw a 18 inch horizontal line at bottom of skirt from the 42 inch front skirt measure line to the 43 inch side-skirt measure line. (This makes the front half of the skirt, the goods being folded.)

Now connect at the $6\frac{7}{8}$ inch point on waist line and draw down an almost straight dotted line six inches to hip measure to correspond somewhat with the curve line previously drawn, and continue down the remainder of the side-skirt measure, to a point extending out at the bottom 18 inches wide. Now draw out the balance of the hip measure, connecting at the 6 inch dotted curve line last drawn at hip measure, and drawing out a horizontal line $10\frac{1}{2}$ inches, which, with the $10\frac{1}{2}$ inch line previously drawn, makes 21 inches, or $\frac{1}{2}$ of hip measure. Now connect at the right terminus of the $13\frac{3}{4}$ inch waist line and draw down a 43 inch curve dotted line for the back length measure. Now draw out for the bottom of skirt a horizontal line 18 inches from 43 inch side-skirt measure line to 43 inch back skirt measure line. Draw out two inches extra at the top and bottom from the 43 inch dotted curve back-skirt measure line, and draw a 43 inch curve line to correspond with the back-skirt measure line, for a 2 inch width line, for two stitched pleats of 1 inch each to be made on each back-skirt piece, and under which a placket on the left side of the skirt is to be formed.

(This work represents the back portion of the skirt, the goods being folded).

NOTE: The two-piece skirt is worn, but many ladies prefer 3 or 4 gores made in a skirt.

N.S. (NO SEAM) GOODS FOLDED

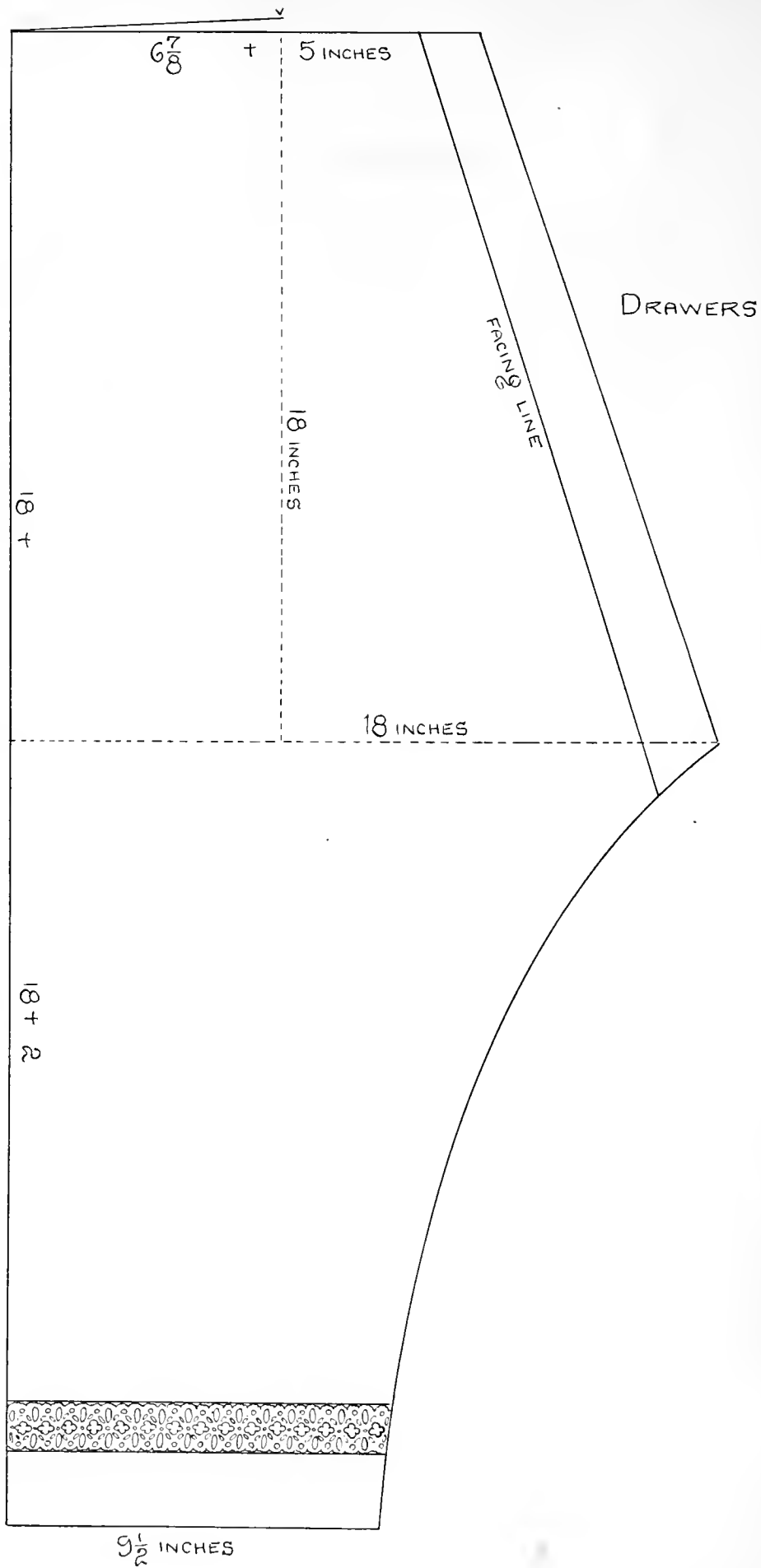

Formula for Drawers.

Draw a horizontal line $\frac{1}{4}$ of waist measure plus 5 inches for gathers. The entire waist measure is $27\frac{1}{2}$ inches, $\frac{1}{4}$ of waist measure is $6\frac{7}{8}$ inches plus 5 inches for gathers is $11\frac{7}{8}$ inches. Measure straight down from waist line over the hips the desired length of the garment. It is 36 inches in this illustration, and draw this 36 inch perpendicular line. Now use the measurement of all around the limb. It is 36 inches in this instance; divided in order to be drafted on paper, it is 18 inches, and is drawn a dotted horizontal line beginning from $\frac{1}{2}$ the distance on first perpendicular line. Draw this line. Also draw down from the right end of the $11\frac{7}{8}$ inch waist line to the end of the 18 inch dotted line, and continue down to the bottom of this garment to a point which measures $9\frac{1}{2}$ inches wide at the bottom, and also draw this $9\frac{1}{2}$ inch horizontal line to connect with the first 36 inch perpendicular line. Make a facing about 2 inches wide on the line which is drawn from right end of waist line to the 18 inch dotted line, in order to strengthen this portion of the garment. Gather the waist line as follows: Gather up $11\frac{7}{8}$ inches and baste it to a belt the $\frac{1}{4}$ of which measures $6\frac{7}{8}$ inches, and continue using the $\frac{1}{4}$ of the belt to the $\frac{1}{4}$ of the goods until the entire belt of $27\frac{1}{2}$ inches is taken up. Still another way to finish the belt is to make a hem and use a draw string.

This work represents one-half the garment, the goods being folded.

CHEMISE

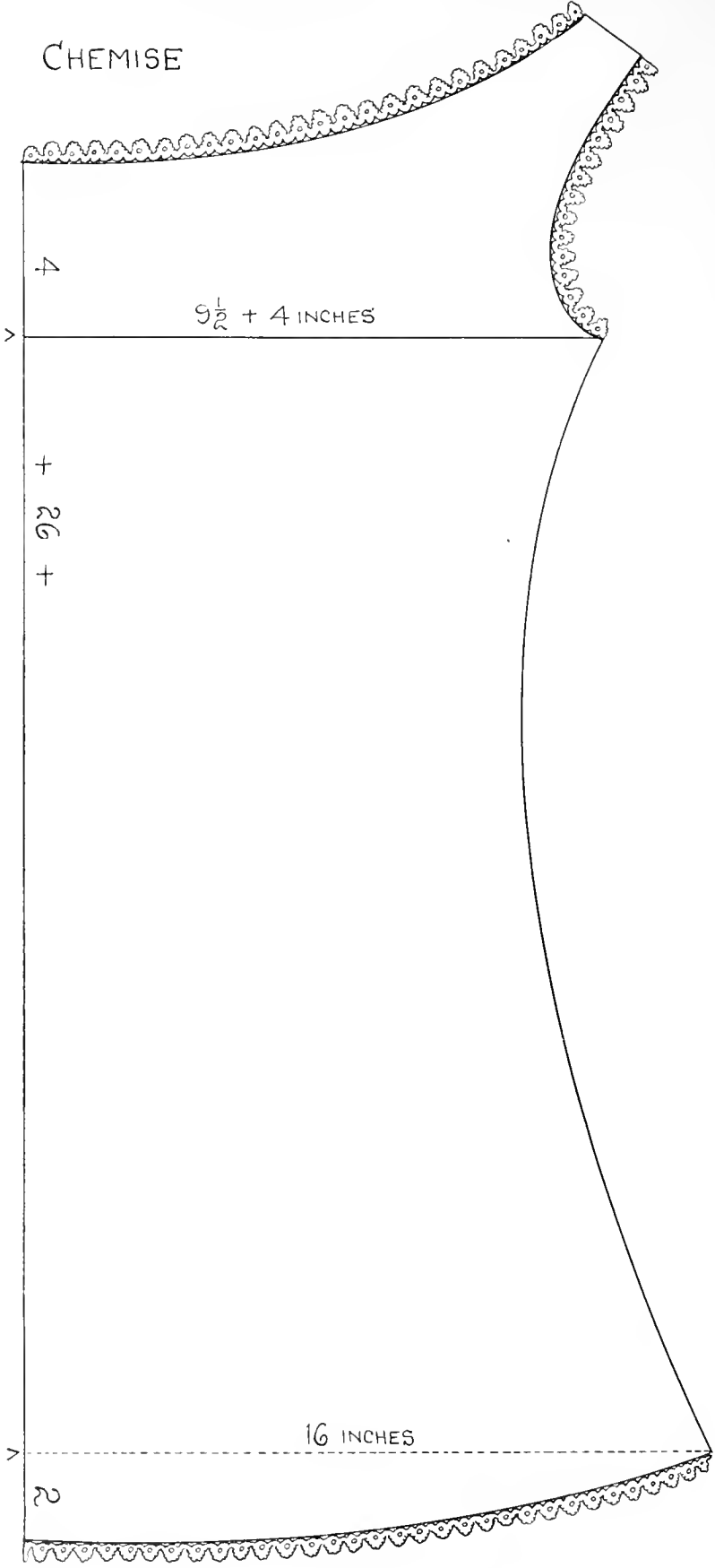

N.S. (NO SEAM), GOODS FOLDED.

Formula for Chemise.

Draw a horizontal line $\frac{1}{4}$ of bust measure plus 4 inches for gathers, which makes a $13\frac{1}{2}$ inch horizontal line. The bust measure being 38 inches, $\frac{1}{4}$ is $9\frac{1}{2}$ inches plus 4 inches for gathers is $13\frac{1}{2}$ inches. Measure for the desired length of garment, beginning from bust measure line; in this instance it is 26 inches plus 2 inches for making bottom curve. Next draw out at 2 inches from bottom of garment from this 26 inch perpendicular line a horizontal dotted line measuring in this instance 16 inches. Next draw up a 4 inch perpendicular line from bust line on this 26 inch line, and draw for top of garment from this last drawn 4 inch line a curve line upward to a height that will produce the arm-hole measure; 16 inches being arm-hole measure, $\frac{1}{2}$ of it is 8 inches. First draw the top of sleeve, make it 2 inches wide, then curve down 8 inches, using curvature on implement. Still continue using curvature on implement and draw a curving line down to meet the 16 inch dotted line, and curve around at the bottom of the garment to join the extra 2 inch line previously drawn.

This work represents $\frac{1}{2}$ the garment, the goods being folded.

To make a Coat.

There are many different styles of coats. One way to make a coat is by an extenuation of the basque. Draw a right angle, thus \perp , using a red pencil, each line being about 8 inches in length, and place neck of the front basque pattern already drafted, which is Figure 4 on diagram, up close to the vertex of this right angle, first writing the letter D on the lower left end of side line of the right angle, the letter E at the vertex of the right angle, and the letter F at the right end of the top line of the right angle. Outline the neck, shoulder in length, and front arm-hole with a blue pencil; also outline the front measure, allowing extra fullness for the bust measure and down the desired length of the coat, as the coat is an outer garment. Also outline the bottom of the coat and side under-arm seam. Now with blue pencil draw from letter F on right angle straight down a proportionate width (this blue line is to be cut out for a seam), passing between the darts of the basque pattern to the desired length of the coat. Use the tracing wheel to produce the coat pattern over the blue pencil lines recently drawn, and one now has two portions to cut out of this transformed basque front, which is Figure 4 on diagram. If the material is wide, with no apparent grain in the cloth, the following is a good way to operate: Having cut the pattern in two portions, as above stated, lay a plait in the goods along the line made from letter F on right angle to the desired length of the coat, allowing the plait in the material to flare from the bust line, and if a close-fitting coat is desired omit this plait entirely, but if the material used is of soft quality, it would be particularly appropriate for the material to flare from the bust line. A silk or satin yoke (either plain, or plaited, and should be trimmed around the edge) formed upon the coat over the seam above the bust line would be very appropriate. A circular yoke pattern may be obtained for this coat by holding a cord or linen tape measure at the vertex of the right angle and swing with right hand from letter D to letter F, using blue pencil, and if a pointed yoke is wanted, which perhaps many would most fancy, connect at letter F on right angle and draw down to the front bust line, cutting out around the circular or pointed yoke at the neck to make it fit the coat already drafted.

The same procedure as was used for making the front coat pattern is followed for making the back coat pattern. For drafting the back of the coat pattern, however, draw the right angle thus \perp , placing the neck of the basque pattern as above stated. If the side seams under the arms appear to be too much on the bias of the cloth, goods for a plait will have to be inserted in the front and back seams from the bust line, thus making three portions for the front coat pattern and three portions for the back. The third extra portions for the front and back coat patterns are made in order that the grain of the cloth will find itself properly.

Any style of collar may be adopted for this coat. Two diagrams of coat collars are given in this book. Either sleeve pattern as shown in this book may be used.

Advanced Course.

Order of Measurements.

Basque.	1. Length of back.....	14½	inches
	2. Under arm	7	"
	3. Bust measure	46	"
	4. Arm-hole	18	"
	5. Arm-curve of arm-hole.....	This measure is solved later arithmetically.	
	6. Width of back.....	15	inches
	7. Shoulder in length.....	5¾	"
	8. Neck measure	16	"
	9. Waist measure	34	"
	10. Width of chest.....	16	"
	11. Entire front measure.....	13½	"
	12. Shoulder line	7½	"
	13. Shoulder point	8½	"
	14. Front test measure.....	17½	"
	15. Hip measure, around the form in adults about 6 inches below the waist line.....	50	"
Sleeve.	1. Take inside length of arm at front	17	"
	2. Top of arm, around it.....	16	"
	3. From 2/3 the way from inside length of arm measure on top of arm measure up to the end of "shoulder point measure"	6	"
	4. Elbow, around it.....	13	"
	5. Wrist, around it.....	11	"
Skirt.	1. Around waist at belt line.....	34	"
	2. Around the hips.....	50	"
	3. Down front to the desired length	42	"
	4. Down back to the desired length.....	44	"
	5. Down side over the hips.....	43	"

The fifth order measurement is obtained as follows: First draw a circle, applying an arithmetical rule, viz.: Rule for finding the diameter of a circle, the circumference being given and expressed as arm-hole measurement. To do this, divide by 3 (omitting the decimal .1416 as stated in arithmetical mensuration), then divide by 2, for the radius. Then use ½ of the radius estimate for the arm-curve of the arm-hole measurement of this symbolical circle in every case. Thus if the arm-hole is 18 inches, divided by 3 is 6, the diameter; divided by 2 is 3, the radius and ½ the radius is 1½ inches. Then use ½ the radius in every case. In the diagram illustration it is 1½ inches, which is ½ the radius. The table showing arm-curve drafting measurements is given for further illustration and convenience.

- If arm-hole is 12 inches in circumference make line upward 1 inch.
- If arm-hole is 13 inches in circumference make line upward 1 1/2 inches.
- If arm-hole is 14 inches in circumference make line upward 1 2/12 inches.
- If arm-hole is 15 inches in circumference make line upward 1 1/4 inches.
- If arm-hole is 18 inches in circumference make line upward 1 1/2 inches.
- If arm-hole is 20 inches in circumference make line upward 1 2/3 inches.
- If arm-hole is 24 inches in circumference make line upward 2 inches.

Basque Diagram.

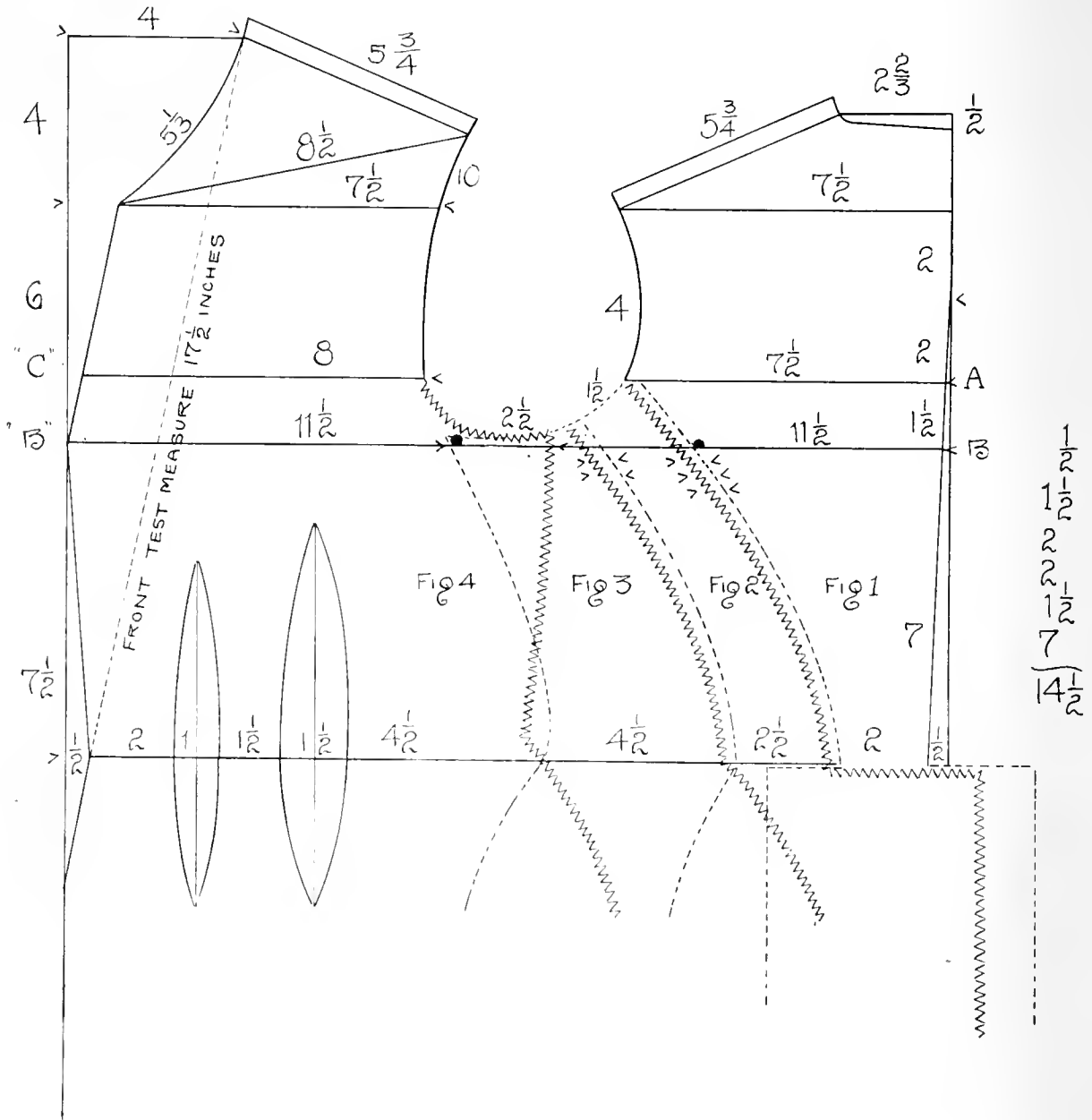

In illustration of the $\frac{1}{4}$ inch basis implement process: If the back length measure is $14\frac{1}{2}$ inches, then $\frac{1}{4}$ of $11\frac{1}{2}$ inches equals $3\frac{5}{8}$ actual inches for the back length measure and the starting of this very small diagram.

When using the $\frac{1}{2}$ inch basis implement process, if the back length measure is $11\frac{1}{2}$ inches, then $\frac{1}{2}$ of $14\frac{1}{2}$ inches is $7\frac{1}{4}$ actual inches for the back measure.

Now for a measurement coming in circular, like bust measure, take $\frac{1}{4}$ of $\frac{1}{2}$ to produce bust line for Figure 1. Bust measure is 46 inches; the regular $\frac{1}{2}$ drafting being 23 inches and which is all the work that can be done on paper, then $\frac{1}{4}$ of 23 inches equals $5\frac{3}{4}$ inches, for the bust line of Figure 1. If $\frac{1}{4}$ equals $5\frac{3}{4}$ inches, $\frac{2}{4}$ is twice $5\frac{3}{4}$ inches, which is $11\frac{1}{2}$ inches, for the bust line of Figures 2 and 3, as shown on diagram. (See two unlettered dots on diagram.)

When ready to draft refer to basque diagram, which represents the work done with the $\frac{1}{4}$ inch basis implement, but the figures thereon, as heretofore stated, represent full inches. Notice that the waist line is very straight around in this certain form, but the "front test measure" always determines whether an extended waist line comes in the front. An extension also in the "back measure" below the waist line may sometimes occur on other forms when it is necessary to reduce the 23 estimate in the "back length measure" in order to make fit better the arm-curve portion.

To make a practical pattern for the human form, use the full inch process, the work of which is done with an ordinary ruler, and the large or second size curvature, or free hand drawing.

The formula for drafting by any of the three processes is as follows:

Get a square piece of Manila or ordinary wrapping paper (drafting paper may be joined with mucilage and brush, but an unbroken piece is the neatest), start the drawing about 4 inches from the top surface, and also 4 inches from the bottom surface. Now draw a perpendicular line the "length of back measure," from the belt line to the top of neck. It is $14\frac{1}{2}$ inches in this illustration. Having drawn this line, dot from the bottom on the same at a point the length of "under arm measure." It is 7 inches in this case. Make dot and mark it "B" for bust line. Next draw a horizontal line out leftward from this dot "B," the desired back bust line, say $\frac{1}{4}$ of the "entire bust measure." $\frac{1}{4}$ of 46 is $11\frac{1}{2}$ inches. Dot again on this first line at a point the height of the supposed back side-body curve. It usually commences where the first seam in the back must be joined in the arm-hole. This estimate must be ascertained for each form by correctly taking the "arm-hole measure," which is 18 inches in this illustration, and using a symbolical circle as follows: Now draw a circle, the circumference of which must equal this measurement, 18 inches. But the arm-hole is not circular, it is oval shaped. How get the curve of this oval-shaped portion? By finding and using $\frac{1}{2}$ the radius. 18 inches is the circumference, the diameter is 6, the radius 3, $\frac{1}{2}$ of 3 is $1\frac{1}{2}$ inches for the "arm-curve measure."

Now draw leftward a horizontal line from "A" for the "width of the back measure." It is $7\frac{1}{2}$ inches in this illustration. Now divide the remaining distance of the "back length measure" into thirds, and dot at $\frac{2}{3}$ the way up from "A" and draw leftward a horizontal line parallel with "A" line, and the same measure. This line will meet at junction of "shoulder line measure," when it is drawn later.

Next draw a horizontal line from top of neck leftward, say $\frac{1}{6}$ of "entire neck measure" (curve it out $\frac{1}{2}$ inch). One-sixth of 16, the "neck measure," is $2\frac{2}{3}$ inches.

(Always as a rule divide the "neck measure" into 6 equal portions, the back portion counting for $\frac{2}{6}$, and the front portion counting for $\frac{4}{6}$. Divide this by 2 in order to draft this work on paper. $\frac{1}{2}$ of $\frac{2}{6}$ is $\frac{1}{6}$. $\frac{1}{2}$ of $\frac{4}{6}$ is $\frac{2}{6}$, therefore, if the "neck measure" is 16 inches, $\frac{1}{6}$ of 16 inches is $2\frac{2}{3}$ inches for the back portion. If $\frac{1}{6}$ is $2\frac{2}{3}$ inches, $\frac{2}{6}$ is twice this, which is $5\frac{1}{3}$ inches, to be used for the front neck curve.) Next draw from neck terminus the "shoulder length measure" $5\frac{3}{4}$ inches, and the back-body arm-curve 4 inches in this illustration.

Now draw waist to this back the number of inches desired; proportion the same according to the waist measure; for there are six parts to be considered, namely, the small-back, the side-back, the under-arm, the side-front, and the front with its dart spaces (refer to diagram).

Now to draw this very small-back waist portion (remember the entire waist measure is 34 inches), always divide in order to put half drafting on paper, and proportion this work as represented in the diagram, and draw this small-back portion $2\frac{1}{2}$ inches, allowing $\frac{1}{2}$ an inch to be deducted in the body-bearings. Finish with a curve blue line; it is dotted on diagram. Use drafting implement curvature; use it not fixedly but movably. Draw this curvature from "A" line down to waist line.

This illustration is shown on diagram, designated Fig. 1.

Now draw fac-simile but red line, marked zigzag line on diagram, from "A" line down to waist line. Draw out on waist line say $2\frac{1}{2}$ inches in this illustration. Now proportionately draw a blue line upwards, marked a dotted line on diagram, and ascending the "arm-curve measurement" draw to the right $1\frac{1}{2}$ inches. (Remember that the next side-body must be drawn $2\frac{1}{2}$ inches to the right, thus leaving a balance for the front-arm piece.)

This illustration is designated on diagram, marked Fig. 2.

Next draw a red curve line marked on diagram zigzag line, like last back-side body; also draw out at waist line $4\frac{1}{2}$ inches in this illustration. Now draw a straight temporary line upward a proportional width to a point, the "under-arm measure," which is 7 inches. Now draw at the terminus of the $\frac{1}{4}$ of the whole bust measure, $\frac{1}{2}$ showing on drafting, a curve line at the top $2\frac{1}{2}$ inches to the right for arm-curve, and erasing temporary line, curve down from the terminus of $\frac{1}{4}$ of bust line to waist line, using blue pencil; it is marked dotted line on diagram.

This illustration is shown on diagram, marked Fig. 3.

Begin and draw a slightly curving red line, marked on diagram zigzag line, up from left end of $4\frac{1}{2}$ inch waist portion line to arm curve, the same as drawn in Fig. 3. It is 7 inches, and it is the "under-arm measure." Next draw leftward the remaining distance of the bust measure, which is $\frac{1}{4}$ of the entire bust measure, or $11\frac{1}{2}$ inches, starting this line from the top of the "under-arm measure" line just previously drawn. (Observe on the diagram, in this instance, that the bust-lines lap under the arm for this certain form.) Having drawn the remaining distance of the bust-line measure, dot and mark the terminus "B" for bust-line.

Having assumed that the oval-shaped portion of the arm is one-half of the arm-hole measurement in every case, and which in this illustration is 9 inches, and as the oval-shaped portion already drawn in this instance measures 4 inches, then 4 inches minus 9 inches is 5 inches, for the remainder of this oval-shaped portion, but 5 inches is found to be 1 inch too much, to be true to the arm-hole measurement, which in this illustration is 18 inches, but this oval-shaped portion, as heretofore mentioned, can be decreased or increased in order to secure a good fit, but the bust line cannot, and the arm-hole measurement must also be true. So then draw the next body-piece-curve 4 inches, beginning this line from the top of the under-arm measure line (making the entire oval-shaped portion in this instance 8 inches), curving this line $1\frac{1}{2}$ inches in altitude (as ascertained in each case for the 5th order of measurements), and dotting it at top terminus. This is a zigzag line on diagram.

Having dotted at our last procedure, draw a horizontal line leftward from this arm-curve dot. This line is a continuation of "A" line; draw it $\frac{1}{2}$ of "chest measure" ($\frac{1}{2}$ of 16 is 8), now mark the terminus "C" for "chest measure." Next draw a line from "B" line straight up to the top of neck, or collar bone, 6 inches, which line is gaugeable but represents part of the "entire front measure." Also draw another line, calling it "varying line," because it varies to meet the requirements of different sizes of front neck measures. In this instance presume that it varies 1 inch and if found not correct, the length of the "front neck curve measure" and the "shoulder line measure" will show it, after these two latter measurements are drawn, and then erase the "varying line" and adjust it. Next draw out the "shoulder line measure," which is a $7\frac{1}{2}$ inch horizontal line drawn from the top of "varying line"; also draw out the "shoulder point measure," from top of "varying line," $8\frac{1}{2}$ inches

to a point which is the remaining distance of the arm-hole measurement, and in this instance is 6 inches. Next consider how to draw the neck curve, and in our former neck calculation we have found it to be $5\frac{1}{3}$ inches. Draw it out, using curvature of implement.

Next draw a straight line up from this 6 inch gaugeable line, naming it "New line." Draw it always in length the difference between the "entire front measure" (which represents the 10th order of measurements), and the "front test measure" (which represents the 14th order of measurements). The front test measure commences at the highest point on the shoulder by the neck, and extends to waist line. The former measure (of the 10th order), is $13\frac{1}{2}$ inches, and the latter measure (of the 14th order), is $17\frac{1}{2}$ inches. This "New line," therefore, must be drawn the difference between the last two order of measurements, which is 4 inches. Draw it. Another way to find the front neck curve is as follows: Let this new 4 inch line just mentioned be the vertex of a right angle, which calls for another equal line. Draw it. Now swing tape from this vertex and it will produce the front neck curve, less the "varying line space," which shows 1 inch in the diagram illustration.

Next draw the "shoulder in length"; it is $5\frac{3}{4}$ inches, drawing from top of $5\frac{1}{3}$ inch front neck curve line to right end of $8\frac{1}{2}$ inch "shoulder point measure" line. (Remember that the "shoulder line," the "shoulder point," and the "shoulder in length" are three separate order of measurements.) Next examine the arm-hole measurement; sum up and deduct the previous arm-curve work from full arm-hole measurement, which in this illustration is 18 inches. The result will give the measure for the front-arm-body-piece. Draw it. Now connect at "B" and draw a perpendicular line down $7\frac{1}{2}$ inches to waist line, which, with the 6 inch "varying line" previously drawn, makes $13\frac{1}{2}$ inches, the "entire front measure."

Again draw out on this diagram the front waist line, drawing from line to line. Now consider how to center the darts, or no darts, but body-bearings. In this case we will make two darts. Proportion them nicely. First count up the back and two-side body waist line measurements, and deduct same for the front waist line; this procedure will show the correct waist line, and the number of inches to be placed into darts and body-bearings. Illustration: If back and two-side-body waist lines add nine inches, and the entire waist measure is 34 inches, then $\frac{1}{2}$ of 34 is 17 inches, and the back and two side-bodies add 9 inches, then 9 inches minus 17 inches, is 8 inches wanted for front waist line. Now this straight waist line measures 11 inches; then put the difference between 8 and 11 inches, which is 3 inches, into darts and body-bearings. Dot at $\frac{1}{2}$ an inch for body-bearings, dot for 2 inches, dot for small dart; space again, say 1' inches; dot again for dart an inch and one-half, making a total of 3 inches in darts and body-bearings. Then make the darts as high and as low as desired, and use curvature to shape them. To make drafting below waist line, bear in mind the swell of the "hip measure." It is 50 inches in this illustration. Now having finished the drafting, do not forget to make the notches on bust line, and as shown on diagram. These notches are made in each case as an aid in keeping the bust line true when basting the cloth seams together.

This work is designated on diagram, marked Fig. 4.

In tracing off this pattern, allow $\frac{1}{2}$ an inch for all seams except at neck and arm-hole, but before doing this take implement or tape measure (it not having been stretched), and go over the work. If any discrepancies are found, make them conform to first original measurements. This painstaking in the review of the drafting process is a test, something like taking a trial balance in book-keeping.

Observe on diagram the two body-portions measuring $4\frac{1}{2}$ inches each. Now if an extra side-body is preferred add these two portions, making 9, and divide by 3. Then make 3 body-pieces instead of 2. Another situation will sometimes occur in drafting for stout ladies, to be true to the bust-line the arm-hole will come too large. To alleviate this fullness, fasten a plait in the lining of the goods, or cut out this defect from the pattern, having previously drafted for it.

This situation is shown on third diagram herein.

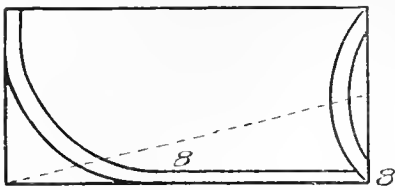

- Coat shape collar

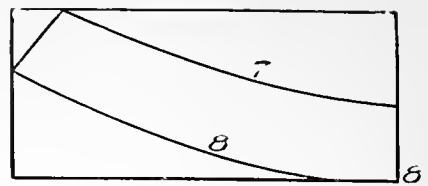

- Standing collar

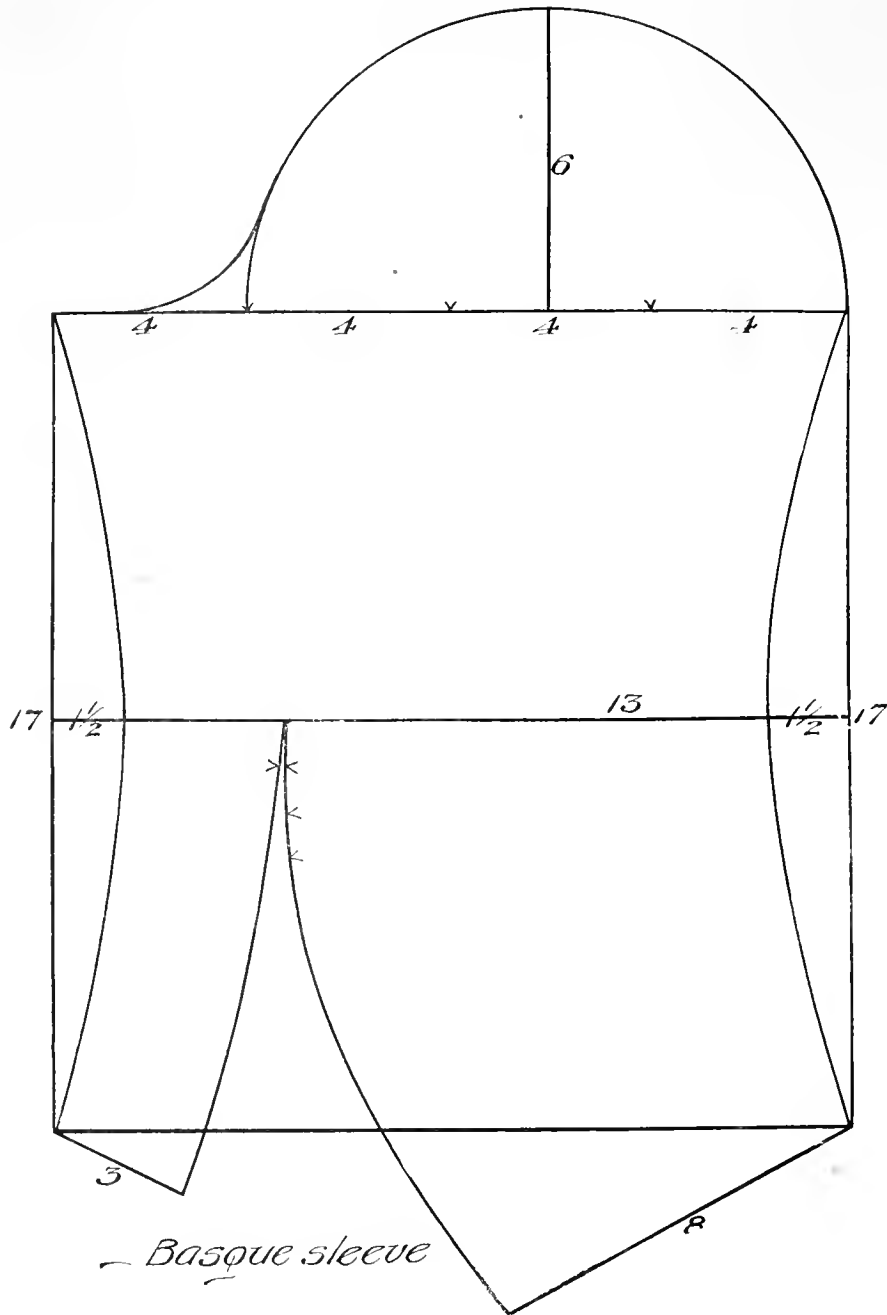

- Basque sleeve

For Drafting a Standing Collar.

Draw a straight line in length $\frac{1}{2}$ of neck measure. It is $\frac{1}{2}$ of 16 inches in this illustration. Draw on the right, and also on the left of straight line lines in altitude $3\frac{1}{2}$ inches, or more if desired. Draw the top line $\frac{1}{2}$ of neck measure. Use drafting implement and draw lower curve in this space 8 inches, and upper curve $\frac{1}{2}$ inches. For a coatshaped collar, use the neck measurement previously drawn. (See diagram.)

Formula for Sleeve.

Draw a perpendicular line the measure of "inside length of arm at front." It is 17 inches in this case. Draw rightward from the top of this 17-inch perpendicular line a horizontal line the measure of "top of arm." It is 16 inches here. Now draw downward and across, forming a rectangle. Dot rightward from first 17-inch perpendicular line at $\frac{1}{2}$ plus 2 inches of the way on top 16-inch line. Dot on the first 17-inch perpendicular line $\frac{1}{2}$ the way for the elbow measurement, which is a 13-inch horizontal line, and draw it. Find the difference between the top of arm measure and the elbow measure, and use the difference for the elbow curve, as shown on diagram. The difference between 13 and 16 is 3, divided for each side of the sleeve is $1\frac{1}{2}$ inches. Use drafting implement and curve out $1\frac{1}{2}$ inches on each side of sleeve for sleeve line, as shown on diagram. Draw a curved line obtusely down to the right from about $\frac{2}{3}$ the way on 13-inch horizontal line from the right 17-inch perpendicular line to a distance about 5 inches below bottom of 16-inch horizontal line and continuing a line 8 inches long upward to the bottom end of the right 17-inch perpendicular line; also draw a similar curved line obtusely down to the left, beginning also at about $\frac{2}{3}$ the way on 13-inch horizontal line from the right 17-inch perpendicular line, to a distance of $1\frac{1}{2}$ inches below the bottom of 16-inch horizontal line and continuing a line upward 3 inches long to the bottom end of the first 17-inch perpendicular line. These 2 portions of 8 and 3 inches make 11 inches, the wrist measurement. (See diagram.) The right or upper sleeve portion line (measuring 8 inches wide at bottom), is drawn longer than the left or under sleeve portion line (measuring 3 inches wide at the bottom), in order to allow for gathers at the elbow. The right upper portion is to be gathered at elbow when joining the upper and lower portions together. Having dotted at $\frac{1}{2}$ the way, plus 2 inches on first 16-inch horizontal line, proceed and draw $\frac{1}{2}$ a circle thereon. The radius of this circle will be 6 inches. Swing tape to get this circle, and finish out the circle measurement on the left side with a curved line to connect with the left end of the top 16-inch horizontal line.

The Skirt.

The skirt formula has been previously given in this book. This drafting is, however, done on the same principle as the lower part of the basque. Dot on the waist line for the front piece, side-gores, and the back. Refer to "measure book," and this drafting will not be troublesome, if prepared with a high, long table.

Next commence the study of the remaining diagrams. The third basque diagram represents the pattern for a stout lady. The fourth diagram represents the pattern for a doll.

Find and place the measurements of the diagrams in their proper order. Neck, waist, bust, under-arm, and the back are given in the third diagram, but commence the study, using the 1st, 2d, 3d, 4th, 5th, 6th, 7th, 8th, 9th, 10th, 11th, 12th, 13th, 14th, and 15th order of measurements.

Sewing Suggestions.

A practical way to learn to dress-make is to draft an exact pattern of a person and cut it out of very strong cloth, and sew it closely on the sewing machine. Cover the neck and arm-hole openings, and press in cotton or excelsior. After this is done, close the bottom of the form with paste-board and cloth, and place this form on a stand measuring downward the balance of the form measurement. This will make a fair model for dress-making and designing purposes.

Sewing Definitions.

Cloth is known by its fiber. It is also called fabrics or textiles. Cloth is designated when it comes to the making as the "lengthwise," the "crosswise," the "bias," and the "selvedge." The weave and the woof are the cross threads worked upon the loom by the weaver. The weave side is visibly seen in woolen goods, and in carpets, generally known as the wrong side of cloth. A seam is two pieces joined together by stitching. A fell is a seam with one side so held as to overlap the other, and then be stitched neatly down.

A tuck in cloth is like a seam except the desired width of tuck is worked upon cloth uncut, and pressed flatly down.

A gusset is an angular piece of cloth used at the terminus of a seam, to give strength and finish. To mend a rent, use a piece of cloth back of it, and darn neatly and smoothly down.

A gather is a large piece of cloth proportioned to meet a smaller one.

To press seams, dampen with luke warm water and use a heated iron not very heavily.

To bone a dress requires care and patience. Whaleboning is usually overseamed by hand, and placed in all the lower waist line seams. Featherboning is often done with a sewing machine attachment.

Binding is used for the bottom of skirts, or anything that is to be bound.

Popular names of cloth: Broadcloth, Serge, Silk, Satin, Brocade, Grenedine, Cashmere, Scotch Plaids, Cheviots, Oxfords, Meltons, Tweeds, Corduroy, Velvet, Velveteen, Pame, Chinchilla, Messeline, Crepe-de-chine, China Silk, Chiffon, Taffeta, Albetross, Cotton, Linen, Cotton Flannel, Flannelette, Delains, Chalice, Gingham, Paqua, Challies, Batiste, Dimities, Lawn, Indian Lawn, Swiss, Tarlton.

Woolen and Henrietta goods are obtained in the following colors: Cream, rose, red, cardinal, shell, pink, light blue, Nile, sapphire, orange, pink, marine blue, cadet blue, green, brown, mulberry drab, chocolate, slate, bronze, cerise, garnet helio, canary, plum, russet, black, and etc.

Linings: Cambric, percale, selicia, sateen, haircloth, shrunk canvas.

Stiffenings: Crinoline, linen duck, wigin, buckinrum.

Trimmings: Lace, ribbon, buttons, buckles, braid, fringe, jet.

Passementerie: Knife-plaiting, accordion-plaiting, pinking, applique work.

Fancy stitching: Edging, embroidery, insertion, tucks, and etc.

The following is an example to solve: How many models can one get of two sizes out of a sheet of press-board measuring 24 x 32 inches, the larger model measuring 11 x 5 inches, the smaller one $5\frac{1}{4} \times 2\frac{1}{4}$ inches respectively. To make an equal number of them, how many can one get? Answer: 9 of each kind.

Then how many sheets of press-board will one have to buy to make 999 models each? Answer: 111 the number of sheets.

Will this example bring the same result by arithmetic as by diagram? Illustrate it by diagram, using the $\frac{1}{4}$ -inch basis drafting implement, which has heretofore been designated as the unit for one inch.

Having solved the above example, how many models can be cut of cloth, each laid on the lengthwise fold of the goods? Answer: 8 large ones and 11 small ones.

If 999 models of press-board of each size cost \$20.00, what is the average cost of these two models of unequal size? Answer: 1 cent.

Example by plain arithmetic: How many models can one get out of a piece of cloth measuring 12 yards long and 54 inches wide, model being 3 inches wide and 6 inches long? Solution: 12 yards equals 432 inches; divided by 6, equals 72 lengths. 54 inches, divided by 3, equals 18 widths. Length multiplied by width, 72×18 , equals 1,296 models—the answer.

Arm Curve Solution

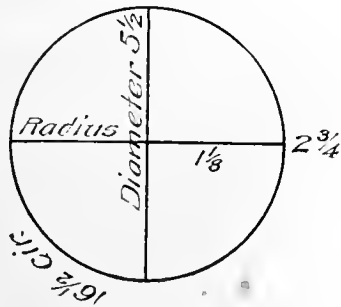

$5 \frac{1}{2} = 11 \frac{1}{2}$

$\frac{1}{2}$ of $11 \frac{1}{2} = 11 \frac{1}{4} = 22 \frac{1}{4}$

$22 \frac{1}{4} = 11 \frac{1}{4}$

$\frac{1}{2}$ of $11 \frac{1}{4} = 11 \frac{1}{8} = 22 \frac{1}{8}$ for A

- Neck 15-
- Waist 39 & 50 on -
- Bust 48-
- Under arm measure 7-
- Back is 16-

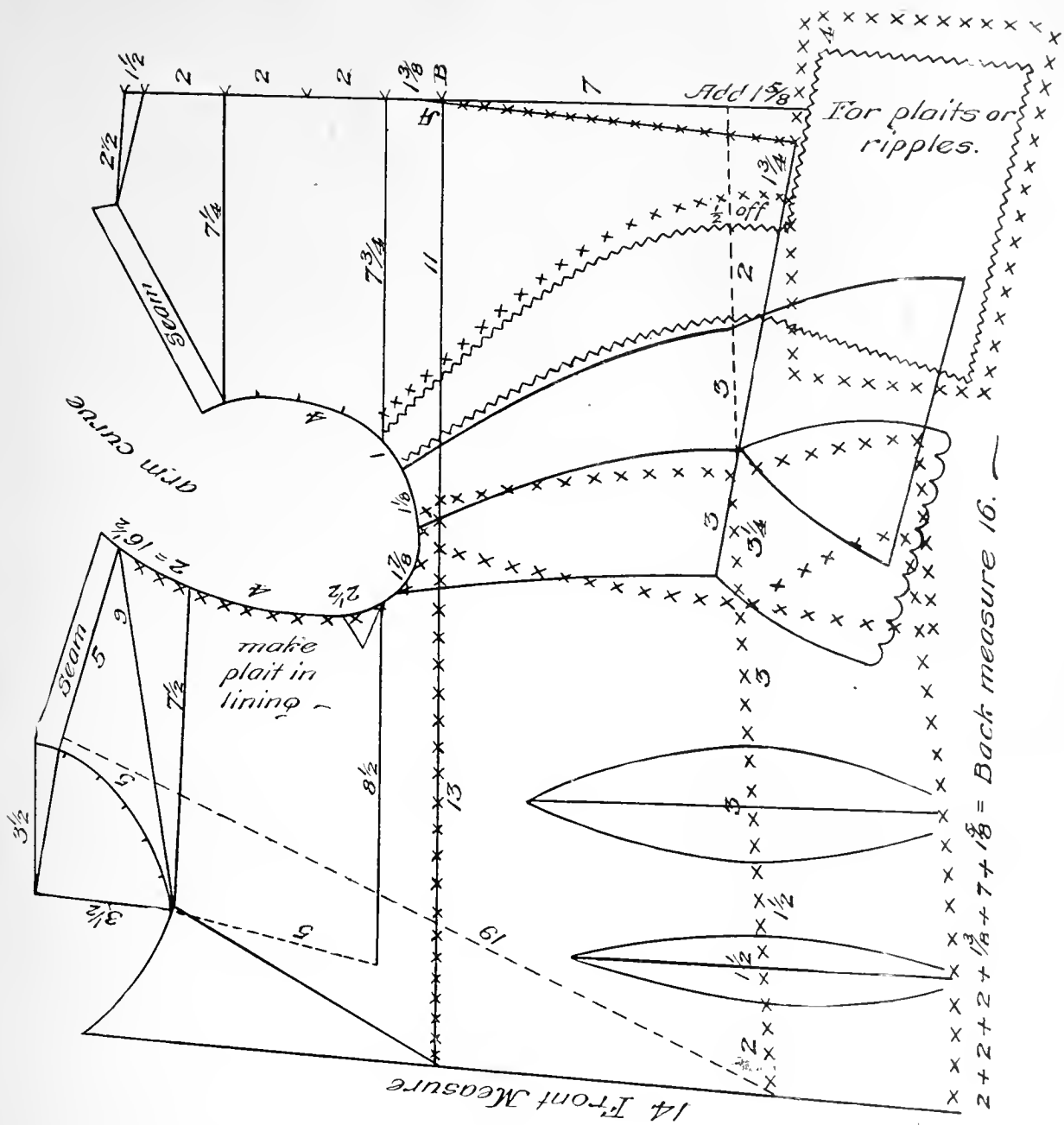

Single breasted jacket
for a dolly -

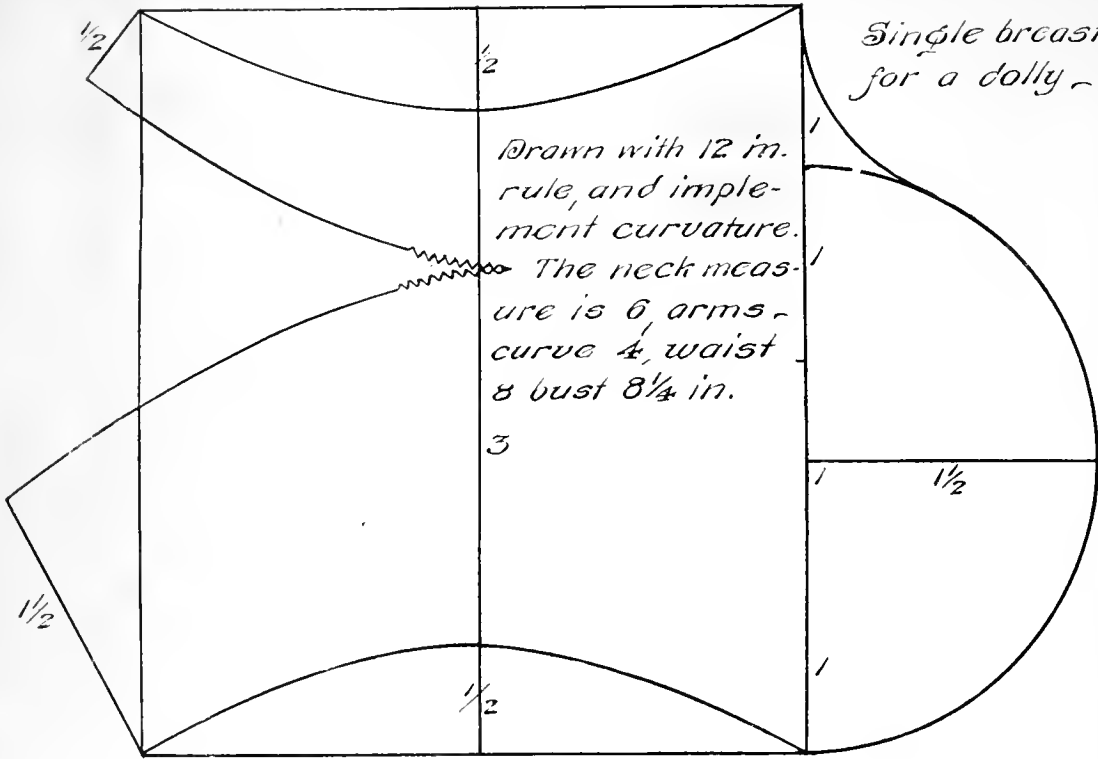

Drawn with 12 in.
rule, and imple-
ment curvature.
The neck meas-
ure is 6 arms -
curve $\frac{1}{2}$, waist
8 bust $8\frac{1}{4}$ in.

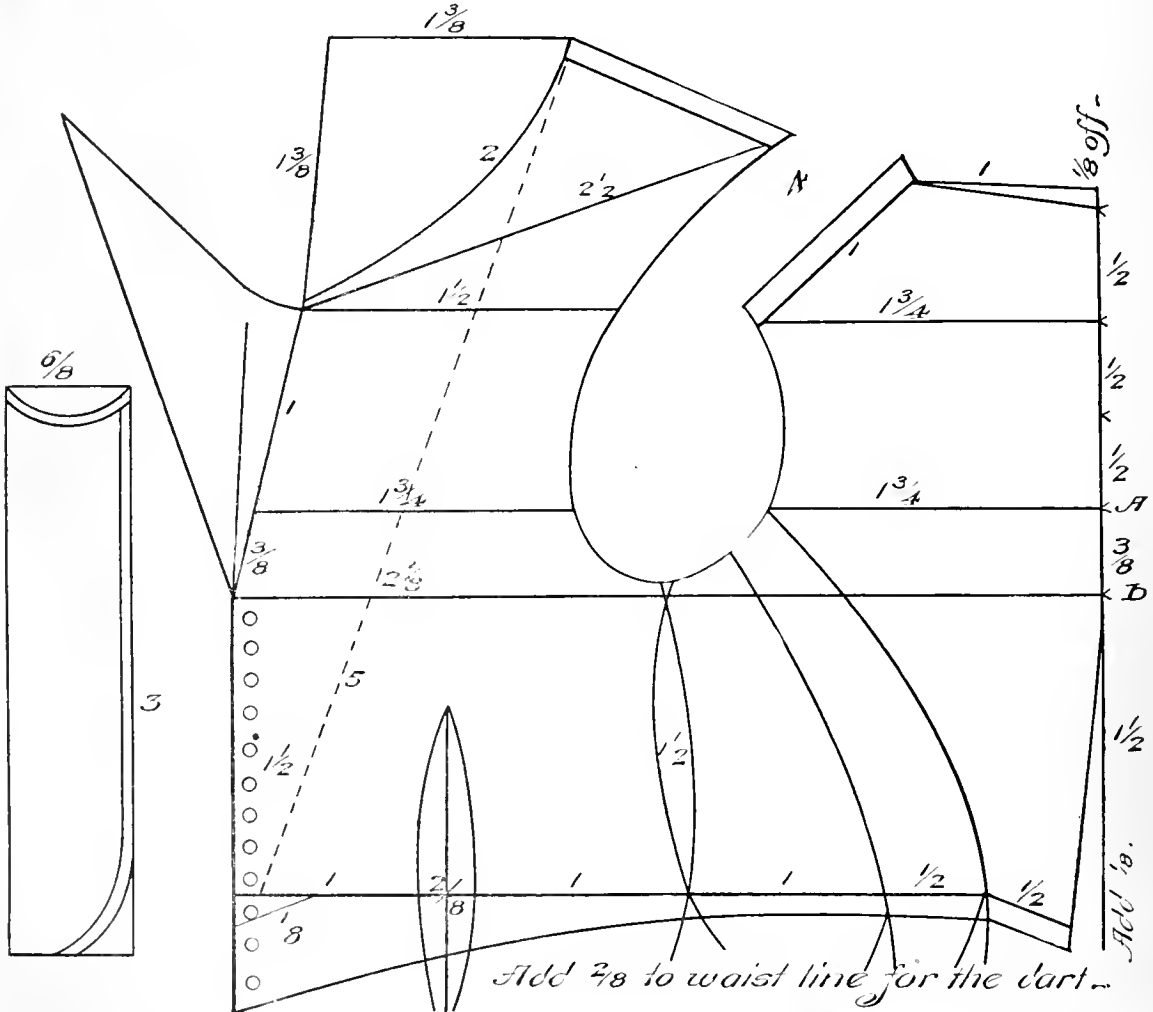

Add $\frac{3}{8}$ to waist line for the dart -

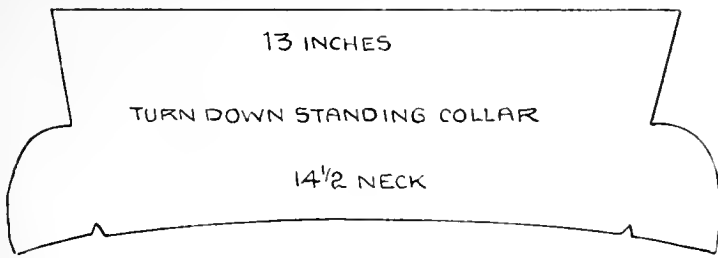

DRAWN ACCORDING TO THE PRINCIPLES OF
 COPYRIGHTED MANUAL OF APPAREL DRAFTING
 AND SEWING BY
 MRS MATTIE G. KUNZ

BUST 40 INCHES

(DRAW 3 IN EXTRA FOR GATHER FULLNESS FOR BUST AND 1 IN.
 FOR FRONT HEM IN FRONT PORTION, AS SHOWN.)

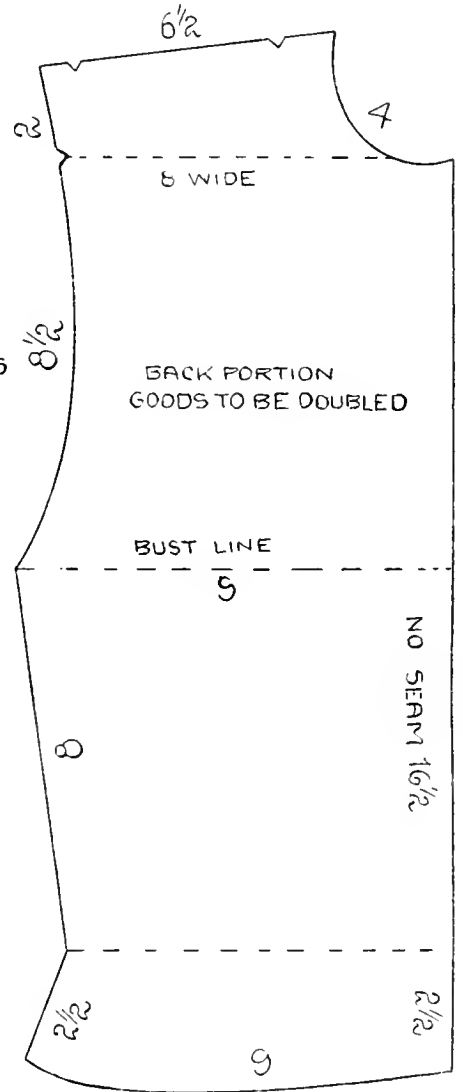
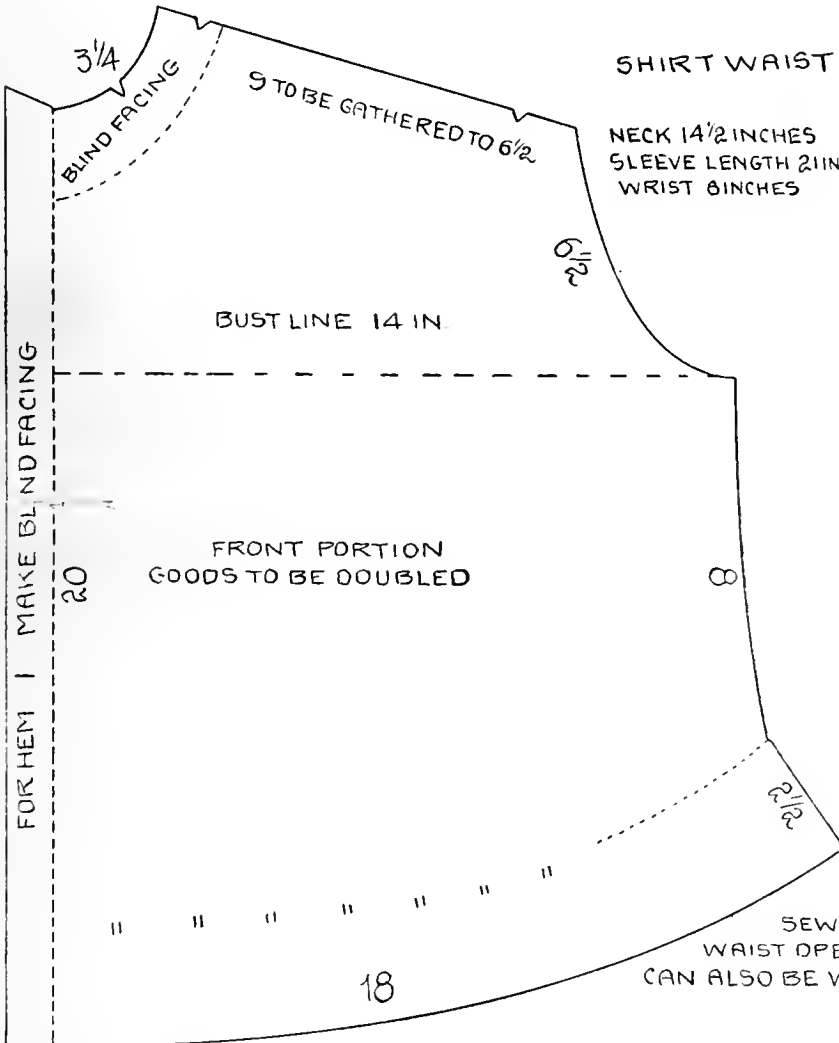

SEW AN INSIDE FACING TO FRONT
 WAIST OPENING, AS SHOWN THE COLLAR
 CAN ALSO BE WORN AS A LOW TURN DOWN COLLAR

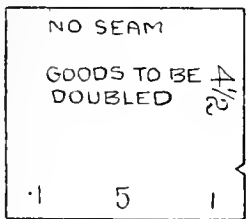

CUFF

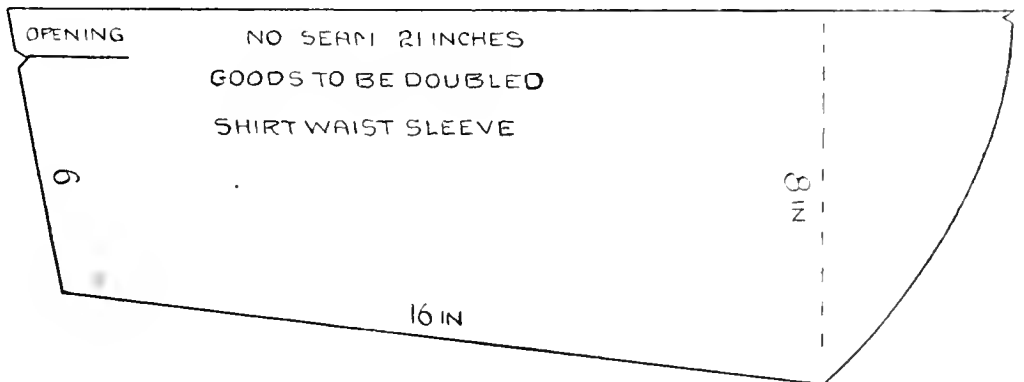

TT515
.K8

This garment is drawn on a scale of $\frac{1}{8}$ of an inch to represent the inch, as the drafting will fit the size of the book. The $\frac{1}{4}$ inch basis only is recommended for study purposes. To make a large pattern use the figures on this diagram as actual inches. If the goods is white, so that the drawings will show on the goods it will not then be necessary to make a pattern. Drawn according to the principles of copyrighted Manual of Apparel Drafting and Sewing, by

Mrs. Mattie G. Kunz.

Measurements.

Waist 30 inches -- For high waist 33 inches.

Hip 47 "

Front length - -42 inches

Side " - -43 "

Back " - - 43 "

May be made habit back, or with inverted pleat.

To produce a fashionable flare ruffle to be attached to a waist and worn with skirt, draw a circle the circumference of which equals the waist measure, and divide circumference or waist measure by 3 to get the diameter, then measure down from this circle the depth of the ruffle desired and draw the second circle around the first circle. If there is more fullness than desired cut the pattern at the front and trim it off. A cuff may be produced in the same manner.

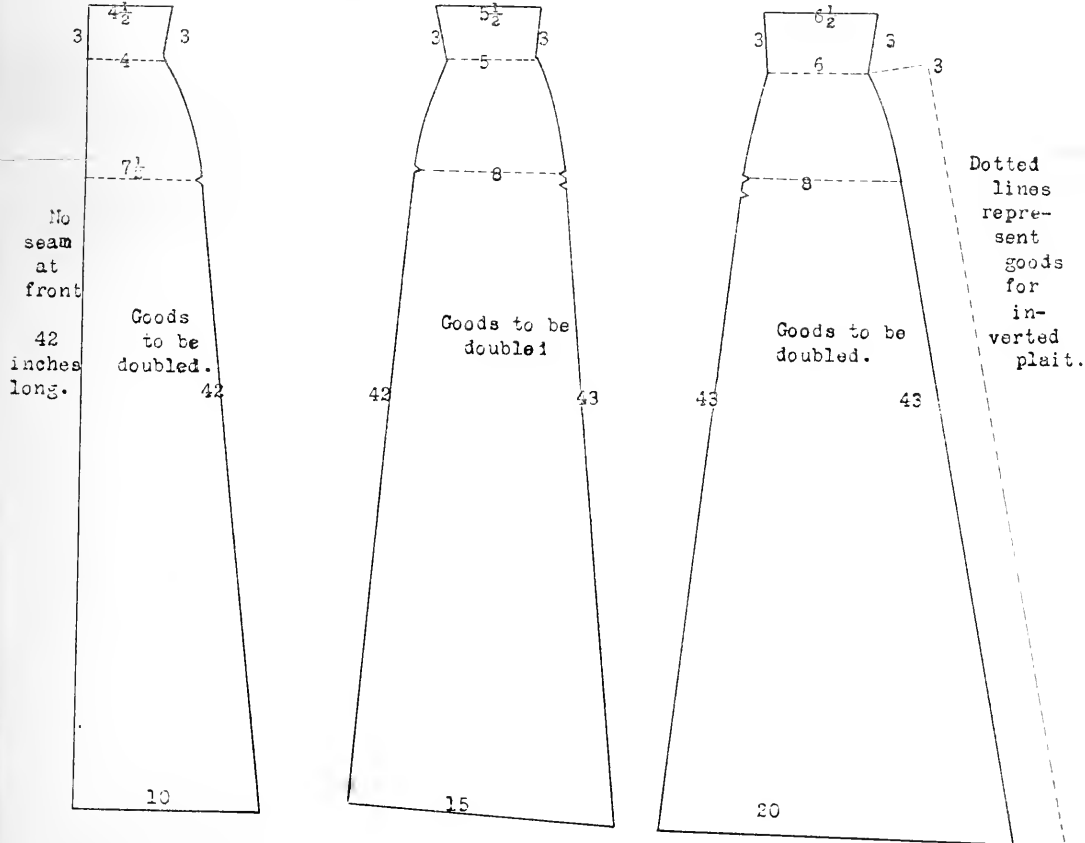

TT515
.K8

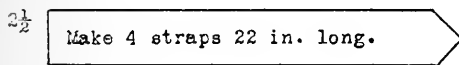
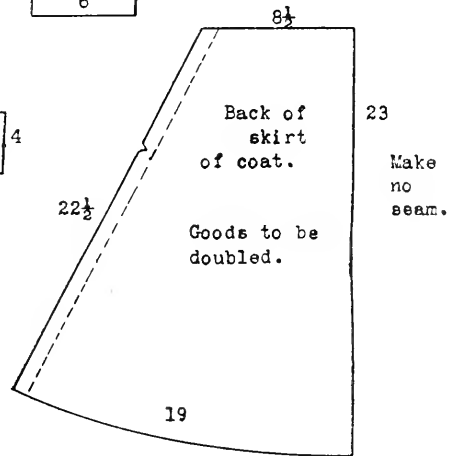
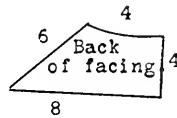
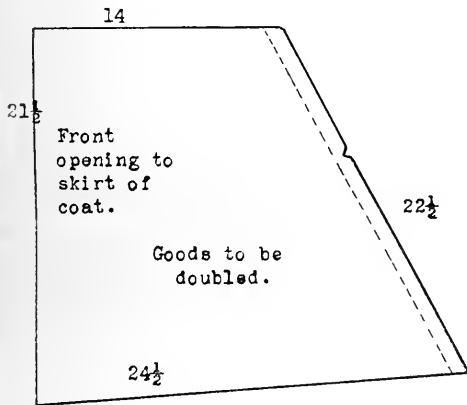
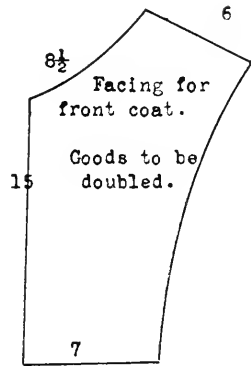
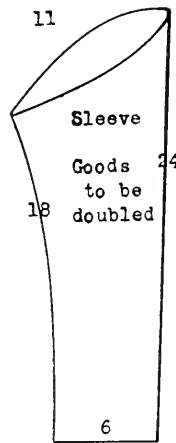
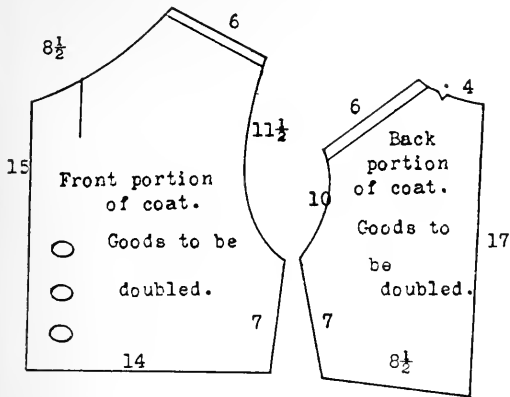

Collar

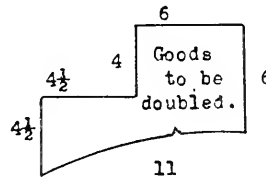

Fashionable coat for a lady whose measurements are:

Bust 40 inches.
Waist- 28 "
Neck - 14 "

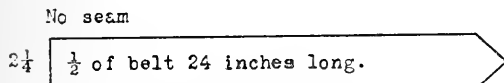

Drawn on a scale of 1/8 of an inch to represent an inch. To make big pattern use the figures on this diagram. Drawn according to the principles of copyrighted Manual of Apparel Drafting and Sewing, by Mrs. Mattie G. Kunz.

Straps to be stitched over each shoulder to the waist line with an opening allowed for the belt to pass under.

TT515
·K8

This garment is drawn on a scale of $\frac{1}{3}$ of an inch to represent the inch, as it is for book presentation. To make a large size pattern use the figures on the drafting as inches. If the goods is white so that the drawings will show on the cloth it will then not be necessary to make a pattern. Drawn according to the principles of copyrighted Manual of Apparel Drafting and Sewing, by

Mrs. Mattie G. Kunz.

Princess dress.

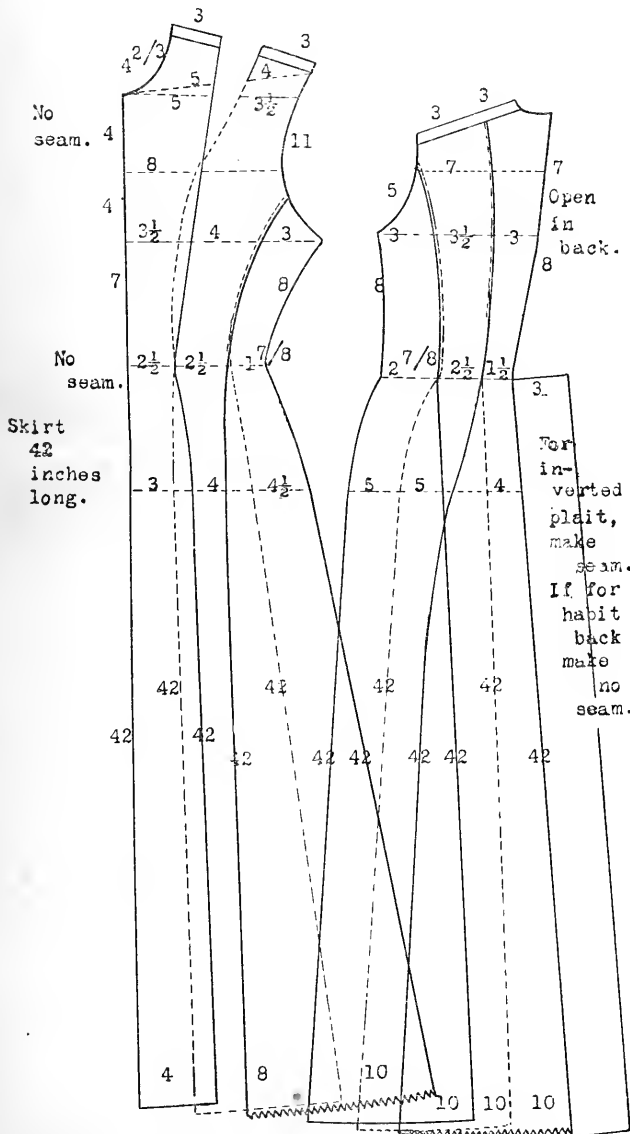

Measurements.

For this style of dress and for front portion use these measurements.

First draw length of front waist, which is as follows:

Front -- 15 inches.
 Front bust -- $10\frac{1}{2}$ "
 (Entire bust being 40 inches)

Under arm -- 8 inches
 Front waist $6\frac{7}{8}$.
 (Entire waist being $27\frac{1}{2}$ inches)

Chest --- 8 inches.
 Shoulder line $8\frac{1}{2}$ inches.
 Shoulder point-- 9 inches.

Front neck $4\frac{2}{3}$ inches.
 (Entire neck being 14 inches.)
 Shoulder in length 6 inches.
 Front arm curve 11, back arm curve 5 inches.

Back width measure 7 inches.
 Back length 15 -- "
 Hip measure -- 53 "

Front skirt length -- 42 inches.
 Side " " -- 42 "
 Back " " -- 42 "

Any style of sleeve shown in this book may be used in this

Princess dress.

Goods to be doubled in each piece in this dress.

TT515
.K8

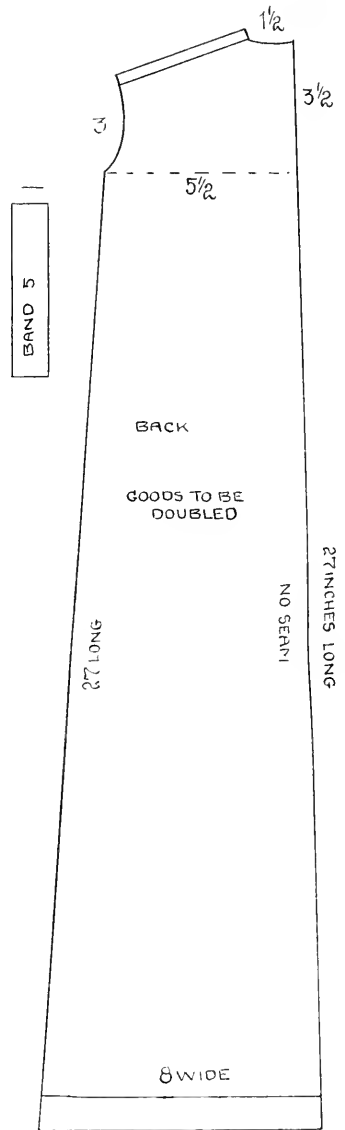
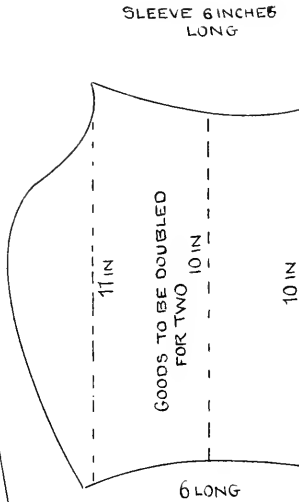
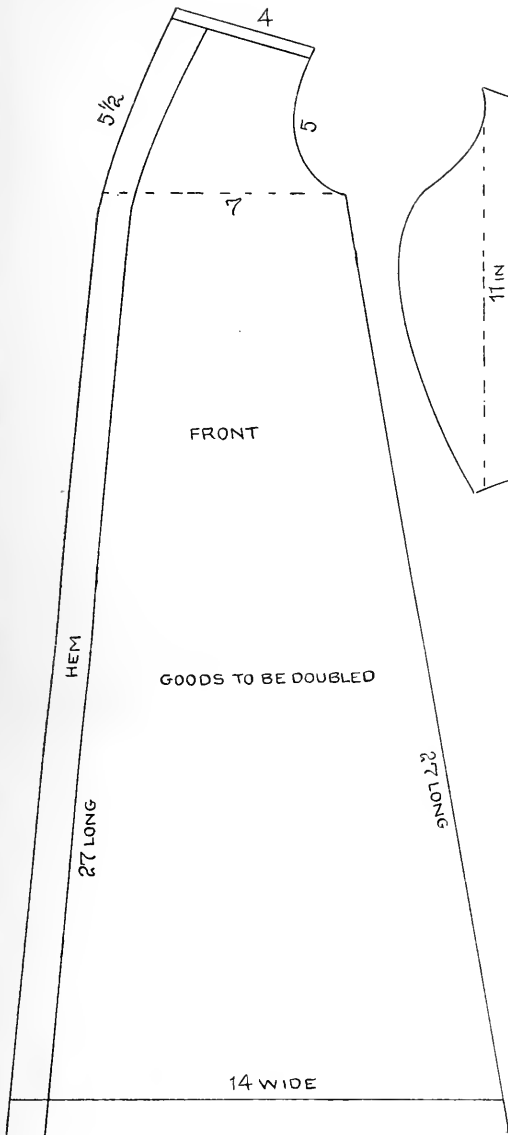

INFANTS WRAPPER AGE 1 YR

DRAWN ACCORDING TO THE PRINCIPLES OF COPYRIGHTED MANUAL OF APPAREL DRAFTING AND SEWING, BY

MRS MATTIE G. KUNZ

TT515
.K8

BABY CAP

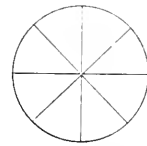
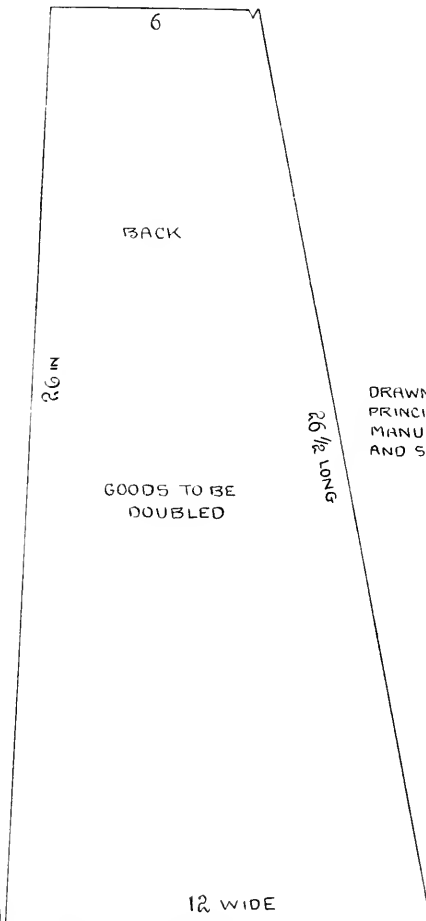
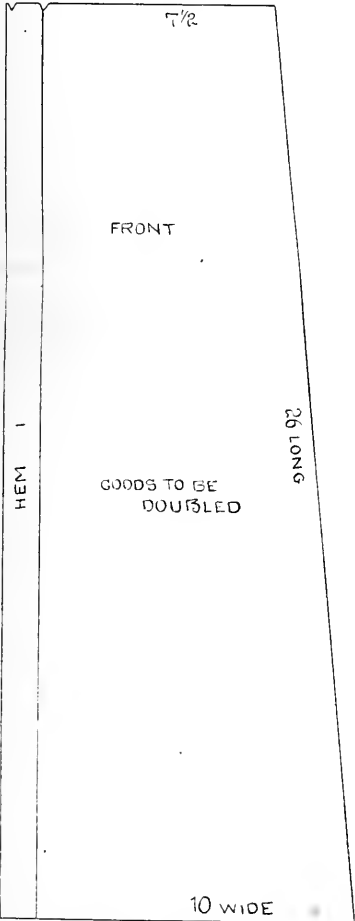
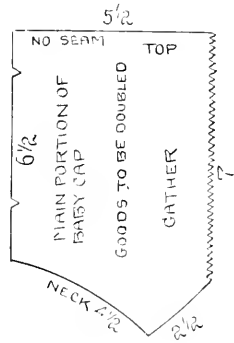
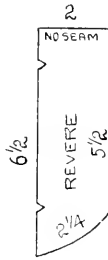
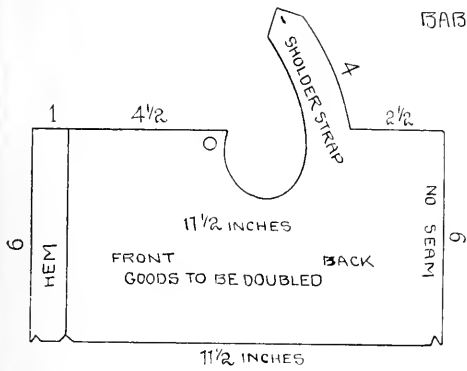

CIRCLE FOR BACK OF CAP

DRAWN ACCORDING TO THE PRINCIPLES OF COPYRIGHTED MANUAL OF APPAREL DRAFTING AND SEWING BY MRS. MATTIE G. KUNZ

26 IN LONG

HEM 1

51 1/2 LONG

GOODS TO BE DOUBLED

10 WIDE

26 IN

GOODS TO BE DOUBLED

12 WIDE

26 1/2 LONG

TT515
.K8

INFANTS CLOAK WITH CAPE

DRAWN ACCORDING TO THE PRINCIPLES OF COPYRIGHTED MANUAL
OF APPAREL DRAFTING AND SEWING BY
MRS. MATTIE G. KUNZ

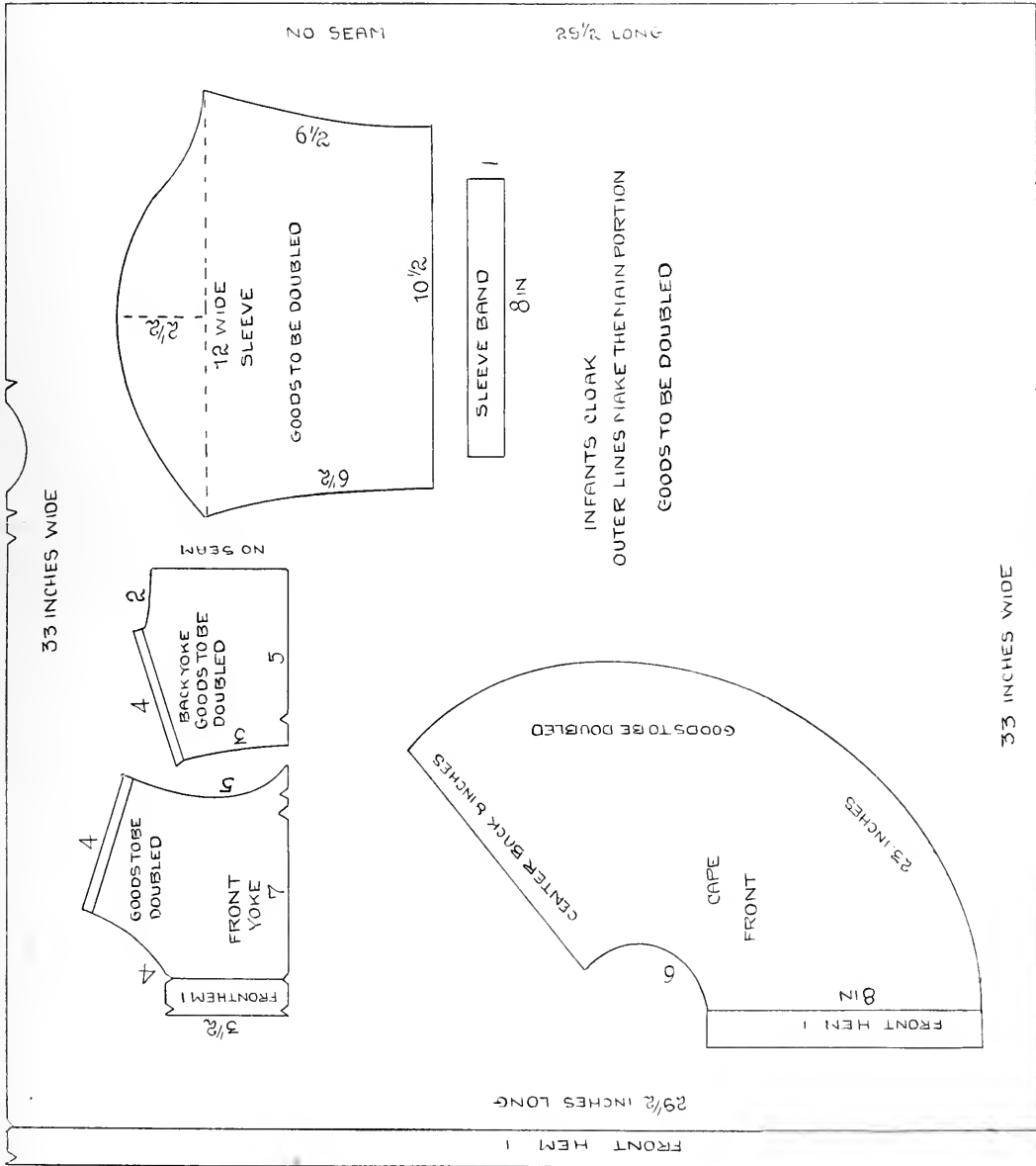

1512
8

INFANTS DRESS

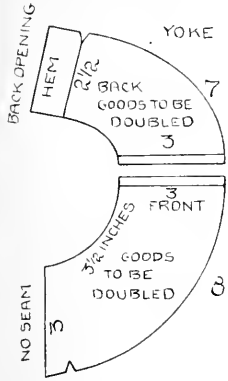

AGE 1 YEAR

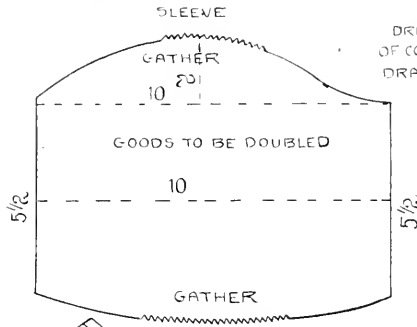

DRAWN ACCORDING TO THE PRINCIPLES OF COPYRIGHTED MANUAL OF APPAREL DRAFTING AND SEWING BY MRS MATTIE G KUNZ

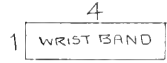

NECK 10 INCHES
BUST 16 INCHES

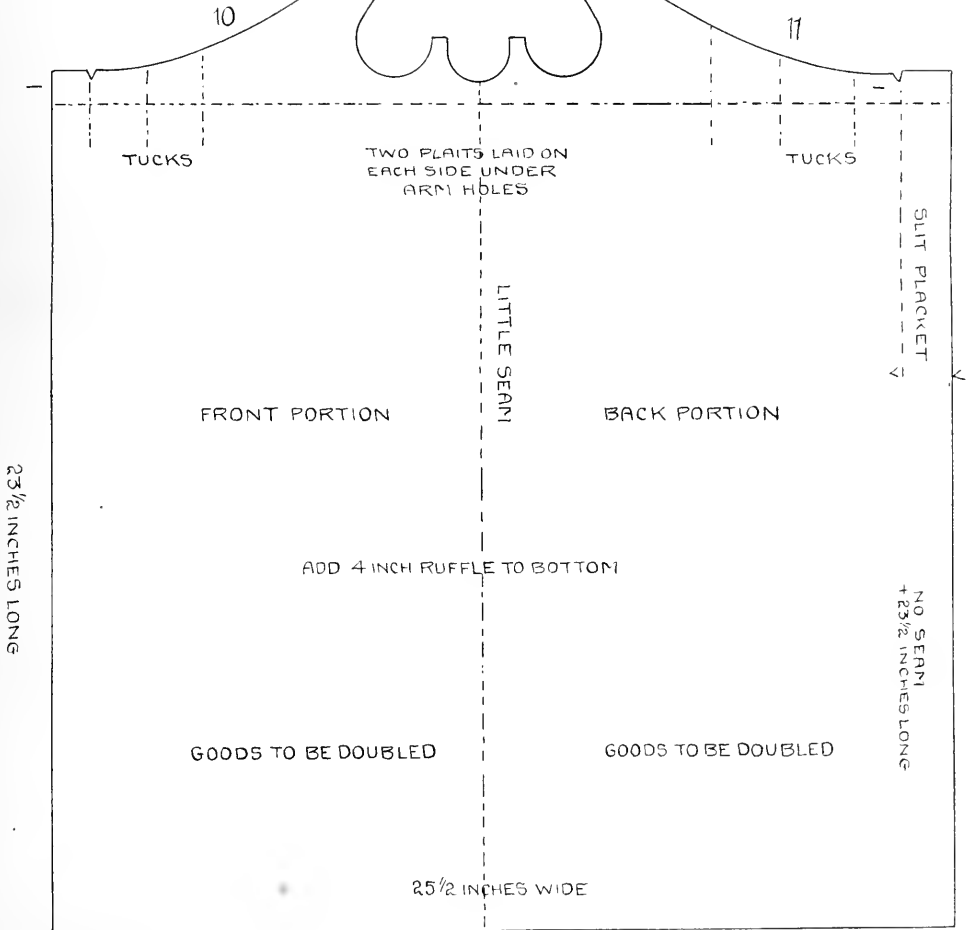

TT515
.K8

GIRLS BOX PLAIED SAILOR DRESS BUST 28 INCHES
AGE 10-12 YEARS

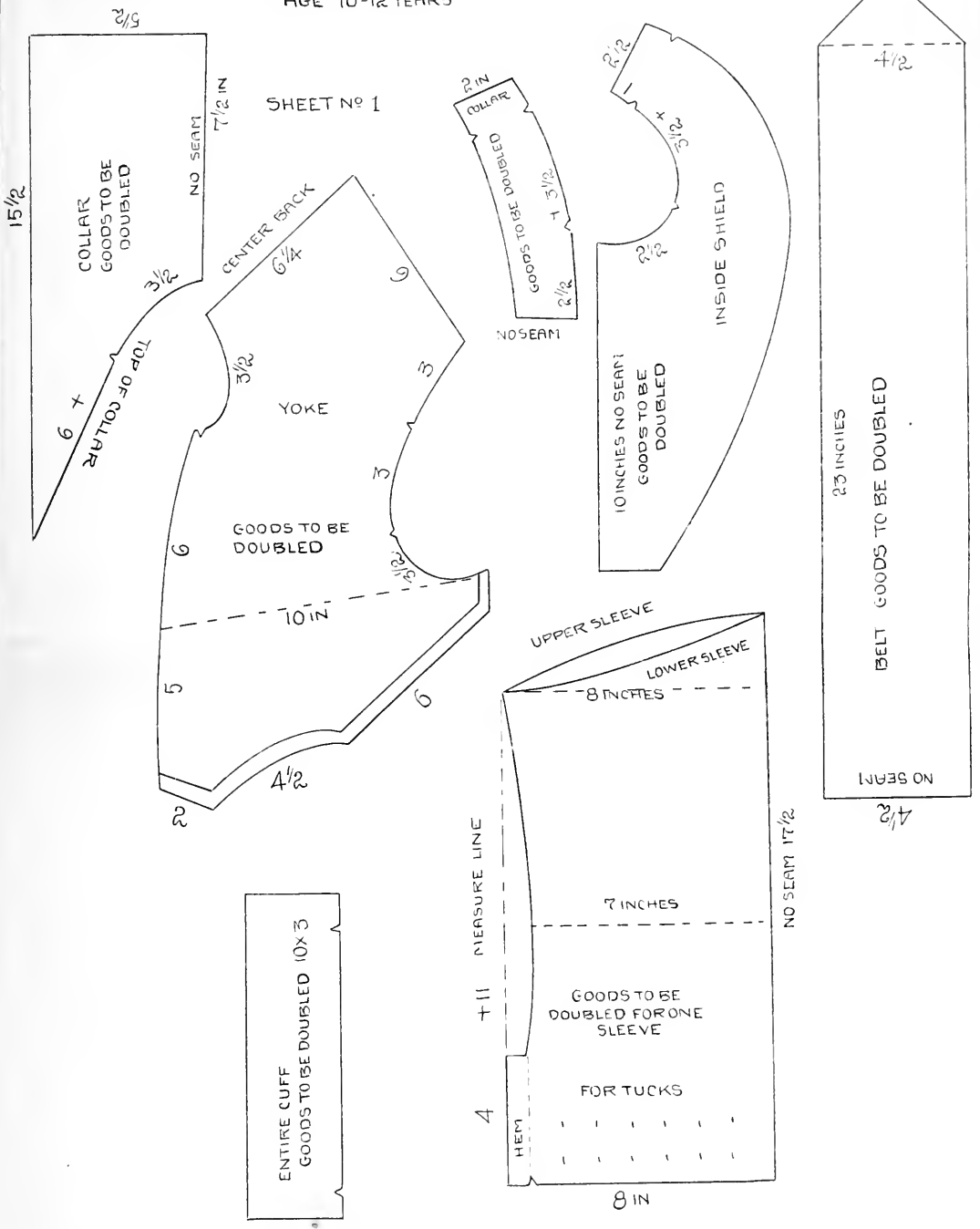

DRAWN ACCORDING TO THE PRINCIPLES OF COPYRIGHTED MANUAL OF APPAREL DRAFTING AND SEWING BY MRS MATTIE G KUNZ

TT515
.K8

SHEET No 2

FRONT PORTION OF SAILOR DRESS TO BE SLIPPED ON OVER HEAD AND AND BE MADE WITH SETOVER YOKE OR WITHOUT YOKE

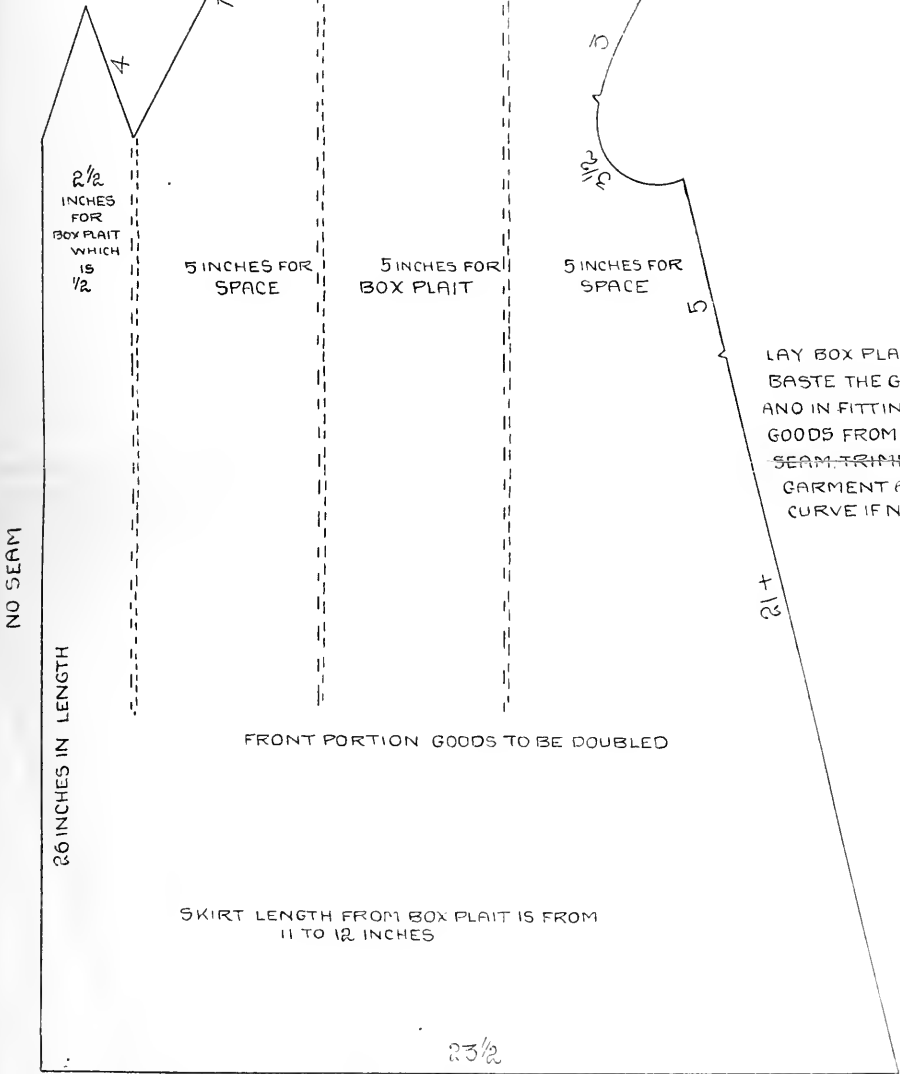

2 1/2 INCHES FOR BOX PLAITS WHICH IS 1/2

5 INCHES FOR SPACE

5 INCHES FOR BOX PLAITS

5 INCHES FOR SPACE

2 1/2

FRONT PORTION GOODS TO BE DOUBLED

SKIRT LENGTH FROM BOX PLAITS IS FROM 11 TO 12 INCHES

23 1/2

LAY BOX PLAITS FIRST AND BASTE THE GARMENT TOGETHER AND IN FITTING CUT THE SURPLUS GOODS FROM THE UNDER ARM SEAM TRIMMING OFF THE GARMENT AROUND THE ARM CURVE IF NEEDED

DRAWN ACCORDING TO THE PRINCIPLES OF COPYRIGHTED MANUAL OF APPAREL DRAFTING AND SEWING BY

MRS MATTIE G KUNZ

TT515
.K8

BACK PORTION OF
SAILOR DRESS.
TO BE MADE WITH OR WITHOUT
YOKE

SHEET N° 3

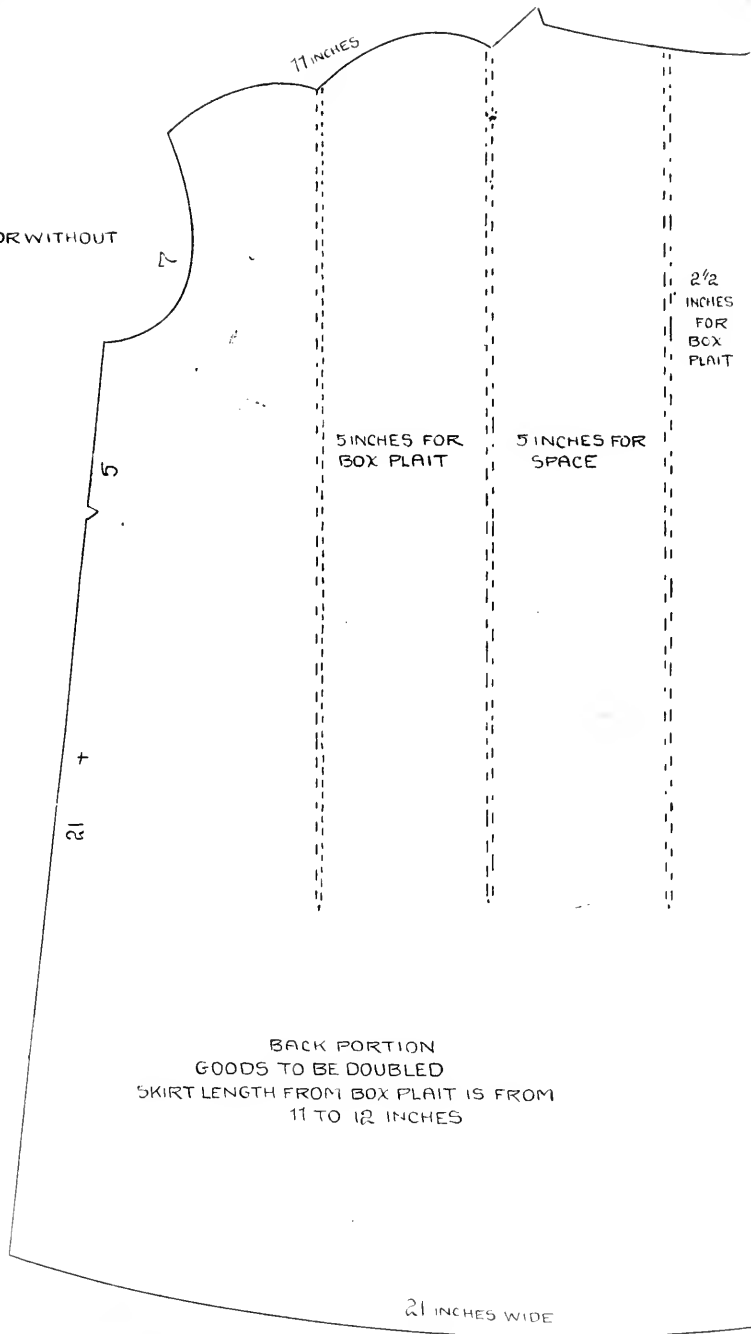

DRAWN ACCORDING TO THE PRINCIPLES OF COPYRIGHTED MANUAL OF APPAREL
DRAFTING AND SEWING BY
MRS MATTIE G KUNZ

TT515
.K8

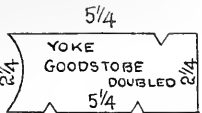

BOYS BLOUSE

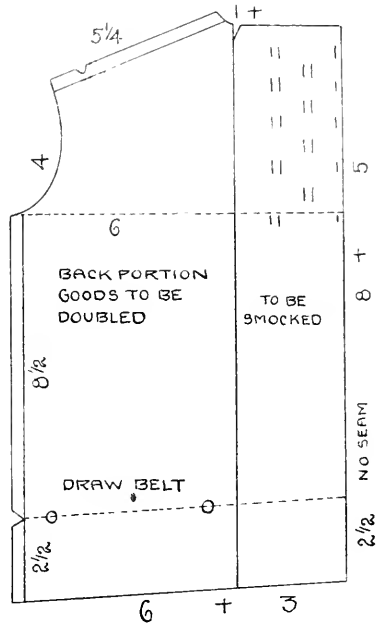
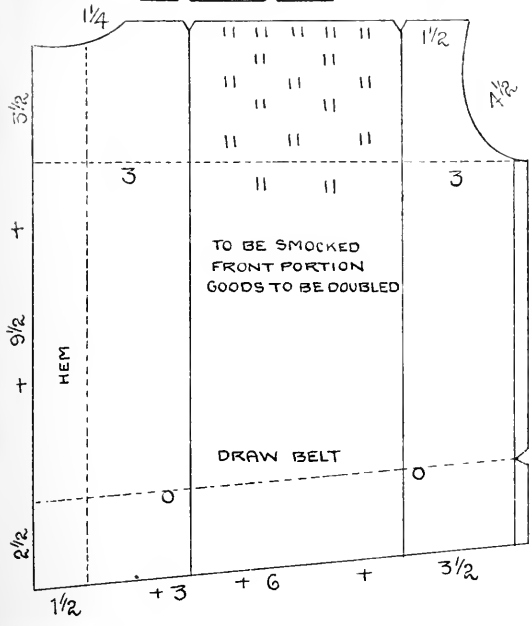

SLEEVE

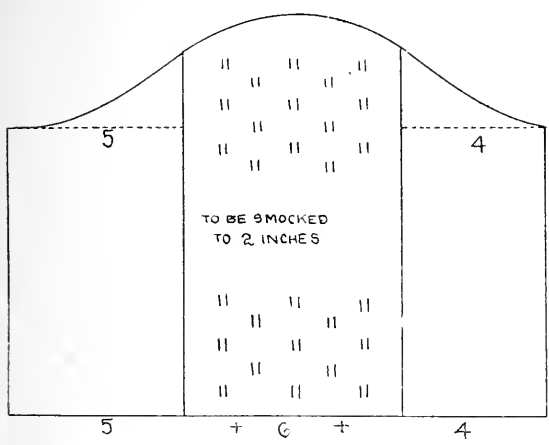

COLLAR

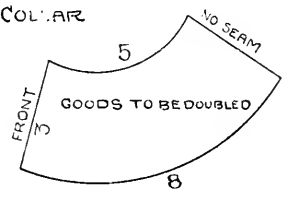

SMOCKING:

CREASE FOR 6 SMALL TUCKS, STITCHING 1ST AND 2ND TUCKS TOGETHER AND 3RD AND 4TH TOGETHER AND 5TH AND 6TH TOGETHER IN A STRAIGHT LINE ACROSS AND STITCH 2ND AND 3RD TUCKS TOGETHER, 4TH AND 5TH TOGETHER, ABOUT 1/2 AN INCH BELOW FIRST 3 CAUGHTS, AS MARKS INDICATE. REPEAT 1ST AND 2ND METHODS CONTINUING DOWNWARD TO THE DESIRED LENGTH, OR THE BLOUSE AND SLEEVE MAY BE TUCKED, AS PREFERRED.

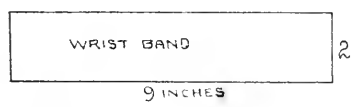

BLOUSE FRONT PORTION	BLOUSE BACK PORTION
CENTER FRONT . . . 15 IN.	BACK LENGTH . . . 15 1/2 IN.
FRONT NECK, INCLUDING YOKE . . . 3 1/2 IN.	NECK, INCLUDING SMOCKING . . . 1 1/2 IN.
(ENTIRE NECK) . . . 11 IN.	BUST . . . 16 IN.
BUST . . . 6 IN.	SHOULDER LENGTH . . . 5 1/4 IN.
(ENTIRE BUST) . . . 24 IN.	ARM HOLE . . . 4 IN.
SHOULDER LENGTH . . . 5 1/4 IN.	UNDER ARM . . . 8 1/2 IN.
ARM HOLE . . . 6 3/4 IN.	WRIST . . . 6 IN.
UNDER ARM . . . 8 1/2 IN.	BOTTOM BLOUSE . . . 9 IN.
WRIST . . . 6 IN.	
(ENTIRE WRIST) . . . 24 IN.	
BOTTOM BLOUSE . . . 14 IN.	

TT515
.K8

Little Boy's Breeches. Age 2 years.

These two pattern portions are to be joined together to make one leg. Notches show where to join.

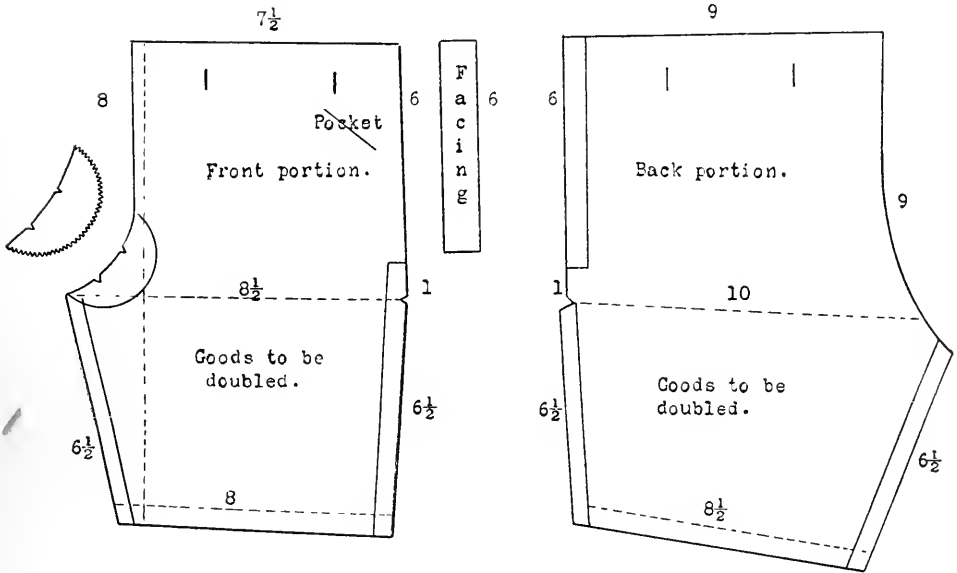

Measurements:

Front foundation line 13 inches.

Side length -- $13\frac{1}{2}$ inches.

Join the two center fronts with seam.

Join the two center backs with seam.

Work four button-holes at the front, also work four button-holes at the back.

Drawn according to the principles of copyrighted Manual of Apparel Drafting and Sewing,

by

Mrs. Mattie G. Kunz.

TT515
.K8

MENS COAT FRONT PORTION

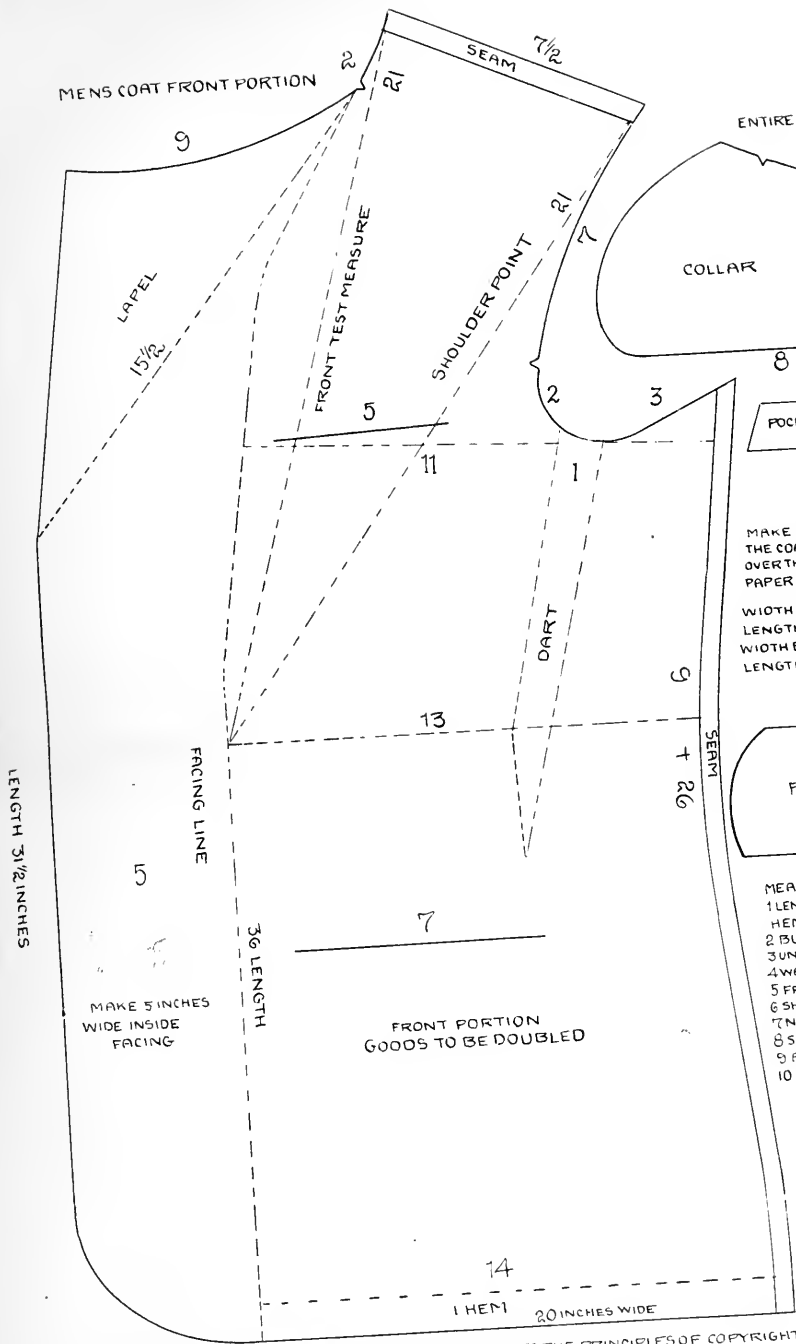

ENTIRE BUST 44 IN

COLLAR

POCKET WELT

POCKET LAP

MAKE LINING FOR THE FACING AND FOR THE COAT BY USING A TRACING WHEEL OVER THE DRAFTING, FIRST PLACING PLAIN PAPER UNDERNEATH THE DRAFTING

- WIDTH FRONT FACING 5 IN
- LENGTH FRONT FACING 3 1/2 IN
- WIDTH BOTTOM FACING 1 IN
- LENGTH BOTTOM FACING 20 IN

MEASUREMENTS FOR FRONT PORTION

- 1 LENGTH OF FRONT, INCLUDING BOTTOM HEM 36 IN
- 2 BUST 44 IN
- 3 UNDER ARM 5 IN
- 4 WAIST 13 IN
- 5 FRONT TEST MEASURE 21 IN
- 6 SHOULDER POINT 11 IN
- 7 NECK CURVE 7 1/2 IN
- 8 SHOULDER IN LENGTH 12 IN
- 9 ARM CURVE 14 IN
- 10 COAT BOTTOM WIDTH

FRONT PORTION GOODS TO BE DOUBLED

1 HEM 20 INCHES WIDE

FRONT PORTION OF MENS COAT, DRAWN ACCORDING TO THE PRINCIPLES OF COPYRIGHTED MANUAL OF APPAREL DRAFTING AND SEWING BY MRS MATTIE G KUNZ

LENGTH 31 1/2 INCHES

36 LENGTH

FACING LINE

LAPTEL 15 1/2

9

FRONT TEST MEASURE

SHOULDER POINT

DART

SEAM

14

TT515
.K8

MEN'S COAT BACK PORTION

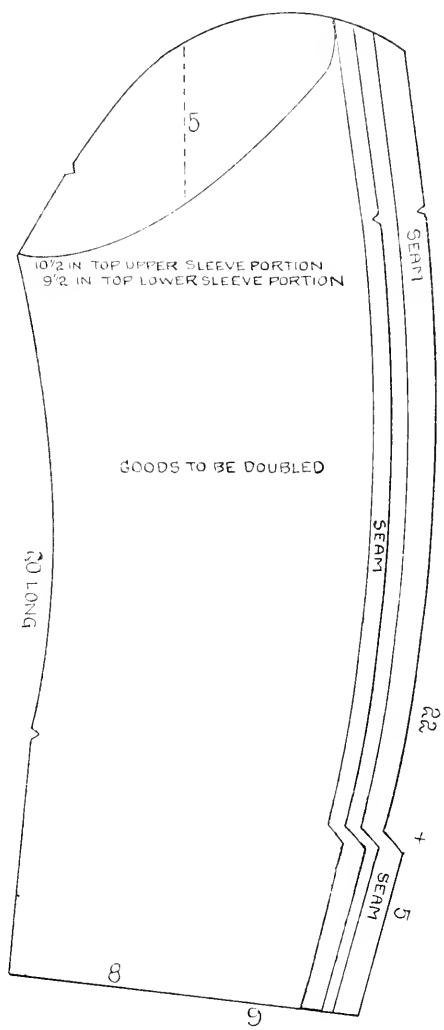
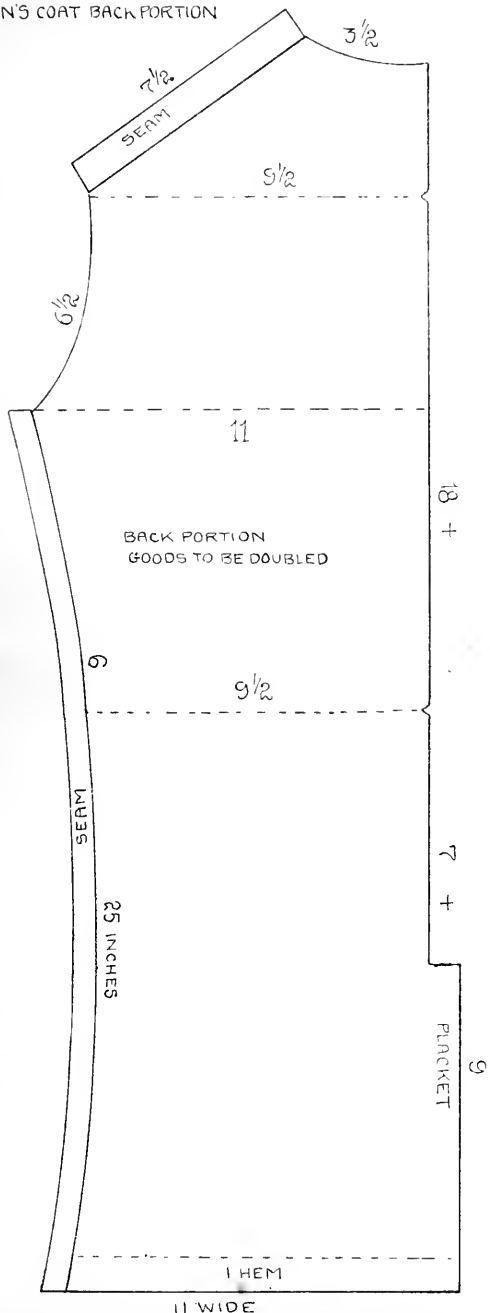

MEASUREMENTS FOR BACK PORTION

1	LENGTH OF CENTER BACK INCLUDING BOTTOM FACING OR HEM.....	34 IN.
2	BUST.....	11 IN.
3	UNDERARM.....	9 IN.
4	WAIST.....	9 1/2 IN.
5	NECK.....	3 1/2 IN.
6	WIDTH OF BACK.....	9 1/2 IN.
7	SHOULDER LENGTH.....	7 1/2 IN.
8	ARM CURVE.....	6 1/2 IN.
9	COAT BOTTOM WIDTH INCLUDING INCH FOR PLACKET.....	11 IN.

TT515
.K8

MEASUREMENTS BACK PORTION

MENS VEST

- 1 LENGTH OF BACK INCLUDING 3 IN BOTTON CURVE FACING 20 1/2
- 2 BUST.....11 IN
- 3 UNDER ARM.....8 IN
- 4 WAIST.....10 IN
- 5 NECK.....3 1/2 IN
- 6 WIDTH OF BACK.....9 1/2 IN
- 7 SHOULDER LENGTH.....7 IN
- 8 ARM CURVE.....9 1/2 IN
- 9 VEST BOTTOM.....11 IN

ENTIRE BUST 44 IN.

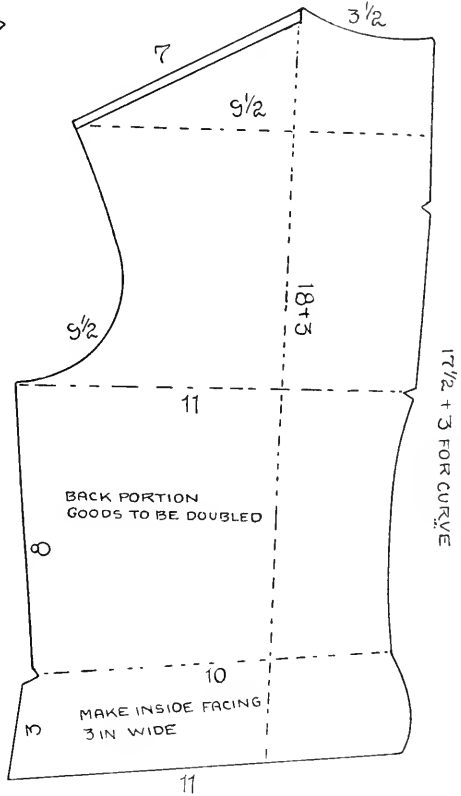
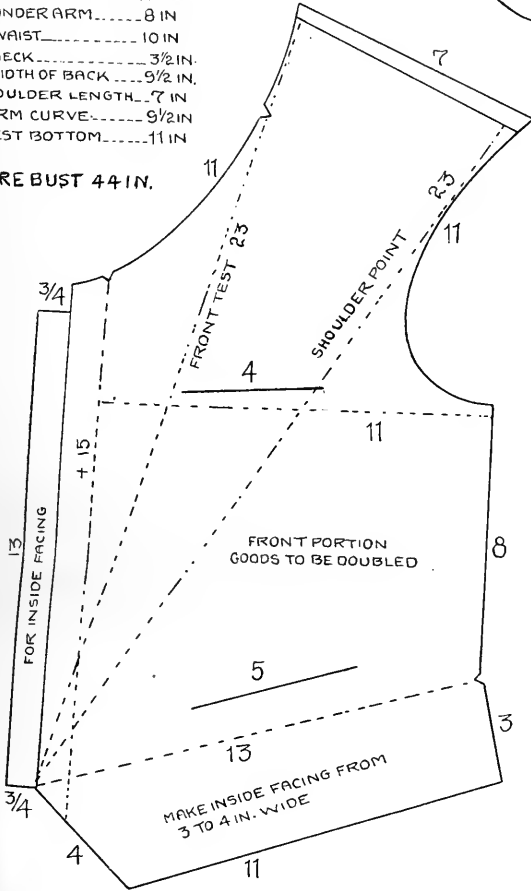
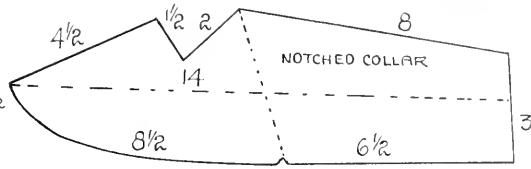

MEASUREMENTS FRONT PORTION

- 1 LENGTH OF FRONT.....15 IN.
- 2 BUST.....11 IN.
- 3 UNDER ARM.....8 IN.
- 4 WAIST.....13 IN.
- 5 FRONT TEST MEASURE.....23 IN.
- 6 SHOULDER POINT.....23 IN.
- 7 NECK CURVE.....11 IN.
- 8 SHOULDER LENGTH.....7 IN.
- 9 ARM CURVE.....11 IN.

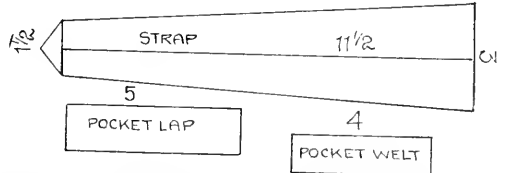

MAKE THE LINING FOR THE FACING AND FOR THE VEST BY USING A TRACING WHEEL OVER THE DRAFTING, FIRST PLACING PLAIN PAPER UNDERNEATH DRAFTING.
MENS VEST DRAWN ACCORDING TO THE PRINCIPLES OF COPYRIGHTED MANUAL OF APPAREL DRAFTING AND SEWING BY MRS MATTIE G. KUNZ

TT515
.K8

Men's pants.
 Waist measure -- 38 inches.
 Length of pants -- 45 "
 Center front -- $13\frac{1}{2}$ inches.
 Center back -- 19 "
 Entire hip for one leg
 measuring from a point 12
 inches down -- 30 inches.
 Knee-- 22 in. Ankle - $19\frac{1}{2}$ in.

Drawn on a scale of one-eighth of an inch to
 represent an inch, which suits the size of
 this book. Drawn according to the principles
 of copyrighted Manual of Apparel Drafting and
 Sewing, by

Mrs. Mattie G. Kunz.

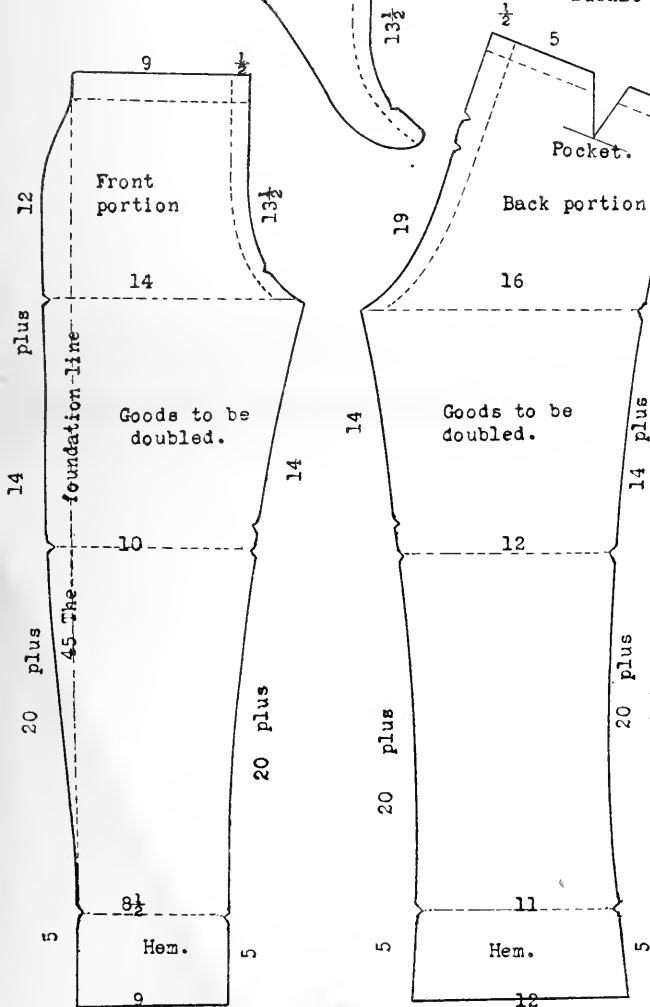
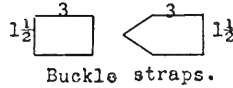
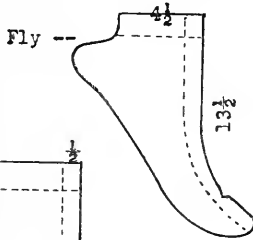
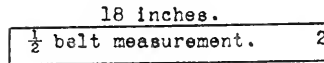

Measurements for pants.
 Take waist measure around
 the body at waist over
 pants and under vest;
 waistline is just above
 hip bones. Also take
 side length of pants from
 side waist measure to de-
 sired length of pants; also
 take the measurement of
 widest as well as the most
 narrow portion of the leg.
 Take knee measurement. Also
 take measurement from center
 front waist measure down to
 top inside leg pants' seam,
 and also take measure from
 this top inside leg pants' seam
 down close to the heel of the
 shoe. Also take measure from
 back center waist to top inside
 leg pants' seam. The front
 portion of men's pants is drawn
 about 2 inches smaller than the
 back portion. In making, sew
 four straps to top of pants to
 hold belt; also sew buttons for
 suspenders, if desired. Make in-
 visible button holes on facing for
 upper left portion. Good pressing
 in pants' making is necessary, and
 the latest touch is a crease to be
 pressed in each center front por-
 tion and each center back portion.
 (All measurements, except waist
 measure are taken loosely, to al-
 low for movement of the body.)

Notches show where the pattern is to be joined together. Make pattern
 5 inches longer at bottom and about $1\frac{1}{2}$ inches wider than ankle measurement.

TT515
.K8

Bust 44 inches.
Neck 16 "

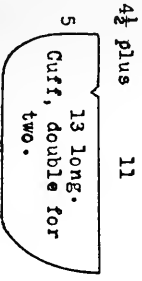
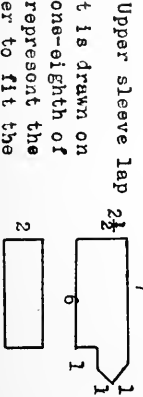
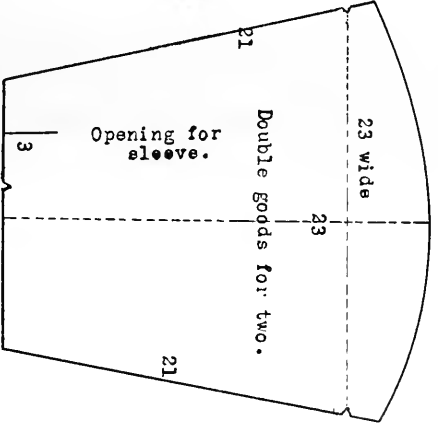
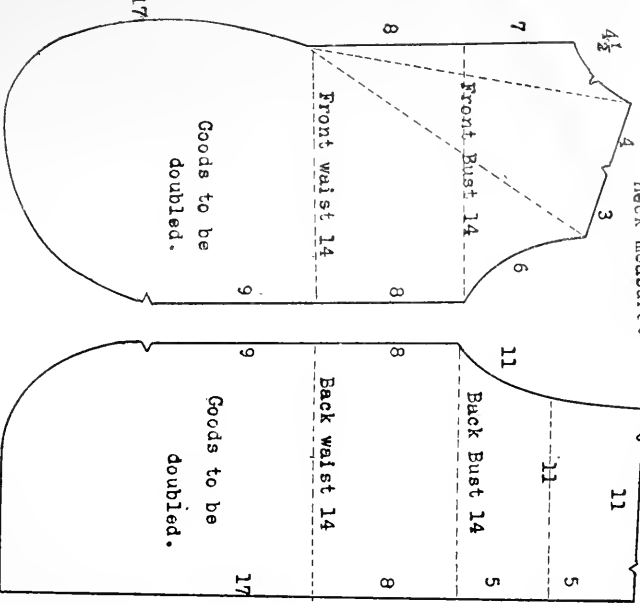
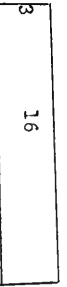
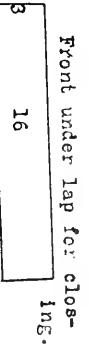
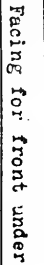
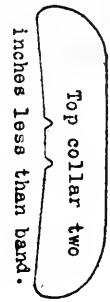
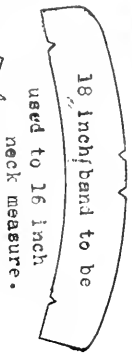

Front under Lap for closing. 16 ing.
Front over Lap for closing. 16 ing.

For sleeve measurements.

1. Take sleeve length measure from middle of back (between shoulder blades) to elbow with arm lifted, and again from middle of back to wrist, arm lifted and bent, two measurements being taken to make sure the sleeve is sufficiently long.
2. Take inside length of arm as shown -- 21 inches.
3. Take top of arm -- 23 inches.
4. Wrist, allowing fullness as shown -- 15 1/2 inches. Entire length being 21 plus 3 equals 24 inches.

This garment is drawn on a scale of one-eighth of an inch to represent the inch in order to fit the size of this book; the 1/4 inch is best for study purposes. Drawn according to the principles of copyright Manual of Apparel Drafting and Sewing, by Mrs. Mattie G. Kunz.

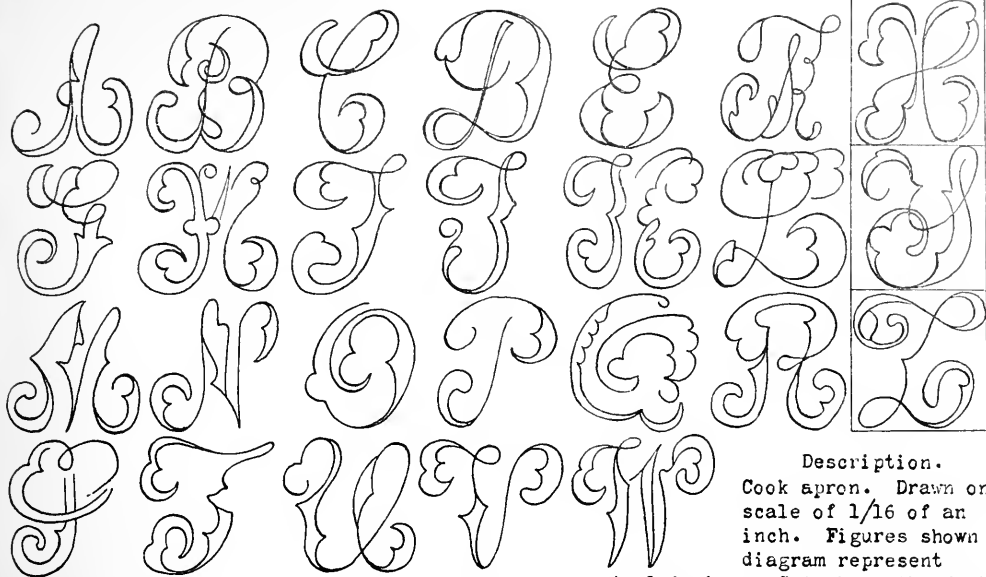

Description.

Cook apron. Drawn on a scale of 1/16 of an inch. Figures shown on diagram represent

actual inches. Cut where the dash lines are shown, to give extra fullness. Fold on the crosswise of the goods and fold it so as to get the length of the garment. Fold again in the center of lengthwise of the goods which makes no seam on the shoulder or front or back. If opening is desired on the side (as shown on diagram) use a tracing wheel to extract the pattern for the overlap, and cut to come on the left side, place small pocket on the right side, and large pocket on right side of apron-skirt. Place two half inch pleats at top center back neck if opening is made on the side, or make opening in the back if desired. Make seams on each side. Neck measure is drafted by circumference method, $2\frac{1}{2}$ being the radius in this case. Goods 46 inches wide will make the neatest garment, having no gore to add in the goods of the

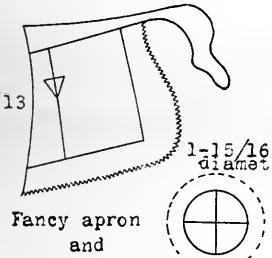

Fancy apron and Sweeping cap.
 Head measure $23\frac{1}{2}$ inches, which must equal the circumference.
 $\frac{1}{3}$ of $23\frac{1}{2}$ equals $7\frac{5}{6}$ the diameter, on the $\frac{1}{4}$ inch basis scale;
 $\frac{1}{2}$ of $7\frac{5}{6}$ equals $3\frac{11}{12}$ on the $\frac{1}{8}$ inch basis scale;
 $\frac{1}{2}$ of $3\frac{11}{12}$ equals $1\frac{23}{24}$ or 1 and $\frac{15}{16}$ of an inch on the $\frac{1}{16}$ inch basis scale.

Band for cap.
 $\frac{1}{2}$ of band equals $11\frac{3}{4}$ inches. By the $\frac{1}{16}$ inch scale, it is $2\frac{15}{16}$ as here shown.

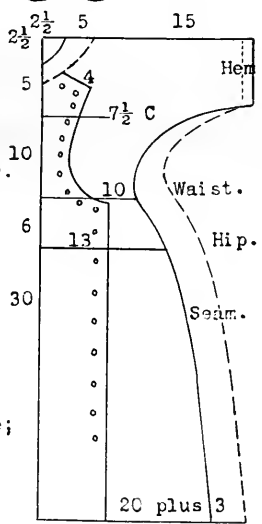

apron-skirt. If the goods is white make drafting on it without a pattern except for the overlap, by simply using the figures on small diagram. The measurements are as follows: Neck 15 inches. Front chest 15. Waist 40. Hip 52. Skirt length 36. Entire bottom being 92 inches. $\frac{1}{4}$ of bottom equals 20 plus 3 inches. Drawn according to the principles of copyrighted Manual of Apparel Drafting and Sewing, by Mrs. Mattie G. Kunz, Washington, D. C.

TT515
.K8

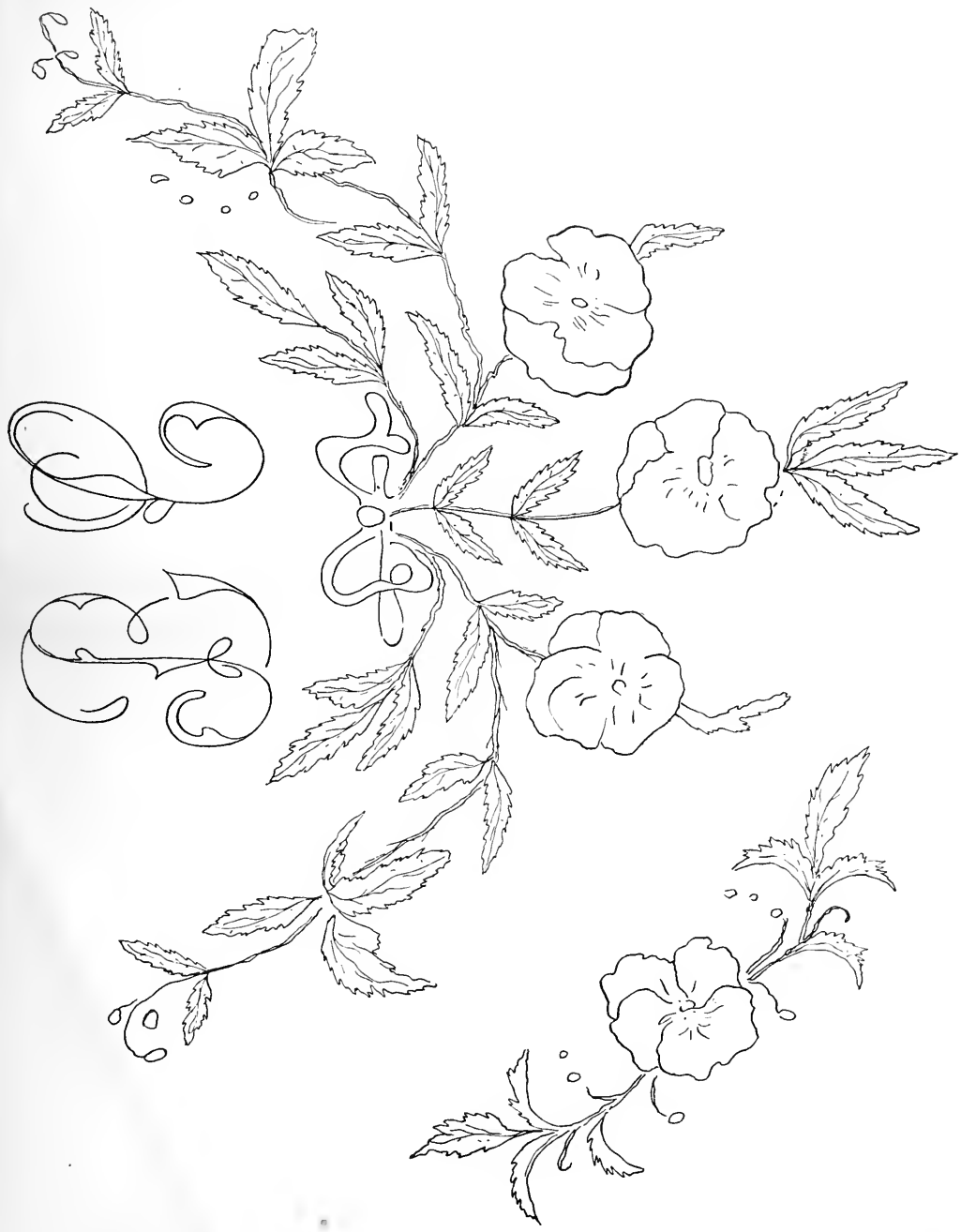

TT515
.K8

Observe that in this Manual measurements are taken according to an Order of Measurements, and are seldom taken in larger fractions than $1/4$, $1/2$, and $3/4$ of an inch, but calculations are made resulting in the form of $1/8$, $1/4$, $1/3$, $1/2$, $3/4$, and sometimes $1/16$ of an inch, as the American inch divides into 16 equal parts, thus enabling one to draw easily miniature methodical patterns. But when a calculation runs into thirds, or any uneven number--for instance take $1/3$ of an inch-- $1/3$ of an inch is $5-1/3/16$ of an inch, whereas $5/16$ of an inch is only $5/16$ of an inch and not quite $1/3$ of an inch, then one should, with a sharp pencil, make the nearest properly located point between one of the four spaces that is shown on the $1/4$ inch basis implement inclosed in the pocket of this book.

Many advantages are claimed for the Metric System, but the American inch is most suited for garment drafting on the $1/4$ and $1/2$ inch basis plan. For example, $1/4$ of an inch is equal to a little over 6 millimeters, as about 25 millimeters is equal to the American inch. $1/2$ of an inch is equal to a little over 12 millimeters. As there are 10 millimeters to a centimeter, it is apparent that it would be difficult to make a $1/4$ centimeter basis implement. The yard equals 36 inches and the meter equals 39.37 inches. The linear measure of the Metric System is as follows: 10 millimeters equals 1 centimeter, 10 centimeters equals 1 decimeter, 10 decimeters equals 1 meter, 10 meters equals 1 dekameter, 10 dekameters equals 1 hectometer, 10 hectometers equals 1 kilometer.

The following scale shows the portions of the inch that are readily used:

-----,-----,-----,-----,-----,-----
 $1/16$ $1/8$ $1/4$ $1/3$ $1/2$ $3/4$

To the apt dressmaker, the small methodical pattern drawn on the $1/4$ inch basis plan is sufficient aid to cut the cloth for a full size garment. To do this, first stretch a cloth over the cutting table and fasten it, so that the goods may be pinned to it now and then, and use pins, chalk, red or blue pencil, or a few basting stitches with white or black thread, as the goods would indicate, following the figures on the small model, and observing to double the cloth when necessary. But if a large size pattern is desired, use an ordinary ruler (or yardstick for skirt), and the large size curvature, following the full inch procedure in the book, or if the small size pattern is already drafted, use the same figures thereon to produce the full size pattern.

Another advantage in using the $1/4$ inch basis implement model work as a guide in the manner indicated above is that where there is a design or stripe in the goods one may observe better how to keep the design or stripe in its proper position while cutting out the cloth.

TT515
· K8

MEASURE
BOOK

Name

Residence

**Order of measurements for the easy
drafting solution.**

Basque

- 1 Length of back.....
- 2 Under-arm
- 3 Bust.....
- 4 Neck
- 5 Width of back.....
- 6 Shoulder in length.....
- 7 Waist.....
- 8 Entire front measure.....
- 9 Width of chest
- 10 Shoulder line.....
- 11 Shoulder point.....
- 12 Front test measure.....
- 13 Around the form over the hips...

Sleeve

- 1 Take inside length of arm at front.
- 2 Top of arm around it.....
- 3 From $\frac{2}{3}$ the way from inside length
of arm measure on top of arm
measure up to the end of shoul-
der point measure, as shown by
dotted line on diagram.....
- 4 Elbow, around it.....
- 5 Wrist, around it.....

Skirt

- 1 Around the waist at belt line.....
- 2 Around the hips.....
- 3 Down front the desired length...
- 4 Down back the desired length....
- 5 Down side over the hips.....

Name.....

Residence.....

Order of measurements for the advanced course.

Basque

1 Length of back.....

2 Under-arm.....

3 Bust measure.....

4 Arm-hole.....

5 Arm-curve of arm-hole.....

This measure is solved arithmetically, in the progress of the drafting.....

6 Width of back.....

7 Shoulder in length.....

8 Neck measure.....

9 Waist Measure.....

10 Width of chest.

11 Entire front measure.....

12 Shoulder line.....

13 Shoulder point.....

(Remember shoulder in length, shoulder line, and shoulder point are three separate order of measurements).

14 Front test measure.....

15 Hip measure. around the form in adults, about six inches below the waist line.....

Sleeve

1 Take inside length of arm at front

2 Top of arm around it.....

3 From $\frac{2}{3}$ the way from inside length of arm on top of arm measure, as shown by dotted line on diagram.....

4 Elbow, around it.....

5 Wrist, around it.....

Skirt

1 Around the waist at belt line.....

2 Around the hips.....

3 Down front the desired length....

4 Down back the desired length....

5 Down side over the hips.....

Name

Residence

**Order of measurements for the easy
drafting solution.**

Basque

- 1 Length of back.....
- 2 Under-arm
- 3 Bust.....
- 4 Neck
- 5 Width of back.....
- 6 Shoulder in length.....
- 7 Waist.....
- 8 Entire front measure.....
- 9 Width of chest
- 10 Shoulder line.....
- 11 Shoulder point.....
- 12 Front test measure.....
- 13 Around the form over the hips...

Sleeve

- 1 Take inside length of arm at front.
- 2 Top of arm around it.....
- 3 From $\frac{2}{3}$ the way from inside length of arm measure on top of arm measure up to the end of shoulder point measure, as shown by dotted line on diagram.....
- 4 Elbow, around it.....
- 5 Wrist, around it.....

Skirt

- 1 Around the waist at belt line.....
- 2 Around the hips.....
- 3 Down front the desired length...
- 4 Down back the desired length....
- 5 Down side over the hips.....

Name.....

Residence.....

Order of measurements for the advanced course.

Basque

1 Length of back.....

2 Under-arm.....

3 Bust measure.....

4 Arm-hole.....

5 Arm-curve of arm-hole.....

This measure is solved arithmetically, in the progress of the drafting.....

6 Width of back.....

7 Shoulder in length.....

8 Neck measure.....

9 Waist Measure.....

10 Width of chest.

11 Entire front measure.....

12 Shoulder line.....

13 Shoulder point.....

(Remember shoulder in length, shoulder line, and shoulder point are three separate order of measurements).

14 Front test measure.....

15 Hip measure, around the form in adults, about six inches below the waist line.....

Sleeve

1 Take inside length of arm at front

2 Top of arm around it.....

3 From $\frac{2}{3}$ the way from inside length of arm on top of arm measure, as shown by dotted line on diagram.....

4 Elbow, around it.....

5 Wrist, around it.....

Skirt

1 Around the waist at belt line....

2 Around the hips.....

3 Down front the desired length....

4 Down back the desired length....

5 Down side over the hips.....

Name
Residence

**Order of measurements for the easy
drafting solution.**

Basque

- 1 Length of back.....
- 2 Under-arm
- 3 Bust.....
- 4 Neck
- 5 Width of back.....
- 6 Shoulder in length.....
- 7 Waist.....
- 8 Entire front measure.....
- 9 Width of chest
- 10 Shoulder line.....
- 11 Shoulder point.....
- 12 Front test measure.....
- 13 Around the form over the hips...

Sleeve

- 1 Take inside length of arm at front.
- 2 Top of arm around it.....
- 3 From $\frac{2}{3}$ the way from inside length
of arm measure on top of arm
measure up to the end of shoul-
der point measure, as shown by
dotted line on diagram.....
- 4 Elbow, around it.....
- 5 Wrist, around it.....

Skirt

- 1 Around the waist at belt line.....
- 2 Around the hips.....
- 3 Down front the desired length...
- 4 Down back the desired length....
- 5 Down side over the hips.....

Name.....

Residence.....

Order of measurements for the advanced course.

Basque

- 1 Length of back.....
- 2 Under-arm.....
- 3 Bust measure.....
- 4 Arm-hole.....
- 5 Arm-curve of arm-hole.....
This measure is solved arithmetically, in the progress of the drafting.....
- 6 Width of back.....
- 7 Shoulder in length.....
- 8 Neck measure.....
- 9 Waist Measure.....
- 10 Width of chest.
- 11 Entire front measure.....
- 12 Shoulder line.....
- 13 Shoulder point.....
(Remember shoulder in length, shoulder line, and shoulder point are three separate order of measurements).
- 14 Front test measure.....
- 15 Hip measure. around the form in adults, about six inches below the waist line.....

Sleeve

- 1 Take inside length of arm at front
- 2 Top of arm around it.....
- 3 From $\frac{2}{3}$ the way from inside length of arm on top of arm measure, as shown by dotted line on diagram.....
- 4 Elbow, around it.....
- 5 Wrist, around it.....

Skirt

- 1 Around the waist at belt line.....
- 2 Around the hips.....
- 3 Down front the desired length....
- 4 Down back the desired length....
- 5 Down side over the hips.....

Name

Residence

**Order of measurements for the easy
drafting solution.**

Basque

- 1 Length of back.....
- 2 Under-arm
- 3 Bust.....
- 4 Neck
- 5 Width of back.....
- 6 Shoulder in length.....
- 7 Waist.....
- 8 Entire front measure.....
- 9 Width of chest
- 10 Shoulder line.....
- 11 Shoulder point.....
- 12 Front test measure.....
- 13 Around the form over the hips...

Sleeve

- 1 Take inside length of arm at front.
- 2 Top of arm around it.....
- 3 From $\frac{2}{3}$ the way from inside length
of arm measure on top of arm
measure up to the end of shoul-
der point measure, as shown by
dotted line on diagram.....
- 4 Elbow, around it.....
- 5 Wrist, around it.....

Skirt

- 1 Around the waist at belt line.....
- 2 Around the hips.....
- 3 Down front the desired length...
- 4 Down back the desired length....
- 5 Down side over the hips.....

Name.....

Residence.....

Order of measurements for the advanced course.

Basque

1 Length of back.....

2 Under-arm.....

3 Bust measure.....

4 Arm-hole.....

5 Arm-curve of arm-hole.....

This measure is solved arithmetically, in the progress of the drafting.....

6 Width of back.....

7 Shoulder in length.....

8 Neck measure.....

9 Waist Measure.....

10 Width of chest.

11 Entire front measure.....

12 Shoulder line.....

13 Shoulder point.....

(Remember shoulder in length, shoulder line, and shoulder point are three separate order of measurements).

14 Front test measure.....

15 Hip measure, around the form in adults, about six inches below ist line.....

Sleeve

1 Take inside length of arm at front

2 Top of arm around it.....

3 From $\frac{2}{3}$ the way from inside length of arm on top of arm measure, as shown by dotted line on diagram.....

4 Elbow, around it.....

5 Wrist, around it.....

Skirt

1 Around the waist at belt line.....

2 Around the hips.....

3 Down front the desired length....

4 Down back the desired length....

5 Down side over the hips.....

Name

Residence

**Order of measurements for the easy
drafting solution.**

Basque

- 1 Length of back.....
- 2 Under arm
- 3 Bust.....
- 4 Neck
- 5 Width of back.....
- 6 Shoulder in length.....
- 7 Waist.....
- 8 Entire front measure.....
- 9 Width of chest
- 10 Shoulder line.....
- 11 Shoulder point.....
- 12 Front test measure.....
- 13 Around the form over the hips...

Sleeve

- 1 Take inside length of arm at front.
- 2 Top of arm around it.....
- 3 From ²/₃ the way from inside length
of arm measure on top of arm
measure up to the end of shoul-
der point measure, as shown by
dotted line on diagram.....
- 4 Elbow, around it.....
- 5 Wrist, around it.....

Skirt

- 1 Around the waist at belt line.....
- 2 Around the hips.....
- 3 Down front the desired length...
- 4 Down back the desired length....
- 5 Down side over the hips.....

Name.....

Residence.....

Order of measurements for the advanced course.

Basque

1 Length of back.....

2 Under-arm.....

3 Bust measure.....

4 Arm-hole.....

5 Arm-curve of arm-hole.....

This measure is solved arithmetically, in the progress of the drafting.....

6 Width of back.....

7 Shoulder in length.....

8 Neck measure.....

9 Waist Measure.....

10 Width of chest.

11 Entire front measure.....

12 Shoulder line.....

13 Shoulder point.....

(Remember shoulder in length, shoulder line, and shoulder point are three separate order of measurements).

14 Front test measure.....

15 Hip measure, around the form in adults, about six inches below ist line.....

Sleeve

1 Take inside length of arm at front

2 Top of arm around it.....

3 From $\frac{2}{3}$ the way from inside length of arm on top of arm measure, as shown by dotted line on diagram.....

4 Elbow, around it.....

5 Wrist, around it.....

Skirt

1 Around the waist at belt line.....

2 Around the hips.....

3 Down front the desired length.....

4 Down back the desired length.....

5 Down side over the hips.....

Name

Residence

**Order of measurements for the easy
drafting solution.**

Basque

- 1 Length of back.....
- 2 Under-arm
- 3 Bust.....
- 4 Neck
- 5 Width of back.....
- 6 Shoulder in length.....
- 7 Waist.....
- 8 Entire front measure.....
- 9 Width of chest
- 10 Shoulder line.....
- 11 Shoulder point.....
- 12 Front test measure.....
- 13 Around the form over the hips...

Sleeve

- 1 Take inside length of arm at front.
- 2 Top of arm around it.....
- 3 From $2\frac{3}{4}$ the way from inside length
of arm measure on top of arm
measure up to the end of shoul-
der point measure, as shown by
dotted line on diagram.....
- 4 Elbow, around it.....
- 5 Wrist, around it.....

Skirt

- 1 Around the waist at belt line.....
- 2 Around the hips.....
- 3 Down front the desired length...
- 4 Down back the desired length....
- 5 Down side over the hips.....

Name.....

Residence.....

Order of measurements for the advanced course.

Basque

- 1 Length of back
- 2 Under-arm.....
- 3 Bust measure.....
- 4 Arm-hole
- 5 Arm-curve of arm-hole
- This measure is solved arithmetically, in the progress of the drafting
- 6 Width of back.....
- 7 Shoulder in length.....
- 8 Neck measure
- 9 Waist Measure.....
- 10 Width of chest.
- 11 Entire front measure.....
- 12 Shoulder line
- 13 Shoulder point.....
 (Remember shoulder in length, shoulder line, and shoulder point are three separate order of measurements).
- 14 Front test measure
- 15 Hip measure. around the form in adults, about six inches below ist line.....

Sleeve

- 1 Take inside length of arm at front
- 2 Top of arm around it.....
- 3 From $\frac{2}{3}$ the way from inside length of arm on top of arm measure, as shown by dotted line on diagram
- 4 Elbow, around it.....
- 5 Wrist, around it.....

Skirt

- 1 Around the waist at belt line....
- 2 Around the hips.....
- 3 Down front the desired length....
- 4 Down back the desired length....
- 5 Down side over the hips.....

Name

Residence

**Order of measurements for the easy
drafting solution.**

Basque

- 1 Length of back.....
- 2 Under-arm
- 3 Bust.....
- 4 Neck
- 5 Width of back.....
- 6 Shoulder in length.....
- 7 Waist.....
- 8 Entire front measure.....
- 9 Width of chest
- 10 Shoulder line.....
- 11 Shoulder point.....
- 12 Front test measure.....
- 13 Around the form over the hips...

Sleeve

- 1 Take inside length of arm at front.
- 2 Top of arm around it.....
- 3 From $\frac{2}{3}$ the way from inside length
of arm measure on top of arm
measure up to the end of shoul-
der point measure, as shown by
dotted line on diagram.....
- 4 Elbow, around it.....
- 5 Wrist, around it.....

Skirt

- 1 Around the waist at belt line.....
- 2 Around the hips.....
- 3 Down front the desired length...
- 4 Down back the desired length....
- 5 Down side over the hips.....

Name.....

Residence.....

Order of measurements for the advanced course.

Basque

- 1 Length of back.....
- 2 Under-arm.....
- 3 Bust measure.....
- 4 Arm-hole.....
- 5 Arm-curve of arm-hole.....
This measure is solved arithmetically, in the progress of the drafting.....
- 6 Width of back.....
- 7 Shoulder in length.....
- 8 Neck measure.....
- 9 Waist Measure.....
- 10 Width of chest.
- 11 Entire front measure.....
- 12 Shoulder line.....
- 13 Shoulder point.....
(Remember shoulder in length, shoulder line, and shoulder point are three separate order of measurements).
- 14 Front test measure.....
- 15 Hip measure, around the form in adults, about six inches below ist line.....

Sleeve

- 1 Take inside length of arm at front
- 2 Top of arm around it.....
- 3 From $\frac{2}{3}$ the way from inside length of arm on top of arm measure, as shown by dotted line on diagram.....
- 4 Elbow, around it.....
- 5 Wrist, around it.....

Skirt

- 1 Around the waist at belt line....
- 2 Around the hips.....
- 3 Down front the desired length....
- 4 Down back the desired length....
- 5 Down side over the hips.....





This envelope pocket is made as a convenient place to keep the implements in good condition after they have been cut out of the cardboard, also the measure book. The large size paper curvature may be placed in the pocket after folding it.

If mucilage is put on the back of the large size paper curvature, a piece of paperhanger's canvas stretched over it, and when dry the canvas trimmed even with the curvature with scissors, it will prevent the curvature from getting torn.

Any paper patterns drafted and desired to be used frequently, or preserved, may also be strengthened in this way by the use of canvas.

LIBRARY OF CONGRESS



0 014 060 189 5