

ISSUE 44 OCTOBER 1993
ISSN 0959-2881

Knotting Matters

Newsletter of the



INTERNATIONAL
GUILD OF KNOT TYERS

GUILD SUPPLIES

I.G.K.T. PRICE LIST 1993

ITEM	WEIGHT	PRICE
POSTCARDS		
Set of 8 instructional (Brown & Cream)	35 gms	£1.50 (Set)
POSTCARDS		
Set of 8 Single Strand Ornamental Knots (White on Blue)	35 gms	£1.50 (Set)
TIES :		
Silk (Dark blue, with white Knot motifs)	30 gms LONG 30 gms BOW	£6.50 each £7.80 each
BADGES:		
Guild LOGO	5 gms	
Enamel Brooch Type		£1.80 each
Cloth, Blazer Type		£1.00 each
Car Sticker (Soft Plastic)		£1.00 each
3"(75mm) Pressed Printed Metal		£0.30 each
CHRISTMAS CARDS "A Star & A Crown"		
	40 gms	£3.00 for 10 (with envelopes)
T-SHIRT		
Size - XL	145 gms	£6.95 each
Size - L		

SUPPLIES SECRETARY

3 Walnut Tree Meadow

Stonham Aspal

STOWMARKET

Suffolk IP14 6DF

Tel: 0449 - 711121

KNOTTING MATTERS

THE QUARTERLY NEWSLETTER of
THE INTERNATIONAL GUILD OF KNOT TYERS
ISSUE No. 44 OCTOBER 1993

PRESIDENT

Glad FINDLEY

Hon. VICE PRESIDENT

Dr Vaughan JONES

PAST PRESIDENTS

Percy BLANDFORD - Geoffrey BUDWORTH - Eric FRANKLIN
- Jan VOS - Stuart GRAINGER -

GUILD ANNUAL SUBSCRIPTION RATES:
(RENEWABLE 1st JANUARY). PAYABLE By:
CASH/CHEQUE/EUROCARD/ MASTERCARD or
VISA.

Juniors (Under 16 years old).....£4.00
Seniors.....£14.00
Families.....£19.00
Corporate.....ByArrangement

Taxpayers in the UK - We would prefer a
covenanted subscription.

Except as otherwise indicated, copyright in Knotting
Matters is reserved to the International Guild of Knot
Tyers IGKT 1993. Copyright in members' articles
published in Knotting Matters is reserved to the
authors and permission to reprint should be sought
from the author and editor. All sources of
quotations printed in Knotting Matters are
acknowledged.

SECRETARY

Nigel HARDING
3 Walnut Tree Meadow
Stonham Aspal
STOWMARKET
Suffolk
IP14 6DF
Tel: 0449 - 711121

EDITOR

Gordon PERRY MBE
171 London Road
HORNDEAN
Hampshire
PO8 0HH
Tel: 0705 - 592808

The IGKT is a UK REGISTERED CHARITY #802153

From THE SECRETARY'S BLOTTER

Time seems to fly by these days, and already it's time for me to sit down and try to decipher some of those jottings I have made in the corner of the blotter. It would help if I could read my own writing, and it would be so much easier if I hadn't spilt quite so much tea on it!!

From the correspondence I have received during the summer, there has been a lot knotting going on all over the world, and the fruits of this great effort has been a general increase of awareness of the guild, and a gradual expansion of the membership. It is true that some members do fall by the wayside each year, especially in such time of economic depression, however the level of applications is now exceeding the number of resignations.

Over the last few weeks I have been passing the cold wet evenings by updating the Membership Directory which, by the time you are reading this, I hope that you will already have received your copy. Although it was hard work, it was interesting to see the spread of members, and also the number of local groups which are now beginning to evolve.

I will take this opportunity to apologise for any errors which may have crept in. I believe that they slip in during the night whilst the computer is switched off, a technical problem known in the trade as "Ionised Gremlins".

The most significant knotting event that I have attended recently was the October meeting at Pitsea, where we were guests

of the Essex branch, at the National Motorboat Museum. After the formalities and a splendid buffet lunch we went into the museum itself, where there were a number of active displays by members. The High Sherrif of Essex paid an official visit to the exhibition, together with a number of Local Councillors and their wives, all of whom were impressed with what they saw. On behalf of the Guild I would like to thank both the organisers and presenters for putting on such a splendid exhibition. As always, at the end of the day it proved almost impossible to prise the members out of the building. In an attempt to overcome this problem in future, the next AGM, which will be in Nottingham on the 7th May 94, will be spread over two days!

The Pitsea meeting also marked the publication of both KM43, and Much Ado About Knotting, the book by Geoffrey Budworth marking the tenth anniversary of the Guild, and recording the history of those first ten years. Our thanks go to Geoffrey for producing such a super little treasure. I must record my apologies to Geoffrey for not spotting the one or two typographical errors which mysteriously appeared, I hope you don't manage to spot them.

Just occasionally I receive a letter with a difference, such as the one from Pierre Petit, who joined recently. Unlike most of our members who work with rope, Pierre choses to walk on it, - usually hundreds of feet above the ground, as he is a "High

Wire Artist”.

Another letter is the one from Stephen Riley in Liverpool, who wants to test the “Strength of Knots” - by being tied up for a couple of hours to see if he can escape. Despite my discouragement he is still anxious to pursue this, and so if there are any members in the North West who would be prepared to assist with this dubious activity, please give me a ring, and I will pass on the details.

Finally, I must remind members that January is now upon us, and for many members that means that it is Subscription Time!! As yet I am not quite geared up to issue individual reminders, but hopefully that will be one of the projects for next year. Don't forget that credit card payments are by far the simplest, and cheapest method of payment if you are an overseas member.

Whilst I am always pleased to receive subscriptions, even when they are eleven months late, such as the one I received today, it does help considerably with the administrative work load if it arrives on time. On this point, there is some doubt as to the future of “Membership Cards”, as the work involved in issuing them this year was disproportionate with their worth, however...

I would like to wish you all a happy, knot tying 1994.

Nigel Harding

EDITORIAL

Firstly I would like to thank those of you that have sent me articles - particularly to Lesley WYATT for the index which is included in this edition - since my plea for help in KM43; alas still no black & white photographs though - I hope it is because you are all using colour or transparencies and not that you are failing to photograph your work because if you are not I can assure you, from bitter experience, that you will live to regret it.

If your article or letter does not appear in this edition don't worry as I have saved some for KM45.

I now have a date for retirement, so God willing, all things being equal, and peace in our land I will be a civilian on 18th June 1994. I do not plan to embark on another career, but doing a little part time consultancy work which allows me more time for my woodturning, knotting and I hope, having just invested in my own PC, continue as your editor.

No editorial of mine would be complete without asking for something so - is there anyone who could put together a crossword or two, related to knots and associated equipment for publication in KM?.

Finally may I wish you all the Seasons Greetings and a Happy New year.

DEFINITIONS

Rogue's Yarn: The distinctive yarn put in all navy rope to mark it as government rope. Portsmouth rope has a red yarn; Plymouth blue; Chatham yellow; and Haulbowline, black. All navy wire rope has a white jute in the hempen heart of the rope.

LETTERS

Richard HOPKINS writes.....

Have other members of the Guild discovered this small metal gadget for protecting the fingers?

I was in a private museum in Bristol and could not work out the function of the device. It was issued by a local stationer in the days when purchases were tied up with string. To prevent the string from cutting the fingers while carrying the purchases home the string was slipped into the 'U' shaped notch and the weight was thus spread over two fingers.

The museum proprietor had heard of a similar item given away by 'Bovril' to make carrying the large jars more comfortable. Presumably some form of bottle sling was tied around the neck of the jar and the cord then fitted in the carrying notch.

These devices were made of thin metal strip with the company name painted on.

oooOOOooo

In the Blaise Castle museum at Bristol there are two bone or ivory 'lucets'. These are what Ashley calls 'chain forks' (#2875). The luckets are described as being used domestically for making cord up to the end of the 18th century.

The cord was used extensively in most homes for fastening clothes, decorating cushions etc.

Instructions for use are given but I found them as hard to follow as those in Ashley.

The two lucets in the museum seem to

match the one described by Ashley from Miss Lambert's book of needlework as they are lyre shaped and without the shoulders shown in #2875.

oooOOOooo

During another idle moment in the library I was looking through the Dover reprint of Diderot's Pictorial Encyclopedia of Trade and Industry, for items totally unrelated to knots, when my eye was caught by four plates on ropemaking. In Plate 475 the spun fibre is shown being turned into yarn. The next plate shows yarn being converted into two strand twine or 3 strand 'marline'

We then see the manufacture of ropes and cables and in one section of the illustration the twisting of the ropes is done by hand with one man for each rope.

Plate 478 showed an aspect of rope manufacture that I have not seen mentioned elsewhere. This was tarring of ropes or cable. The cable was payed through cauldrons of molten tar then spread in special ovens for a day or two to allow the tar to impregnate the fibres and dry out.

Was this practice universal or a French speciality?

Other uses of ropes and knotting are shown in other sections including those covering weaving, carpet making, tapestry and pile-driving. Diderot was originally published between 1751 and 1780.

THE 1994 AGM

May 7th 1994 is the date for your diaries but there is much more than just the AGM to look forward to. The Nottingham Sea Cadet base at TS ORION is a superb site on the banks of the River Trent and we hope to make a weekend of it. There will be access to the site on the evening of Friday 6th for those who wish to set up early, the AGM will be on the Saturday morning followed by a whole series of workshops, demonstrations, presentations and displays, and for those who have the time, we shall continue over to the Sunday as well. There will be a licenced bar on site for Saturday lunch time and lunch will be available for those who order it in advance. I hope to arrange a dinner at a local Yacht Club (also riverside with good views) for the Saturday evening if enough people are prepared to commit themselves in advance. There is limited bunkhouse accommodation on site and plenty of Bed & Breakfast or Hotel/Guest House accommodation nearby. Nottingham itself is easy to reach by public transport and well served by road from north, south, east or west and its central location in the country should draw in members from all over. Details of all the arrangements will be sent to members by Nigel as usual and this is really just to whet your appetites and urge you to respond promptly when the time comes to facilitate arrangements.

The Commanding Officer of TS ORION has kindly agreed to some of us mooring our narrow boats alongside for the weekend (though if there are vast numbers some may have to use the moorings on the

other side of the river and be ferried across!) and it is also likely that the Sea Cadets themselves will be boating that weekend. It should therefore be possible to run trips on the river and across to the world famous International Watersports Centre at Holmepierrepont where there is always something exciting happening either on the rowing course or the whitewater canoeing course. As far as the knotting programme is concerned we shall have the use of various buildings both large and small so there will be plenty of opportunity for demonstrations and workshops both formal and informal. At the half yearly meeting a Pitsea in October a number of people volunteered (or were nobbled!) so we have the makings of an excellent programme. However there is room and time for more so if you have something you'd like to offer please get in touch with me as soon as possible. My New Year's resolution is going to be NOT to leave everything to the last minute but in this instance I can only do this with your help! I am sometimes a bit elusive on the phone at home but you can usually get hold of me on my office number and there is also a 24 hour answerphone on it. I look forward to hearing from you with ideas and requests, and of course to seeing you all in Nottingham in May.

Penny Bodger
33 Main Street, Osgathorpe,
LOUGHBOROUGH,
Leics. LE12 9TA
Tel: Home - 0530 222633
Work - 0602 516526

THE LOCK TUCK SPLICE

By Jerry CRONAN of U.S.A.

I call this system the LOCK TUCK SPLICE, because as the tucks are put in they lock into the lay of the line. Where more security is required, as on a "Man-Rope", add an additional tuck or two.

The line is not unlaidd to make the splice. The ends are taped until the project is completed, and then the ends are whipped and trimmed.

Do not twist the strands to open the lay of the line for splicing - that will introduce a

twist in the project - use a hollow fid. If a twist does develop, it is a simple matter to back out the tucks, re-arrange the line and then re-tuck.

Practice - Practice. (Man-Rope; start with 20 ft of Nylon) I've done several "Man-Rope" safety lines nine feet long, with sail makers whippings in 45 minutes each.

I have used the lock tuck splice to make ladies belts and mens belts, guitar straps, Jacob's ladders, bow-sprit safety netting, "Man-Ropes" (fully adjustable safety lines used by hunters in a tree stand), shelf

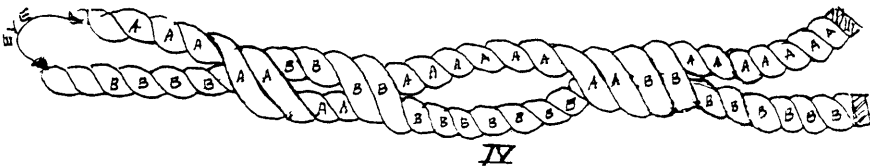
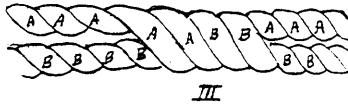
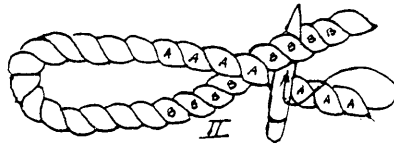
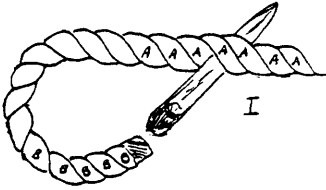

BY
GERALD CRONAN
30 TURKEY ST.
ST LOUIS, MO. 63101
U.S.A.

hangers in a back bar, and to put in a thimble when stropping a block. You will find other uses for the lock tuck splice I'm sure.

The sketches showing how to put in a lock tuck splice are meant to be viewed as if the line is lying flat on a table, and you are looking down on the line.....Good luck.

To practice the Lock Tuck Splice, take a piece of nylon or dacron line about three feet long (1 Meter). (Always use nylon for a "Man-Rope" because the stretch is a benefit).

With the ends taped, form into a bight with the ends even. At the point where a 6 inch (15cm) eye would be formed, put the hollow fid under two strands (AA) as shown in figure 1. Put the end (BB) in the hollow fid, and pull through the slack until the size eye you want is formed. Now remove the fid. You have now formed an eye with the full three strand rope tucked under two strands. All tucks in a lock tuck splice go under two strands.

Now put the hollow fid under two strands in the line you just pulled through (BB) right at the point where it exits part (AA) as in figure 2. Pull the slack through.

Work the parts together and they will appear as in figure 3. That's all there is to it!

Figure 4 is just to show how the lock tucks can be slid apart, and re-grouped again as in the right part of the sketch - locking as a strain is applied. Any number of tucks can be taken , one right behind the other.

Figure 3 (AA)(BB) is the part worn next to the body, the opposite side of the splice is more decorative.

Figure 4 is a sketch of the knot I use to tie belts. I call the knot an INTERLOCKING SHEET BEND. The first time I ever saw it, my son Bob had tied it in a belt I made for him. It may be an original knot, I don't know. I don't do research. Bob said he just kept tying different ways until he got one he liked. I think it is much more decorative than the double sheet bend (becket bend) I always used before.

Anyway - the sketch shows how to tie the interlocking sheet bend (it may hold better than a double sheet bend I don't know) ?

When making a belt, determine the size of the eye by forming a loop and tie the interlocking sheet bend in the loop - then adjust the loop size so the knot doesn't look too crowded etc, Then start making the lock tucks etc. Be sure to leave enough length to the ends so they appear right after tying.

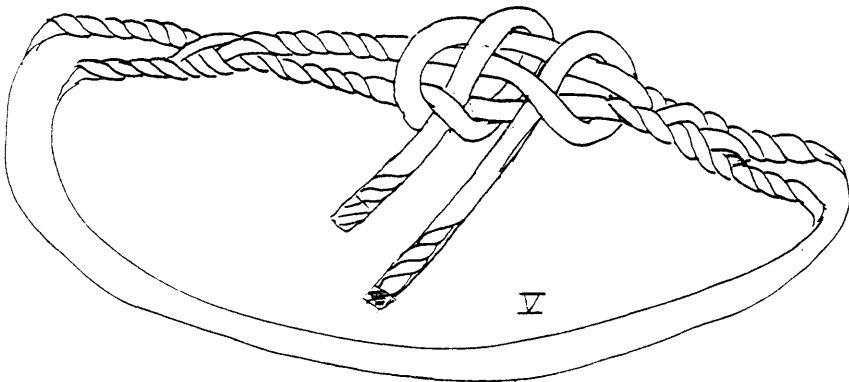

PITSEA - October '93

On Saturday 9th of October, about a hundred members assembled at the National Motorboat Museum, Pitsea, where we were the guests of the Essex branch. Pitsea is not known for its outstanding natural beauty, being in the industrial heartland of SE England, and when members started arriving, they were greeted with absolutely horrendous weather, with wind and torrential rain. However all this was soon forgotten, with the warmth of the reception awaiting us in the museum.

The day started with the usual formal gathering, however the Secretary explained in his long and rambling speech, (does he write speeches for politicians in his spare time?) that every attempt would be made to keep this part of the meeting to a minimum. This could be achieved by sticking to normal meeting protocol such as by not reading the minutes of the AGM, as these should in fact be presented at the next AGM. If he hadn't waffled on so long explaining this, we may have actually saved some time!!

The salient points of his report were that the Constitution had now been revised, and copies were available on request. KM43 and Much Ado About Knotting had just arrived from the printers, and were available for distribution during the day. Also work had now started on the 1994 Membership Directory, as supplies of the now outdated 1992/3 edition were exhausted. The Guild had now purchased a franking machine, which not only creates

for us a more professional image, but saves the Hon Sec hours of licking and sticking. This is our first serious expenditure on proper office equipment, as the membership is rising, bringing with it the need for a more formal approach to the administration. He went on to mention that the existing branches are all still active giving a brief report from some of them, and announcing that several new groups are forming, both in the USA, and in the West Country. Finally, he announced that the AGM would be in Nottingham on May 7th, and the October meeting would be at Fareham, Hants over the week end of the 7th/8th/9th.

With that over, we moved on to a splendid buffet lunch before going back into the Museum, to await the arrival of the High Sheriff of Essex, and his wife. It was here that **Malcolm Bates** and **Don Woods**, together with many members of the Essex Branch, had really excelled themselves, for nestling in amongst the nautical exhibits, was a fascinating variety of different aspects of knotting and ropework, being carried out for the members to watch or participate in.

The Sea Rangers from SRS Solebay, Leigh on Sea, having first piped the High Sheriff on board, spent the afternoon demonstrating "Lanyard Construction". Not too far away **Bernard Cutbush** was displaying examples of his knotwork, and **Howard Denyer** had arranged a continuous show of various knot related videos, including the latest release from

Stuart Grainger.

Frank Harris was actively "putting colour in your turks heads" by showing how to produce some beautifully coloured turks heads, including many of those "impossible ones" - using devious means no doubt, or was it slight of hand? He was in the company of **Harold Scott** who had deviated from his usual speciality of splicing with wire ropes, to demonstrate "Net Construction and Repair". Overseeing these two gentlemen was **Albert RN**, who was also displaying his knot work, which includes knot boards mounted in electric light bulbs!

Ken Yalden arranged "The Six Knot Challenge". Despite tremendous efforts on the part of the contestants, no one came anywhere near the world record of around 8 seconds. It would be interesting to know how that record was achieved in the first place, as there does not appear to be much information available about it.

Jeff Wyatt mounted a display of his decorative knot work, which usually involves items he has found on the seabed. He also had a range of items from the Guilds archives, which proved most interesting, as many members did not know that there is a collection of material.

In view of the weather, **Brian Field** was pleased to abandon Maldon Quayside for the shelter of the museum to demonstrate the art of Mats and Breastplates", and **Neil Henderson** "Constructed a Mouse", The members of the Essex branch displayed items of their own, and had assembled a fascinating display of selected items from the Ashley Collection. **Eric**

Johns presented fenders and other items associated with narrow boats, and **Jan Hoefnagel** actually demonstrated making rope fenders; whilst **Frank Thompson** was talking about his traditional art of sailmaking.

John Smith spoke about new techniques in ring bolt hitching, and **George Aldred** presented solid sinnets and bell ropes. Meanwhile, **Europa Chang**, in traditional dress, was busy making chinese amulet knots.

It was a jolly good meeting, with lots of interesting things to see and do. As is often the case there was simply not enough time available to see everything, and speak to everyone. Perhaps next time? Only having seen the scale of the meeting can one appreciate how much effort has gone into organising such a gathering. Our thanks must go to **all those unnamed members** who worked so hard behind the scenes, both before and on the day, to make the meeting such a success.

HEART KNOT

By Tim RUSSELL of California:

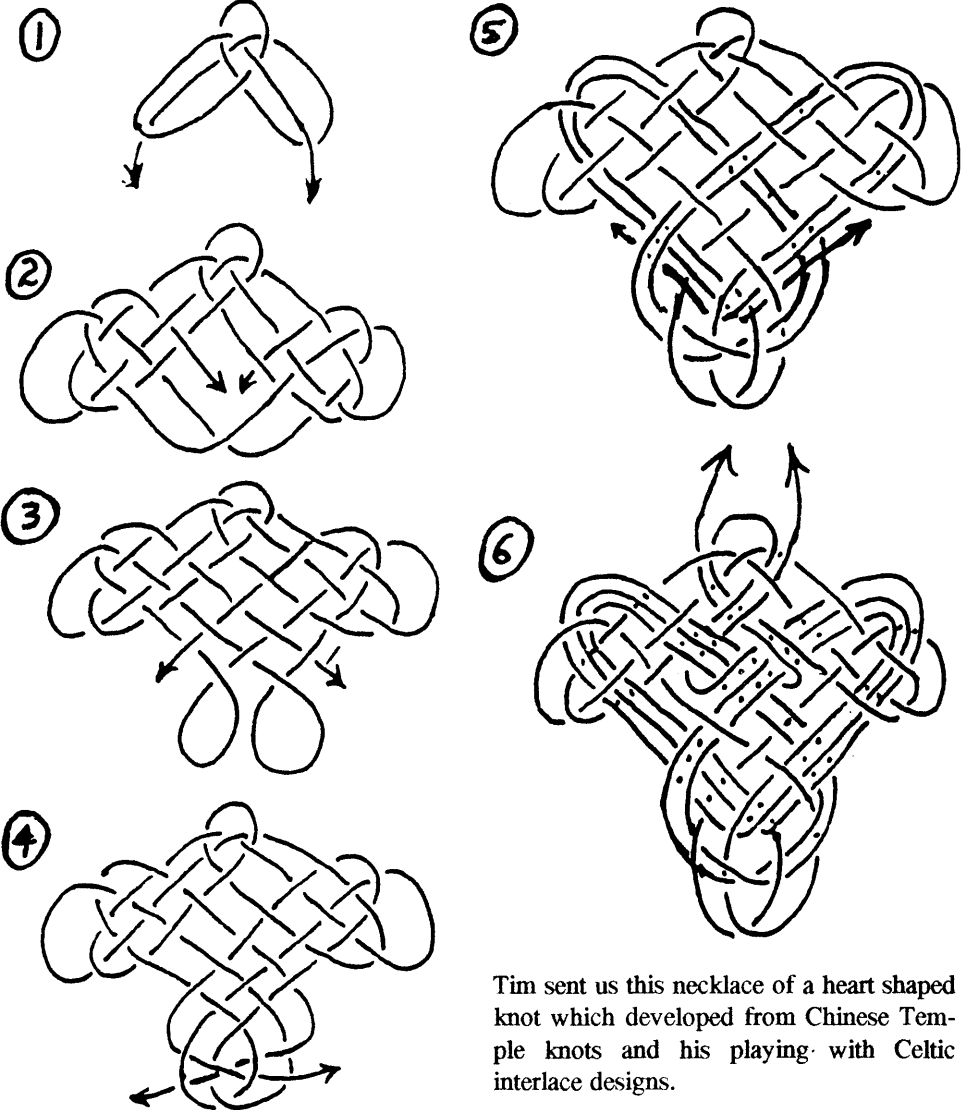

Tim sent us this necklace of a heart shaped knot which developed from Chinese Temple knots and his playing with Celtic interlace designs.

KNOTTING MATTERS

INDEX

to

ISSUES 34 - 43

By

Lesley Wyatt

INDEX TO ISSUES 34 - 43

(41 Early 1993 should have been numbered 42!)

ADVERTISEMENTS

	<u>Vol/Page</u>
Footrope Knots	37/19
I.G.K.T. Supplies	35/20-21, 36/8-9
K.J.K. Ropeworks	34/19, 36/5
Roger Perry - knotting/braiding with leather	38/5
Amending Ashley	37/27
Amending Ashley	38/11
Anecdote - Jan Hoefnagel	38/7
Around the Regions - Essex	39/2
Around the Regions - Knot Year 90 Reports	37/8
Around the Regions - New Zealand Chapter	37/8
Around the Regions - Oxford	37/8
Around the Regions - Surrey	40/23
Around the Regions - SW (Peninsular) Group	38/3
Around the Regions - The Netherlands	38/3
Ashley Project - suggested by Frank Harris	36/14
A Better Mousetrap - Percy W Blandford	37/4

BOOK REVIEWS

The Basic essentials of knots for the outdoors - Cliff Jacobson	37/28
Celtic Design - a beginners manual - Aidan Meehan	36/15
Celtic Design - Knotwork - the secret methods of the scribes - Aidan Meehan	36/15
Chain Grommets - Stuart Grainger	38/24
A Fresh Approach to Knotting & Ropework - Charles Warner	40/31
Knots - Brion Toss	38/28
Knots & Ropework - Nola Trower	41/24
Purjelaivakauden Koysimatot Segelfartygsepokens Repmattor - Arvo Kinnunen	34/6
Ropeman's Handbook	39/32
S4C - Pieter van der Griend	37/28
Braiding Society	40/24
Braid Society -Jenny Parry	43/20
Brandy bottle by Stuart Grainger (photo only)	39/16
Cat o' nine tails (red & gold) - Geoffrey Budworth (picture only)	37/20
ChemText - for drawing knotted structures	34/21
Clyde Puffer - Dan McDonald	35/24
Code of Practice for Members Trading	42/12A
Commemorative Mug - 10th Anniversary	39/19
Cordage Institute	41/28
Definitions - Bolt rope, and Buntlines	38/7

Definitions - Fid	37/23
Dor Makers of Lahore - Cy Canute	34/14
Dowse That Light! - R.L.J.	34/12
<u>EDITORIAL</u>	
general comments	38/2
general comments	40/2
general comments	41/2
general comments	43/2
How to help your editor	37/2-3
Knot Year 90	35/1
New Editor - Lt Comm GJ Perry	36/1
Submitting articles	39/2
Volunteers!	34/1
<u>EDITORIAL</u>	
Articles for KM	35/28
Knot Year 1990	36/24
Late arrival of KM	34/28
Fancy work from the Archives - Decorative handle on walking stick	34/24
"Get K——d!" - Des Pawson	34/20
Girl Guides - knotter badge	38/18-19
Grass Cuttings?	35/21
Heaving Mallets & Heaving Boards - Des Pawson	40/7
Hints & Tips - Chris Eaton	42/5
Hints & Tips - Des Pawson	41/20
Hints & Tips : Fids & Awls - Jan Hoefnagel	43/20
Hints & Tips - Kai Lund	38/23
Hints & Tips - Ken Yalden	40/13
Hints & Tips - Richard Hopkins	41/20
Hints & Tips : Turks Head Former - Peter Pasco	43/20
Hints & Tips - Wend-Wise	42/20
Jan Hoefnagel - photograph	41/14
Index to Issues 30, 31, 32 and 33	34/25
I.G.K.T. - 10th Birthday	37/25
Dr Vaughan Jones elected to the Royal Society	34/12
Knot Year 1990	36/24
Knotboard & frame - a masterpiece by Bernard Cutbush (col photo)	38/16
Knotlore - John Turner	34/4

KNOTS

African Bracelet	41/17
Alpine Butterfly Knot : 4 forms - Henry Asher	37/22
Bend & Loop - Harry Asher	43/10
Bottletop Knot - Jan Hoefnagel	42/5
Bowline : two handed	39/8-9
Bowlines - Owen Nuttall	42/11-13
Butterfly : single strand - Stuart Grainger	38/28
Canal boat fender (picture only)	36/4
Carrick to Constrictor - Geoffrey Budworth	43/6
Celtic Knotting	35/11
Clove to Constrictor - Theo Slijkerman	34/22
Constrictor Knot : a History - Lester Copestake	38/10-11
Corrick "Companion" - Roger Miles	34/17
Covered Jar & Bottle - Stuart Grainger (photo only)	41/10-11
Crinnan Knot : plea for description	37/23
Crown Sennit covering wine jar - Stuart Grainger (photo only)	40/16
Decorative Chain Grommets - Stuart Grainger (photo only)	40/17
Decorative Chain Grommet - Stuart Grainger	37/17
Decorative Chain Grommet III - Stuart Grainger	38/24
Decorative Chain Grommet IV - Stuart Grainger	39/22
Decorative Chain Grommet VI - Stuart Grainger	40/12
Decorative Chain Grommet VIII - Stuart Grainger	41/12
Decorative Chain Grommet XIV - Stuart Grainger	39/31
Decorative Grommet - Stuart Grainger	36/3
Doglead Ring Splice - Gerry Pask	35/21
Dragonfly - William Simpson via Stuart Grainger	41/23
Eskimo Bowline : some explorations - John Smith	38/22
Finnish Mats - Frank Harris (Nov '90)	34/6
Fishing Knots - Owen K Nuttall	43/4
How to beef up a reef knot - Roger Miles	37/6
It all starts with a Simple Half Hitch	41/21
A Jam Knot - Harry Asher	42/26
Knot Chart No 5 - Eric Franklin	38/9
Knotting in Heraldry - Roger Carter	35/2
Lashings : Part 1 - BA Walsh	42/22-23
Lashings : Part 2 - BA Walsh	43/8
Leonardo's Knot	38/6
Leonardo's Knot - responses	39/7
Locked Symmetrical Square - Benjamin Leigh	34/2
Long splice : a new method "Thumb & Finger" - Harry Asher	36/6

KNOTS (cont'd)

Lovers Knot - Geo. Sherwood (1741)	34/5
Macrame half hitch (cording)	41/8
Mathematical Knots - Dr Vaughan Jones F.R.S.	43/12
Monkey's Fist or Keesjes - Bas den Haan	38/25
Novice knots - Bryan Hatto	38/27
Ocean Mat - Ken Higgs	41/13
On a few Longliner Knots	36/21-23
Pearl Knot - "King" de Konig	37/18
Pedigree Cow Hitch	39/30
Perfect Pineapple - Neil Hood	34/3
Picket Line Loop	39/28
Platted Moebius Bands - Geoffrey Budworth	34/7
Poldo Tackle : 'Fidspike'	40/22
Qeqertasussuk Knots - Pieter van der Griend	42/6
Rhombic Bend - Roger Miles	37/7
Sheet Bends : direct v oblique	38/5
Sheila's Star Mat - Des Pawson	42/25
Single Strand Matthew Walker - Neil Hood	42/27
Spherical Covering Knots tied with 2 strands	38/14
Spliced Eye Bowline	36/10-13
Square Knots a new way - Henry Gillespie	34/18
Square Knotting	35/18-19
Square Mesh Netting	34/16
More square mesh nets - Percy Blandford	35/4
Stopper Knot "Twixie" - Cy Canute	37/21
Symmetrical Hawser Bend	43/22
Tarbuck Knot - Cy Canute	41/15
Tudor Rose Knot	43/17-19
Turks Head variants - Kobierczynski Jurgen	37/5
Turk's Head : Two head	40/3
Turk's Head : Two part twined	39/4
Knotting An Academic Subject? - Penny Bodger	41/16
Knotting Classes (in Dutch)	36/14
Left Hand-Right Hand? - Des Pawson	42/14
Les Roses de Saadi	36/18
<u>LETTERS from</u>	
Penny Bodger	42/17
Lonnie Boggs	35/16-17
Geoffrey Budworth	35/17
Geoffrey Budworth	38/4

LETTERS from (cont'd)

Geoffrey Budworth	38/21
Geoffrey Budworth	43/7
Cy Canute	37/18
Roger Carter	39/20
John Constable	38/20
Europa Chang Dawson	38/21
Europa Chang Dawson	42/18-19
Eric Franklin	38/8
Jim Garsides	34/34
Peter Goldstone	35/13
Judyth Gwynne	42/6
B.S. Hatto	37/24
Bryan S Hatto	40/8
Ken Higgs	41/20
Jan Hoefnagel	39/10
Richard Hopkins	40/24
Keith Howard	35/3
P.W. Hughes	42/18
Robert Jackson	41/3
Sten Johansson	39/6
Sten Johansson	41/18
Dr Vaughan Jones	43/11
Alan King	35/13
'King' de Konig	37/18
LuAnne Kozma	42/17
Alan McDowall	43/7
Desmond Mandeville	35/4
Cary Parks	35/23
George Pask	38/4
Des Pawson	40/8 & 9
Bob Schwartz	36/19
Craig Sigurdson	38/20
Edgar Sinder	42/6
John Smith	34/22
Mike Storch	36/24
Mike Storch	39/21
Ettrick Thomson	35/15
John Turner	38/8
Charles Warner	35/14
Don Woods	41/3

Macrame Hammock Seat - Stuart Grainger	34/12
Magnus the Viking	42/4
Merchant's House Museum, Plymouth - Display - Ray Tucknott	35/12
Mind Bending	34/2
Naval Watchkeeping Telescope	41/15
New Members	40/9
New Members	41/2
New Members	42/2
<u>OBITUARY</u>	
Ron Christian	34/21
Tom Hodgson	34/15
Neil Hood	40/11
Desmond Mandeville	40/10
Peter James Webb	43/2
On Nets of "Knox" - Bryce K Knox	40/4-6
Open Sesame - Bend & Loop - Harry Asher	43/10
Patented Knot Tyer (JR Henderson) - Edgar Sinder	34/23
Personality Piece - Tim Field	38/12
Personality Piece - Nigel Harding	39/2
Personality Piece - Vaughan Jones	40/28
Point to Point Tramble - Desmond Mandeville	34/10
Presidential Speech - Stuart Grainger (a precis)	36/2
Prince Lee Boo - Geoffrey Budworth	37/16
Problems in Paradise - Pieter van der Griend	37/11-16
Proof of the law of the Common Divisor in Braids - JC Turner & AG Schaake, Univ of Waikato, Hamilton, N.Z.	35/6
Puzzle Page - Rubik's Tangle	37/21
Puzzle : What Knot?	42/5
<u>QUOTATIONS</u>	
Douglas - pre 1832	40/9
Douglas' Military Bridges	38/19
Sir Arthur Conan Doyle,1917	36/5
A.S. Gillette & J Michael Gillette - 1981	42/17
Graffiti by Peter van Greenaway	39/32
Instruction in Military Engineering Vol I	39/14
Dan McDonald, 1977	35/24
Terry Pratchett, 1990	38/11
Rope Bridges	38/19
Russell Thorndike, 1935	35/17
Russell Thorndike, 1936	34/5
Brion Toss - Master Rigger, 1984	37/4

A Rope in Case	36/17
Rope twirling - Geoffrey Budworth	36/16
Ropelore Snippet - 'Britannia' mooring lines	34/14
Ropelore Snippets - 1. Eugenius Birch 2. Joseph Huddart	36/4
Ropework signatures - Cy Canute	42/17
Smart Rope" - John Woosey	40/13
Supplies List - I.G.K.T.	35/20
Supplies List - I.G.K.T.	36/9
Supplies Secretary - Mary Harrison	34/9
Survival of the Simplest - a some more heresy	39/22-27
Tardy Tar	36/18
Teaching Knots - Carey Parks	35/22
Technology of Fibres - Bryan S Hatto	40/18-22
Technology of Fibres (more)- Bryan S Hatto	41/8-10
Ten Years On	42/16
Ten Years on - Never Lost a Bottle	41/24
Testing Knots - Charles Warner	42/22
Texel Anchor - Jan Hoefnagel (photo only)	39/17
Toggle Rope - Brian Lamb	39/5
Tom Bowling - Ode	41/7
Tom Bowling & the Gunner's Knot - Lester Copestake	40/25-27
Tool Tip - Geoffrey Budworth	40/30
Tool Tip - Loop Buttoner - Theo Slijkerman	43/21
Tool Tips	38/26
Tool Tips - Geoffrey Budworth	39/29
Try Your Hand - Ken Higgs	35/24
T-Shirt motif	39/19
U.S.A. Meeting	43/20
Victorian Kitchen Garden	42/5
VIDEO REVIEW Knotcraft - Stuart Grainger	42/5
You, your tools and the law - Geoffrey Budworth	39/11-14

JEKYLL & HYDE KNOTS

by Geoffrey BUDWORTH

Some knots exist in two forms, one stable - the other very unstable. The late Desmond Mandeville - reminded of the schizophrenic doctor in Robert Louis Stevenson's 19th. century story of the supernatural - named them Jekyll & Hyde knots.

Ashley's Whatnot (#2579) (fig.a) is an example. It is perhaps the least secure of bends. He awarded it his skull-and-crossbones symbol for untrustworthiness. Rearrange both working ends within the knot, however, and you have the Jinx (fig. b). This is as strong as needs be under a steady load. It is possible, by switching deliberately from slippery to locked version, to contrive a quick lightweight lashing, e.g. on garden trellis-work.

This sort of internal shunt or shuffle (usually with working ends), without untucking and re-tucking, is the hallmark of all Jekyll & Hyde knots.

Another such knot is the Thief (fig. c).

The locked Tumbling Thief (fig. d) is, curiously, the slimmest bend; i.e. it passes through a smaller diameter hole than other bends.

The Blind Bend (#1408, 1409) (figs e & f) is yet another Jekyll & Hyde knot.

Even the Reef and Granny can be

Unstable

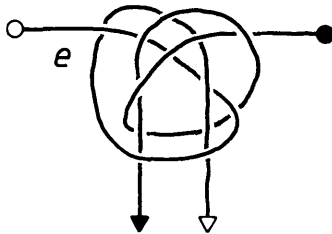

Stable

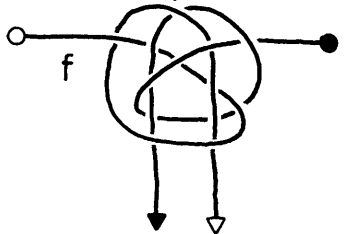
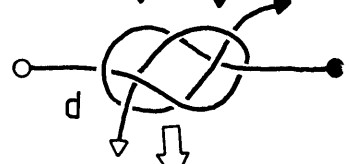
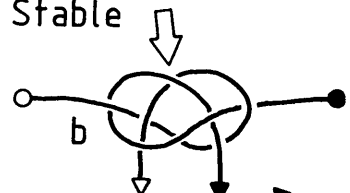

secured by shunting, although the results are impractical (and so are not shown here).

Are there any others we should know about?

MUCH ADO ABOUT KNOTTING

Corrections

By Geoffrey BUDWORTH

It was inevitable that the booklet Much Ado About Knotting, a History of the International Guild of Knot Tyers (the first decade, 1982-1992), would be slightly flawed. All publications are these days. Too many people handle them, too fast, for it to be otherwise.

The errors are comparatively few, and you may dump blame equally upon me (the writer), the printer and a Guild officer or two in between. As there is no plan to re-print this commemorative booklet, members might find a list of our typo's and bloopers helpful.

* Inside front cover - title page:
amend 'George Budworth' to read Geoffrey Budworth'

* ACKNOWLEDGMENTS - para 2:
amend line 2 to read '...Guild members who helped resuscitate knotting when it seemed....'

* INDEX - Miscellaneous:
amend 'Publications.....24'
to read 'Books & Booklets.....24'

* Delete I.G.K.T. Officers, etc: insert OVERSEAS CO-ORDINATOR and COUNCIL MEMBERS..(See also IGKT OFFICERS).....25

Add (under Shop Window)..I.G.K.T OFFICERS....'Inside rear cover';

Section Five - NEW IDEAS (N-to-Z):

Insert in alphabetical order

O ... Ornamental wire ropework

Ex-trawlerman Harold Scott created

Escher-like knot puzzles. Handsome to see, they were - amazingly - made in wire rope. P... Pile (or Icicle) & Pedigree Cow Hitches:

item (ii), line 2; amend adaopted to read ... adopted'.

* Section Six - BRANCHING OUT:

para 2, line 2; amend 'Glad Findlay' to read 'Glad Findley'

* Section Seven - OVERSEAS:

para 5, line 2; amend 'Glad Findlay' to read Glad Findley' and 'Frank harris' to read 'Frank Harris'

* Section Nine - SO FAR, SO GOOD:

Para. 1, line 1; amend 'Guild members' to read 'Guild membership'

* Section Ten - WHAT NEXT?:

Para 3, line 1; amend ' language' to read 'languages'

Para 6, line 3 amend 'mights' to read 'might'

* BOOKS & BOOKLETS - under Books:
amend 'Grainger, Stuary.....(Wiltshire, 1991)

to read 'Grainger, Stuart.....(Wiltshire, 1991)

amend 'Merry, Barbar' to read 'Merry, Barbara'

amend 'Warner, Warner' to read 'Warner, Charles'

under Booklets:

amend 'Blandford, Percy ' to read 'Blandford Percy'.

under Booklets:

amend 'Blanford, Percy ' to read 'Blandford Percy'.

amend 'Budworth Geoffrey....Plaited Moebius Bends'

to read 'Budworth Geoffrey....Plaited Corrections Moebius Bends'

The photograph on page 4, of the 25 founder members aboard Discovery for their inaugural meeting, actually has 26 heads. The shipkeeper crept in somewhere. The text lapses oddly into italics here and there. I can explain this. After submitting my typescript to Council, I made several amendments - which I underlined to save our Secretary having to compare each corrected page line by line, word by word, with the original one. I should have known better. Printers use underlining as an instruction to print in italics, which - of course - is just what they did.

OPEN SESEME

Correction

Harry ASHER also offers a thousand apologies for the errors (some of you spotted) in KM 43.

Pages 11 and 12 please change your copies as follows:

Figs 1a,b and c to read 2a,b and c.

Figs 2a,b and c to read 1a,b and c.

1d is correct as labeled.

By Ed... As a suggestion - for those of you with access to a photocopier - copy the offending diagrams and re-locate as appropriate.

AROUND THE REGIONS

WEST COUNTRY BRANCH FORMED

At a meeting held on Saturday 25th September 1993 it was agreed to form a West Country Branch of the Guild to cover the area of the present counties of Avon, Gloucestershire, Somerset and Wiltshire.

There are at present twenty members of the Guild in these four counties, and as a result of writing to each one of them, eleven expressed interest in the formation of a Branch. Not all eleven were able to come to the inaugural meeting so, although we currently have only six 'paid-up members' of the Branch, it is expected that this number will have doubled by the time this issue of 'Knotting Matters' is read.

It has been decided that the Branch will be known as 'WEST COUNTRY KNOTTERS' - less of a mouthfull than the 'The West Country Branch of the International Guild of Knot Tyers' - and much easier to write on cheques!!

A steering committee of Roger STARR (Chairman) and Les BAKER (Secretary/Treasurer) is holding the fort until the next meeting in January 1994 when a full committee will be elected.

Contact: Les BAKER
30A Moorcroft Drive,
Longwell Green,
BRISTOL,
BS15 7DP.

East-West OCEAN PLAT MAT

Don REMPE of USA writes.....

While looking through some back issues of KM, I saw in issue 41, Ken HIGGS discussion of an easier way to tie the "Ocean Plat Mat".

Most illustrations of how to tie this mat have the long dimension in the North-South direction. I find it easier to tie in an

East-West orientation. Using 1/2" diameter rope, it takes 100 feet to make a nice looking 18"x30" six strand mat.

Figure 1 sets the initial pattern and as in Ken's method, all passes are "over".

Figure 2 completes the mat.

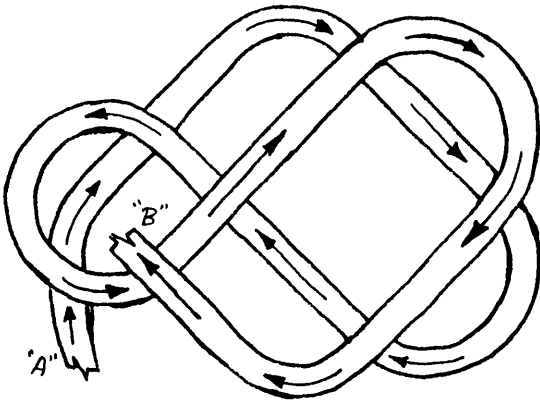

FIGURE 1

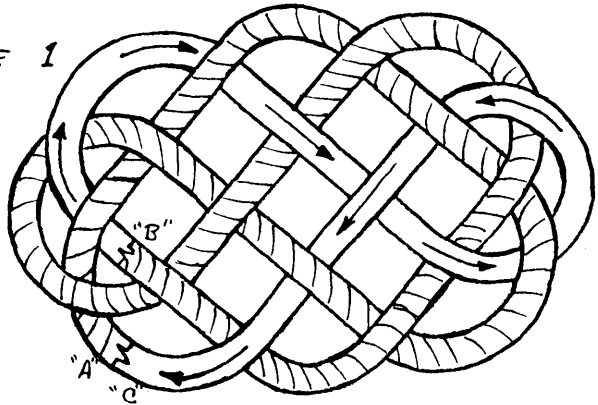

FIGURE 2

KNOTTERS WORKBENCH

David ROGERS from Wales writes...

When I am at Guild meetings, I often wonder where the knot tyers I see around me work on their craft. On the kitchen table? In the spare room? Perhaps one or two have a dedicated workshop with a rigger's bench and coils and hanks of cordage all round them!

I used to work at a desk in a room known as 'The Study' (Really a sort of second-hand book store and walk in waste paper dump). The problem was that unfinished work had to be moved away to allow for letter writing and so on. When the project was picked up again, the ends of line always seemed to have 'Ashley-fied' themselves into a

whole series of Carrick bends and stopper knots. The answer seemed to be some form of bench where the work could be left and taken up again later without the need to stow it away in a box or on a shelf.

There should also be facility for keeping tools close at hand. I decided the specification should be:

1. A portable bench running on castors with a height of about two feet.
2. Space under the bench for materials.
3. Recessed compartments to hold small items like boxes of needles, palms etc.
4. Slots for things like fids, Des PAWSON's loop tools and so on.
5. The bench to be capable of going under a small table for neatness and protection from dust (and grandchildren!).

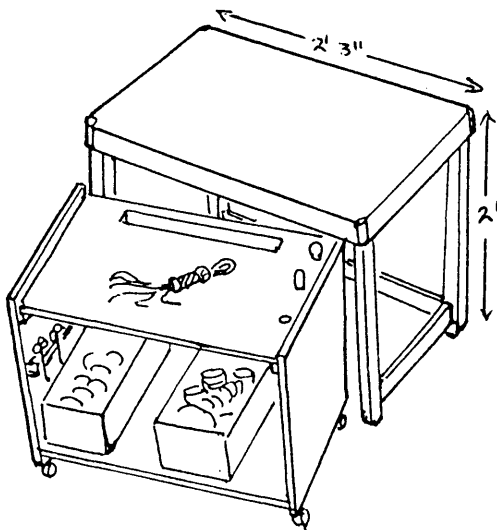

The sketch shows what eventually resulted.

It's made of pine and varnished. The table and bench

were designed and build to work as one unit.

It would be interesting to hear from other Guild members about their working conditions.

KNOTTING BRICKLAYER

By Cy Canute

When I was a young Sea Scout we all shook hands LEFT handed. It set us apart, a kind of secret sign. Didn't we also fasten our shoes in a special way? The laces weren't tied with visible bows. Somehow the tag ends were buried but just how we did it I can't recall.

It was seeing a bellrope in our Scout hut that triggered off my knotting and started me on all the traditional sailors' knots depicted in those dated manuals (I mean, whoever actually used a Nelsonian "comb-hanger"?). Very early on, however, I was seduced by macrame'. I can-and-do work on it for hours at a stretch. Yet hardbitten characters sometimes try to make me ashamed of my indulgence. Just as the efforts of impressionist painters are belittled because they have abandoned formal draughtmanship, so I'm often told my masterpieces are "...not real knotting".

What nonsense! Of course it's real knotting. Macrame' is reef knots and clove hitches (or paired half hitches, if you like), hundreds of thousands of the little beauties, cunningly repeated to produce striking effects. I reckon I've tied more reef knots and clove hitches than an entire fleet of sailormen could have done in a lifetime of voyaging. Macrame' is like laying bricks. A brick is crude and simple but put enough of them together with skill and you can build a cathedral. Macrame' makes proper knotting as bricklaying

creates architecture.

Mind you, macrame' is an ugly word. Nobody's certain how to pronounce it, and any meaning it once had has ceased to be relevant. The Americans have the right idea. They call it "square-knotting". Their term 'square knot' refers, of course, to the reef knot; so, why don't we British just call it "reef-knotting"?

I once worked with a cultured literary chap who, seeing my knotting, asked; "What's it all called? Is there an '-ology' for this sort of thing?" "Well, it's - sort of - just known as fancy or decorative ropework," I mumbled inadequately. "Rot," he announced brightly. "There's bound to be and '-ology' for it. I'll just go away and unearth it for you." That was about 1963. He's never come back. I wonder what he found. Does anyone have any idea?

oooOOOooo

QUOTATION

"KNOT TYING. The fastest recorded time for tying the six Boy Scout Handbook knots (square knot, sheet bend, sheep shank, clove hitch, round turn and two half hitches and bowline) on individual ropes is 8.1 seconds, by Clinton R. Bailey Snr., 52, of Pacific City, Oregon, on April 13, 1977."

GUINNESS BOOK OF WORLD RECORDS', revised edition (1980)

DAHLIA KNOT

NOTES ON THE DHALIA KNOT

By Stuart GRAINGER

1. **Bernard CUTBUSH** showed me and others this knot at the Annual General Meeting of the International Guild of Knot Tyers on 8th May 1993 at T.S. "VERNON" in Birmingham and asked me to draw it for publication.

2. The Doubled Crown (figs. 1,2 & 3) can be tied clockwise or anti-clockwise, according to preference, but the remainder of the Crowns should be tied in the sequence shown.

3. The steps shown in figs. 10 and 11 form a secondary row of small 'petals' which can be pulled up tight as in fig 12, or opened out like those in the first row (fig. 9).

4. The knot has been drawn as tied in six strands, but eight strands are equally effective, if not more so. In fact there is no finite limit to the number of strands, but larger numbers require a core.

5. This knot is particularly useful as a base, because it has a cavity at the centre, into which, for instance, a candle may be placed and the knot used as a candle stick, or a lampholder could be fitted in a similar way.

6. I have found that two quite decorative variations of this knot can be made. The first, by preceding the drawn sequence with a Crown of pairs, that is a Crown tied using the six strands as three double strands, or with eight strands used as four

double strands. This provides a bud-likecore at the centre, but removes the facilityof the central cavity mentioned at 5. above.

7. A second variation is provided in finishing the knot, after fig.11, by tucking the strands upward through the centre of the knot, then combining and/or steaming them and trimming with a pair of scissors, so as to produce a rather different kind of flower form, somewhat resembling a thistle.. Again this variation forfeits the useful centre cavity, but it can be used to introduce material of a different colour and/or texture at the heart of the 'flower'.

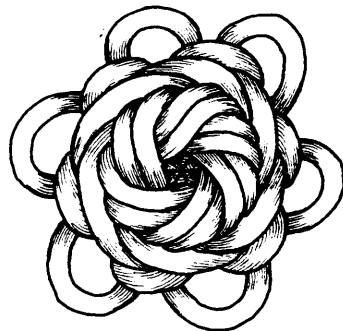

§ 9-93

The Dahlia Knot

Developed by Bernard Cutbush
Drawings by Stuart Grainger.

Seize together six equal strands.
Tie them into a Crown Knot
anti-clockwise,

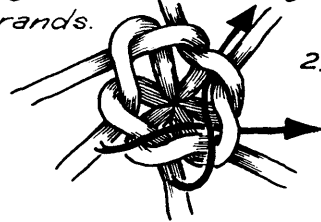
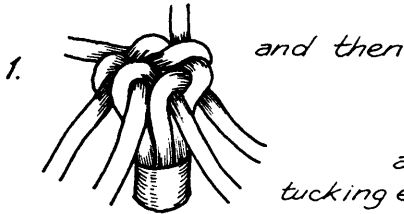

double the Crown,
as shown in Fig.2 above,
tucking each strand a second time.

3. The Doubled Crown.

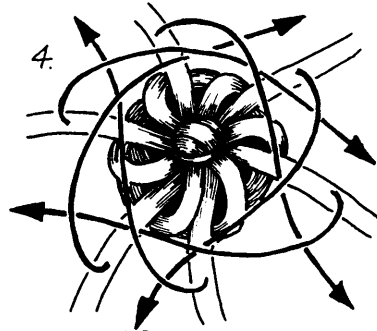
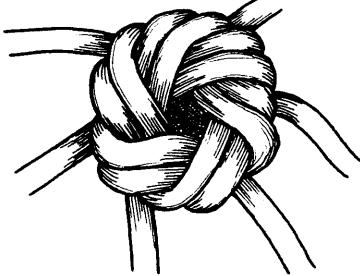

Turn the Knot over and tie a second Crown clockwise
and over two strands (see Fig.4 above).

5. Crowned over (& under)
two strands.

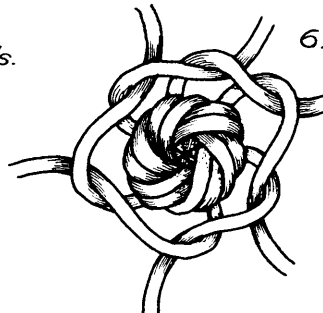
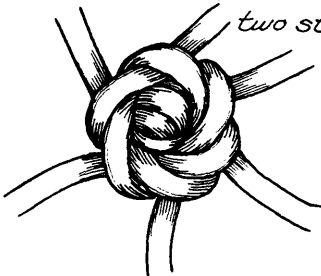

Turn the Knot over again and tie a Crown clockwise.

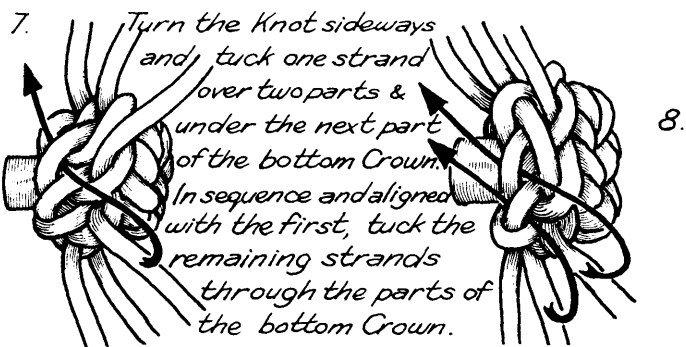

Open out the loops thus made to form "petals".

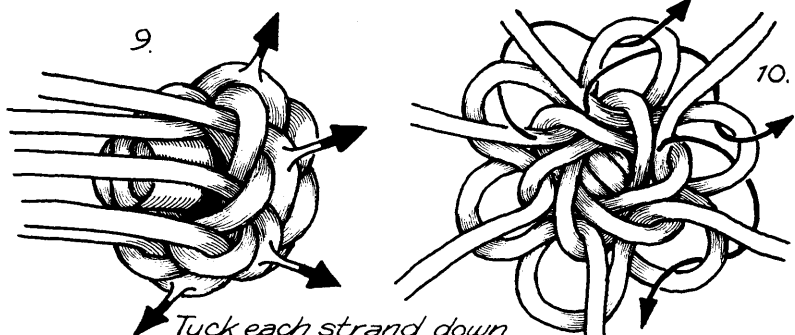

Tuck each strand down through its nearest petal, up through the next to the right, then tuck all to the centre under the bottom Crown.

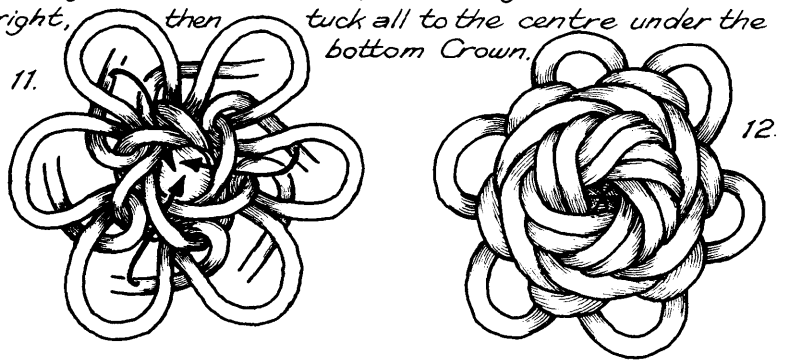

Bernard's Dahlia Knot.

§ 9-93

SPANISH HITCHING

It's quick & easy with **Jack FIDSPIKE**

Spanish hitching is Charles L. Spencer's name for it. Others, writing about pointing (and such), call it grafting. Anyway, it builds up a pleasing cover on a bell-rope, handle, or what-have-you.

Don't be put off because you don't have enough fingers to hold all those loose working strands firm. There's a trick to it. Simply tie the filler strand to a table leg, door knob or other anchorage, at least a metre away from you. Keep it taut with the hand holding the work. Use your free hand to flick, tuck and pull each strand in turn snug and tight.

Rotate the work, pinning the newly tucked strand in place, and bringing the next one around ready to tie off. Periodically - before it reels you in - loosen and lengthen the filler strand on its mooring.

Overhand hitches (as shown) look even better with one or more coloured strands included. They spiral around the finished article. Reverse half-hitching is an alternative. So is double half-hitching (clove hitches). All can be made by this method.

(right-handers, you may prefer to work the opposite way to that shown.)

Discover more detail in:

Ashley (*The Ashley Book of Knots*), page 563, paras. 3353-6;

Grainger (*Creative Ropecraft*), pages 96-7;

Smith (*The Marlinspike Sailor*), pages 83-5;

Smith (*The Arts of the Sailor*), pages 116, 199-20;

Spencer (*Knots, Splices & Fancy Work*), pages 109-110;

Warner (*A Fresh Approach to Knotting and Ropework*), page 198

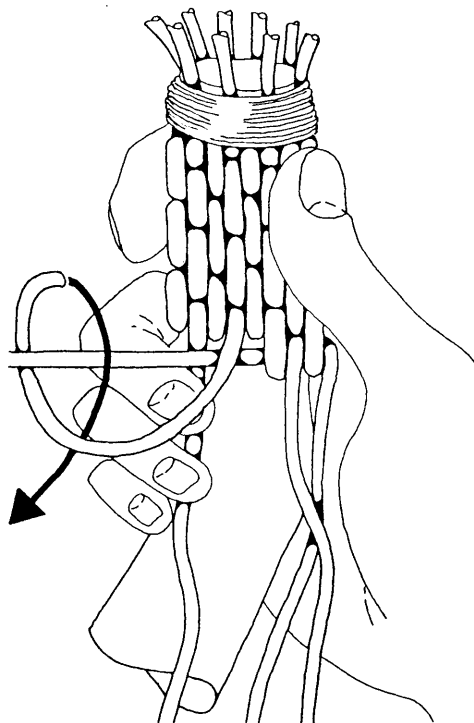

GUILD SUPPLIES

I.G.K.T. BOOK PRICE LIST 1993

ITEM	WEIGHT	PRICE
THE KNOT BOOK Geoffrey BUDWORTH	95 gms	£2.50
LASHINGS Percy BLANDFORD	55 gms	£2.50
BREASTPLATE DESIGNS Brian FIELD	65 gms	£2.50
TURKSHEADS THE TRADITIONAL WAY Eric FRANKLIN	110 gms	£1.50
KNOTCRAFT Stuart GRAINGER	130 gms	£3.25*
ROPEFOLK Stuart GRAINGER	30 gms	£1.30*
TURKSHEAD ALTERNATIVES Stuart GRAINGER	30 gms	£1.20*
AN INTRODUCTION TO KNOT TYING SOME SPLICES AND LANYARD KNOTS Stuart GRAINGER		Available as a set while stocks last at a special price of £2.00

Weights are stated as a guide in calculating POSTAGE.

* Indicates 33.3% discount available on orders worth £30 or more at retail prices.
Subject to availability of stock.

SUPPLIES SECRETARY

3 Walnut Tree Meadow
Stonham Aspal
STOWMARKET
Suffolk IP14 6DF
Tel: 0449 - 711121

