

ISSUE 69 DECEMBER 2000  
ISSN 0959-2881

# Knotting Matters

Newsletter of the



# Guild Supplies

## Price List 2000

Item	Price
<b>Knot Charts</b>	
Full Set of 100 charts	£10.00
Individual Charts	£0.20
<b>Rubber Stamp</b>	
IGKT - Member, with logo (excludes stamp pad)	£4.00
<b>Guild Tye</b>	
Long, dark blue polyester, with knot motif	£8.95
Long, dark blue tie with Guild Logo in gold	£8.95
<b>Badges - all with Gold Logo</b>	
Blazer Badge	£1.00
Enamel brooch	£2.00
Windscreen Sticker	£1.00
<b>Certificate of Membership</b>	£2.50
parchment scroll signed by President and Hon sec for mounting and hanging	

Cheques payable to IGKT, or simply send your credit card details  
**PS** Dont forget to allow for Postage

**Supplies Secretary:- Bruce Turley**  
**19 Windmill Avenue, Rubery, Birmingham B45 9SP**  
**email 106077.1156@compuserv.com**  
**Telephone: 0121 453 4124**

# Knotting Matters

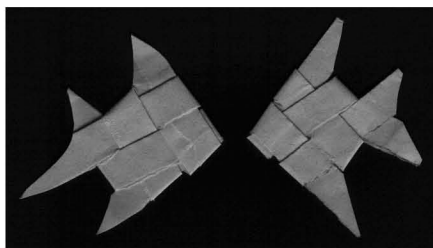

*The Fish Knot*

**Newsletter of the  
International Guild of  
Knot Tyers**

**Issue No. 69**

**President: Brian Field  
Secretary: Nigel Harding  
Editor: Colin Grundy  
Website: [www.igkt.craft.org](http://www.igkt.craft.org)**

Submission dates for articles

KM 70            07 JAN 2001

KM 70            07 APR 2001

The IGKT is a UK Registered  
Charity No. 802153

Except as otherwise indicated, copyright  
in Knotting Matters is reserved to the  
International Guild of Knot Tyers IGKT  
2000. Copyright of members articles  
published in Knotting Matters is reserved  
to the authors and permission to reprint  
should be sought from the author and  
editor. All sources of quotations printed  
in Knotting Matters are acknowledged.

Cover design by Stuart Grainger

## IN THIS ISSUE

<b>How I make my Knot Boards</b>	<b>5</b>
<b>Knotty Limericks</b>	<b>7</b>
<b>Millenium Knots</b>	<b>8</b>
<b>The Knot Tyer's</b>	
<b>Jargon Generator</b>	<b>12</b>
<b>Book Reviews</b>	<b>13</b>
<b>Knotmaster Series</b>	<b>14</b>
<b>A Comment on Knot Slops</b>	<b>16</b>
<b>Maya Ropemaking</b>	<b>21</b>
<b>Knot Gallery</b>	<b>22</b>
<b>A Sea Chest</b>	<b>28</b>
<b>Fish Knot</b>	<b>31</b>
<b>The Turk's Head Conundrum</b>	<b>34</b>
<b>Drawing Knots</b>	<b>40</b>
<b>Allaboutknos.com</b>	<b>41</b>

# Notes from the Secretary's Blotter

**I**t doesn't seem like just three months since I last sat down to write these notes, but it is, and that means yet another year has slipped by. A lot of water has flown under the bridge, and in the case of Uckfield, over the bridge, and up the High Street as well. Although I was fortunate enough not to have been affected by the flooding, I would like to thank all those who telephoned to see if I was alright. Ever optimistic, I thought that it was a last rush of budding secretaries wanting to get their applications in - but no such luck.

I can report that I have just returned from a most enjoyable weekend in Beverwijk, courtesy of Willeke and the Dutch Members. This meeting will be reported upon in the next KM, as this one goes to press in this weekend. As one of the items on the agenda was to approve the accounts, which were delayed because the authorities were slow in issuing us with the bill for the October 99 meeting, this did remind me that the Guildford meeting had gone unreported due to a quirk of fate.

The meeting was probably our best so far and certainly was the best attended, with about a hundred and thirty members and guests attending. There was an ambitious programme of talks and discussions, making full use of the modern lecture theatres and extensive range of

visual display equipment. If members traverse the globe to get to a Guild meeting, then I believe that the quality of that meeting should justify the effort they have made in getting there. If any criticism were to be made at all about this particular meeting, then it would be that there was so much going on that 'difficult choices' had to be made. Overall it was a very professionally produced event, which had taken the organisers a lot of time and effort to put together, for which I have thanked them on your behalf.

This had been an experiment, which I believe, was successful, but did highlight a number of aspects that the Council needs to consider when planning future meetings.

Probably the most difficult issue was the high level of security on site, which did create a number of difficulties, both before and during the meeting. This did deter the casual visitor, and those whose life style is not quite so well ordered as others. This was not the first time that security had been a problem, as many members found to their cost at Portsmouth Dockyard. The Council is aware that many members found this a prohibitively expensive meeting, and in order to redress the balance, will ensure that this will be borne in mind when fixing other venues and events.

This moves me on to my next thought, which is that of keeping the Council in touch with the membership. Is the Council doing well, or should we all be sacked? Hopefully the answer is nearer the former than the latter, however there has been a recommendation that Members should have a greater say in what goes on. Personally, (that is me speaking, not the Council) I think that if anyone were to want a greater say then they would put their name forward for election to the Council - perhaps even as Secretary. It is not practical to increase the number of Councillors - even with just ten voices around a table makes for slow progress. In any case, we have had difficulty in finding volunteers to fill the present posts and help with subcommittees. Although the law does not forbid it, Council members from outside the UK would present practical difficulties, especially with travelling and accommodation costs, which would have to be paid for out of our limited funds. We hear of the technical break-through enabling video/telephone conferencing, but even the major global companies prefer to sit around a table. Hence another non-starter.

It has been suggested that as no one knows what the Council are doing, how can members form an opinion of whether they on track or not. The Council has no secrets, and the minutes of their meetings are always available at the General Meetings. They are fairly boring. No - extremely boring, I should know, I write them. If any member would like a copy of the Minutes of Council meetings, then I can provide them for the cost of postage and packing. If anyone has an issue they

wish the Council to discuss, then you can simply write, or talk to the secretary, whose job it is to bring these things to the attention of the Council. Similarly, if I am unavailable, or you have problem with me, then there are nine other Councillors who can be approached (unfortunately none of them are anxiously waiting for my job).

Recently it was pointed out to me by a potential member from the Asian Continent, that our membership fee is the equivalent of two days pay for him. One of our members has since observed that this is much the same as UK members who are living on the basic State Pension.

Quite a significant period of time passes between me putting pen to paper and my words and thoughts appearing in print on your doorstep. Although we have not yet 'put the clocks back' to our beloved GMT, I must take this opportunity to hope that you have all had a good start to the New Millennium (that reminds me - have you sent your postcard and knot to Ken Yalden), and to wish you all a joyous Christmas, and a Happy New Year.

*Nigel Harding*

## ROPE ENDS

### Creative cordage

'He met a man . . . who had created a new art form by using knotted string . . . I am, myself, working on a paean composed of fifteen miles of coloured rope which will take an area of two thousand square feet to display to its best advantage.

*(E.C. Tubb, Stellar Assignment, 1979)*

# From the Editor

**W**hen you read this editorial I suppose most of you will be well into preparations for the festive season. At the time of writing however, I have just returned from a weekend of knotting at the Guild half-yearly meeting in the Netherlands. With members from as far afield as Alaska and Germany, this was a wonderful opportunity to meet, talk and learn about knotting.

Well, twelve months have passed in the editor's chair. How quickly the time seems to go. I have now settled into a routine that seems to work; though the thanks must go to all the members who have contributed to *Knotting Matters*.

Keep your contributions coming in, for without them there would be no magazine to read.

One of the recurring themes over the past year has been the Surrey Six. I am still receiving items on this subject. Rather than publish the odd letter here and there, I shall be holding them over to use as an article in a future edition. So please don't think the subject is dead. Far from it send your thoughts either to me or to Howard Denyer and perhaps we can reach some consensus on this issue.

On that note I shall conclude and wish you all a Happy Christmas and productive knotting New Year.



*A Chinese knotting workshop at the Autumn meeting*

# The way I make my Knot Boards

By Des Pawson

**K**not boards are not my first love. There is a certain satisfaction on completing a well-balanced layout with examples of ones skills and knowledge, perhaps with a theme or some special appropriate knots for the person who you are making the board for. I have never wanted to mass-produce knot boards, preferring to aim at the special 'work of art' end of the market.

Frames are always a difficult and expensive thing. I have the big ones made specially by a joiner, who makes a deep moulding and filet strip for me. Then I stain and polish them myself. They are a major expense. A picture framer can make up small frames; perhaps you will be lucky to find a sympathetic one who can trace a good deep moulding. Get your frame first; or else you may find that there is nothing deep enough to take that extra special thing you put on.

I usually use either flax or cotton for the knots, using 3mm i.e. 72-thread cotton for the main knots with either that or possibly 48 th. (a little smaller) for the mats, 12 th. for a hitched bottle (if there is one), and 24 thread for decorative half hitches on a rod. The Turk's heads round that rod could well be then in either 36 th. or 48 thread. Any splices are done in 6 or 7mm cotton rope. Ends must be whipped.

I use the finest waxed whipping twine. Occasionally I will whip the ends with coloured twine, perhaps to match the felt background.

If I use flax, I use the 3mm again either 2406 or the extra quality 6/2 and again smaller sizes for mats and Turk's heads etc. and 6mm or 8mm hemp for the splices. Again all ends must be whipped. I have some heavy sailmaker's machine thread that matches the flax in colour.

Brass tags are very expensive; we do not sell them. It can be cheaper to buy them in bulk, but then you are restrained to the same knots every time. I am lucky in that Liz has a good hand and writes the labels, usually in white ink on a coloured paper that matches the felt background. I stick these labels in place with polystyrene cement, but beware they do not all have the same formulation, test first. If I have trouble I will probably use UHU, which is what Liz uses to glue the sennit on her knotted frames. The backboard is usually 9mm plywood covered with felt.

I fix the knots with brass pins bought from the model shop. Pins through felt enable you to move and reposition, without a hole showing. I hold the pins with a pair of needle nosed pliers, and have a beautifully balanced pin hammer to put them in with.

I always feel that it is the layout that matters. I like to show the knots at work when ever possible, i.e. bends all joining together, hitches to a rod. I only use 'bits of brass' etc. to show the working of a knot, i.e. a block on a thump mat,

miniature bosun's call on a miniature lanyard.

Good luck.

*Below: A fine example of a knot board by Des, with frame decoration by his wife Liz.*

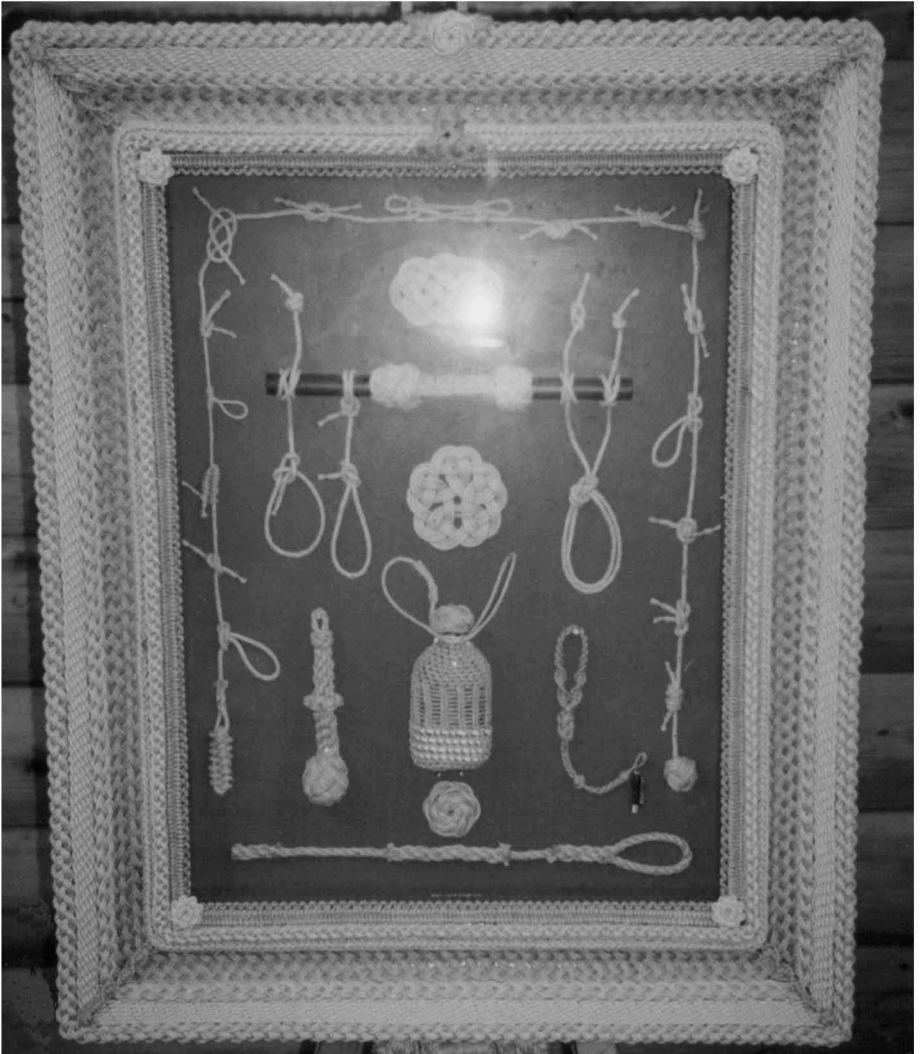



# Knotty Limericks

In the last issue of Knotting Matters, there appeared a request for limericks with a knot tying flavour. For those who have not already guessed, the article came from the pen of former president and knot tyer Geoffrey Budworth. What a little monster Geoffrey has created. Below are a selection from Guild members who have taken up the challenge. I'm sure we have many more poets out there that can create a few lines of limerick. More in the next issue.

## **From Gary Sessions,**

Then there's a guy named Des Pawson  
His knots are inspiring and awesome.  
    His wife's name is Liz  
    Another knot whiz  
And together they make quite a twosome.

I've a good friend named Sam,  
At knots he's much better than I am.  
    When he tyers a bell rope  
    You'll have a big truck I hope  
'Cause the thing will reach to Siam!

## **From Sam Lanham,**

A prim little tyer named Grace  
Took note of a thug near her place.  
    With a large Matthew Walker  
    She clobbered the stalker  
And sent him home bent in disgrace.

## **"Tribute to Barbara"**

A ditty bag maker named Gary  
Was lucky enough just to marry.  
    His knotting obsession  
    Came close to aggression—  
Most women would find it quite scary.

## **From Anne Dyer,**

There was an old bragger called Dai  
who believed he could all knots untie.  
    He said "lend me a rope",  
    (the big-headed dope).  
We will go let him out bye-and-bye.

This story may well strike a chord,  
for whenever I unwind a cord,  
    It gets in a knot,  
    Which annoys me a lot  
Never maker and string in accord.

## **From Jane Kennedy,**

The girl with the hood coloured red  
Tried to tie up the wolf to the bed,  
    In the honest belief  
    That she'd used a reef,  
But she found she'd a Granny instead.

**From Maurice Smith,**

A skilful knot tyer called Ken  
Tied miniature knots in his den  
    The girls had no fears  
    With these in their ears  
It made them feel safe from their men!

There was a Guild member called Sid  
Who worked with a spike and a fid  
    His bellropes were bitty  
    And not very pretty  
So he sold them all off for a 'quid!'

**And from "Hank"**

There was a Guild member in Wales  
Who liked to go sailing in gales  
    He knew all the knots  
    And tied lots and lots  
And his sheets stayed attached to his sails

When climbing aboard from a tender  
Jack placed both his legs round a fender  
    He slipped with a crash  
    And made quite a splash  
And they say that he even changed his  
gender!

# Millenium Knots

In the last issue of Knotting Matters, we published details of some of the postcards received by Ken Yalden, of the knots tied to celebrate the new Millenium. Here is a list of the remainder of those cards.

All the postcards received along with your samples of knotwork will be displayed at the Guild's 20th Birthday celebrations, due to take place in 2002.

Plans are already underway for the birthday celebrations, which will take place at Ferneham Hall, Fareham, Hampshire. There will be a whole week of knotting displays and demonstrations, culminating in our 20th Birthday party on 25th May 2002. Further details will be published in due course.



NAME	PLACE	COUNTRY	KNOT TIED
Elliott, Ken	Emsworth, Hants	England	4L x 3B
Foulger, Richard	Brighton, W Sussex	England	4L x 3B on shaft of rope with monkey fist & eye splice
Fraser, Brian	Leamington Spa, Warcs	England	5-part Star (crowned)
Hall, Tom	Lonetree, Wyoming	USA	3L x 4B
Murphy, Denis	Plymouth, Devon	England	4L x 3B
Colonnese, Domenico	Amalfi	Italy	
Taal, Willem F	Scheveningen (The Hague)	Nederland	7L x 4B
Hagger, Dave	Black Rock ?	England	4L x 3B
Stroud, Bob (R.F.)	Dover, Kent	England	4L x 3B
Thomas, M	Loftus	England	4L x 3B
Bluck, E A	Poole, Dorset	England	4L x 3B
Collins, Anne	Henfield, W Sussex	England	4L x 3B
Dingley, Ted	Sandwich, Mass	USA	4L x 3B
Jones, Tony	Bissau		4L x 3B
Danes, Arild	North Sea		4L x 3B
Weil, Page	Turtle Run Campsite, Leesburg, VA	USA	4L x 3B
Fraile, Luis Gilperez	Sevilla	Spain	4L x 3B
McDougall, Forrest	Pictou, on board yacht	New Zealand	4L x 3B
Tyrall, Charlie	Ebernoe, West Sussex	England	5L x 6B
Budworth, Geoffrey		Planet Earth	Angler's (or Perfection) Loop
Walker, Ron	Denton, Texas	USA	4L x 3B
Willaert, Willy		Belgium	9L x 8B TH
Orrah, Robert	Richmond	New Zealand	4L x 5B
Ridings, Terry	Saltspring Is, Br Columbia	Canada	4L x 3B
Bagai, Eric	Portland, Oregon	USA	One-handed, flying slipped overhand knot
Bahn, David S	Ithaca, New York	USA	4L x 3B
Burgiel, Gay	Philadelphia, PA	USA	Rolling hitch
Parker, F A	Guildford, Surrey	England	4L x 3B
Dovey, Paul	Portsmouth, Hampshire	England	Fireman's Chair Knot
Lewry, Don	Funchal	Madiera	4L x 3B doubled once

NAME	PLACE	COUNTRY	KNOT TIED
Williamson, Clive	Ruabon, Wrexham	N Wales	4L x 3B
Gray, Robin	Ascot, Berkshire	England	Monkey's Fist
Newey, Bill & Joyce	Dudley, W Midlands	England	4L x 3B
Gowing, Geoff	Sydney Harbour	Australia	Thump Mat
Lauwereyns, Marc	Blankenberge	Belgium	4L x 3B
Monk, David	Chobham, Surrey	England	4L x 3B
Kuiper, Klaas	Delfzijl	Nederland	4L x 3B
Brookes, Bill	Bronllys, Powys	Wales	4L x 3B
Jackson, Simon	Southampton, Hampshire	England	4L x 3B
Scott, Peter	Chippenham, Wiltshire	England	4L x 3B
Dyer, Anne	Westhope, Shropshire	England	Tassel Mat
Riddle, Roger	Bexleyheath Scout HD, Kent	England	Clove hitch - 2 hitch knot Ashley 2270
Robson, Ray	Stafford	England	4L x 3B
Bodger, Penny	Osgathorpe, Leics	England	4L x 5B
Evans, Paul L	Palma, Majorca	Spain	4L x 3B
Lees, Michael	Salterns Marina, Poole, Dorset	England	4L x 3B
Meakin, W J	Hucknall, Nottinghamshire	England	4L x 3B (x 4) 2-colour bump mats as coasters
Burrhus, Kenneth (Snr)	Woods Hole, Mass.	USA	4L x 3B Ashley 1311 method
Blandford, Percy	Newhold on Stour, Warcs	England	4L x 3B
Court, Gordon	Weston Super Mare, Som	England	4L x 3B
Pepkowitz, Leonard	St Simon's Island, Georgia	USA	4L x 3B
Cockburn, Norman	New Maske, Redcar, T & W	England	4L x 3B
Crabbe, Ian	Chigwell Row, Essex	England	4L x 3B (x 5 into a Celtic Cross)
Priddy, Allen R	Pocatello, Idaho	USA	4L x 3B
Chang Dawson, Europa	E Hanningfield, Essex	England	4L x 3B As part of a 5-in-1 interlaced TH
Bernst, Jody	Thunder Bay, Ontario	Canada	4L x 3B
Lofty, John	Chesterfield, Derbys	England	4L x 3B
O'Hagan, Mike	Stonehaven, Aberdeenshire	Scotland	5L x 3B (Ashley 1307) on a bight : 8 str sq sennit (Ashley 3001)
Paul, Keith	Clapham, Bedford	England	4L x 3B
Dyron, Peter	Gosfield, Essex	England	Clover hitch and sheet bend

NAME	PLACE	COUNTRY	KNOT TIED
Brown, Frank	Tasmania	Australia	4L x 3B
Escudiero, Paulo	Cacem	Portugal	4L x 3B
Darwin, John	Fairhaven, Mass	USA	4L x 3B
Kennedy, Jane	London	England	4L x 3B twice reversed to form 2000 (MM) Pendant
Patterson, James G	Garsley, Gloucs	England	4L x 3B
Peake, Murray	Discovery Bay, Victoria	Australia	4L x 3B
North, James W	Bexley, Kent	England	3L x 5B
Peters, Mike	St. Ives, Cornwall	England	4L x 3B
Watson, Terry	Terrington St Clement, Norfolk	England	4L x 3B
Higgs, Ken	Felixstowe	England	9L x 8B in dk grn 3mm cord on a 3" core
Best, Peter	Ipswich, Suffolk	England	4L x 3B tied around a Mag-Lite torch
Southerden, Albert	Chelmsford, Essex	England	4L x 3B tripled (red, white & blue)
Osborn, Bruce	Atlanta, Georgia	USA	Eddie's Butterfly and Unity knots
Gallagher, David	Zenda, Wisconsin	USA	4L x 3B
Keating, James F	Marblehead, Mass	USA	4L x 3B
Scott, Wally & Blanch Sawyer	Thorold, Ontario	Canada	4L x 3B
Keens, Bob	Dunston Holme, Norfolk	England	4L x 3B
Johansson, Sten	Stockholm	Sweden	4L x 3B
Schmidbauer, Joseph	Corona, California	USA	4L x 3B
Turley, Bruce	Birmingham	England	4L x 3B
Smith, Graham	Scammonden Activity Centre, Huddersfield	England	4L x 3B
Biggar, D	Hixon, Staffordshire	England	4L x 3B
Learwood, Derek	Merstham, Surrey	England	4L x 3B
Blake, Michael	Hastings, East Sussex	England	3L x 4B Turkshead toggle
Weeks, Terry	Brewers Quay, Weymouth, Dorset	England	4L x 3B
Greene, Edward	Long Island, New York	USA	3L x 4B on a wooden dowel
Sheahan, Jack	Riverglade, Upper Hutt	New Zealand	4L x 3B
Denyer, Howard	Guildford, Surrey	England	4L x 3B
Pearce, R	Botley, Hampshire	England	4L x 3B
Wyatt, Jeff	Dunstable, Bedfordshire	England	5L x 6 Turkshead converted to a gaucho weave

# THE KNOT TYER'S JARGON GENERATOR

from Jack Fidspike

The notion mooted by our IGKT Council to publish from time to time a learned journal is a sensible one, and I urge all those members who can do so to submit articles and thus make it a success. Provided, that is, they cultivate a lucid and intelligible style for the rest of us to read. Avoid the over-scholarly approach of wrapping up the message and meaning in

a dense fog of long sentences and jaw-breaking academic words. We can all play that game, as the following exercise demonstrates.

From the grid below, pick any three numbers (0-9) at random; then, to generate a pseudo-scientific phrase, simply replace the digits with the corresponding words from columns A, B and C in that order.

A	B	C
0 Ashleyic	Anachronistic	Didacticism
1 Dayic	Heuristic	Doctrinarism
2 Graumontian	Holistic	Empiricism
3 Henselian	Paradigmatic	Epistemology
4 Leverian	Pedegogical	Hermeneutics
5 Naresian	Protagonistic	Iconography
6 Popplean	Quietistic	Intrinsicity
7 Shavian	Stochastic	Positivism
8 Smithian	Syllogistical	Systemisation
9 Spencerian	Teleological	Taxonomy

Examples:

082 Ashleyic syllogistical empiricism

294 Graumontian teleological hermeneutics

Specimen usage *'In an effort to render knot tying theory into practice it is tempting to prefer Ashleyic syllogistical empiricism to the less attractive but equally valid Graumontian teleological hermeneutics.'*

Caution

Beginners should not attempt to generate more than two such phrases in a single sentence.

Acknowledgement: I am indebted to R.S. Steel, a senior lecturer at SELtec (South East London Technical College), who discovered and reported the first jargon generator, which he always mischievously credited to the renowned Eastern bloc academician and educational dissident L.T. Lubish. (Actually the name and initials are an anagram. Work it out.)

# Book Reviews

## **The Forensic Analysis of Knots and Ligatures by Robert Chisnall, B.Sc., B.Ed., M.Ed.**

Published (2000) by the Lightning Powder Company, Inc., Salem, Oregon, USA

ISBN 0-9622305-2-9 Price: not known at time of review

This handsome 28.5 cm x 22 cm (11¼ in x 8½ in) hardback book deals with knotted cordage clues discovered at scenes of crime. The Canadian author - a founding member (and past-president) of the IGKT - is uniquely qualified and experienced to write this expert dissertation on salient practical and theoretical aspects of knotting pertinent to the forensic investigation of crime. In it he does more than merely collect and collate a book-full of raw data. He distils it until it drips processed intelligence, then flavours this distillation with original observations and personal insights. I wish his advice on appearing in court to give evidence, as an expert witness had been available when I first ventured to do so.

The book begins with 14 pages of prelims, including - I must declare my personal involvement - a written preamble from this reviewer. The next 157 pages are sub-divided into seven chapter headings, namely: introduction; basics; acquisition and preservation of evidence; observation and evaluation of evidence; analysis of evidence and conclusions; qualifications and testimony; research. It

concludes with a glossary, bibliography, author's CV and index.

Robert Chisnall's worthwhile publication is a training manual, a reference book, and a fascinating read. I recommend it to all dedicated students of knotting (quite apart from the minority who already practise - or are considering - this unusual field of endeavour).

*G.B.*

**CREATIVE ROPECRAFT - 4th Edition By Stuart Grainger.** Published by Adlard Coles Nautical, London. Paperback 124 pages. £8.99. ISBN 0-7136-5377-9

It was 25 years ago that *CREATIVE ROPECRAFT* by *Stuart Grainger* first appeared in print in the UK. There had been nothing like it before. The beautiful drawings, so clear and easy to follow, were a joy. In 1977 the American edition was published, and remained available long after the first British edition had sold out; before it too finally finished. Barnacle Marine published a 3rd edition in 1991 which has just sold out. Now, just when it appeared that the world would be deprived of this important knotting book there is a 4th edition.

The book, after a brief touch on everyday knots and splices, goes on to cover those things that most other books fail to cover clearly; Turks heads, sennits, and multi-strand knob and lanyard knots, as well as covering techniques such as

needle hitching, grafting and cross pointing, together with a few mats. Stuart's drawings are so crisp and clear that the likelihood of going wrong is greatly reduced and subtle variations can be understood. They are drawings for those that wish to use knots to make and cover things in a creative way. The book finishes with a selection of projects, starting with a very simple lanyard and going onto a hammock, a lamp base, a tray, and a doorknocker (or a single chest becket).

For this 4th edition Stuart has added just a few more very useful things, especially the Star Knot Grommet that can be used on its own "as a bangle, napkin ring or candle holder and invaluable for basket rims and bases, as well as providing frames for photos, mirrors and trays". His special development the multiple crown for covering of the end of a rod or cylinder is also a useful addition. There is an extra mat and the addition of Hunters Bend and the Boa knot. Sadly the two pages of black and white photos of finished items made by Stuart have been dropped, instead the publisher has replaced by them with coloured photos on the cover, but for me somehow they are just not the same. Readers of Knotting Matters are lucky that they can enjoy Stuart Graingers artwork on the front cover of every Knotting Matters. Anyone who has not got a copy of this book should get one immediately. If you already have one, is there a friend you can buy a copy for? I am sure that they will be pleased to receive a copy of this special book.

*Des Pawson.*

# Knotmaster Series No. 7

*"Knotting ventured,  
knotting gained."*

## **1 - Marline(or marling)spike hitch**

This is the classic knot for levering tight all sorts of seizings and servings or bindings. Lay out an uncompleted overhand knot and insert the fid or other implement (fig. 1a). Alternatively, ask an able Guild member to demonstrate tying this hitch in one fluent flourish with the tip of the tool. Carefully secure the knot before use (fig. 1b).

## **2 - Pile (post or stake) hitch**

Knotmaster prefers a pile, post or stake hitch and any makeshift handle. Ensure the short end is closest to the bight (fig. 2a); otherwise the knot is unreliable. Tighten before loading it (fig. 2b).



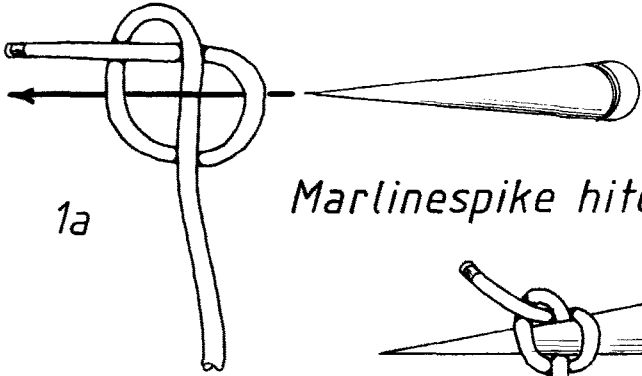

1a

*Marlinespike hitch*

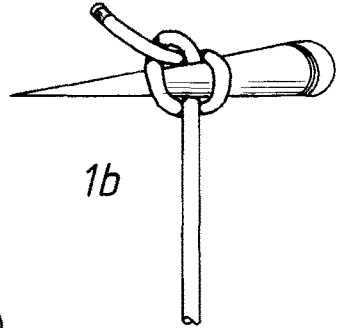

1b

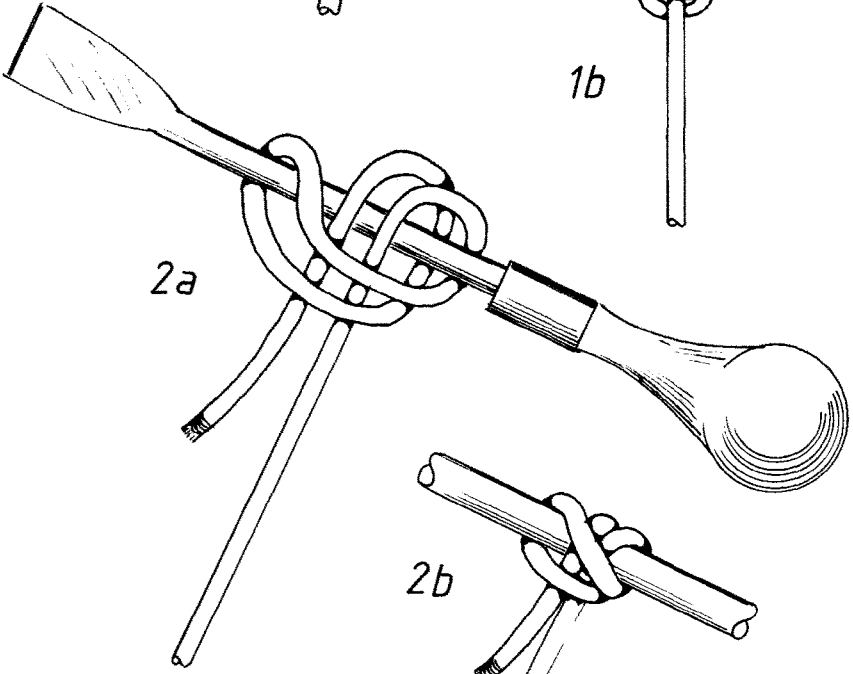

2a

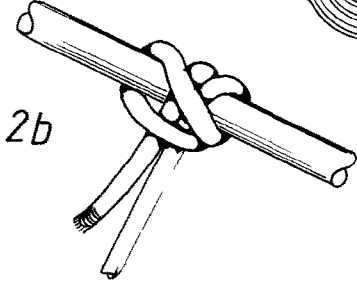

2b

*Pile hitch*

# A Comment on Knot Slops

by Charles Warner

**D**an Lehman has written a fascinating article in KM 66 and suggested a ‘Millennial Offer of Purpose’. I wholeheartedly agree with the general tenor of his remarks; indeed I think the IGKT could do a lot more than it has to ‘establish an authoritative body for consulting purposes’. Maybe the Knotting Journal proposed by Tony Doran in the same issue will be an early step towards this end. Meanwhile Dan makes a number of things sound easier than they might turn out to be, and I would like to give some detailed comments.

Much of Dan’s article is a plea for people who want to talk or write about knots to give the evidence or basis for their opinions. As Dan says, ‘one often reads “this is to be preferred...” but seldom is that complemented by”... because... “: All of us are guilty of this at times and we should try to improve matters. Indeed, Dan himself needs to be a bit more careful: he gives at least three opinions in this article without any basis stated: on the inferiority of the Zepplin/Rosendahl Bend (p 11), the strength of TCB Knots and Loop #7 (p 12) and the security of the Heddon Hitch (1) 13); he may well be correct, but what led him to those opinions?

## **Illustrations of Knots**

Illustrations of knots, from the very

earliest knot books of the last century, rarely show the knot ready for work after drawing tight, they show some open structure which shows just which part goes where. The reason is not only that it is ‘easy on the illustrator’, but that so many illustrations would be needed. Even the simple Figure Eight Bend and Loop needs at least two (front and back). With more complex knots, even with the tightly tied knot in my hand I have often found it impossible to identify the knot, or tell whether it is tied correctly, without much handling, including in many cases loosening off some of the parts. This sort of thing is difficult to show in an illustration.

It is true that it would be possible to show the knot in the form just before finally drawing tight, but that gives the knoter a lot to remember, just which bit goes where. I at any rate prefer to learn by making a simple easily remembered version of the knot, such as the flat form of the Figure Eight Bend/Loop, and then applying the general rules for tightening any knot. First dress the knot by arranging it to give all parts smooth curves without twists or kinks, that is with minimal torque within the rope and the most direct transfer of internal forces; then pack it optimally, tighten in such a way as to avoid any deformation when the load is applied, often best achieved by holding the knot

in one hand and using the other to tighten each emergent end in turn, again and again until no further movement occurs (in complex knots internal parts may have to be worked tight through to the ends first).

These general rules seem to be applied automatically, without conscious thought, by most careful users of working knots subject to heavy strain, including many climbers and cavers, but they are rarely spelled out. Indeed, even if they are written down, I am not at all sure that anyone trying to learn knotting out of books will pay attention to them. In my book *A Fresh Approach to Knotting and Ropework* (1992, self-published) I devoted a whole chapter to how to tie knots, including tightening. I have had many comments, favourable and otherwise, about aspects of this book, but never a word about this chapter.

### **Names of Knots**

Dan is confused by several different names being given, more or less indiscriminately, to several different forms or applications of some climbing or caving knots. This is a common situation in the world of knots. There is no academy of knots that decrees which name should be given to which knots. A recent knot book, *Great Knots* by Derrick Lewis (Sterling, 1998) lists alternative names for many traditional and recent knots. The record is held by the Cow Hitch, which has a round dozen alternative names, but more than a fifth of the knots in the book are given three or more names.

As for the Klemheist/Heddon / Kreuzklem knot that worries Dan, he should remember that these friction

hitches are very simple and quite easily developed by anyone as variants of known knots. It is very likely that this knot was developed quite independently, with no knowledge of the other work, on several occasions. It was not common in the caving and climbing communities for people to rush into print with their 'new' knots. Knots were often in use for years in limited regions before someone, not necessarily the original developer if such a person can be identified, described the knot in some club newsletter, usually without any great thought as to what name, if any, to apply. It might take several more years before the knot and an associated name acquired widespread recognition and then several more years or decades before the knot appeared in the general knotting literature.

Which way up should the knot be, or which bight should be inserted into the other? I think it can be taken that both ways work sometimes. There is a lot of slop in the knot, so there are many ways to present it. It would be easy to try some variant, strike trouble and report the knot as insecure, without studying all possible variations in the exact way in which to tie the knot. Sometimes someone with more interest in knots as such than the average climber or caver may make such a detailed study. I don't know off-hand whether anyone has so studied the Klemheist/Heddon/Kreuzklem knot; maybe Heinz Prohaska would know (he has made detailed studies of many climbing knots).

Writers of general knotting books should not be expected to have detailed specialist knowledge of the finer points

of the applications of all the knots they describe. So far as I know, neither Geoffrey Budworth nor Des Pawson has any significant climbing or caving experience, so they can only report what other people say about the specialist knots. If the specialists can't be bothered to make and publish thorough studies of their knots, I don't think Geoffrey or Des should be greatly blamed for a bit of confusion. I don't own either of the books referred to, but I hope that both contain somewhere statements to the effect that the books describe only knots and those details of their application should be learnt from specialists.

You really can't learn everything there is to learn about making and using knots out of any single book. Even a whole library of books is no substitute for a teacher experienced in the special field, and personal experience oneself.

Should the IGKT try to do anything about the confusion of names for knots? We quite certainly will not persuade the staunchly individualistic tradespeople, hobbyists, sailors, farmers, climbers, anglers and others who use knots to give up their favourite names. The best we can hope for is to develop and popularise 'official' names for knots so that writers can follow the example of naturalists and give 'common' names that might well be used only in restricted areas, plus the 'official' name that is hopefully recognised world-wide. But it would be a long and thankless task and I don't think much of our chances.

### **Strength of Knots**

Dan seems worried that published figures

for the breaking strengths (or knot strength efficiencies) of particular knots seem to vary a lot in different accounts and surmises that careless tying of the knot may be an explanation. Indeed that is possible—there is one account that states that neglecting to minimise internal twists and kinks in a knot may as much as halve the measured knot strength. But many accounts of the actual testing of the knots show that considerable care was taken in tying the knot. Even then, one investigator of climbing ropes said that he 'found it impossible to tie a Bowline in exactly the same manner, no matter how proficient we were', and another, this time working with fishing line, said that he 'often required some hours of practice' before he began to get results 'so uniform that they were worth including in the record'.

There is at least tentative evidence that the measured strength of knots is influenced by:

- (i) the nature of the rope in which it is tied (fibre, detailed structure, and size)
- (ii) the ambient conditions (wet or dry, perhaps temperature, humidity)
- (iii) the conditions of the test (rate of increase of load)
- (iv) the nature of the knot and the way in which it is tied.

In several series of tests, each by the same investigator so that it is probable that the knots were tied in comparable ways, it has been found that there has been more variation in the results due to the nature of the rope used than due to the nature of the knot itself. There have been fewer tests of the other factors mentioned to be sure

of the magnitude of their effects. Note that these extraneous factors affect not only the magnitude of the breaking strength of the knots as measured, but also the ranking order of the different knots. Thus in one collection of tests, the measured breaking strength of the Bowline varied in different tests from 52% to 78%, and that of the Overhand Loop from 49% to 80%, yet in one test using laid nylon climbing rope the Bowline had a strength 16% greater than the Overhand Loop, but in another, using flax cord, the Overhand Loop was marginally (2%) stronger than the Bowline.

We cannot say even that knots weaken rope in all circumstances. In some tests with repeated shock loads due to a falling weight, some knots have prolonged the life of the rope as if they had made the rope stronger. Presumably they had acted as shock absorbers.

My conclusion from all this is that we cannot expect to get a single figure or even a narrow range for the breaking strength of a particular knot as such; so much depends on the material in which the knot is tied, the ambient conditions and the way in which the breaking load is applied. The best we can hope for is a reliable figure applicable to some particular common circumstance. So far, we are a long way from that happy state.

Note that most of the laboratory tests were made using brand new rope and involved either a steadily increasing load, perhaps simulating an overloaded winch, or a shock force simulating a falling body. Yet most knot failures in practice involve ropes that have already been subjected to

a variety of loads and, quite often, to some degree of abrasion or weathering; on many occasions the force that actually causes the break is a relatively small jerk on top of a more or less steady pull. Such laboratory tests can be expected to give only a rough guide to the behaviour of the knots in practice. Rope is a very complex substance, still little understood, and tying knots in it only makes it more complicated.

Dan has two suggestions on how the IGKT might 'reduce the slops' in the study of knot behaviour. One is a compilation of the extant literature. While I know full well that it would be possible, on a world-wide scale, to multiply my examples many times, I very much doubt if the general picture would be any clearer in the end than in my own 25-page, 36-reference chapter 'Studies on the behaviour of knots' in the *History and Science of Knots* (editors JC Turner, F van de Griend; 1996, World Scientific Publishers), the source of most of the data quoted here. A more complete compilation would be interesting, but would it be worth the very considerable labour needed?

The second suggestion is that the IGKT should itself test and report on the behaviour of knots. It is certainly highly desirable that someone should make tests 'in which the experimental conditions are carefully described so that others may repeat the tests exactly; and an adequate number of replicates are made so that confidence limits may be calculated. The position and nature of the final break should be described' (quoting the conclusion of my chapter). If we are

interested in the behaviour of working knots used in industry, climbing, sailing etc we must test full-size rope, not light lines. It is doubtful, therefore, if homemade testing apparatus would be satisfactory or even possible, applying and measuring loads exceeding a tonne. Almost certainly, proper materials and testing apparatus would be needed, which would be expensive even to rent.

And a lot of rope would be needed. I once met a lady who was testing the strength of knots in climbing rope for the rope manufacturer. At the time I met her, she was only part way through her studies but she had already used up a couple of kilometres of kernmantle rope with a retail price of several dollars per metre. I lost track of the lady; I don't know if she ever finished her study, or if the work was ever published anywhere or if it is still held in the commercially confidential archives of the company.

One way to obtain reliable results over a range of materials and knots would be to sponsor a post-graduate student working for a higher degree at a university or technological institute already equipped with the testing apparatus needed, for several years, with a generous supply of materials. Any program promising substantially cheaper expenses should be looked at very carefully so that it would not just increase the amount of sloppy data already in print.

In conclusion, thank you Dan for a stimulating article.

**Dan Lehman replies:**

I appreciate Charles Warner's interest in my "Slops" article (km66: 10), and here

respond to a few of his points. While indeed I offered cursory opinions of some knots without rationale, my article - unlike those and the books of which I wrote, was not itself primarily addressing knots, but others' texts about knots. Thus, my main obligation was to be accurate about what others say about knots i.e. each to his subject. In this, I remain unrepentant about taking authors to task for making careless and false statements about knots. (An egregious example of this is the book he cites - "*Great Knots & How to Tie Them*", by Derrick Lewis, which is replete with errors, including a plagiarised part Geoffrey's *The Knot Book*, rendered into nonsense!)

Charles seems to grant too much freedom for "slop", as though knot books merely present images, devoid of guidance as to what those images mean. On knot illustrations, it is simply not possible to proceed from the common "flat" diagram of a fig.8 to a particular tied form. Photos of in-use fig.8 knots from many sources show the diversity of results this ambiguity leads to a great deal of manifest slop! As for the issue of getting knots instruction from books vs. a teacher, one can go wrong in both cases. Either can be good or poor (many "teachers" tie sloppy 8s!).

Charles presents a look at the hard research done on knots, which by his account gives us only a limited understanding. It is my hope that the IGKT can involve itself in such research and greatly increase our knowledge of knots.

# Maya Ropemaking

By Richard Hopkins

I was looking at a children's book in the library about technology at the time of the Maya civilization. We are all familiar with traditional methods of yarn and rope making using spinning wheels and rotating hooks, and even with the still more primitive idea of rolling strands on ones thigh. The device shown in the article, however, was new to me so I enclose a drawing and summary of the method of use. It consists of a paddle shaped blade that is able to rotate around a handle. The paddle acts like a flywheel to aid rotation whilst the other end, to which the fibres are anchored, is arrowhead shaped.

The strongest fibre that the Maya used came from the agave plant. Its long leaves were pounded to loosen the fibres, then soaked until the fleshy parts could be scraped off. The resulting mass of long fibres, after washing to remove any remaining pulp, was combed out and left to dry.

A few of the agave fibres would then be tied around the arrowhead shaped end of the device. The ropemaker then walked backwards from the bundle of fibres, spinning the tool like a footballer's rattle, it was said that this was in an anti-clockwise direction. A helper would add more fibres as the twisted cord became

longer.

There would be one of these gadgets in each hand so two lengths of cord would be produced at the same time.

After about twenty feet or so had been made, the spinner would twist the cords together in a clockwise direction. I do not know if there was a mechanical means to do this, perhaps by transferring one cord to the other paddle and reversing the rotation, or if it was done by hand.

Further detail about making longer ropes was not available in the article I found, but if any members can give more information, I would be pleased to learn about it. I would expect the fibres to be moistened before spinning but the article said dry fibres were used so any suggestions on this would be appreciated.

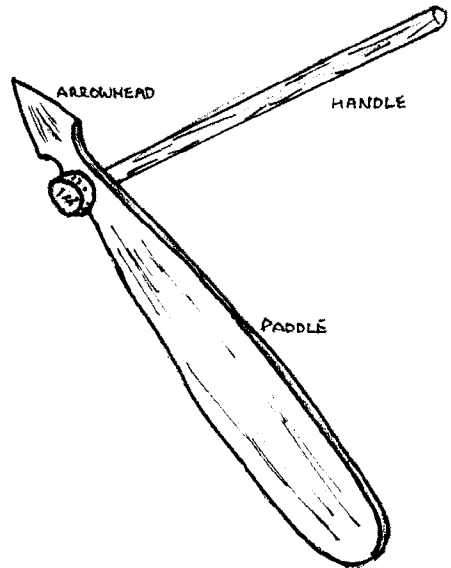

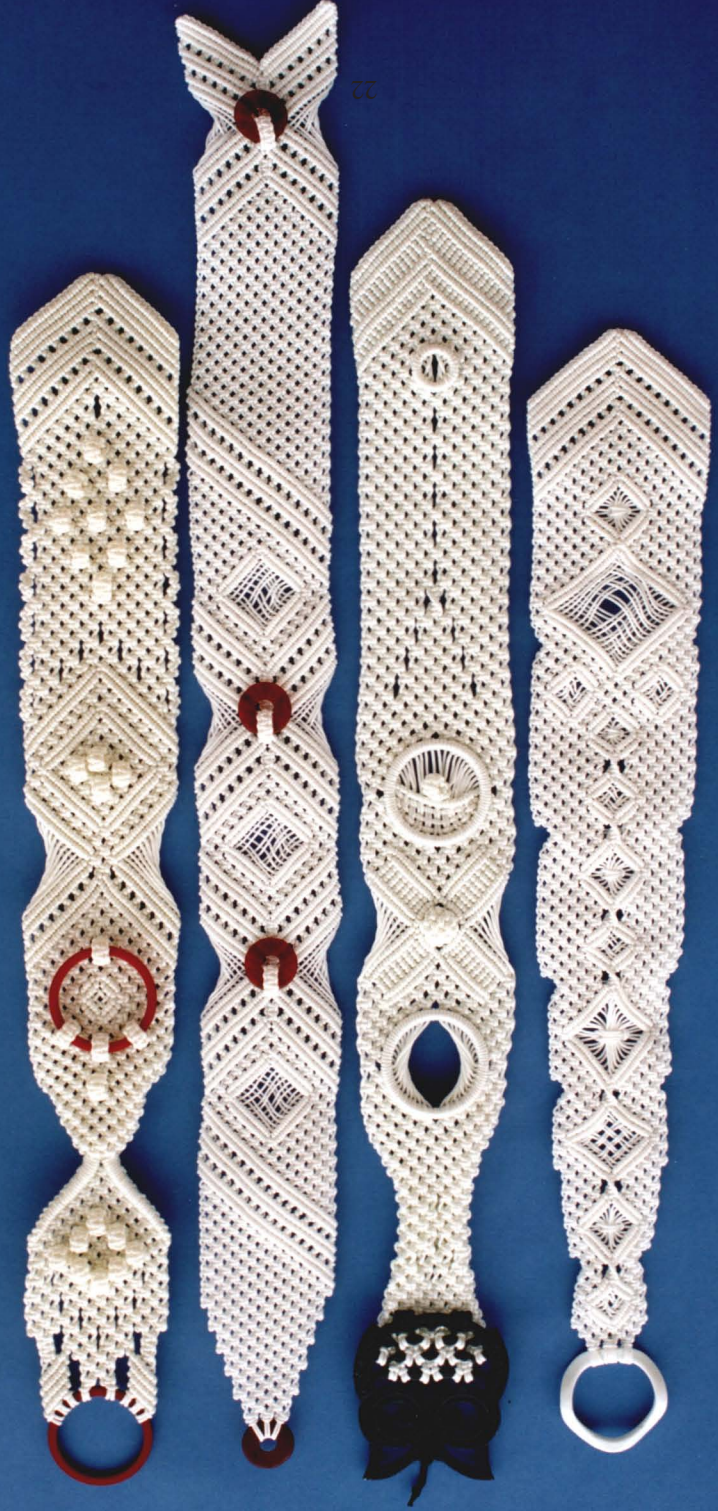



# Knot Gallery



*Above - covered bottles by Joachim Paulo Escudeiro*

*Left - a selection of macramé from the nimble fingers of Geoffrey Budworth.*

*Overleaf - sea chest becket by Ken Yalden*



# Bell Rope



by James L. Doyle



REEF KNOT



REEF KNOT



REEF KNOT



REEF KNOT



REEF KNOT

REEF KNOT



REEF KNOT



REEF KNOT



REEF KNOT



REEF KNOT



REEF KNOT



REEF KNOT



REEF KNOT



REEF KNOT



REEF KNOT



REEF KNOT



REEF KNOT



REEF KNOT



REEF KNOT



REEF KNOT



REEF KNOT



REEF KNOT



REEF KNOT



REEF KNOT



REEF KNOT



REEF KNOT



REEF KNOT



REEF KNOT

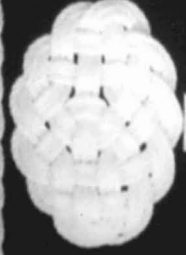

REEF KNOT



REEF KNOT



REEF KNOT



REEF KNOT



REEF KNOT



REEF KNOT



REEF KNOT



REEF KNOT



REEF KNOT



REEF KNOT



REEF KNOT



REEF KNOT



REEF KNOT



REEF KNOT



REEF KNOT



REEF KNOT



REEF KNOT



REEF KNOT



REEF KNOT



REEF KNOT



REEF KNOT



REEF KNOT



REEF KNOT



REEF KNOT



REEF KNOT



REEF KNOT

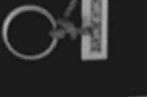

REEF KNOT



REEF KNOT



REEF KNOT



REEF KNOT



REEF KNOT



REEF KNOT



REEF KNOT



REEF KNOT



REEF KNOT



COMPASS

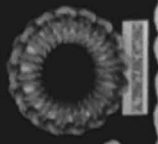

COMPASS



*Above - fine macramé belts on view at T.S. Weston (photo by Ken Nelson)*

*Left - knotboard by Alistair Ritchie. Size 24" x 18", with 58 knots plus a border of sennits.*

*Below - paper knife by Colin Grundy*



# A Sea Chest

by Daniel E. Smith

I have been a member of the IKG for 6 years and have carefully read all the Bulletins sent to me during those years. It has always been something of a surprise to see how little reference is made to Hervey Garrett Smith and his wonderful book *The Marlinspike Sailor*. Even though we have the same last name (which is the most common of last names) we are not related. For many years, because of my fascination for his book, I have wondered about his life's activities and whether he is from England or the United States? Maybe someone of the Guild might have the answer. During a New Bedford meeting three years ago, I did inquire but no one seemed aware of Smith's background or his present whereabouts.

Nonetheless, my purpose for writing is to share with other members the results of several projects Hervey's book has inspired me to undertake. In particular, one is shown in the pictures here. This sea chest was something that languished in the back of my mind for 10 years. Actually, my entire "career" in knot tying has been nurtured by 25 years of ownership of "*The Marlinspike Sailor*". The illustrations are so easy to follow. For any of our members with seamanship from the old days in mind, it is certainly a trip into the past. In fact, he continually refers to his uncle, father and grandfather as men of the square-riggers, sailing out of New

England. For this reason, I assume he was a native of that vicinity and grew up there. His dialogue and stories that explain the procedure for tying various knots used aboard ship is entertaining and humorous, not to mention the clear illustrations he uses to guide the interested reader.

One day after many years following his directions, I counted every piece I had so diligently executed and learned I completed 80 % of the projects included in his book. This included the hand shaping out of locust wood, the blocks for his "handy billy"! This was a frequently used piece of equipment aboard my Seawind 30 ketch that was destroyed during Hurricane Andrew in 1992. This special block and tackle was used many times to haul me to the masthead. It disappeared at that time and was never found.

After many years of casual study and perusing the details of how to construct the small sea chest - with the becketts attached, - I pledged a commitment to use my time in Florida this past winter to build it. My favorite woods are curly maple and teak and the combination of the two blending together might not simulate what the old salts used, but it would certainly provide me with a great measure of satisfaction once completed.

As Hervey suggested, you create the

beckets first - two of them - so they match. It is important to do this because as you progress you can view any deviations or improper turns then make the corrections. In my becket I laid out the correct length (13") of 1/4" in cotton line with eye splices included at each end. Then, the center area was covered with wrappings of canvas strips to build up the taper effect necessary to give a graceful look to the becket. Executing this part you need to remember a rope covering goes over the canvas, so general thickness must be kept in mind or it will turn out looking too bulky.

I put a common 3-strand cockscombing over the eyes and tied them at the ends with whipping cord. The material used is 1.8 mm braided polyester, white color. I prefer to work with cotton seining twine of various sizes since it doesn't slip like the synthetic stuff but my supply box told me I didn't have enough. The polyester was more readily available at that particular moment. I guess I was more than happy with the finished appearance of the polyester braid even though it was a bit out of touch with the "old nautical" look.

To cover the main part of the becket there were two choices - I tried them both, deciding one was

better than the other. You need either 8 pieces of white material 10 feet long or 16 pieces by 5 feet long to initiate the overhand grafting process to fully cover this length of becket. It seemed more manageable to get confused by the 8 pieces than to try wrestling 16 separate ones into a beginning or ending position.

Once secured, the long, patient overhand grafting work began. For the first 2", I used a single overhand turn, then switched for the middle section to a double overhand application. This requires diligence to feed them (two) over the warp, so don't be in a hurry. In other becket I have made, I have used a right crown Sennit, tied it off after a section then used a coachwhipping for the middle part. The Turks head would be used to hide the connecting points. But in this case I worked all the way through without any interruptions using the overhand grafting method, also known as Spanish Hitching.



A 5Bx3L Turks head covers the beginning and the ends of the grafting at the base of each eye splice. The intersection or junction, where changing from single to double, is concealed by a wider 5Bx6L Turks head which, with its added width, harmonizes well with the spread of the overall becket. Incidentally, in place of Turks heads of the same color (white) I selected a nice teal color. This introduced a pleasant, but subtle contrast against the dominant white rope and the elegant look of a varnished teak and curly maple chest. To attach each becket to the ends of the chest required a "bolt" that is held in place with a wooden cleat, in this instance fashioned from teak. The "bolt" has a manrope knot tied at each end with a space left in the middle for the width of the cleat. A fluted, leather washer is used to reduce wear on each of the rope surfaces as the handles are raised or lowered. To add rigidity to the "bolt" I inserted a short piece of PVC pipe before finishing the manrope knot on the other side. The rope strands used to construct the manrope knots feed through the PVC pipe. It should be the same thickness or slightly smaller than the slot cut in the cleat.

Before the chest was completed or the beckets attached, I applied 7 coats of Captains Z-Spar varnish, the high gloss stuff. This turned out looking as though the whole product deserved a place aboard the epitome of all sailing: vessels! But something was missing. The inside looked empty; a cavernous hole, besides I had no idea what I was going to do with this object of beauty! One of Hervey's philosophies is that any piece of nautical work undertaken by a sailor should have

some useful function on board ship. After carefully analyzing the matter, I thought of it - this artful piece of work would serve as a ROPE LOCKER! All of my rope materials would be stored in the chest. But first it needed a tray, a removable tray. This tray once constructed fit flush into the chest and has a piece of wooden dowel as the lift handle. The wooden dowel is removable and slides through the holes in each end but remains stationary while the tray is in place, locked in by the sidewalls of the chest. It permits 5 spools of small diameter rope to be stored, making it easy to reel off various lengths needed for rope work. Also, on the floor of the chest I "carpeted" it with a piece of Berber carpeting recently installed in our condo. There is plenty of room for larger balls of cotton or assorted lengths already purchased to be stored here. The stopper for the lid is a suitable length of 1/8" cotton with an eye splice at each end fastened by a couple of stainless steel eye straps.

The hinges holding the lid are heavy brass used for hatch doors aboard the modern yachts (from West Marine supply).

Yes, Hervey Garret Smith has provided many happy hours, enabling me to create a few pieces of nautical trivia that I hope will find their way down through generations of Smiths - on the "Daniel" side, that is.

Hangman, slacken your noose. Hangman, slacken your noose. Hangman, slacken your noose, Or.. .aaargh!!! <i>(Mock folksong performed by English comedian Jasper Carrott)</i>
--



# Fish Knot

By Europa Chang Dawson

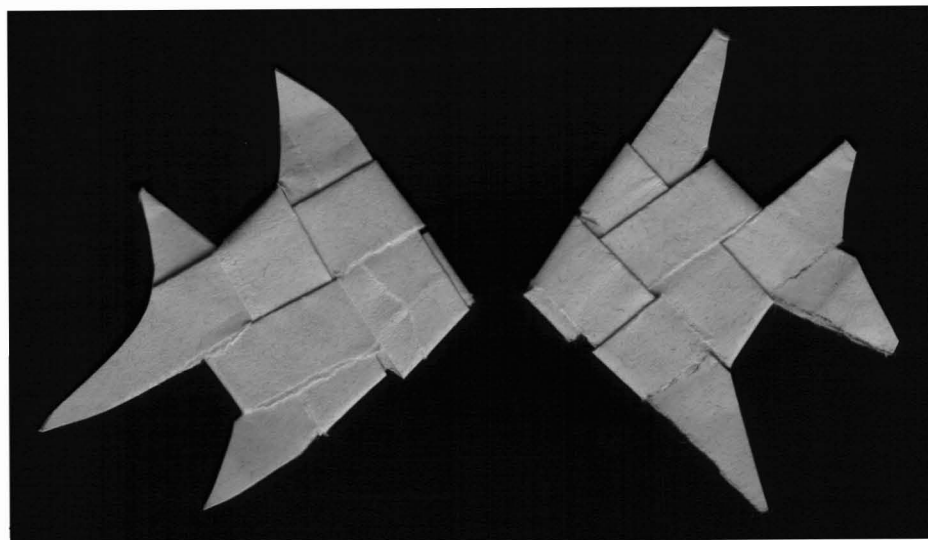

This Fish Knot, woven from two strips of paper is a very belated reply to a letter in KM 63. The easiest way is to use the sort of paper ribbon that comes with gift-wraps. You will need two strips, each measuring fifteen times the width of the ribbon.

\_\_\_\_\_

A A A A A A A outside B B B B B B B

\_\_\_\_\_

\_\_\_\_\_

a a a a a a a a inside b b b b b b b b b

\_\_\_\_\_

I

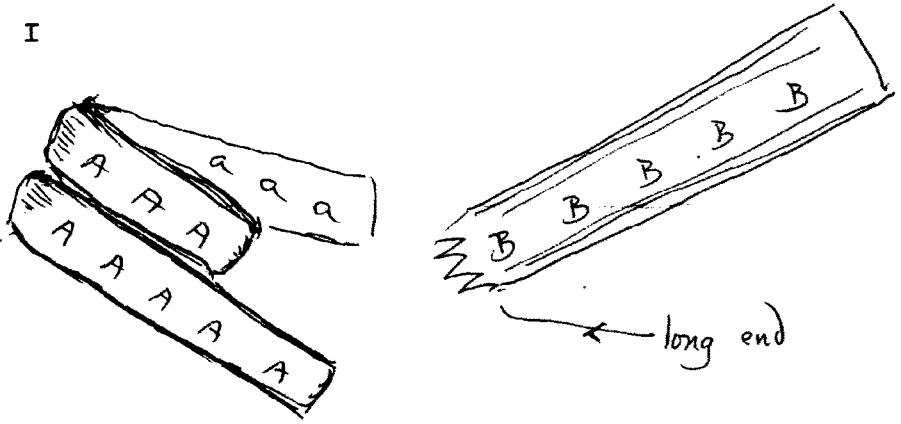

Coil strip 'A' twice around a finger or pencil. Do not fold it as the creases may come in the wrong place for the completed fish.

II

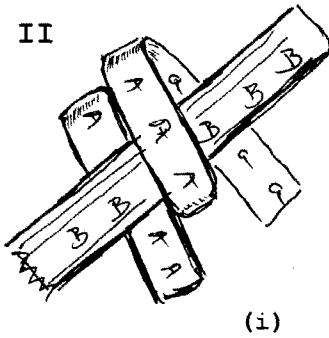

(i)

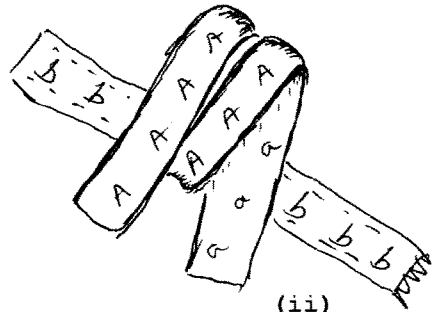

(ii)

Thread strip 'B' through as shown; then turn over to get this view.

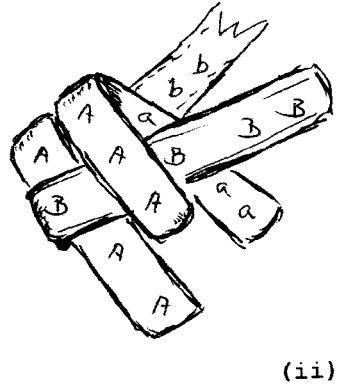
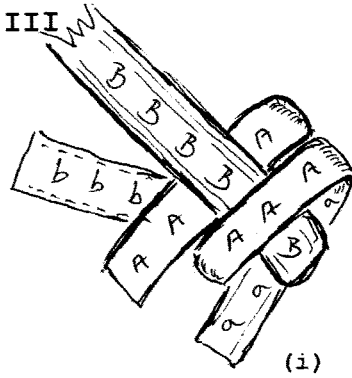

This comes from II (ii) Thread strip 'B' through and turn over to get (ii).

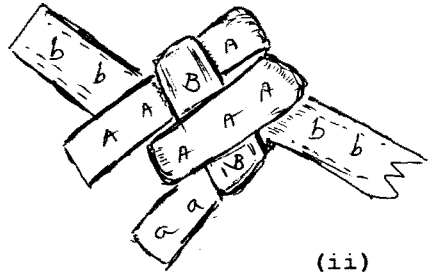
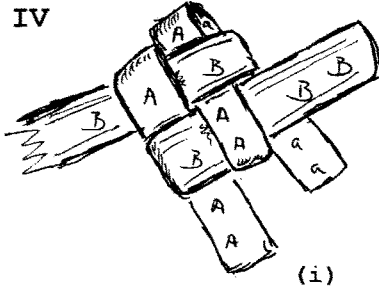

This comes from III (ii); turn over again.

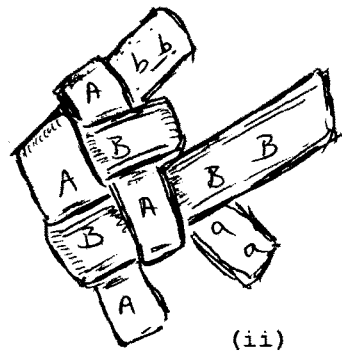
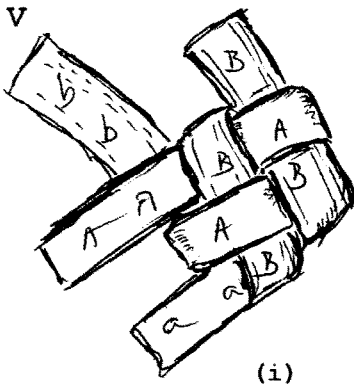

(i) Complete the last tuck. (ii) This is the other side.

Ease the paper strips round until the weave is as tight as possible. Flatten the fish shape, and trim the fins and tail.

# The Turk's Head Conundrum

by Peter Corcoran

## **A** solution for the Turk's Head Conundrum or

**Turk's Heads of many weaves simply  
and speedily made.**

With the greatest respect for:

1. Chas. L Spencer who started me fiddling with cord in the first place.
2. C. W. Ashley who bewildered me and left me in total awe of his work.
3. The mathematical treatises, that, I'm afraid, left me cold.
4. Harvey who befuddled me with Bases and Formulae A & B.
5. The many other intriguing articles, diagrams and methods I've come across to demonstrate and explain the SINGLE CORD Turk's Head, not least being Charlie Smith's amazing fingers.

I presume to propose and publish that: -

A. To make any size of single strand Turk's Head of any one weave (e.g. "Over 1 under 1" or "over 2 under 1 over 1 under 2" etc.,) there is a need for only one template and four simple rules. For each of these templates, the same rules apply.

B. No counting, other than for size determination of the required Turk's Head, nor memorising of sequences of overs and

unders, nor numbering of turns or crossings required.

C. All of these single strand Turk's Heads can be reduced to two types: -

"Even" - Those with an even number of parts

"Odd" - Those with an odd number of parts.

D. Multiple strand Turk's Heads, where the highest common factor between the numbers of turns and of parts gives the number of strands, can be made on the same templates using the same rules (as can mats but using slightly modified rules).

If the method described herein is not new I should appreciate a note advising me of the original source.

## **DEFINITIONS: -**

Total confusion exists in the literature in naming the component parts of Turk's Heads.

**Turns** are synonymous with Bights.

**Parts** are synonymous with Leads, with Strands, incredibly also with Bights and would you believe, with Turns!!!

I use Spencer's

**Turns** being the changes in direction of cords at the top or bottom of tubular Turk's Heads, i.e. at the rim.

**Parts** being the number of strands crossed or cut if we count vertically from rim to rim of a tubular Turk's Head of single ply. We would thus count as 1 the group of strands that comprise a multiple ply.

The terminology convention adopted herein is: -

A) Weaving is done from left to right

B) TOP and BOTTOM refer only to the farthest part from the weaver of the template, and the corollary.

C) GOING UP and GOING DOWN refer to the cord being led towards or away from the top of the template respectively.

D) OVER and UNDER refers to cords crossing each other within the weave.

E) GOING ABOVE a guide peg is either

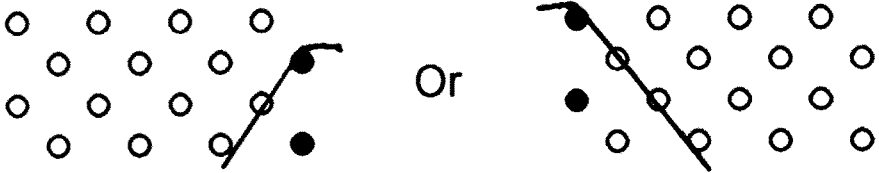

*GOING BELOW a guide peg is either*

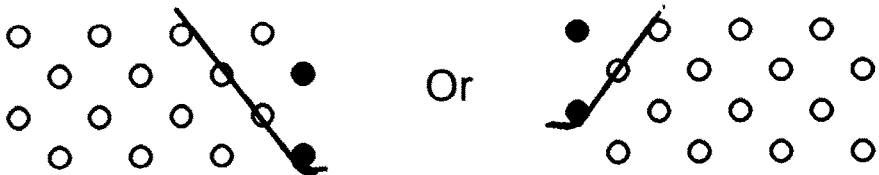

F) NEXT HIGHER and NEXT LOWER refers to the adjacent horizontal rows to that guide peg on the right.

This article describes a flat template and the method of using it to produce single strand tubular Turk's Heads of any feasible size (see Ashley), and of over 1 and under 1 weave.

While a sheet of plywood and tacks have

been used, as have pegboard and Pegs.

I use various sizes of Perspex sheet, one of which I describe.

Because flat templates require large amounts of cordage, it is often advantageous

A) To use shorter lengths of old stuff as a trace till the weave is closed in somewhat, or

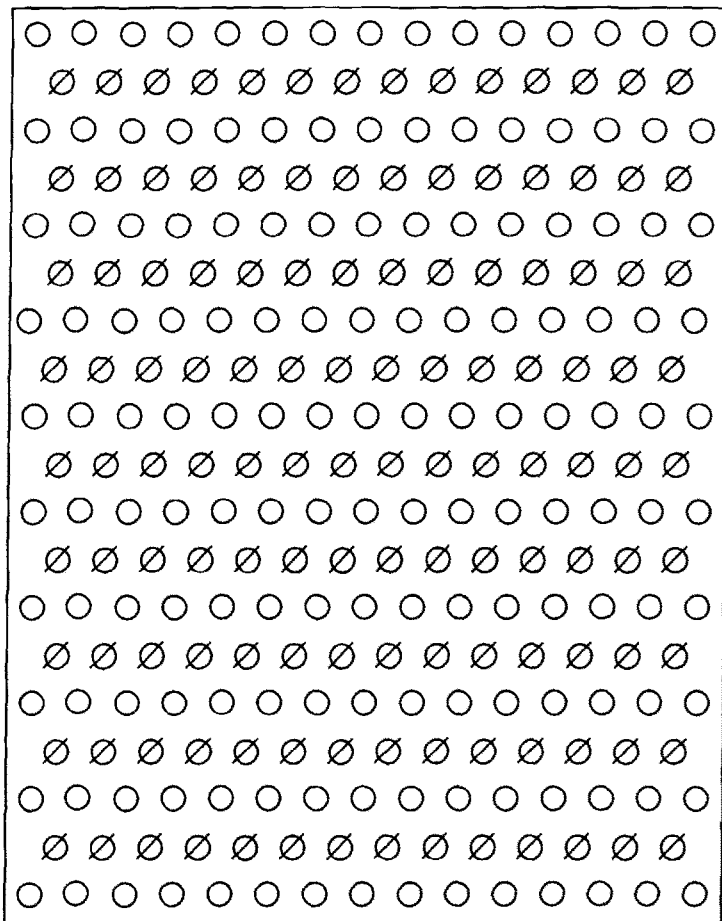

Fig. A  
Perspex Template

B) to use a template of a size that just accepts the number of turns one requires, or

C) To use a tubular type template having a cut-away segment so that it can be slipped about e.g. a mast, handrail, etc., and the same method and rules as set out herein.

For any other weave, whether: -

SIMPLE - "over 2 under 2" or "over 3 under 3" etc.,

COMPOUND - "over 2 under 1 over 1 under 2". Etc., or

COMPOSITE - interlacing of different Turk's Heads.

Only the engraving of the template need be different, or, in the case of the latter, both the hole pattern and the

engraving need be different. The rules remain the same.

### **The Template**

I use sheets of 2mm thick clear Perspex (and pop-rivets for pegging out. I use pop-rivets having 3mm diameter heads and to get an interference fit in the hole, drill these using 3.2mm drill bits.

Drill holes in rows parallel to the top edge at 14mm centres and 14mm apart vertically.

Drill further rows 7mm to the side of and 7mm lower than the original holes. A sheet of 21cm by 14cm will allow one to weave Turk's Heads up to 13 turn 18 part, or, if turned sideways, an 8 turn 27 part one.

Larger weaves are done by using extra templates together. Four of the above sizes have been used to create a 52 turn 17 part Turk's Head about a barrel. The above hole spacing allows comfortable weaving using up to 5mm soft braided cord. For larger cords I first weave with FLYLINE to make a trace. Each hole represents either a turn; a crossing point or it takes a guide peg, explained below.

Using either an engraver or a burr in a mini-drill, mark the over cord, but only in one direction, along every second row of holes, say for the lower left to upper right direction cords. The unmarked holes will be where the over cord is always in the other direction.

The removal of pop-rivets can at times be difficult, due to their collar, if the weave becomes too tight. In this case begin with the centre top and bottom ones and then follow the cords left and right removing

each rivet as you come to it.

### **Rule 1: - Pegging Out For an Even Number Of Parts.**

See Fig. B. For a flattened out Turk's Head of this type, e.g. 5 turn 6 part and note that all crossings are vertically between the top and bottom turns and in the columns immediately to the right of these.

To peg out for this one place a peg at the top for each turn, 5 pegs. Divide the number of parts by two and place the bottom pegs that number of holes down and directly below the top pegs in this case 3 holes down.

See Fig. C. Place a guide peg immediately to the right of both our top and bottom turn pegs and vertically between these two. Place guide pegs also in the intermediate holes immediately to the left of the column joining our left hand turn pegs.

If you have enclosed exactly all the crossing points of Fig. B you have pegged out correctly.

In short - Place top and bottom turn pegs vertically above/below each other and guide pegs to enclose all crossing points.

### **Rule 2: - Pegging Out For An Odd Number Of Parts**

See Fig D for a flattened out Turk's Head of this type, e.g. 5 turn 7 part and note that all crossings are either vertically below the top turns or vertically above the bottom turns.

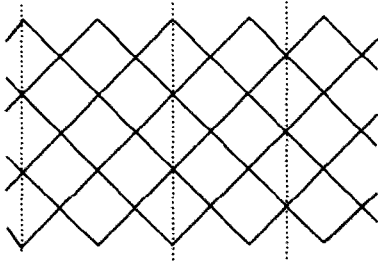

Fig. B - Even no. of parts  
6 part, 5 turn

To peg out for this one place a peg at the top for each turn, 5 pegs. Divide the number of parts by two and place the bottom pegs that number of holes down and, for the "half", a half space lower and to the right, in this case  $3\frac{1}{2}$  holes down.

See Fig. E. Place a guide peg immediately to the right of the top turn pegs and others vertically below it but not lower than the bottom turn row. Place a guide peg immediately to the left of the bottom turn pegs and others vertically above it but not higher than the top turn row.

If you have exactly enclosed all the crossing points of Fig. D, you have pegged

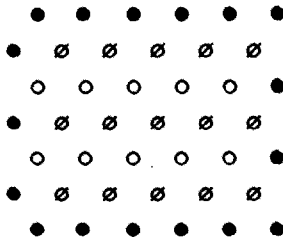

Fig. C  
As Fig. B - Pegged out

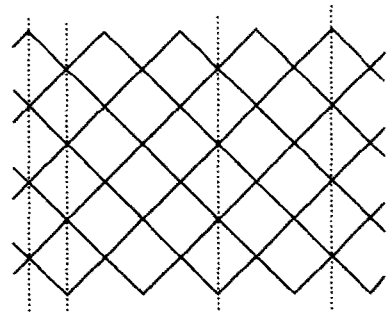

Fig. D - Odd no. of parts  
7 part, 5 turn

out correctly.

In short - Place top and bottom turn pegs being careful to offset the bottom ones a half space to the right, and guide pegs to enclose all crossing points.

The Weave: -

In the normal case we would middle the cord and take one end round a top turn peg, diagonally down to a bottom turn peg, round it and, again diagonally back up to a top turn peg, round it and so on, carefully observing all the over and under crossings. If our cord reaches back to the start we would use the other end to double up,

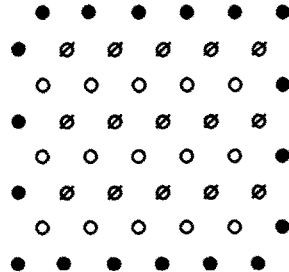

Fig. E  
As Fig. D - Pegged out



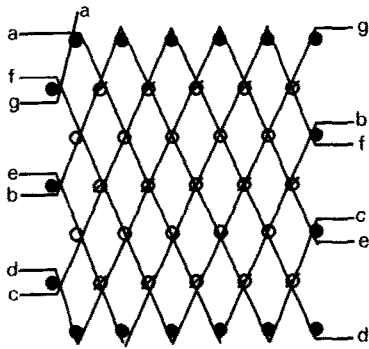

Fig. F  
As Figs. B & C - Woven

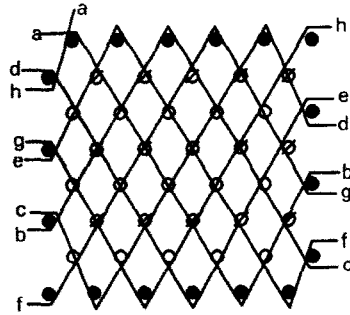

Fig. G  
As Figs. D & E - Woven

whereas if we run out of cord before reaching back to the start, we would take the unused end and weave backwards till the two ends meet. We shall do exactly the same!

To do so we must know where to come in on the left having run off to the right: -

**Rule 3: -**

Going UP (i.e. from a bottom turn towards a top turn) we go ABOVE a guide peg, round the back of the template, and BELOW the next LOWER guide peg on the opposite side and continue on up.

**Rule 4: -**

Going DOWN we go BELOW a guide peg, round the back of the template and, ABOVE the next HIGHER guide peg on the opposite side and continue on down.

And that's it folks!

Nota Bene: Be sure to only observe the crossing points WITHIN the matrix of pegs. The "Overs" and "Unders" of the guide peg holes must be ignored - they are strictly guide peg holes for cord control.

# ROPE ENDS

The first recorded instance of 'flogging round the fleet' occurred in 1698.

'A capstan bar was set up in the stern sheets of a pinnace and the wretched man, bare to the waist, had his hands lashed to the bar above his head and his feet secured to a thwart. As he came alongside each ship, the lower deck was cleared so that all men on board would witness his punishment. The cat-o'-nine-tails was made of nine lengths of cord with three knots in each. It was popularly supposed to have had nine tails because a flogging by a 'trinity of trinities' would be more sacred and more efficacious.

In 1879 the use of the cat was 'suspended' though it was never formally abolished, as it was in the Army in 1881.

*"The Guinness Book Of Ships And Shipping Facts And Feats"*

# Drawing Knots

Tony Doran

If you are like me and can't draw freehand, computer graphics are the answer for knot drawings. But - how do you get the curves nice and even - how do you keep the lines representing the cord parallel, and - how do you show the crossing points?

I use two graphics programs: 'vector graphics' *Corel Draw* to get the curves and parallel lines right and 'bitmap graphics' *Paint Shop Pro* to complete the crossings. Of course, other programs would be just as valid.

## Method

Draw the knot 'in silhouette' with vector graphics, using a thick line (say, 4mm)



Make a duplicate of the silhouette, reduce its line thickness by 25% and change to a contrasting colour.

(I usually use white, and change the colour later if I need to distinguish different cords.)



Align the original and duplicate (centre vertically and horizontally)

Export as a bitmap file (non-aliased).



Using bitmap graphics, complete the crossing points with lines of equal thickness to the black outline.

NOTE: the bitmap graphics should have the facility to draw curved (bezier) lines.

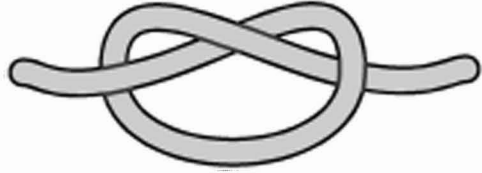

When you want to resize and file the drawing, increase to 16 million colours and switch on alias function. This reduces that jagged look.



# Allaboutknots.com

- an invitation to visit my website

allaboutknots.com is a new website on knots and knot study:

- \* Physical knots and physical knot theory
- \* Mathematical knot theory
- \* Ideal knot theory

In this website, you can

- \* Read my knot biography and write yours.
- \* Answer the Featured Question of the Month; ask your own questions.
- \* Read online my brief notes and works in progress about knots.

\* Read abstracts of my articles about knot study and order ones that interest you.

\* Consult a list of my favourite books about knots.

\* Read about my forthcoming book, Practical Knots for the 21st Century.

My new website was published May 8, 2000. You are invited to explore it, to notify friends of it, and to send me messages about it.

Dick Chisholm  
57 Mill Road  
Rumney, New Hampshire 03266  
U.S.A.  
Dick@allaboutknots.com

# Branch Lines

## East Anglian Branch

Once again 16 enthusiastic members gathered at the Museum of East Anglian Life at Stowmarket Suffolk on a fine Saturday afternoon the 30th, September, 2000. We were evenly matched with eight ladies and men.

Our stalwart of the Guild Des Pawson presented the topic of unusual but common interest about mankind's relationship with shoes and knots. He produced a large model shoe outline in wood decorated with eyelet holes and a lace/cord to demonstrate the knot tying methods, (size approx 1 metre x 30cms). He spoke of the 'Turquoise Turtle' a shoemaker's knot, (a reef bow then a single bight and one end turned through on top). Our colourful member Tuffy Turner also referred to this method and his grandfather being a shoemaker. Members generally discussed their individual preferences, then Tuffy told us that the metal or plastic ends of shoelaces were called 'Aglets' which in French means 'Small Needle'.

Dianne Bright produced a leaflet about a single handed method of threading the laces and securing with a slipped half hitch for disabled and stroke victims backed up by Ken Higgs with the reverse method and references to K.Ms. 14.p11, 42.p9 & 52.ps 25-28 on shoe lacing knots. Alison Swinscoe & Irene Turner introduced the one sided half bow for short laces and assisted Des in demonstrating his large

model shoe. Good old Tuffy came in again with his Butterfly Bow of four bights. Then we discussed the merits of the two common methods of lacing i.e. the horizontal ladder stepped method and the criss cross herring bone method. I pointed out that the medical and first aid authorities preferred the horizontal ladder method because it affords easier cutting through in the event of a foot injury.

Des produced a pair of canvas shoes made by a Dutch sailmaker used for harvesting bulbs. Most members made some input into the discussion and the interest in the subject never waned for a minute. Des also showed us a pair of shoes made from one inch strips of banding and Europa Dawson expressed an interest in creating a workshop next meeting Saturday 31st March 2001 at the same venue all being well. So next meetings topic will be to continue with the Knots and Shoes and if we have time we might try a 'Tassel' making workshop so please bring some materials along. She asked that interested members provide/bring 20 - 30 4"/10cm wide strips of newspaper folded lengthwise, edges into the middle and then doubled the same to attain an approximate width of 1 1/25mm banding; together with some clothes pegs for 'clamps'.

Ettrick Thompson is ill in hospital and we extend our good wishes to him for a speedy recovery as we do to Des Pawson following his recent operation. Our thanks are likewise extended to Barbara Watson who has offered to run our canteen for us.

Finally I offered a short mini workshop and kits to make small key fob light pull three stranded/legged x two ply

manrope knot balls with eye/beckets. A future topic workshop will be 'Net Making' and trying to achieve making a hammock. So if someone could dream up a Jig/rig we could all have a hands on experience at actual Net Knotting.

Would all members of Norfolk, Suffolk & Essex please be advised that if they do not attend three consecutive branch meetings I will be obliged to cease mailing branch meeting reminders to them because the branch costs are funded by attending members only. Any new members not listed in the current membership handbook should contact me to be included in the branch mailing list if they would like to attend local workshops. Friends and guests are always welcome.

*John Halifax*

## **Pacific Americas Branch**

We celebrated our 4th Annual General Meeting this past June. We had members from as far away as Alaska and South Carolina come to join the fun. Ken Yalden and Brian Field were also kind enough to come help us make the most of the of the time. After some business affairs on Friday night, Brian helped round out the evening with a wonderful speech on the history of knotting.

We spent Saturday and Sunday on the front lawn of the Los Angeles Maritime Museum. A number of awnings and tables were set up for the knotters for their displays and demonstrations. Dan Callahan always had a crowd around him

the whole weekend. Tillie Easton and Yvonne Chang did a teaching of the techniques Chinese Knotting. Dick Hodges showed off his knotted chess set and Joe Soanes exposed the mysteries of wire rope splicing. Everyone who attended had something to offer. A good time was definitely had by all.

The Branch also did an exhibition at Dana Point Harbor, California during their Tall Ships Festival. This is an annual event and we had participated in it for the last few years. Lindsey Philpott set up his Six-Knot Challenge and we had some real contenders this time. The string would blur as they tried to beat each other's time. Tom Mortell would wow the kids with the Zeppelin Bend and Joe Schmidbauer sold Monkey's Fist key rings.

*Joe Schmidbauer*  
**IGKT-PAB**

## **ROPE ENDS**

Nipper: in large warships on which the anchor cable was too thick to be wound round the capstan it was hauled in by binding it to an endless rope which ran round the capstan and two blocks set forward. The short lengths of rope used for this were called nippers, as were the younger members of the crew who performed the task; hence the expression 'a smart nipper'.

# Postbag

The views expressed in reader's letters do not necessarily reflect those of the Council. The Editor reserves the right to shorten any letter as necessary.

## Suggestions, please!

The IGKT Council has kindly asked me to revise, update and rewrite the booklet *Much Ado About Knotting*, to convert it into an account of the Guild's first 20 years (1982-2002). Publication will follow the 2K2 AGM. If anyone who read the first edition feels strongly that certain IGKT landmarks, anecdotes or characters were unfairly or inaccurately included, portrayed or omitted, do let me know so that I may amend the record. Similarly, please tell me those personalities, events and developments you consider ought now to be added as representative of the Guild's second decade.

*Geoffrey Budworth  
Kent, U.K.*

## Knot Noticed

I have been a member of the IGKT since 1992 and enjoy every copy of the newsletter. I am an old ropey person, not a knot person. I have looked in awe at some of the work by other members, especially the *Texel Anchor*. I have marvelled at members who tie knots by mathematics.

I have wondered how people can write books on all types of knots, when I have a battle writing this letter.

So my question to all these folk is why all these talented people have missed the knot error on our newsletter cover. Look and you will see it. I noticed it quite a few years ago and have been waiting for someone else to pick it up. Even my cousins across the Tasman missed it. What's up fellas, shearing time again?

*R. F. Hammond  
Queensland, Australia*

*(I have looked very closely at this illustration, and cannot find this mistake. Can any other of our members? Perhaps Rus, you might like to supply the answer - Ed.)*

## Pythagorean Knot

In reply to Perceval Patrick's letter in KM 68, this may represent the day of the world. In which case the corner circles or squares are the four elements, four corners of heaven, four evangelists or the four rivers of paradise. The corner shapes sometimes have crosses.

*Anne Dyer  
Shropshire, UK*

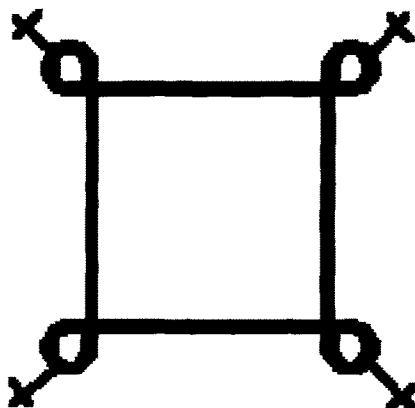

## Knotty Questions

In KM#68 (KM68 p46), a Letter by Rudi Petschek (USA) asserts that Marion's Knot is the same as a "Mooring Hitch" shown in Budworth's "Hamlyn/Complete Book of Knots", p46. Really, it is quite different and inferior (and a hitch, not a loop!); but I see how this person could be misled. If one ties Marion's with the structure LOOSE and draws it up so that the standing part STRAIGHTENS, then one gets a similar-to-GB-p.46 knot (but still not the same, and even worse, maybe)!

*Dan Lehman  
Virginia, USA*

## Disc Covering

As an artist I have for some time used knots as decorative elements in some of my art works. Not necessarily elaborate or complex knotting, but hopefully an elegant union of form and function in assembling things like kites and mobiles.

Recently I've been looking for a solution to a problem, which perhaps one of you experts can help me with. I have an object, which I want to cover decoratively with 3/32" leather strip. The object is a small top, which is constructed as follows:

An octagonal disk 2 1/2" from tip to tip, 2 11/32" from face to face.

Thickness at the centre is 11/16", curving gently to the eight faces at the edge, which measure 3/8" x 1" each. Through the centre is a 1/4" thick spindle, which is 4"

long.

What I am trying to do is find a partial covering for the disk, not necessarily terribly complicated, but something which can act as a nice decorative element and as protection for the projecting corners of the faces of the disk.

I have all the books in the world- Ashley, Bruce Grant's "Rawhide and Leather Braiding" and others, but can't come up with anything appropriate as is or which I have enough experience to adapt. Does anyone have a suggestion? My email address is [prasframing@uswest.net](mailto:prasframing@uswest.net)

*Steve Lincoln  
Colorado, USA*

## Rope Ends

Concerning page 14 "Rope Ends", in KM 66, Bob's "Between the devil and the deep blue sea" has undergone an urban transition - the generally accepted definition is to caulk a plank that difficult to get at and is applied to both a seam in the upper deck planking next to the ship's waterways and also the garboard seam which is down by the keel. The term "devil to pay" also refers to difficult places to caulk. But then we are knot-tyers rather than shipwrights.

For the record my interest is fancywork in natural fibre and maritime heritage.

*Terry Ridings  
British Columbia, Canada*

## Sengalese Shroud Knot

In issue 68, Jan Fredrik Midtflaa published the drawing of a knot that was taught to him by a seaman on the Express Coastal Steamer. He says that it was used as a trowingline, (did he mean towline?) and he would like some information about the knot.

I came across this knot in the attic/office of a friend of mine François Renault, he'd just returned from Mauritania on the north-east coast of Africa with a model of a traditional Senegal boat. The knots used on the model for the shrouds of the mast are the same as Jan's. My friend François asked for the knot's name in French... as I didn't even know it in English there wasn't much chance of that! On the photo of the boat, one can see quite clearly the knots tied onto the inboard side of the gunnel. I suppose that the shrouds are let go on the lee-side of the sail when the wind is aft of the beam, a quick-release knot would be

useful in such a situation. Also, the rigging of these boats is relatively heavy due to the very long sprit, this adds a certain instability which may require rapid dymasting to avoid or rectify a capsizing.

As for the name, I call it the Sengalese Shroud Knot or le Noeud d'Hauban Sénégalais is there any more?

*Graham macLachlan  
Ancteville, France*

## “Who are the Guild members?”

I really am interested in knots (I have published articles on the Corkscrew knot, KM 62 & 64; and on the Marion knot, KM 68; two releasable hitches), so I do want to have a job that has got something to do with knots!

When I was a kid I wanted to be a mountain guide, but I have been told: “IMPOSSIBLE!”.

Later I have tried to specialise, becoming a climbing teacher, but once again: “NO!”.

Recently I passed an exam to enter the unique French school for acrobatic works. They did not accept me this time because of my wide knowledge on knots and ropes techniques: they prefer to form fully ignorant people with THEIR method. That's the limit!

So now I do not really know in which way to orientate my life, but how many of us (I mean Guild members) are really earning their life thanks to knots? And in





which job? I think it would be interesting to know which members are seamen, sailors, firemen, mountaineers, farmers, scouts, and anglers?

I suggest that the members who want to reply send me a postcard (I would be pleased to carry out this study) telling me:

- If they have a job with knots? If so, which one?
- If knots for them are a passion, pastime or an occupation, and which ones?
- Or if their passion for knots is really disinterested?

At the same time members could tell me for instance the five knots they prefer to use, to make a list of the most appreciated knots (depending on their activity).

After three months (for the following KM) I will write an article to give the results of this study.

I promise:

- To try to answer each person by a postcard of my village (if you give me your address)
- There will be no commercial distribution done with these results (publicity...)

This “mini” study would allow the IGKT to know what the motivations of its members are, what the present knotting activities are (apart from sea-world of course), etc.

Now at least I know I want to look for a fulfilling job and to travel at the same time. In a word, if any of you has any interesting job (with knots if possible!) anywhere in the world, just tell me and I WILL COME! I am always interested in

learning more on knots.

You can use my e-mail (mannet@free.fr), or my postal address. I prefer postcards for the instructive photos, and also for the stamps which will be preciously retained!

*Olivier Peron  
Ansois, France*

### **About the “One for Old Salts”**

“How many ropes are there on a full rigged ship?”

Answer: only one...the bellrope!!...(They are called Lines on board ship...ropes on shore)

“What were once the seven seas?”

Answer: Arctic, Antarctic, North Atlantic, South Atlantic,

North Pacific, South Pacific, and Indian Oceans...but I’ve got a feeling this is a trick question too...{I have 7 anchors on my websites for the “seven seas”}....

*Dan Callahan  
Alaska, USA*

*Answers to “One for Old Salts”, supplied by Reg White*

Q. How many ropes are there on a full rigged ship?

A. Five the names being Bell; Bolt; Bucket; Main and Foot.

Q. What were once the seven seas?

A. Arctic; Antarctic; North Pacific; South Pacific; North Atlantic; South Atlantic; Indian Ocean

# Knotting Diary

Tel: 078 614 6002  
E-mail: jchoefna@cybercomm.nl

## AGM's & 1/2 YEARLY MEETINGS

### IGKT 19th Annual General Meeting

Farnham, Hampshire  
12th May 2001  
Contact: Nigel Harding

### IGKT Half-yearly Meeting

Ellesmere Port, Cheshire  
13th October 2001  
Contact: David Walker  
Tel: 01244 682117  
E-mail: getknotted@appleonline.net

## BRANCH MEETINGS

Swedish Branch  
10th March 2001,  
Visit to Alvängen Rope Yard,  
north of Gotenburg  
Contact: Olof Nystrom  
Tel: 08 265 065  
E-mail: olof.nystrom@nybnd.com

East Anglian Branch  
31st March 2001  
Museum of East Anglian Life,  
Stowmarket, Suffolk  
Contact: John Halifax  
Tel: 01502 519123

## CLASSES

Knotwork - Rotterdam  
Monday, Wednesday and last Saturday of  
month.  
1000 - 1700 on the boat "Hope"  
Rotterdam Maritime Museum  
Contact: Jan Hoefnagel

### SECRETARY:

Nigel Harding  
16 Egles Grove,  
Uckfield,  
Sussex, TH22 2BY  
Tel: 01825 760425  
E-mail: nigel@nigelharding.demon.co.uk

### Guild Annual Subscription rates:

Juniors £5  
Seniors £16  
Families £20  
Corporate by arrangement  
Payable by cash/cheque Eurocard, Mastercard  
or Visa. Taxpayers in UK - we would prefer a  
covenanted subscription.

### EDITOR:

Colin Grundy  
4 Hanwood Close,  
Eastern Green,  
Coventry CV5 7DZ  
Tel: 024 7646 8603  
E-mail: colingrundy@lineone.net

### Advertising Rates:

	Members	Non-members
Full page	£32	£49
Half page	£19	£22
Quarter Page	£10	£15

# Guild Supplies

## Price List 2000

<b>Item</b>	<b>Price</b>
<b>Geoffrey Budworth</b>	
Knotlore <i>a miscellany of quotes from fact and fiction</i>	£2.50
Much Ado About Knotting <i>history of the 1<sup>st</sup> 10 years of the Guild</i>	£2.50 *
The Knot Book	£3.99
<b>Brian Field</b>	
Breastplate Designs	£2.50
Concerning Crosses	£1.50
<b>Eric Franklin</b>	
Turkesheads the Traditional Way	£1.50 *
Nylon Novelties	£2.00 *
<b>Stuart Grainger</b>	
Knotcraft	£3.60 *
Ropefolk	£1.30
Turks Head Alternatives	£2.20 *
Creative Ropecraft	£9.95
Knotted Fabrics	£9.00
	<i>Hardback price includes UK postage</i>
<b>John Halifax</b>	
Something Different <i>with over 50 Button Knots</i>	£3.20 *
<b>Harold Scott</b>	
On Various Cruxiform Turks Heads	£2.50
Sliding Template Method for Designing Cruciform Turks-Heads Vol. 2	£3.00
<b>IGKT</b>	
Knotting Matters <i>copies of past editions</i>	£2.50
<i>(Some past editions available – contact the Secretary for details)</i>	
* bulk purchases of these items available at a discount – phone for details	

Cheques payable to IGKT, or simply send your credit card details  
**PS** Dont forget to allow for Postage

**Supplies Secretary:- Bruce Turley**  
**19 Windmill Avenue, Rubery, Birmingham B45 9SP**  
**email 106077.1156@compuserv.com**  
**Telephone: 0121 453 4124**

