

Knotting Matters

The Magazine of the International Guild of Knot Tyers



Issue 81
December 2003



Guild Supplies

Price List 2003

Item	Price
Knot Charts	
Full Set of 100 charts	£10.00
Individual charts	£0.20
Rubber Stamp	
IGKT Member, with logo (excludes stamp pad)	£4.00
Guild Tie	
Long, dark blue with Guild Logo in gold	£8.95
Badges - all with Guild Logo	
Blazer Badge	£1.00
Enamel Brooch	£2.00
Windscreen Sticker	£1.00
Certificate of Membership	£2.50
Parchment membership scroll Signed by the President and Hon Sec For mounting and hanging	

Cheques payable to IGKT, or simply send your credit card details

PS Don't forget to allow for postage

Supplies Secretary: - Bruce Turley
19 Windmill Avenue, Rubery, Birmingham B45 9SP
email bruce.turley@blueyonder.co.uk
Telephone: 0121 453 4124

Knotting Matters

**Magazine of the
International Guild of
Knot Tyers**

Issue No. 81

**President: Jeff Wyatt
Secretary: Nigel Harding
Editor: Colin Grundy
Website: www.igkt.net**

**Submission dates for articles
KM 82 07 JAN 2004
KM 83 07 APR 2004**

The IGKT is a UK Registered
Charity No. 802153

Except as otherwise indicated, copyright
in Knotting Matters is reserved to the In-
ternational Guild of Knot Tyers IGKT
2003. Copyright of members articles
published in Knotting Matters is reserved
to the authors and permission to reprint
should be sought from the author and ed-
itor. All sources of quotations printed in
Knotting Matters are acknowledged.
ISSN 0959-2881



*Ben Self demonstrates the art of fender making at the Inland waterways Festival.
Back Cover: Rigging on the bowsprit of
SS Great Britain, Bristol, UK.*

IN THIS ISSUE

Secretary's Blotter	2
President's Letter	3
IGKT Website	5
Alpine Butterfly Loop	6
WoW - Wild on Waterways	10
Book Reviews	13
Knotmaster	14
How a guitar string became a Heaving-line	16
Net Making	18
Knot Gallery	22
The IGKT Logo Mathematically	
Speaking	28
Webbing Knots - Part 4	34
An Alternative Notation for Knot Diagrams	38
Branch Lines	40
Postbag	42

Notes from the Secretary's Blotter

As I am writing these *Notes from the Secretary's Blotter*, autumn has finally arrived after what must have been the longest and hottest summer for almost 20 years. Driving to work through Ashdown Forest, one of the last ancient forests of England, the colours of the trees have been outstanding. I have even seen deer roaming at the edge of the road. By the time this has fallen on your doormat, it will be Christmas, and this gives me the ideal opportunity to send you the seasons greetings, and hope that all goes well for you in the New Year.

The New Year will also bring with it the increase in subscriptions, which was approved by the members present at the AGM last May, in accordance with the Constitution. Just as a reminder, from the 1st January 2004, the Adult subscription has risen from £16 to £18, and the Family subscription has gone up a similar amount to £22. This is the first increase for several years, and the Council hopes that this will not change again soon.

Whilst on the subject of subscriptions, there seems to have been a little confusion caused when some members received reminders from the Charities Aid Foundation. Due to the way in which we set up member's account with CAF, their record of renewal dates is different from mine. This should not have caused a problem, however I had overlooked the fact that they provided a 'reminder service', in addition to the reminders that I send out. The net result has been a good deal of confusion, and I can only apologise for this. However, I can

confirm that I have asked CAF not to send any more reminders out until further notice.

I must also remind members that at present the CAF can only accept members fees in UK pounds, which of course includes credit card payments. If you have a problem with this, it is possible for me to accept payment in US dollars, but do please send them to me, and not CAF. Those who pay by Standing Order should by now have cancelled it, and returned the new Direct Debit form to the CAF, or myself. This is all just to make life easier for those of us who are administering the Guild on your behalf.

Finally, moving away from the boring subject of finance, I must give you advance notice of the next AGM, which is to be held at the Historic Dockyard in Chatham, which is in the South East of England. The meeting will be held on the 8th May 2004, and should be an amazing event, as this dockyard has been home to the British Navy for hundreds of years, until it was closed just a few years ago. The original ropewalk is still in commission, and producing ropes in both modern and traditional materials, and will be open for viewing. I have convinced the museum authorities that our meetings are something to behold, and they are hoping to publicise our event in their official programme for next year. This promises to be excellent meeting with a wonderful opportunity to meet the public, and I look forward to seeing you all there

Nigel Harding

President's Letter

I start this edition of the *President's Letter* on a sad note. I would like to send sincere condolences on behalf of the Guild, to Kay Lewis, whose husband, Wayne, was a staunch member of the Texas Branch, and who died suddenly, although not unexpectedly, in June. He had been looking forward to attending the North American Branch AGM in October, but as Kay says, "he will be there in spirit".

On a somewhat lighter note, I was invited to give a talk at the 'Skill-Swapping Weekend' organised by the Braid Society. The aim of my talk was to demonstrate knotting techniques relevant to braid makers. I'm sure I learnt more than I taught! The IGKT can gain a lot from these types of weekends, and it gives food for thought, not only at home, but also overseas, as to what can be achieved by weekends dedicated to 'skill-swapping'.

It was good to meet members of another Society, including one from our own, Edna Gibson from Devon who was also giving a talk, on "Findings and Finishings". The hospitality was excellent and I had a thoroughly enjoyable weekend, and to prove how good a time I had, I have since become a member of the Braiding Society.

I'm glad to hear that Tony Fisher and his wife, Carolyn, whose teaching contract has been extended, will be honouring us with their presence for another year! Unfortunately he decided that because of his extended stay he could no longer remain President of the

New Zealand Chapter. New Zealand's loss is our gain!

My wife, Lesley, and I went on our annual pilgrimage to Butser, in Hampshire, invited by the Solent Branch to help man their stand at the Queen Elizabeth Country Park Show. The weather was glorious and, boy, did they work me hard. Members of the Solent Branch do turn out some beautiful work, and they put together a first-class exhibition of knotting skills.

We have also attended a couple of local IWA Canal Festivals, one at Wendover and the other at Leighton Buzzard, and visited the Braunston Narrowboat Festival where Ken Nelson and Colin Grundy were doing sterling work in promoting the Guild.

The next big event on our calendar is the North American Branch AGM at Newport News, Virginia, in October. Several members of the Guild in England will be in attendance, including Lesley and myself. Unfortunately this was arranged before we knew that the date for the Guild's Half-Yearly Meeting in Ipswich had been changed and was now being held at the same time. I apologise for not being able to attend the Ipswich meeting, especially as it will be only the 2nd meeting I have missed since joining the Guild.

The Travel Scholarship discussed at the AGM, has finally been accepted in principle, by the Committee, and will eventually go ahead, after dotting all the i's and crossing all the t's.

Jeff Wyatt

Col's Comment

What a busy year this has been, with shows, meetings and editing KM, the time has fairly flown by.

Some of our readers had spotted in the last issue of *Knotting Matters*, a notice asking for copy to be posted to Nigel Harding. This is a temporary measure, as I expect to be moving house in the near future, and it will allow some form of continuity. As soon as things have settled down again, I will inform you of my new address.

Finally, may I wish you all a good Christmas and happy New Year.

Frank Harris

Many of our members will remember Frank Harris. This letter was received recently from his daughter.

“My father Frank Harris, wishes me to inform you that he has moved to Kent to be nearer his daughters, his new address is Room 36, Woodgate, Tudely Lane, Tonbridge, Kent TN11 0QJ. Tel 01732 350952.

My father appears to have settled into his new surroundings and is enjoying the company of the other residents, at nearly 90 he has done well to live alone for so long, but now feels the need to be nearer to us and to have all the benefits that are offered from his new residence. He is well in himself, although a little frail and forgetful, but would like to be remembered to all members of the Guild to whom he sends his fondest wishes.

Any correspondence should be sent to his new address, where visitors are most welcome. These days he does not cope well by telephone, but would be happy to correspond by post.”

Obituary

I am sorry to report that one of our early members; Tom Long of Kings Lynn, slipped his anchor on the 20th of July 2003 at the age of 86. He was featured in “Profile of a Knotsman” in *Knotting Matters* #12. A fine Knot Tyer, making large and intricate knot boards, he would travel down to our early meetings from Kings Lynn. As the years got the better of him and he could not travel so easily, he put his knot tying energies into supporting True’s Yard, the museum of fishing and maritime life, in Kings Lynn. I wonder how many thousands of his green and yellow [these being the colours of the local Norwich City football team] key fobs they sold.

There was another side to Tom. During the second world war he was Chief Petty Officer on the renowned French fishing vessel *MUTIN* that was fitted out as a French tunny fisher and worked out of the Helford River in Cornwall, smuggling undercover agents in and out of occupied France. For this work he was awarded the Distinguished Service Medal in 1945. It was one of his proudest moments to be guest of honour when the French Navy returned with *MUTIN* to the Helford River in 1997.

He will be greatly missed by many people; our condolences go to his wife and family.

Des Pawson

IGKT Website

After the initial burst of activity to get the Guild's website up and running again, all has gone very quiet. There have only been one or two recent additions to the Galleries, and a few links to other sites added. The Forum is still active but I think non-members are a little disappointed that their questions are going unanswered. So if any web-wise members could regularly log on to the Forum and correspond with these people, it might even generate a few more members!!! There are some very interesting items being posted there, and it looks as if some comments by contributors about the lack of response has had some effect. But, as our Web Mistress says "A good web forum needs nurturing. It doesn't take care of itself."

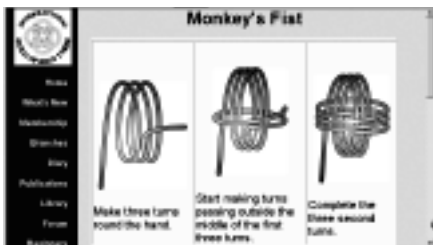

One thing that did happen this summer was the fact that we had to close down the Guestbook. There were far too many "inappropriate" comments being left, including links to pornographic sites etc, so our Webmistress and I had to come to the sad decision that the only way to combat this was to remove the facility. Luckily this does not appear to have crept over to the Forum. There have

been a few additions to the Forum section, for Feedback, Polls and Announcements.

Since we now have the opportunity to list links to almost any knotting site, it might be an idea to issue an invitation (via *Knotting Matters*?) to people to send in their favourite knotting links. The more links we can have, the better the site's positioning in search engine results!! Of course, if any members have their own website, we can put a link to their site in the Links section. Ideally, we'd like to know where the site is, its name and one or two lines that describe what the site is about.

The Galleries are always open to Guild members, so if you are 'on-line' just email your pictures to me, or send your photographs to me at: 91 Luton Road, Dunstable, Beds LU5 4LW, England. I can scan them and forward them to our illustrious Webmistress, but the pictures do need to be as sharp as possible.

Lesley Wyatt
Web Administrator

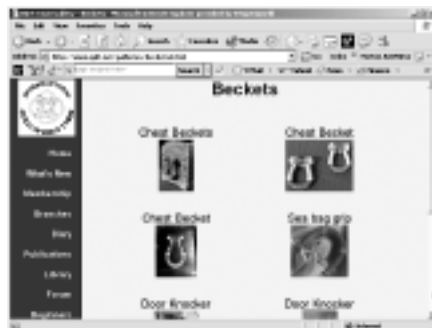

Alpine Butterfly Loop 'The Queen of Knots'

by Cy Canute

Skimming through *The Complete Guide to Rope Techniques*, an instruction manual for mountaineers by Nigel Shepherd, published by Constable (London, 2001), I found his opinion of the Alpine Butterfly Loop;

'This knot is used for tying into the middle of the rope. It is by far the most suitable knot ... it could be said that the knot was designed for the purpose.'

Well, yes, it may have been. Although I had assumed that few of today's climbers knew or used it. Indeed that could be the situation because Mr. Shepherd adds;

'Although not in common usage, this knot is gaining credence and popularity. I suspect one of the reasons it has been so ignored over the years is that it is quite complicated to tie.'

Oh, come on! It isn't quantum physics or learning to ride a unicycle. As rope-work author John Sweet observed;

'... it is so easy to make that one can only wonder why it is not in more general use.'

That was in *Scout Pioneering*, published (London, 1974) by The Scout Association, where he also nominated the Alpine Butterfly loop for the sobriquet 'Queen of Knots', inspired by the novelist, poet, lyricist and wit A.P.

Herbert's earlier declaration that 'The Bowline is the King of Knots'.

There is a snag, however, with any so-called middle-man's tie-on around the waist. The climber thus tethered can sometimes be tugged this way and that, like seaweed in an surging tide, by stray moves of his or her companions. A modicum of slack can be had by clipping a harness-held karabiner into a small Alpine Butterfly loop; and even more freedom won, without sacrificing safety, if the loop is longer (but no more than an arm's length) and tied in a figure-of-eight knot close to the attachment of the karabiner. This was impossible, of course, before karabiners came into regular use around the 1930s.

Some knotting pundits suggest that this knot with the pretty name is derived from the artilleryman's or man-harness (1870: man's harness) knot, hitch or loop. Then again, Harry Asher wrote in *The Alternative Knot Book* (London, 1989);

'This [the Alpine Butterfly] knot has been used by mountaineers ... since ancient times.'

Without evidence to support that contention, however, it remains a 20th century phenomenon. The loop-on-loop method of tying it that he portrays (fig. 1 in this essay of mine) was retrieved by Guild member Lester Copesteak from a 1928 issue of *The Alpine Journal*.

In their American publication *Encyclopedia of Knots and Fancy Rope Work* (Maryland, 1939), Graumont &

Hensel illustrate the knot but refer to it as a Lineman's Loop (plate 21, fig. 6).

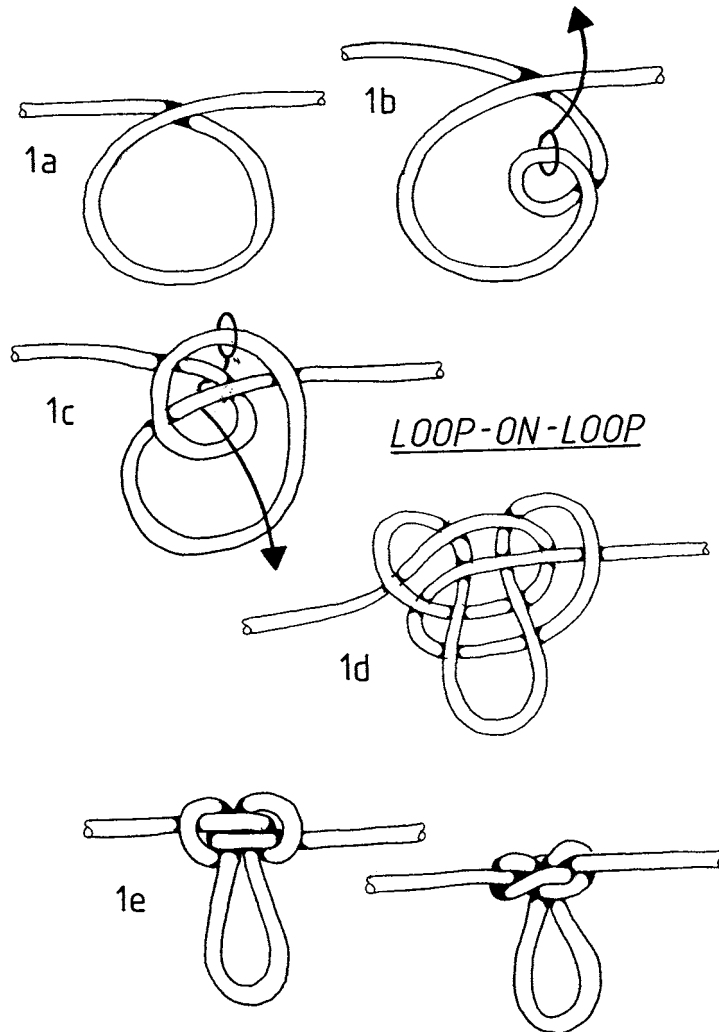

Clifford Ashley in *The Ashley Book of Knots* (New York, 1944) also labels it Lineman's Loop (#1053) but portrays the twister method (see my fig. 2). Apparently unaware of its European doppelganger, he credits fellow

American James M. Drew with first publishing and naming the knot, in - I guess - *Ropework, Knots, Hitches, Splices, Halters* (St. Paul, 1936).

The most up-to-date leapfrog method (fig. 3) for this tied-in-the-bight loop

knot appeared in *Knots* by Brion Toss (New York, 1990).

If you can back-date the Alpine Butterfly Loop before 1928, do tell the editor of *Knotting Matters*. Until then, I

am just glad to see it rediscovered and re-adopted, for as Brion Toss remarked in *The Rigger's Locker* (1992);

'... old knots never die; they just wait for us to come to our senses.'

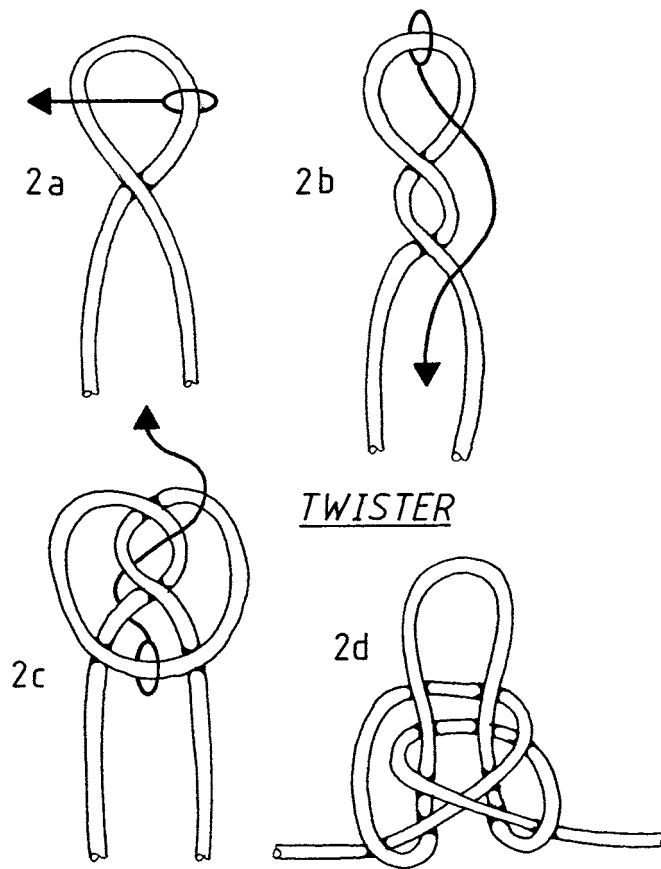

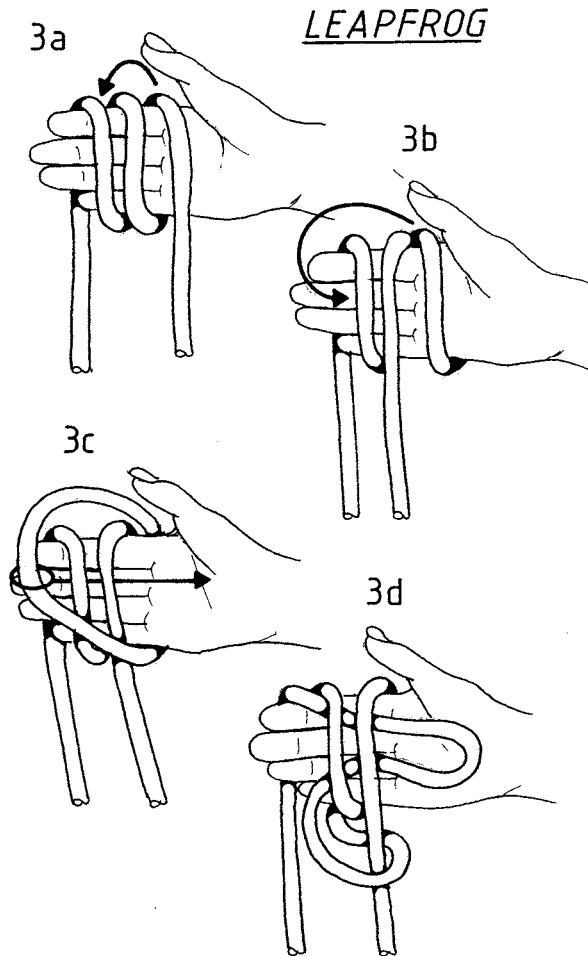

“Every man aboard knows the penalty. Fifty licks of the cat.” He watched their faces. Fifty strokes of the knotted leather thongs could cripple a man for life. A hundred strokes was a sentence of certain and horrible death. “They have earned themselves the full fifty. However, I remember that these four fools fought well on this very deck when we captured this vessel.”

“I am a merciful man.” he told them. “Make it fifteen for each, Master Daniel, but comb your cat well between the strokes.”

Birds of Prey
Wilbur Smith

WoW - Wild on Waterways

by Chris Selfe

A caveman," replied the five-year-old boy solemnly when Charlie Tyrrell asked him what type of knot he should make. Charlie kneeling on the ground in front of the boy and his younger brother pondered the unusual request then tied a figure of eight into the end of the rope. He then proceeded with the new rope trick 'put the caveman in the cave'; known to you and me as thread the rope through the loop. Such inventiveness and enthusiasm on the part of all the members when children came to visit added to the popularity of the stand. The young lad was participating

in WoW, (Wild on Waterways) at the Inland Waterways Association Festival, Beale Park, during August where children went from stand to stand to try their hand at different activities. After patient tuition from Charlie the lad left with a stamped passport and a wide grin.

Ken Nelson did a marvellous job of organising the event and close to twenty guild members turned up over the four days to man the stands and demonstrate knot-tying to the public. Colin Grundy did hourly braid on braid splicing demos while Ben Selfe demonstrated the art of fender making. Ken gave two



James Sutro now convinced to join the Guild



workshops on decorative ropework. Both were well attended and on one occasion Ken had so many participants he had to recruit the assistance of Charlie Tyrrell and Nicola Chandler. The demonstrations proved to be responsible for a lot of the book sales and an anchor made by Fred Parker on Monday was a perfect example of this.

Forty-five minutes into the show a new guild member was recruited.

American James Sutro didn't think twice when offered a membership leaflet and signed on the spot. During the

festival more than seven new members could be added to the Guild's list. Ken Nelson said, "If we could pick up membership like we did this time it would be fantastic."

The star of the show as ever was Lonnie Boggs with his rope-making machine.

The energy and enthusiasm that Lonnie puts into teaching the children leaves many of us gasping for breath. He starts before the show opens and has to be told to stop when the show has closed. Poor Lonnie had hardly any time to eat or rest, as the queue of waiting children and even adults was always long. One eager youngster, Gina Wallis-Smith visited the stand every day and became Lonnie's right-hand woman, helping to teach others her new obsession. Peter Goldstone brought along his rope-making machine on Saturday, which helped relieve the workload and ensured everyone got a chance to take home a length of uniquely designed rope.

Lonnie demonstrates rope-making





The weather played its part and we were blessed with sunshine for most of the time.

On the rare occasion when things were quiet, members shared their knowledge with each other. Ken showed everyone the two-ring rope trick and we all fell about laughing watching the faces and actions of Nick Wilde, Jim Hawkins, Alex Carson and especially Ben Selfe who seemed to think the trick would work better if he let out a warrior cry at every attempt.

The IWA festival at Beale Park proved to be a roaring success thanks to the enthusiasm of the guild members (unfortunately there was not space to mention everybody here) and their willingness to demonstrate that knot-tying need not be just practical or decorative but also lots of fun.

*Left: A tall order for rope making.
Below: Ken Nelson astounds passers by with the boomerang knot.*



Book Reviews

Chinese Knots for Beaded Jewellery

by Suzen Millodot published (UK, January 2003) by Search Press Ltd. ISBN: 0-85532-968-8

Price: UK £9.99US \$19.95

Suzen Millodot is an IGKT member, currently living in Israel, and an accomplished arts and crafts practitioner.

This glossy, soft cover 80-page book, a slim 206-mm x 204-mm, is lavishly illustrated throughout in colour with over 300 photographs (amplified, where necessary, by additional line drawings) and 17 full-page plates.

The contents open with a brief history of knots in general, and Chinese knots in particular, then continue with essential early guidance in the required tools, materials and techniques. Individual knots - which include the button, clover leaf, cross, double coin, double connection, flat, good luck, pan chang, plafond, prosperity, round brocade, snake and virtue knots - are introduced, one at a time, in the form of 16 knotted projects creating original bracelets and necklaces. Lists of ingredients precede step-by-step instruction and expert tips.

Suzen's book demystifies Chinese knotting for beginners; but it will also delight those already adept at this kind of knotting, for she has artfully combined beads of wood, glass, metal and semi-precious stones with leather thongs, braided cotton and thick satin rattail. in a

virtuoso display of mix-&-match material selection and colour control. It is not just a how-to manual but also a source of artistic inspiration.

The book concludes with a useful index.

Obtain a copy from any good book shop or art & craft outlet and, if you can, visit the author's website: www.chineseknots-r-us.8k.com

For the latest information about other art and craft books available from Search Press Limited, as well as to order a free colour catalogue, or to find out where to obtain materials and equipment, visit their website: www.searchpress.com

Alternatively write to them at Search Press Ltd., Weliwood, North Farm Road, Tunbridge Wells, Kent TN2 3DR.

Tel:+44 (0)1892 510850; Fax: 01892 515903;

E-mail: sales@searchpress.com

US customers should call toll-free on (800) 289-9276, or write to Search Press USA, 1338 Ross Street, Petaluma, CA 94954

G.B.

Des Pawson's Knot Craft by Des Pawson, with illustrations by Ann Norman published (UK, October 2003) by Adlard Coles Nautical.

ISBN: 0-7136-5441-4

Price: UK £10.99

Des Pawson needs no introduction to Guild members, being one of the co-founders of the IGKT. His lifetime of working with rope and his experience and passion for the subject comes over in this book. Ann Norman, another Guild member is perhaps a little less well

known. Ann is a professional rope maker, with her own ropewalk in the Oxfordshire village of Bampton, she is also an accomplished illustrator.

Among the problems facing knot tyers when they want to create a knotted article, are how to go about it and how much material will they want? If you are looking at that beautifully crafted bell rope or fender at a Guild meeting, you may be able to ask the person who tied it. Here is a book that will answer that question for you, and many more.

In this slim 96-page book, Des passes on a host of hints and tips gained from years of studying and making knotted articles. It starts off with an introduction to his idea of keeping a recipe book of materials, lengths, knots and other hints and tips he has used over the years. He goes on to talk about tools, cordage, a few useful knots and the part I really liked, mixtures of tar and tallow etc.

The main part of the book covers some 28 projects, from a simple key ring, to chest beackets, wheel coverings and even tips on making knot boards. Each project contains information on the materials required and their lengths, and the knots used in the project. Each knot is beautifully illustrated, along with the finished article. Des continues to pass on tips of the trade in each chapter.

The final pages of the book contain details of suppliers (UK and USA only), further reading and a section on the IGKT.

This book fills a gap in the knotting library, not only for the newcomer to knot tying, but also for the more experienced. It may not fulfil all your needs, but is full of useful information that is difficult to find elsewhere.

CG

Knotmaster Series No. 19

*'Knotting ventured,
knotting gained.'*

Common whipping

Some people admit to Knotmaster that they avoid using this time-honoured whipping, uncertain how exactly it works. It is quite simple.

Lay a bight or loop of whipping twine alongside the rope and trap it within a series of snug, tight wrapping turns (fig. 1). Continue until the whipping is at least as long as the diameter of the line being seized - and a trifle more - then tuck the working end through what remains of the original bight (fig. 2). So as to make the next step easy, keep the last wrapping slacker than those preceding it. Now pull the unused end of the twine, as shown (fig. 3) so that it drags the working end beneath the whipping, creating a couple of interlocked elbows with the two ends (fig. 4). Stop pulling when these elbows are located at the centre of the whipping. Cut off the ends.

NOTE: Bind towards the cut end, and whip hawser-laid lines in the opposite direction to the lay of the strands, so that any tendency of the rope to un-lay will automatically tighten the whipping.

Common whipping

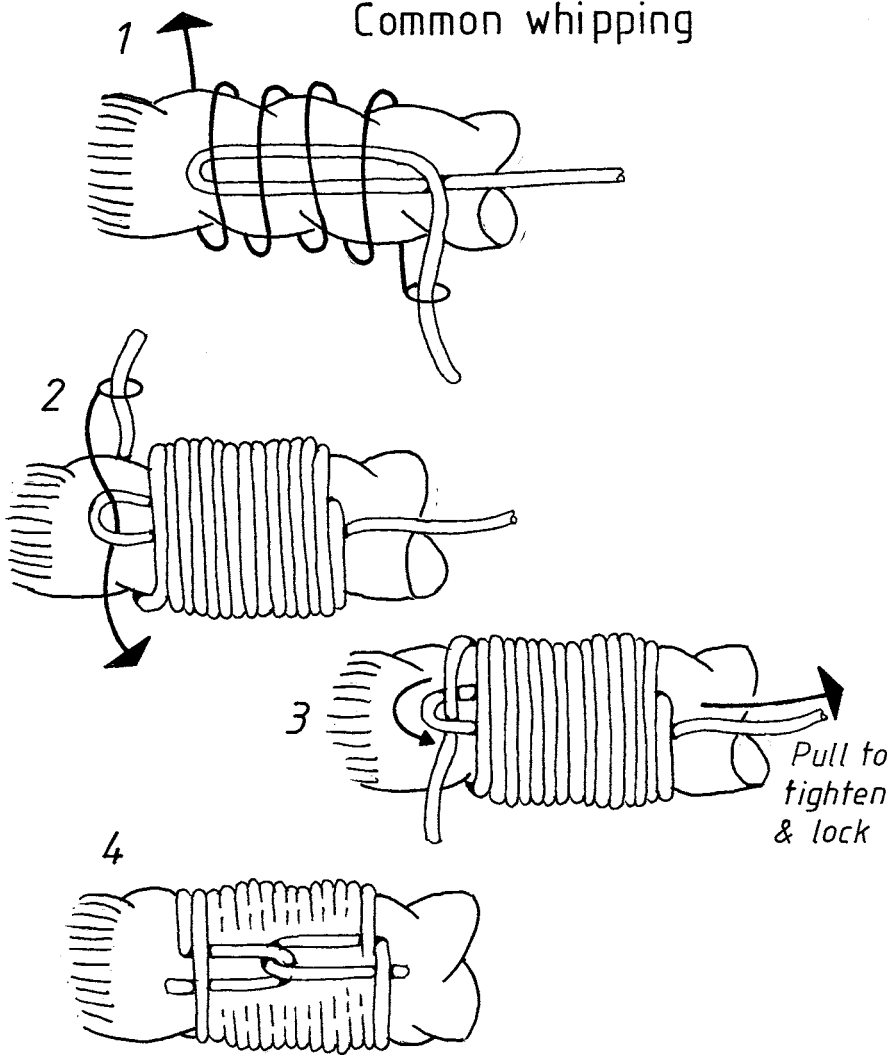

How a guitar string became a Heaving-line!

by Sten Johansson

In 1908 the Swedish professor Hjalmar Öhrwall published a book called *Om Knutar* (About Knots). A new revised edition was published in 1916. A thick book of 253 pages illustrated by his daughter, it has a dictionary in seven languages.

At pages 189-190 in the chapter *Splices, Whippings, Seizings and Belayings*, he writes (free translation from Swedish into English),

“A very ingenious ‘belaying knot’ that I found in the Museum of Gothenburg on a Japanese musical instrument ‘Samisen’ similar to a guitar, to attach the strings, is shown in Fig 224 from one side and in Fig 225 from the other side: at the lower part of the instrument is a number of fixed eyes attached, one for each string. With the string you make a round turn around the two parts in the eye, so it

comes back between its own part and the eye lets it, when it comes in the middle of the space between the eye’s two parts, crosses itself, and pass between those on the other side, across its own part, thereafter up through the eye and then towards the instrument to the turning peg and it’s neck. The string is consequently not attached to the eye itself, which it never touches, when it is tightened, but strain equal on both lines and the transverse little piece of the string is forming an edge, which the string is crossing and defines its length. This simple belaying is superb and can be used for other purposes. If it already from the beginning is tied as a slip knot it can easily be untied”.

Ashley saw this ingenious ‘belaying knot’, and apparently as he did not understand Swedish, he assumed it was a heaving-line bend (ABOK #1463) to be used on a hawser as the figures show one heavy line and one lighter bended together. As a source he wrote, “Given by Öhrwall”.

First to steal this knot from Ashley was E C Fry in *The Book of Knots and Ropework* (1977). He writes, “Used to make a heaving-line fast to a hawser.” He makes it with a slip knot “. . . can equally quickly be let go particularly if the heaving line has a monkey’s fist in the end.” No source is mentioned.

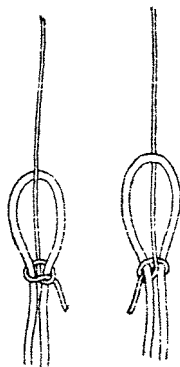

Fig. 224.

Fig. 225.

Geoffrey Budworth in his *The Ultimate Encyclopedia of Knots and Ropework* (1999) shows it in Ashley's version and writes, "It was first mentioned in a seamanship manual of 1912". What seamanship manual? It is not mentioned in Örhwall's first edition 1908 and neither in his small paperback called *The Most Important Knots* and published in 1912.

In his book *Sailing Knots* (2000) Geoffrey Budworth has changed the origin of the knot, "Hjalmar Örhwall includes this knot in *Om Knutar* 1916".

In 2000 M Constantino published her book *The Knot Handbook*, a heavy book of 250 pages and shows 'the heaving-line bend.' As the seamanship manual of 1912 she writes, "First mentioned in 1912 in a Swedish knot manual *De Viktigaste Knutarna* by Hjalmar Örhwall." As mentioned above, this book *The Most Important Knots* does not show this knot. However, already in 1914 the Swedish master mariner Sam Svensson in his

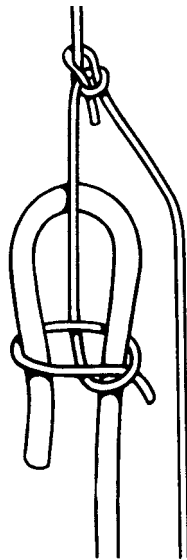

Fig. 98 Heaving line bend

book *Handbok i Sjomansarbete* (published in English in 1971 as *Handbook of Seaman's Ropework*) had noticed this ingenious knot and calls it a 'heaving-line bend' and finds it useful when ropes differ greatly in size. He writes, that it is suitable, not only for taking a mooring rope ashore, but also for sending up a gantline with a flag halyard.

That is how a guitar string became a heaving-line.

The Reef Knot

The reef knot's fine for little tasks
Like tying tags on sails
But a sailor never asks
For this one on rails.

The reef knot is a brief knot
Which unmended makes a grief knot;

A grief knot is a thief knot
Which untended takes a leaf knot;

As the leaf not on a tree
Has not a long life -
So the reef knot running free
May cause a lot of strife!

Michael Jenaid
Knots & Their Vices, 1969

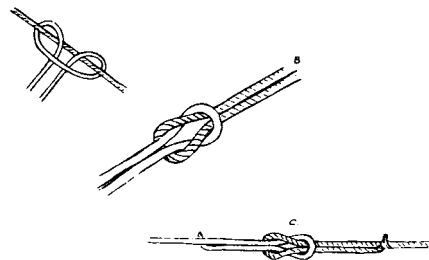

Net Making

by Tony Emery

Net making is a traditional handcraft of Pennsylvania. The method and patterns shown here are those used by the family of Mr Daniel Moser of Pennsburg, Pa. In the early 1900's Mr Moser and his family made fish traps and nets for commercial fishermen of Chesapeake Bay and the lower Susquehanna River. Mr Moser was taught by his grandmother and passed his knowledge on to me.

In net making, a series of loops are tied using a simple knot. The gauge keeps the loops uniform in size and a needle or shuttle holds the twine. These tools can be made from any flat sturdy material (ruler, paint stirring stick, masonite, tongue depressor, heavy cardboard, etc.). The simple needle has a notch cut at both ends and is loaded end over end. It is worth the trouble to make the more difficult traditional needle. The

pointed end makes the netting easier and the spine prevents the twine from unwinding until you need it.

Use cotton mason (seine) twine, available from any hardware store. An anchor is made from a 2' length of twine with its ends tied together to form a loop. The anchor is placed over a stationary object (C-clamp, hook, doorknob, chair back etc.). The first row of loops is cast onto the anchor, which also helps to keep the work taught.

Load your needle and bring it back from behind through the anchor, leaving a 6" tail. Pinch the two strands (legs) together 1" below the anchor with the thumb and forefinger of your left hand. At the same time pull back with your left hand to keep the work taught. The right hand now guides the needle to lock the two legs together with a half-hitch knot.

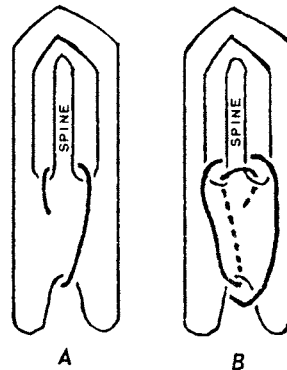
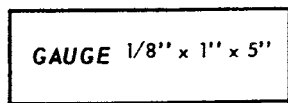
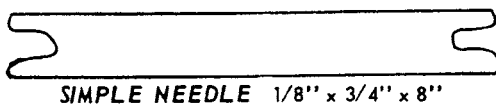

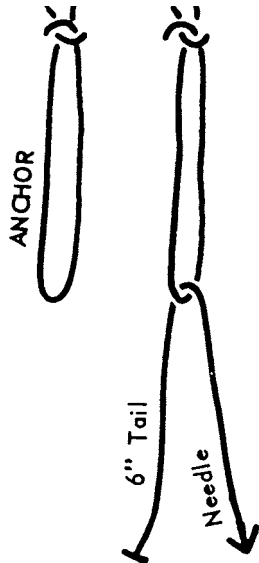

- A. Make a keyhole arc to the left of the two legs.
- B. Bring the needle behind the two legs and through the keyhole.
- C. Draw the knot tight and release the pinch.

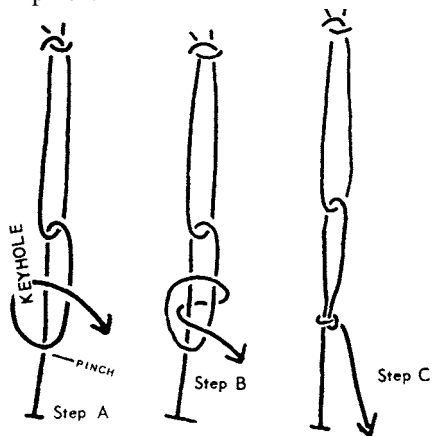

The same knot is now tied using the gauge to make uniform loops. The gauge is held in the left hand with the top edge directly below and touching the first knot. The right hand guides the needle

down around the gauge, up through the anchor, and down to the gauge, forming two legs. Pinch the legs against the top of the gauge, make the keyhole and complete the knot. Make ten loops (11 knots) in this manner, remove the gauge, turn the work over so that the needle is on the left (in netting you always work from left to right), and you are ready for the second row. It is not necessary to keep all loops on the gauge until the row is completed. Because each loop is locked into place, you can remove the gauge whenever you want to.

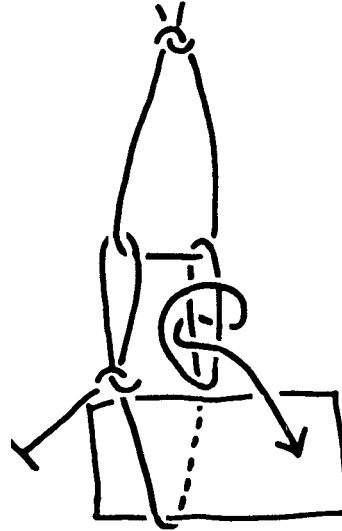

Repeat A - C using gauge to make uniform loops.

In the second and subsequent rows, you are tying into loops formed in previous rows. The knots are tied in exactly the same manner. The left hand pulls back on the work to maintain tension, and pinches each new loop in place against the top edge of the gauge until the knot is completed. The right hand guides the needle through the next loop of the previous

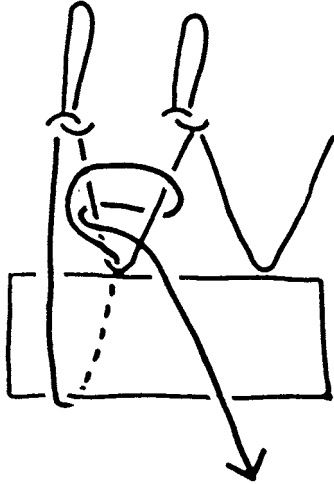

First knot of second row
row, makes the keyhole, and tightens the knot. When the half-hitch is tied into a loop in this manner it becomes a sheet bend or becket bend. The sheet bend is the basic knot of netting and must look exactly the same as shown. If the knot spills, or it is pulled tight below rather than above the 'V' of the loop, it is no good and must be re-tied. Complete the second row, turn the work over, and continue the third row from left to right. Tie a total of 20 rows for this practical piece.

You can make a handy storage bag out of this practical panel. Untie the anchor but don't remove it from the netting. Thread one end through the long legs on one side; through the end loops; through the long legs on the other side, to the top of the netting. Tie both ends of the anchor together to make a drawstring. The netting will form into a pouch when objects are placed into it.

When you run out of twine - reload the needle and with the new twine, tie a second sheet bend directly over the last

knot tied with the old twine. Continue netting with the new twine.

To increase - go around the gauge and through the same loop twice before tying the sheet bend. There will be one extra loop in the next row when you do this.

To decrease - go around the gauge and through the next two loops in succession. The sheet bend will lock these loops together and there will be one less loop in the next row.

Tubular netting is tied in the same manner. After the first row is complete DO NOT turn the work. Rather tie into the first loop you tied, joining the ends together. From here tie into each loop in succession, in a spiral, until the required length is completed. String a piece of twine through the bottom loops and tie the ends together to make the bottom of the bag. The anchor serves as the drawstring.

Projects

Suet bag - Originally used as a bait bag for fish trap. Fill with suet (beef fat) in the winter or with stale bread, apples, coconut, etc., all year long. The birds will love it!

Use 1" gauge, cast on ten loops (11 knots). Net tubular for 12 rows. Tie the bottom loops together with a separate piece of twine. The anchor will serve as the drawstring.

Onion storage bag - Onions keep best when air can circulate around them. A net bag is ideal.

Use 1¼" gauge, cast on 14 loops. Net tubular for ten rows and make a decrease. From here make a decrease every fourth new loop until six loops

remain. Tie the bottom loops together and you are ready to store onions.

Fish bag - More humane than gill stringer. Put your fish in the bag and hang the bag in deep water. It can also be used as an extra large storage bag, laundry bag, beach bag, etc.

Use 1½" gauge, cast on 30 loops. Net tubular for 30 rows (or longer if you desire). Make evenly spaced decreases until six loops remain and tie the bottom loops together.

Once you have become proficient at netting, you will want to make needles and gauges in various sizes to make finer and courser nets. The needles you use must be at least ¼" narrower than the gauge so that the loaded needle can pass through the loops being formed. Now go ahead and use your new skill to make: curtains, scarves, hammocks, garden netting, storage bags, etc.

If you are interested in further reading about net making, try *The Ashley Book of Knots*. This was my introduction to net making. It explores other techniques and contains suggestions for making hammocks, storage bags etc.

Rope Ends

A Suit of Ropes

In 1983 a pack of cards was sold at Sotheby's for £90,000. It was a beautifully preserved, hand painted Flemish pack of 52 cards dating back to the 15th century.

The point of interest to us is that instead of the suits of Hearts, Clubs, Diamonds and Spades with which we are familiar, the suits were Horns, Dog Collars, Double Nooses and ropes.

I have not been able to find an illustration of the suit markings but perhaps someone can discover it and send it to KM.

Richard Hopkins

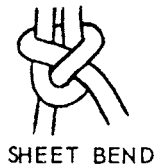

SHEET BEND

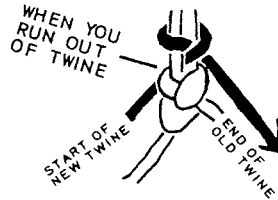

WHEN YOU RUN OUT OF TWINE

START OF NEW TWINE

END OF OLD TWINE

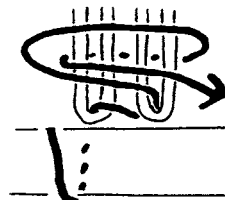

DECREASE



Incorrect Knot
Untie and Try Again



INCREASE

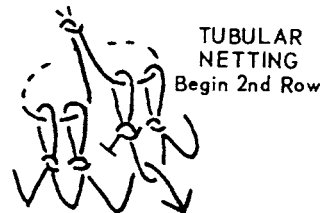

TUBULAR NETTING
Begin 2nd Row

Knot Gallery

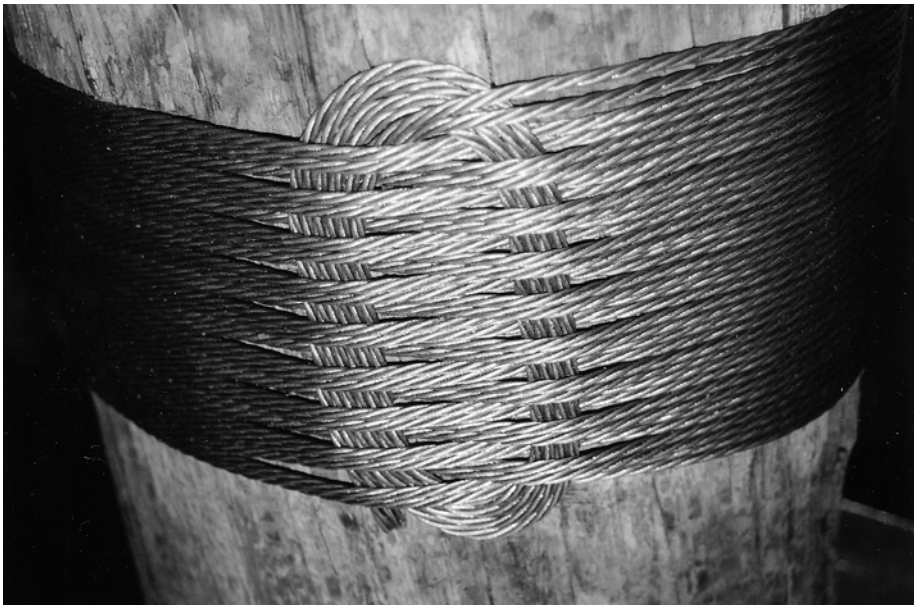

Above - Rose lashing by Raymond MacLaren with 34 plies of 5mm tensile wire.

Left - Ocean Mat by Rus Hammond, in 16 mm Manila.

*Over leaf - Picture and Frame by Jeff and Lesley Wyatt, entitled "Thames Barge"
Frame by Jeff Wyatt and pyrography by Lesley Wyatt. The frame was braided from
natural fibres and has an approximate overall size of 10" x 12"*



Cockscombing

Square knotting

Grafting

Under 2 over 2 Turk's head

Coachwhipping

Under 2 over 2 Turk's head

Continuous crowning

Under 2 over 2 Turk's head

Bellrope by Tony Doran

Length 19" (480 mm)

Core - 18 mm hemp rope

Covering - 1 mm cotton line



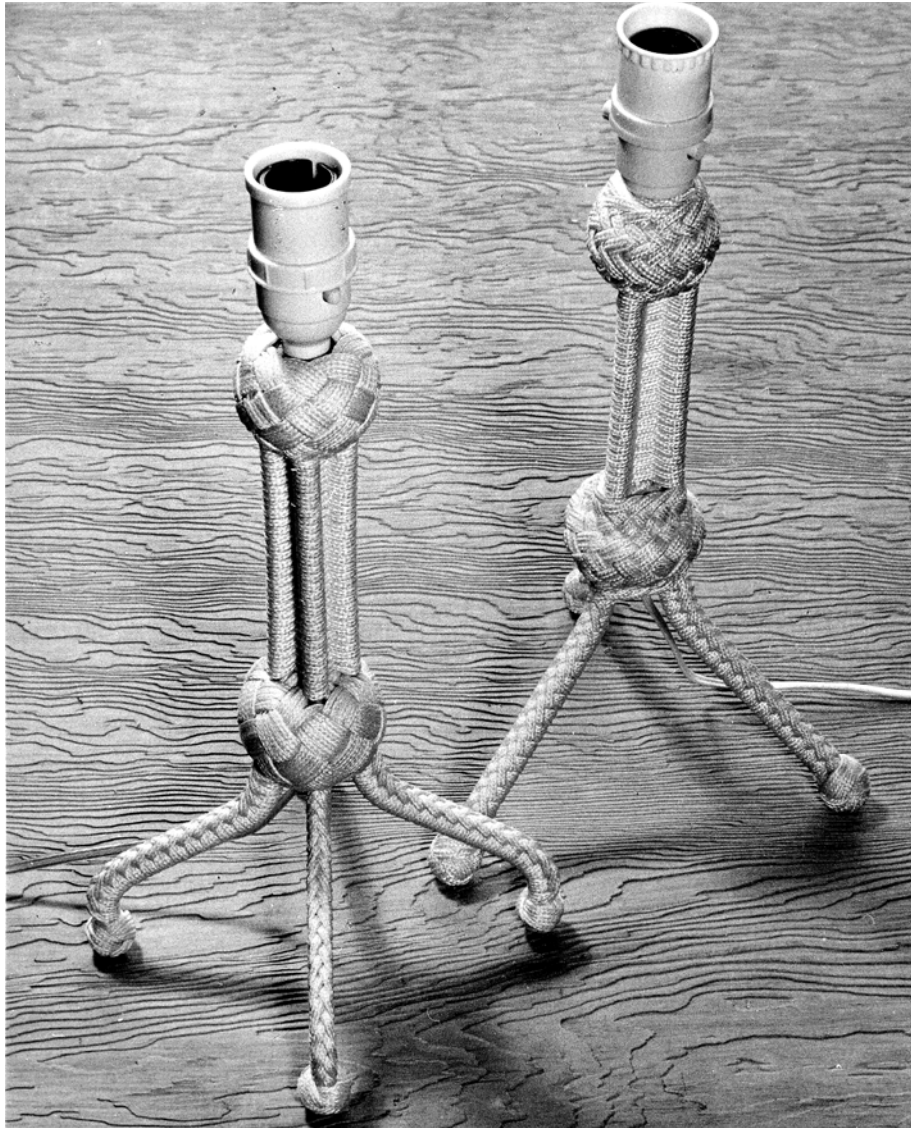

Above - Table lamps (mid 1950's) by the late Jim Nicoll, ex Shanghai detective and London river cop.

Right - Macrame mat and side fenders made by New Zealand member, Rod Orrah



The IGKT Logo Mathematically Speaking

by Skip Pennock

The family of single piece, or common, or running Turk's head knots, as they are known among English and American sailors, is one of the most attractive series of knots ever devised. They are quite ancient, with representations of them being carved into columns found in Egyptian Pharaonic tombs, for example.

They are usually cylindrical in form, but they can be tied in decorative and oftentimes practical woven flat knotting form.

Not long ago, I received two Guild 20th Birthday Celebration commemorative mugs. I was so pleased with them and their graceful beauty, that I have written the Hon. Secretary requesting a few more.

I looked upon the gold leaf sailor's breastplate knot logo, and wondered if I could arrive at a two-dimensional geometric math model of it which would be more closely true to the design than my previous Turk's head model attempts done largely in the mid 1980's. I believe I have succeeded, and hence produced this article, in keeping with the educational and science purposes of the IGKT, and perhaps also to obtain the ability to make more accurate drawings than possible before, perhaps with greater predictability.

You are likely to know more about mathematics and/or know more about flat-form Turk's head knots, than I will ever know. If this is the case, I apologise, taking into account your knowledge and your knot-tying heritage. In all probability, this work has been done before my attempts. It is simply that I do not know of these other attempts, being a relative newcomer of one year to the Guild.

The mathematics presented herein, I should say, consists of some of many anecdotal cases, for not being a true mathematician, I do not know how to generalise them into a formal proof. Furthermore, I did not make usage of commonly available computer technology to plot the polar co-ordinate graphs. I live "in the Dark Ages," and am primarily a craftsman/artist. Therefore, I instead drew them by hand with the aid of good old-fashioned polar graph paper and a simple hand held graphing calculator, which readily produces, computed tables of values.

Perhaps you have access and the ability to utilise computers, and will do so in order to produce graphs such as those shown in this article. I have heard it said many times, that mathematics is not something you watch but rather something that you do. And it is to be

read and done slowly and methodically at first, similar to learning new knots.

To address the 'Math Anxiety' aspect (a well known very real anxiety!), I will try to use conventional nomenclature as much as possible. Also, please consider the following: If you glance over the pages in this article, and it seems like ancient Greek to you, do not worry. You can understand it easily, if you can understand a compass bearing angle and range or distance as a function of that bearing angle. I maintain great expectations of you, present and future generations!

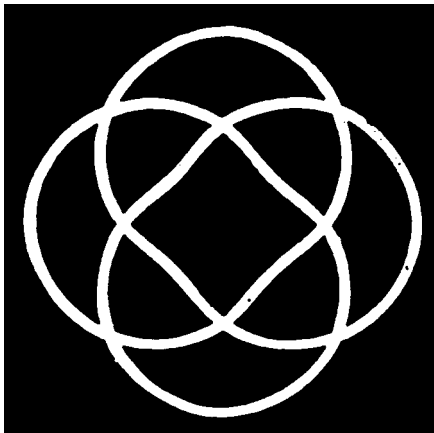

Figure 1 shows a simplified version of the first kind of model I arrived at twenty years ago, while taking a refresher Calculus I class at a local university. One day the professor asked me, "What are all those pretty little geometric drawings you make during class?" I explained, and she suggested I use Polar (R,U) co-ordinates directly, instead of the familiar Cartesian (X & Y) co-ordinate graphing system.

Figure 1 is actually a black and white image of a colour acrylic painting rendered in white, yellow, orange, red,

and burgundy in 1989. The modelling equation of the curve, outlined in white, is simplified to, and enlarged from:

$$\text{Radius} = 2 + \cosine \left(\frac{4\theta}{3} \right)$$

$$\{0^\circ \wedge \text{Theta U, or Angle} < 3 \times 360^\circ\}$$

Because the Cosine of anything ranges from -1 to 1, the radius R varies between $(2-1) = 1$ unit, and $(2+1) = 3$ units. This Figure 1 shows a vague resemblance to the Guild's symbol.

The generalised version of this first model is the following:

$$R = R_{\text{mid}} + \text{Acoss} \left[\frac{B\theta}{L} \right]$$

Some Definitions are in order:

R_{mid} is a Midrange radius constant, which is greater than A.

A is an Amplitude constant, which is equal to ½ of the Width of the braid.

B is the number of Bights, a positive integer parameter.

L is the number of Leads, a positive integer parameter, greater than 1.

B, Bights, and L, Leads, are in their lowest possible terms, without any common factors.

U, Theta, is a measure of Angle; It is the independent variable, and:

$$\{0^\circ \% U < 360L^\circ\}$$

when angular measure is in the form of degrees. (There are 2π radians for every 360° , if you are using radians to measure angles.) Theta roughly speaking is a bearing angle, similar to a compass bearing direction angle, except that by convention, it rotates positively in a counter-clockwise direction from a

given starting orientation, which is usually the Cartesian "X" axis.

R, Radius, is a measure of Distance from the graph's centre point; it is the dependent variable, depending upon an inputted value of the Angle U, Theta.

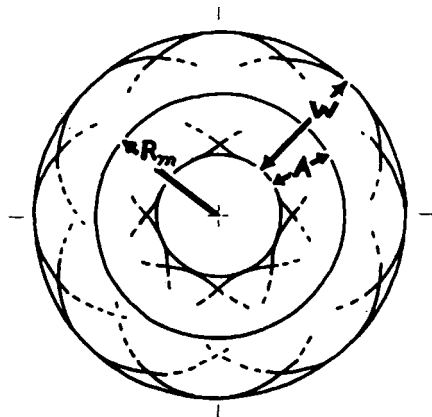

Figure 2

See Figure 2 for a diagram explaining Rmidrange, Amplitude, and Width of Braid.

The equations are truly quite simple. If the Radius R equals a constant fixed number, regardless of the Angle Theta, then we will produce the graph of a Circle. If an appropriate wave is added to the circle, then we can make a wavy braided circular Turk's head knot graph which will have the right number of bights and the right number of leads.

A Cosine wave was chosen for the model, because at its start where Theta is equal to 0°, the wave has its maximum value. This makes the modelled Turk's head knot symmetric about the bearing Theta = 0°, unless a term is thrown in to rotate the Turk's head knot graph, but that's another subject in itself.

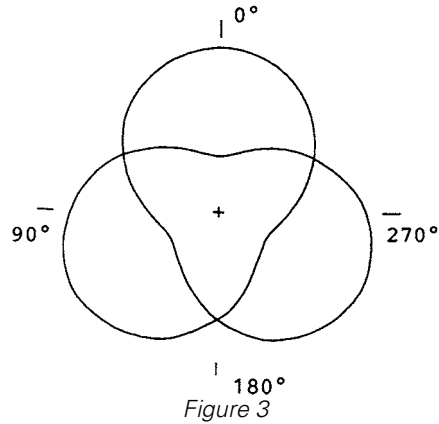

Figure 3

Figure 3 shows a model for the centreline of a piece of cord forming the simplest of Turk's-Head knots, the Trefoil knot. Of course, the number of Bights is 3 and the number of Leads is 2. Amplitude is set to implicitly equal 1. Its equation is:

$$R = 2 + \cos \left[\frac{3\theta}{2} \right]$$

Where $\{0^\circ \leq \theta < 720^\circ = 2 \times 360^\circ\}$

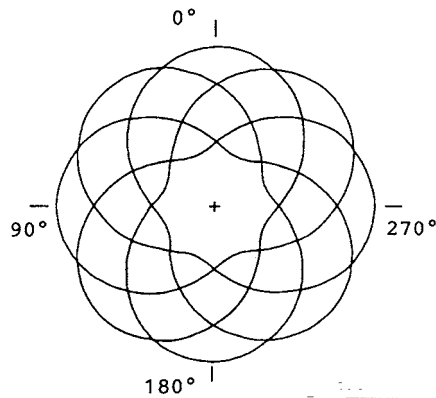

Figure 4

Figure 4 shows a model for an 8-Bight, 5-Lead, Turk's head knot:

$$R = 2 + \cos \left[\frac{8\theta}{5} \right]$$

Where $\{0^\circ \leq \theta < 1800^\circ = 5 \times 360^\circ\}$

These last two equations were plotted with a felt tip marker in the early 1980's, before graphing calculators became widely available.

The model helps explain a curious fact about single-piece, or common, or running, Turk's head knots: namely that *the number of Bights and the number of Leads may have no common factor (or, divisor), for if they do, the factor will cancel out in both the top and the bottom of the fraction of B/L; that is Bights over Leads.* In such a case, the resulting modelled knot will have both fewer Bights and fewer Leads, or it may not form a braided knot at all.

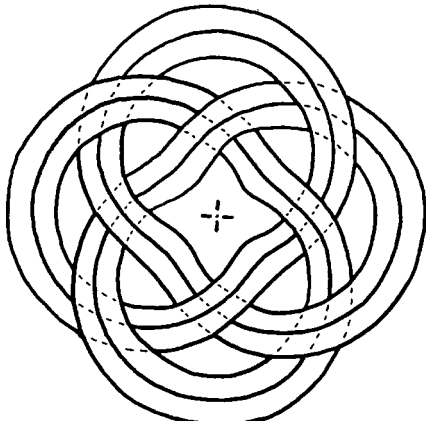

Figure 5

Figure 5 more closely resembles the doubled Breastplate IGKT emblem. The figure actually shows the plot of three

equations, compressed and expressed as one, through the usage of braces:

$$R = \{1.6 \ 2.0 \ 2.4\} + \cos \left[\frac{4\theta}{3} \right]$$

It has three Midrange radii, as noted within the braces.

Its maximum Radius makes use of the largest midrange radius, and is figured as:

$$(2.4 + \text{Cosine } 0^\circ) = (2.4 + 1) = 3.4 \text{ units.}$$

It has been resized to fit on the printed page, and for comparison purposes, despite its larger size. Its middle Midrange radius remains as 2 units, as in the case of Figure 1. Its minimum Radius is computed as $(1.6-1)$, or 0.6 units, first achieved at $\text{Theta} = 135^\circ$ which = $(\frac{L}{B} \times 180^\circ)$ or $(\frac{3}{4} \times 180^\circ)$.

Something that is surprising is that not only does the sailor's breastplate knot, for example shown in Figure 1, work with a Plus Sign between 2 and the Cosine function in parentheses, But that the equation also works when 2 is Raised to the parenthetic Cosine function.

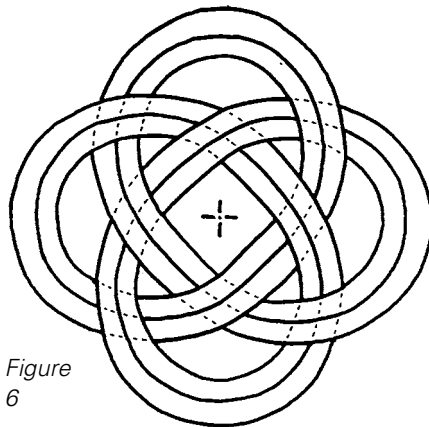

Figure 6

Indeed, *Figure 6* shows a second kind of model, a Power function, which yet more closely looks like the gilded Guild logo on the Y2K2 20th Birthday mugs and also on the cover of *Knotted Matters*. It also is formed of three equations combined into one:

$$R = \{0.0 \ 0.3 \ 0.6\} + 2 \quad [\cos(4U/3)]$$

Again $\{0^\circ \leq U < 1080^\circ = 3 \times 360^\circ\}$

Because $2^{-1} = 1/2$, the minimum Radius of the innermost curve in the equation is $(0.0 + 1/2) = 0.5$ units.

The maximum Radius of the outermost Curve is $(0.6 + 2^1) = 2.6$ units.

Therefore, this *Figure 6* has been enlarged, in relative terms, to equal the size of *Figure 5*.

It was this last doubled, formed of three-equations-into-one equation, upon which I arrived during the days after receiving the mugs, with the great help, as mentioned, from a hand held graphing calculator.

I hope you enjoy playing around with these equations, modelling with them, or

Figure 7

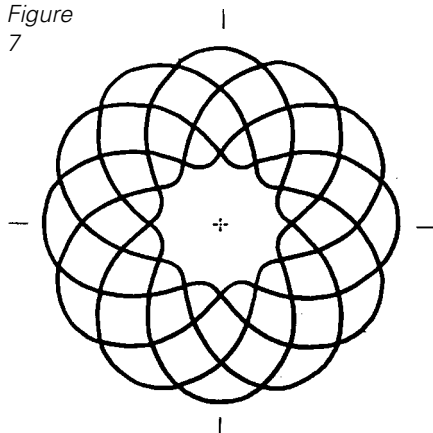

others entirely different from them, such as Bowditch's Parametric Equations which model rectangular knots, and which can model other knots such as overhand or figure eight knots with disconnected cord ends.

One thing the mathematical models do not graph is the alternating (basket) weave structure in the final form of tied flat Turk's head knots.

Here are some additional example possibilities of Turk's head knot modelling:

In Figure 7:

$$R = 2 + \cos \left[\frac{12\theta}{5} \right]$$

which has 12 Bights & 5 Leads. The maximum Radius is 3 units, as is for this 7-Lead Turk's head knot, shown in *Figure 8*:

$$R = 2 + \cos \left[\frac{12\theta}{7} \right]$$

Figure 8

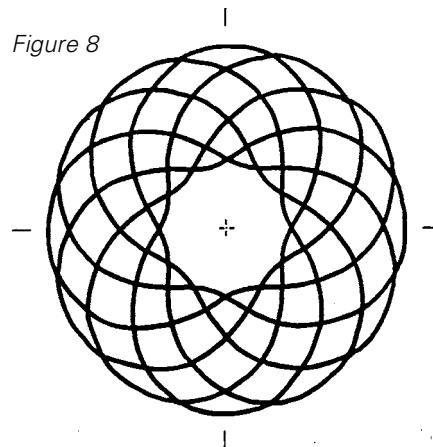

Another trefoil knot (which is just an overhand knot with its cord ends connected together), is shown in *Figure 9* as a Power Curve:

$$R = 2 \quad [\cos(3U/2)]$$

The maximum Radius is 2 units.

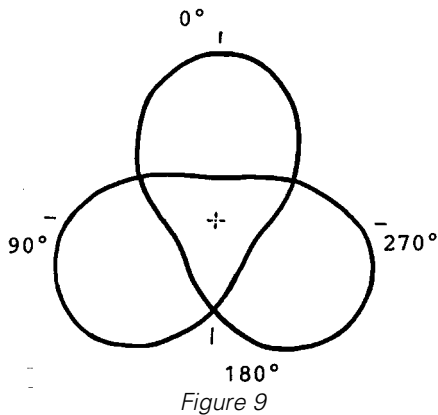
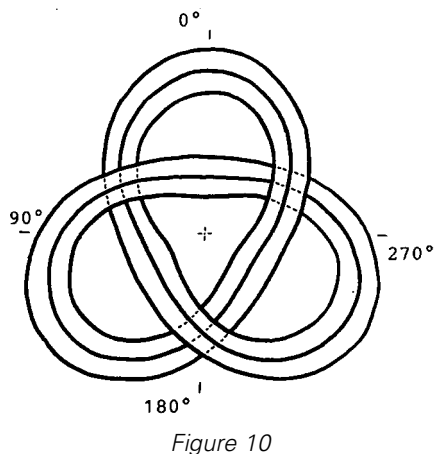

Figure 10 is a doubled trefoil knot, as three power curves in one equation:

$$R = \{0.0 \ 0.3 \ 0.6\} + 2 \quad [\cos(3U/2)]$$

The maximum of the Radii is 2.6 units



A figure eight knot, with the cord ends connected together, creates a projection of it in its most symmetrical form, which is a 2-Bight, 3-Lead flat Turk's head knot. It is shown here in Figure 11, expressed as a Power Curve:

$$R = 4 \quad [\cos(2U/3)]$$

The maximum radius = 4 units

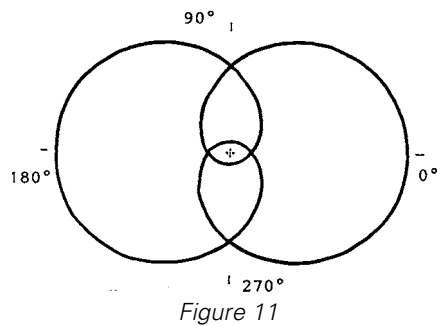

Why not try a 7-Bight, 3-Lead Turk's head knot with a positive rotation by T°?:

$$R = 2 + \cos \left[\frac{7(\theta - T^\circ)}{3} \right]$$

Have fun tying, drawing, doodling, modelling and applying Turk's head knots!

The author would like to thank Europa Chang Dawson for suggestions in proof reading and readability of this article. His *Decorative Woven Flat Knots* is not a mathematics book, but it is overwhelmingly a craft book. It is available from the Guild Supplies Secretary and from other outlets.

Webbing Knots - Part 4

by 'Jack Fidspike'

This closing feature in my series on knots that can be tied in tape or webbing is the cue for KM readers to send their own favorite webbing knots, tips and techniques to our editor

Colin Grundy for possible publication by him in future issues of the magazine. Meantime, here are my final hitch, bend and a couple of knots.

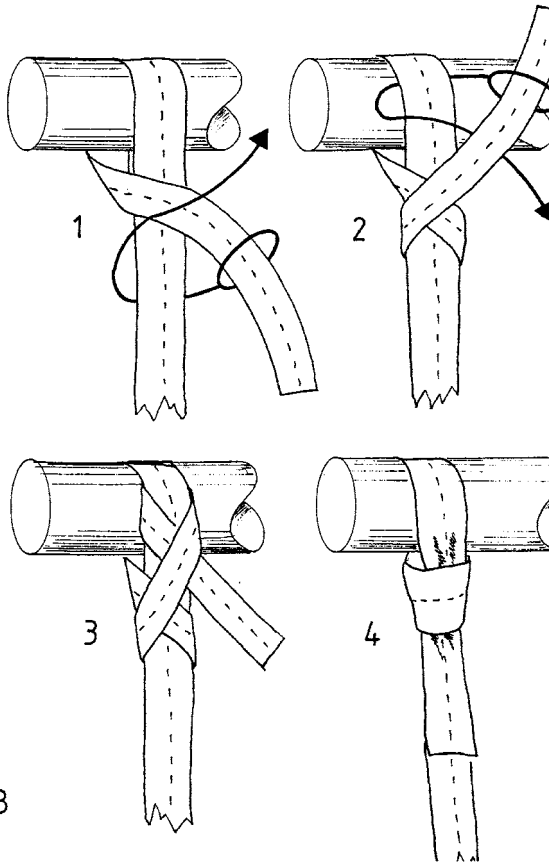

Buntline hitch

Tied in flat material this old seagoing hitch turns into the common necktie knot, still correctly referred to as the 'Four-in-Hand' after the 18th century gentlemen's club of that name whose members adopted it to replace their outmoded cravats.

Carrick bend

The carrick bend - with ends on opposite sides - is not an obvious choice for a webbing knot, but it works well enough as long as unwanted twists are carefully eliminated before the knot is tightened and capsized into its final form.

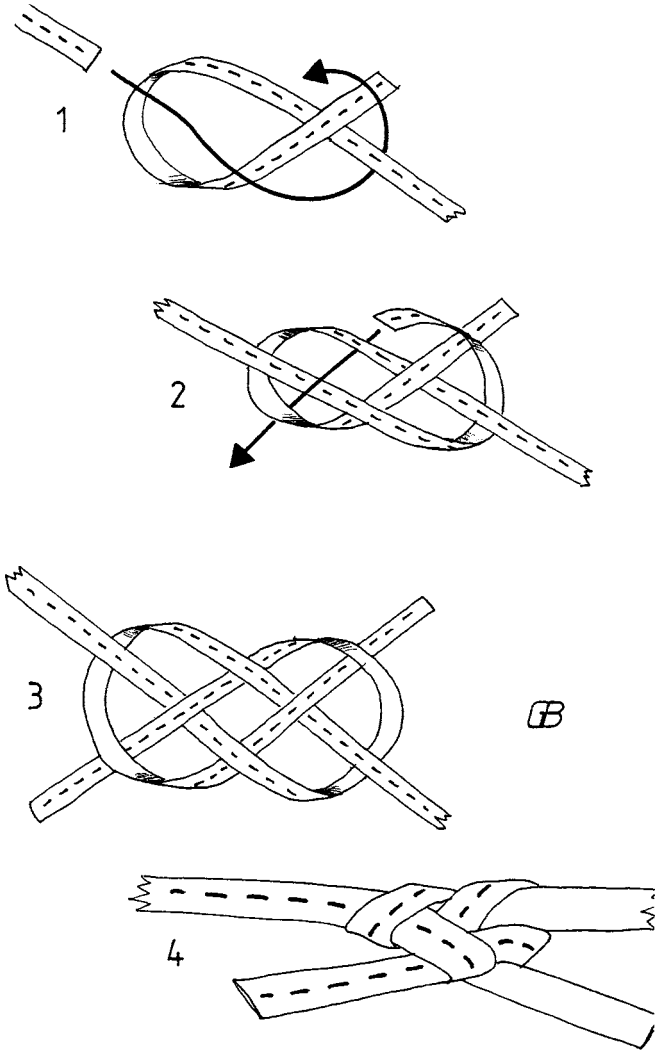

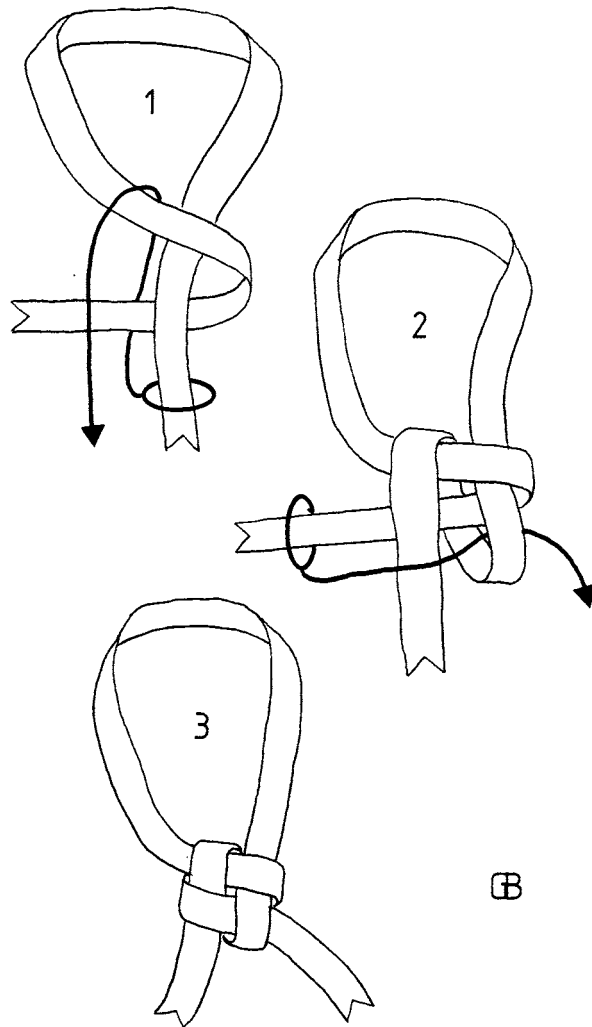

Square knot

Use this compact and good-looking knot to turn an off-cut of webbing into a chic bit of neck-wear, the knot neatly filling the V-space of an open necked blouse or shirt, while the two ends hang at jaunty angles, as an eye-catching fashion accessory.

Pyramid knot

The knot is so new that no particular application - practical or decorative - has yet, as far as I know, been found for it. That is no criticism. It could be worn as a lanyard knot around one's neck; or a close-linked series of them might be made into a chunky bracelet. Perhaps a large enough specimen in tough paper could be used to gift-wrap small presents ... or employed to re-sharpen used razor blades. (Older readers will recall the cardboard 'magic' pyramids, sold by post-WWII mail order companies, who claimed their product did precisely that by somehow focussing Earth's magnetic field!) This knotted pyramid, however, was devised by Guild member Robert M. Wolfe, M.D. of Chicago, USA, and published in KM #65 (December 1999).

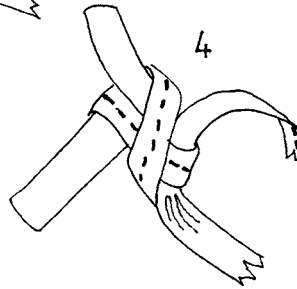
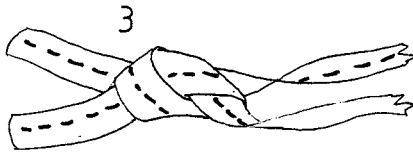
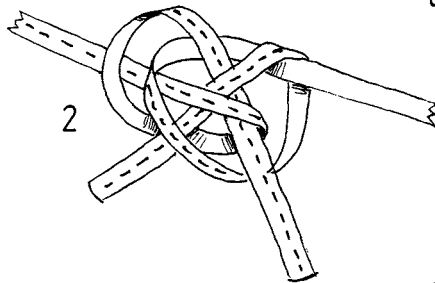
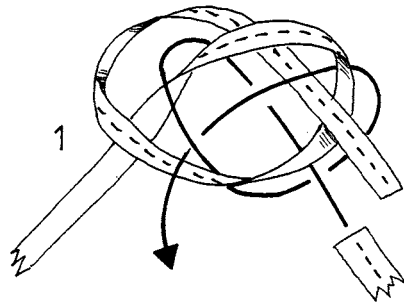

B

An Alternative Notation for Knot Diagrams

By Dick Clements

The classical means of describing or defining a knot diagrammatically is undoubtedly familiar to all knot enthusiasts. A knot may be drawn in two dimensional form with, at each crossing, the cord passing over being drawn as a continuous curve and the cord passing under being drawn with a break on each side of the crossing. Thus the bend known alternatively as the rigger's bend or Hunter's bend may be represented as in figure 1.



Figure 1: Classical knot diagram for the rigger's bend

I have recently been pursuing work which involves manipulating bends from one form to another and, in the course of doing this, I needed to sketch by hand a large number of knot diagrams in order to record the manipulations. I found that, whilst the classical form of diagram is excellent for formal use, sketching the bends with the breaks in the correct place is a slow and laborious process. For instance to sketch the rigger's bend one

first needs to draw one cord, leaving breaks in the correct place for the other cord, as in Figure 2. Then the other cord must be added trying to ensure that a smooth curve passes through the correct gaps in the first cord. In practise I have found that obtaining clear, well formed knot diagrams in this way is far from easy.



Figure 2: First Stage in drawing a knot diagram for the rigger's bend

Hence, in order to produce a sketch of a bend quickly and easily, I devised an alternative way of representing the bend. This method can be applied to any knot and is particularly suited to drawing knot diagrams when recording on paper a diagram for a real physical knot in a piece of cord or rope. The method starts by drawing a continuous curve to represent each cord without worrying, at this stage, which cord passes over and which under at each crossing. For the rigger's bend this gives the diagram in figure 3.

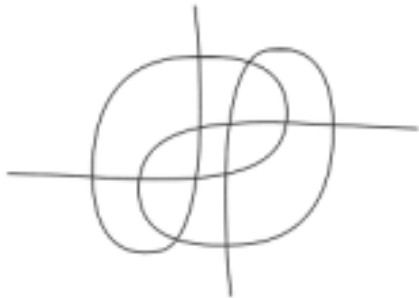

Figure 3: First stage in drawing the alternative knot diagram for the rigger's bend

Next a parallel line is added to each cord which does break where a cord passes under another cord at a junction. Thus, for the rigger's bend illustrated, the second stage would produce the diagram in figure 4.



Figure 4: Second stage in drawing the alternative knot diagram for the rigger's bend

Finally, at each crossing, the space between the parallel lines of a cord which passes over itself or another cord is blocked in. Thus, for the rigger's bend, the third stage would produce the diagram in figure 5.

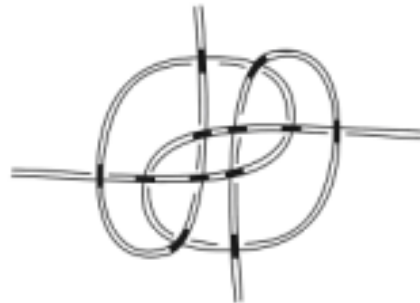

Figure 5: Third stage in drawing the alternative knot diagram for the rigger's bend

Obviously diagrams drawn in this notation are not quite so clear as the classical style of diagram but they are much easier to draw quickly and accurately. I find it a useful notation for recording working diagrams some of which may, at a later stage, be transcribed to the classical form.

Tied in knots

A knot has been found in a protein made by a primitive bug called *Methanobacterium thermoautotrophicum*. While knots in proteins aren't unheard of, they are still rare. And now one knows how they form or how they affect protein behaviour.

Finding a knot in such an ancient bacterium indicates that they must have some use, says co-author Andrzej Joachimiak from Argonne national Laboratory in Chicago. "Evolution doesn't hold on to things it doesn't need," he says. Perhaps the knot might help the protein hold together at high temperature, he suggests.

New Scientist
December 2002

Branch Lines

West Country Branch

At our July meeting, Ken Yalden gave a very informative and interesting talk on the Starbolins, those members of the Guild who like to dress up in 18th century uniforms. The many tales and incidences that have happened to Ken and the Starbolins made for a very enjoyable afternoon.

The 21st September saw some of our members at the Keynsham Craft Fair, manning a stall of items made by the branch. We had a wide range of produce for sale but unfortunately people were not buying. We did have a lot of interest in the branch and the Guild and if all these enquiries bear fruit both the branch and the Guild could benefit. The September meeting was one of our 'learn and tell' sessions. Members pass on their knowledge to others with hands on activities. Two knots on which several members require clarification were the Mathew Walker and the star knot. A couple of different ways of tying both were demonstrated and the members present had something with which to pass the time over the rest of the weekend.

In October we gave a talk to a group of ladies known as the Portbury Wives Group. Everyone had a pleasant evening learning about the Guild and knotting.

'Tug' Shipp

French Branch

Next year, we shall be holding the 4th French Knot-tying weekend over the 27th to 28th March. It will be held in the Rouen Maritime Museum.

The museum, established in 1980 occupies a former portuary hangar, built for the Schiffino Company in 1926. The collection comprises many objects from the merchant navy and the Port of Rouen, including ship models, marine engines, navigation instruments as well as a barge, tugboat and other small workboats. It also puts on temporary exhibitions. Check out the website for more details - www.musee-maritime-rouen.asso.fr/

For comfortable accommodation in Rouen, look up - www.rouentourisme.com

Graham macLachlan

NAB 2003 Meeting, Virginia.

I would like to say a big 'Thank You' to all who made both Lesley and I so very welcome at the NAB 2003 meeting held last month in Newport News Virginia.

Right from the spontaneous reception received as we arrived in the foyer of the Hotel through to the farewell wave given by my good friends John and Carole Cushman on the Interstate 64 as they left us as we headed for the airport after spending four days showing us the wonderful sights of Virginia, Wal-mart and Sam Adams!

This had been, in my opinion, the perfect way to conclude what had turned out to be a really good gathering of

enthusiastic Knot Tyers held at a superb venue.

Finally I wish 'Good Luck' to Steve Coates and John Cushman in the future forming of a New England chapter of the NAB.

Ken Yalden

NAB AGM

In the middle of October Lesley and I visited Virginia in the eastern United States, partly to have a holiday and partly to attend the AGM of the North American Branch on the Guild.

We met up with Gordon Perry, Ken Yalden and Lesley Bell at Heathrow, and after an uneventful flight arrived safely at Dulles Airport, Washington. We picked up our rental car, and headed south for Newport News. Some four hours later we found our hotel, the Point Plaza, and booked in. We briefly met Ken, Lesley and Gordon in the foyer, plus Bruce, Linda and James Turley. Also some familiar American faces - Robert Black, Gary and Barbara Sessions, Ed Morai, John and Kay Burke, Steve Coates and Keith Hudson. Unfortunately by this time we were pretty tired so we decided to get some sleep in order to be well prepared for the meeting the following day.

The meeting was held at the Maritime Museum in Newport News - what a perfect venue.

Once we had all set up our displays, the first day was spent having the main meeting and a series of Masterclasses - which attracted interested members throughout the three days.

On the Saturday we moved everything into the main foyer of the Museum and

so were available for the visitors to the Museum to be entertained and shown the mystiques of the knot. John Cushman, Ken and Gordon manned the 6-Knot Challenge, which grabbed the attention of adults and children alike. Most visitors were sufficiently intrigued by "what can be done with a piece of string" that they walked around the various tables admiring the different displays of knotwork from both the US and England. Another important item: Saturday was James Turley's 18th birthday. James was a bit disappointed that he had to abide by US law that stipulated that he could not drink until the age of 21, the UK the age limit is 18!

Also on Saturday was the first-time telephone link-up with the Half yearly AGM in Ipswich, Suffolk, England. This went off very well in America as we were on "hands-free" and could all chat at once. Congratulations to Des Pawson and Terry Barns in England, and John Burke and Ed Morai in the US for all their efforts to make this historic event run as smoothly as it did.

Sunday continued the Masterclasses and meeting with visitors to the Museum. There was also time to have a look around the Museum itself, which is well worth a visit if anyone's in the area. One especially interesting exhibit was the "Monitor" or rather pieces of it that have been brought up from the sea bottom.

Many thanks to John and Kay Burke, and the other members involved, for all their hard work in organising such an enjoyable occasion. We have even more American friends to look out for at the next US meeting we attend!

Jeff Wyatt
Guild President

Postbag

The views expressed in reader's letter do not necessarily reflect those of the Council. The Editor reserves the right to shorten any letter as necessary.

Who will Teach 'Em

With reference to Geoffrey Budworth's letter (KM 79, Splices-Who needs 'em?). The reason I joined the Guild was to learn ropework that had not been passed down from the old sailors down to the new ones. I am pleased to say that from a lot of Guild members (including Des & Liz Pawson, Stuart Grainger to name just a couple), my knowledge has increased a lot, thanks to the Guild. If we take Geoffrey's cue and put splices to one side, then who is going to teach the new sailors how to splice in the future? As I have said in my previous letter's to *Knotting Matters*, the Merchant Seaman still has to learn to splice both rope AND wire in order to pass his exams. Nowadays, wires come ready made with ferrules, but when you are at sea and you need a wire splicing, if we take Geoffrey's advice, then no one is going to be able to do it. I thought that the IGKT was set up to promote ropework and keep an interest in this dying art. So Geoffrey, we dump splicing, because you think there is no place for it, what's next on the agenda, getting rid of rope? I conclude with the thought "Think before you compose a letter!"

*Paul L Evans
Hartlepool, UK*

R Hood Haggie & Son

Replying to Colin Grundy's query concerning the present status of R. Hood Haggie & Son, in KM80 (page 47). The ropeworks at Willington Quay, Wallsend, Tyne & Wear, are still in production, but now operate under the name of Bridon International, and are part of the international engineering group, FKI plc. On Tyneside they are still referred to as Haggie's ropeworks.

The family founder, David Haggie, arrived on Tyneside from Scotland in the early 1800s (I have some information which I haven't yet been able to confirm; that his mother was a Jane Hay, a member of a well known Sunderland ropemaking family). He started a ropewalk in partnership with a Mr. Pollard on the salt meadows at Gateshead.

Between 1809 and 1825 Haggie had three sons, Robert Hood, David, and Peter, who all, in due time, entered the business, the name changing to Haggie Brothers. In 1843, after a falling out, Robert Hood Haggie left the business and took up a lease on a vacant ropery at Willington Quay, Wallsend, this was over the River Tyne and six miles downstream from Gateshead. David Haggie, the founder, died in 1851. Son David, who was more interested in local politics (he was mayor of Gateshead in 1854), eventually sold his share of the business to his younger brother, Peter. This David had two sons, David Henry, and George, who also got the ropemaking bug and set up in partnership in 1879, when they took over Hay's Ropery (yes, the same Hay family as mentioned earlier), at Sheepfold, Monkwearmouth, Sunderland. The business was named D.H. & G. Haggie,

hence the three ropeworks named Haggie in the Tyne and Wear area.

There were at least a couple of dozen ropeworks on Tyneside in the 19th century, a good many of them craft orientated and small, which were the first to go to the wall; amalgamations and takeovers started in the 1850s. The first big merger came in 1924, when eight local companies formed British Ropes Limited (including Haggie Brothers, and D.H. & G. Haggie), this soon snowballed nationwide, and by 1927, 30 companies had joined the merger.

After the Second World War British Ropes Limited entered another period of expansion, as did R. Hood Haggie and Son. However, later, in 1959, R. Hood Haggie & Son, one of the UK's largest independents, finally succumbed to British Ropes many overtures and joined the group. In the early 1970s there was a major reorganisation, and a drastically slimmed down group was renamed Bridon. In July 1997, Bridon was taken over by FKI plc, an international engineering group, although it still operates under the name of Bridon.

The family name still lives on in Haggie Rand, South Africa's largest ropemaker. Gordon Haggie, one of the Geordie Haggie's, started the company after the First World War, in Johannesburg.

Looking at the accompanying illustration, I notice that the manila towing-spring has a right-handed cable lay. Although contrary to general practice this is quite normal in towing, as all components in the towing rope must maintain a common lay throughout the rope's entire length. The ropemaker's preferred option was to reverse the four stages of twisting, in making up the manila towing-spring, rather than

construct a length of left laid wire rope to make-up the two wire pennants.

Thomas Simpson
South Shields, UK

Mirror Images

The pair of chest becketts pictured on page 25 of KM80 (September 2003) were first displayed by Guild newcomer Barry Brown at the IGKT's 21st AGM in Weston-Super-Mare on 10th May 2003, where he pointed out to me that they are perfect mirror images of one another. Each and every bit of knot work on one has been painstakingly reversed on the other, making them into a remarkable apprentice piece.

Geoffrey Budworth
Tonbridge, UK

Aviation Splice

In reply to the letter from Andrew Lyle in K.M.80 about an end terminal fitting.

During my recent summer holiday I bought a second-hand book, mainly for one illustration and paragraph, although there was a lot of other fascinating information also present.

The book was *Anchors and Mooring for small craft* by Lt-Col A. T. Colin, originally produced in France in 1961 by Editions du Compas, but my edition was translated and produced in 1963 by The Maritime Press. From comments in the book it would appear that the colonel

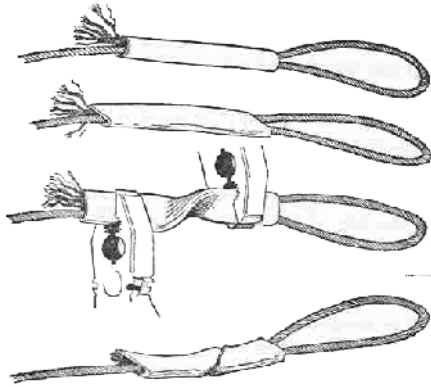

was a French amateur yachtsman who had designed several patterns of anchor.

The paragraph that caught my eye follows a short discussion on the strengths of various ropes and splices.

"I cannot, however, refrain from mentioning the very simple eye-splice known as the 'aviation splice' which may not be beautiful to look at but whose use for splicing rudder and aileron cables sufficiently vouches for its reliability - and it can obviously be done very rapidly: Pass the cable through a short tube (5 to 6 inches) of annealed copper, of a section one-and-a-half times that of the cable to be spliced. Bend the cable back on itself to form the eye and re-introduce the loose end into the tube in the opposite direction, flattening the tube slightly if necessary; then crush the tube flat with a hammer, twist it in the centre through 180° and again beat flat. The steel strands will be embedded in the softer copper, which, having been annealed, will not fracture, and they cannot slip out. The whole job hardly takes two minutes and the splice is practically indestructible; it goes without saying that the quality of this speedy repair will begin to deteriorate after a few months if and when thermo-electric

action between the copper and the steel begins to produce corrosion."

If permitted by the wartime RAF, this would also have saved Percy Blandford from some perforated thumbs, but he would not then have acquired such expertise in conventional wire splicing.

I don't know if this will help Andrew, but it is the first reference I had seen to this splicing technique. I hope other members of the Guild can spread more light on this.

*Richard Hopkins
Bristol, UK*

A Bowline Too Many?

I am making a study of bowlines. I have come across the following bowlines: reverse Carrick bend bowline; Carrick bend bowline; water bowline; slip noose; French bowline; double caulker's chair bowline; double chaise de calfat bowline; French bowline-on-a-bight; simple bowline; double knotted bowline; interlocking round-turn bowline; fool's bowline; round-turn hitch bowline; angler's loop bowline; perfection bowline; Algonquin bowline; fisherman's bowline; Irish bowline; figure of eight bowline; enhanced double bowline; double bowline; round-turn bowline; jam bowline; triple bowline; true bowline; painter's bowline; interlocking bowline; Lark's head Spanish bowline; bow bowline; inverted bowline; back bowline; clinch bowline; thumb bowline; Brummycham bowline; Portuguese bowline; enhanced bowline; lock bowline; Ontario bowline;

slip bowline; twist bowline; Spanish bowline; double Spanish bowline; belt & braces bowline; double bowline-on-a-bight; slip noose bowline; pulley bowline; bowline; reverse bowline; ring bowline; stopper bowline; running bowline; bowline-on-a-bight; left-handed bowline; Linesman's bowline.

I would be very pleased if other members could let me have the names of other bowlines and how to tie them of course. Also some bowlines have alternative names, so I would be pleased to receive them too.

*Harvey R R Wallace
Isle of Wight, UK*

Beginners Knots

I read with disbelief the 7 page article "Which Knots for beginners" in September's *Knotting Matters*. I first learned knots in the Scouts nearly 50 years ago. I am still a member of the movement and have an appointment as a pioneering instructor although I'm not very active.

There is not, and there never has been, any knot in the Scouting manual more complicated than tying a shoelace. It is a knot requiring considerable dexterity yet most youngsters can tie it by the age of nine. Why! It is a matter of incentive. A child who couldn't tie its own shoelace before the age of nine would die of embarrassment - so they learn.

When I was a Scout all those years ago all Scouts could tie knots and it had nothing whatever to do with my "growing up on a farm" I didn't, nor did I "handle rope every day from early childhood". Nor did any other

Scouts in the troop have such a background. We learned because in

those days being a Scout who couldn't tie knots would be as embarrassing as being a lifeguard who couldn't swim. We wanted to be Scouts and one of the things that marked you out as a Scout was an ability to use rope.

Today Scouts no longer feel embarrassed if they are not too good at knots. Chances are their leader can't tie knots either. Pity but there it is.

While I, like other members of IGKT will happily sit playing with a piece of cord and derive pleasure from it, young people today have no desire to learn knots 'for the fun of it'. The purpose of knots and rope work in Scouting is in order to build things. If a Scout knows that the plan is to say build a raft then, he will be persuaded to learn some knots that will help him do it because he can see some purpose to it.

Which knots to teach is purely based on what knots are needed?

The first knot I would choose to teach is the timber hitch. So simple that you may have to persuade a Scout that it really is a knot. It is a very secure knot in Scouting type applications i.e. Tying a rope to a spar, tree or picket.

The next thing I would do is to get them to tie a series of half hitches around a broom handle or something. Just to get the feel of them. I might point out, especially if any of the Scouts were girls, that what they are doing is in effect blanket stitch. The half hitch is arguably the most important knot there is and the simplest.

To teach the most vital piece of rope work in Scouting, a square lashing, I would start with a timber hitch. Put on three wrapping turns. Change direction. Put on two frapping turns and finish with a half hitch round a spar. Work the half

hitch tight into the corner then add another half hitch to lock the first.

I personally would drop 'clove hitch' from the book. It is not secure when used as a hitch, certainly not as secure as a timber hitch and although it is the same as two half hitches you get better results if you teach 'lock it off with two half hitches' than 'finish with a clove hitch'.

Frequently in pioneering you have to bring a structure vertical and tie off the guys. The only knot I know that you can tie against the pull of a rope is a round turn and two half hitches. A round turn is hardly difficult and we have already covered half hitches. In my view it should only be used when the rope is under tension or where you have a small diameter metal stake where a timber hitch won't work.

To tie two ropes together you make a loop in one. Pass the end of the other rope through it and tie a half hitch around both strands of the loop. Called a sheet bend. The best knot for that purpose when pioneering because it can be undone afterwards.

The tripod lashing can start with a timber hitch and end with two half hitches. Likewise a sheer lashing. I see no point in teaching a diagonal lashing. I am not convinced it does anything sufficiently different to a square lashing. Nor would I teach a sheepshank. I have never found it useful.

A reef knot is the only knot you can use to tie two ends together under tension. It is needed in first aid anyway so I would include it. I don't like the "Left over right and under" method. The best way I know is to tie an overhand knot. Take one end back on itself to form a loop. Then it is easy to see what you need to do with the other end to complete

the knot. After a bit of practice the "Take one end back on itself to form a loop" need only be done mentally.

The waggoner's hitch is a very useful knot for getting a rope really tight but I would not recommend it because it can fall apart while you are trying to tie it and because if anything gave it a knock, it could result in a capsized which is dangerous. The alternative I use, which I have called the trailer hitch is both simpler and safer. (I don't know whether it is original). Again it ends with the ubiquitous two half hitches.

To make a fixed loop I would use a bowline. It has the advantage that with practice you can tie it with one hand while holding on with the other and it can be untied after tension has been applied even when wet.

Unfortunately a lot of the methods taught only work if you are standing behind the spar you are tying a loop around while in practice you may be trying to reach out and tie it around a spar in front of you. The method I have always used is - Take the rope around the spar. Take the working end over the standing part and back under to make an overhand knot. Pull the working end until it is straight transferring a loop into the standing part. Take the working end under the standing part and back down through the loop.

Choosing knots in Scouting is based on need. If you really needed a very complicated knot you would have to teach it. Luckily you don't. I don't think any of the knots I have described are difficult, neither do I think that I have had to compromise in choosing them.

John Kennaugh
Callington, UK

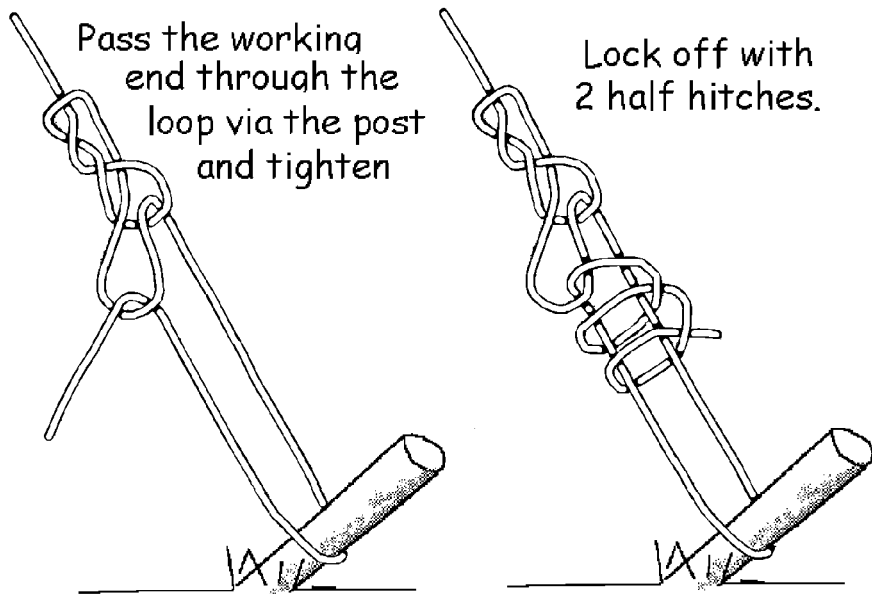
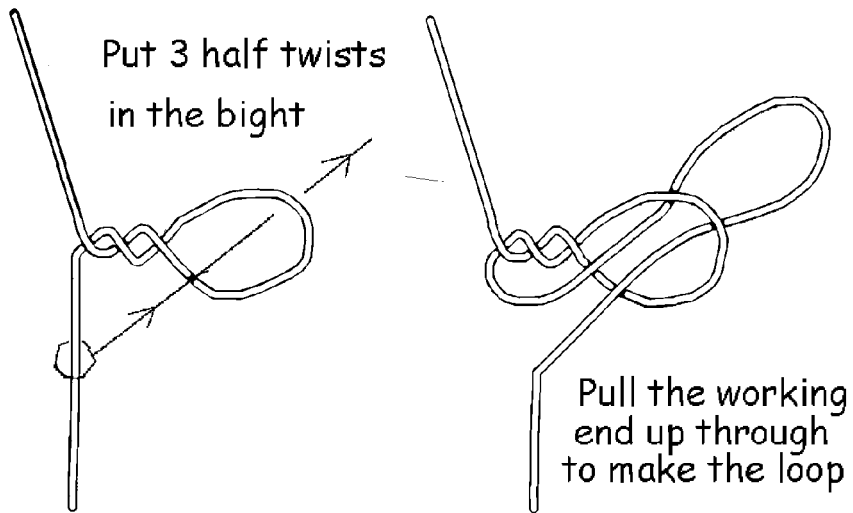

THE TRAILER HITCH

John Kennaugh

Knotting Diary

AGM's & 1/2 YEARLY MEETINGS

22nd AGM

7th - 9th May 2003
Chatham Historic Dockyard, Kent
Contact: Nigel Harding
Tel: 01825 760425

Half-Yearly Meeting

8th - 10th October 2004
Pitsea.
Details to follow

BRANCH MEETINGS

Midlands Branch

9th February 2004
19 Windmill Avenue, Rubery, Birmingham
Contact Bruce Turley
Tel: 0121 453 4124

East Anglian Branch

3rd April 2004
Museum of East Anglian Life, Stowmarket,
Suffolk
Contact John Halifax
Tel: 01502 519123

French Knot Tying Weekend

27th to 28th March 2004
Rouen Maritime Museum, Rouen, France
Contact Graham macLachlan
Email: igktfrance@club-internet.fr

German Meeting & Exhibition

7th to 9th May 2004
An Exhibition and Display of Ropework on
board the former Merchant Navy Training

Ship "Schulschiff Deutschland" at Bremen-
Veegesack.

Contact: Peter Willems
email: peter@fancyworks.de

EVENTS

The Beale Park Boat Show

11th to 13th June 2004
Members of the Guild will be in attendance
Beale Park, Lower Basildon, Pangbourne,
Nr Reading, Berkshire
Contact: Ken Nelson
Tel: 0783 6722198

SECRETARY:

Nigel Harding
16 Egles Grove,
Uckfield,
Sussex, TN22 2BY
Tel: 01825 760425
E-mail: nigel@nigelharding.demon.co.uk

Guild Annual Subscription rates:

Juniors £5
Seniors £16
Families £20

Corporate by arrangement

Payable by cash/cheque Eurocard, Master-
card or Visa. Taxpayers in UK - we would pre-
fer a covenanted subscription.

EDITOR:

Colin Grundy
c/o 16 Egles Grove,
Uckfield,
Sussex, TN22 2BY
Tel: 0794 6841157
E-mail: knotting_matters@btinternet.com

Advertising Rates:

	Members	Non-members
Full page	£32	£49
Half page	£19	£22
Quarter Page	£10	£15

Guild Supplies

Price List 2003

Item	Price
Geoffrey Budworth	
Notlore <i>a miscellany of quotes from fact and fiction</i>	£2.50
The Knot Book	£3.99
Plaited Moebius Bands	£2.50
Knot Rhymes and Reasons	£1.50
Brian Field	
Breastplate Designs	£2.50
Concerning Crosses	£1.50
Eric Franklin	
Turksheads the Traditional Way	£1.50 *
Nylon Novelties	£2.00 *
Stuart Grainger	
Knotcraft	£3.60 *
Ropfolk	£1.30 *
Turks Head Alternatives	£2.20 *
Creative Ropecraft (Hardback - 3rd Ed.)	£9.95
Knotted Fabrics Hardback <i>price includes UK postage</i>	£9.00
John Halifax	
Something Different <i>with over 50 Button Knots</i>	£3.20
Colin Jones	
The DIY Book of Fenders	£9.95
Harold Scott	
On Various Cruxiform Turks Heads	£2.50
Sliding Template Method for Designing Cruciform Turks-Heads Vol. 2	£3.00
Skip Pennock	
Decorative Woven Flat Knots	£12.50*
IGKT	
Knotted Matters copies of past editions	£2.50
(Some past editions available - contact the Secretary for details)	
*bulk purchases of these items available at a discount - phone for details	
Cheques payable to IGKT, or simply send your credit card details	

