

# CONTENTS

---

## 1. BRICK PROPERTIES

1.1 Defining Masonry Units	05
1.2 Brick Dimensions	06
1.3 Brick Strength	07
1.4 Durability	08
1.5 Expansion	10
1.6 Efflorescence	11
1.7 Lime Pitting	12
1.8 Solar Absorptance & Reflectance	13
1.9 Cold Water Absorption	14
1.10 Colour Variation	15

## 2. WORKING WITH BRICKS

2.1 Brick Bonds	17
2.2 Decorative Brick Patterns	18
2.3 Blending	19
2.4 Mortar Joints	20
2.5 Mortar	21
2.6 Best Bricklaying Practices	24
- Guidelines for Laying Bowral Dry-pressed bricks	25
- Guidelines for Laying Designa Basalt bricks	26
- Armaclay Building Guidelines (Available in WA ONLY)	27
- Verticore Building Standards (Available in WA ONLY)	28
2.7 Brick Storage	29

## 3. CLEANING & MAINTENANCE

3.1 Brick Cleaning and Maintenance	31
- Preventative Care is the First Step	
- Cleaning Your Brickwork	
- Removing Common Stains	
3.2 Cleaning Mortar stains with Hydrochloric Acid	33
3.3 Hand vs High Pressure	34
3.4 Efflorescence	35
3.5 Calcium staining/Scum (Insoluble white deposits)	36
3.6 Iron Stains	37
3.7 Vanadium Stains	38
3.8 Bowral Chillingham White Cleaning Instructions	39
3.9 Bowral Bricks Cleaning Instructions	40
3.10 San Selmol Bricks Cleaning Instructions	41

## 4. FIRE RESISTANCE & SOUND RATING

4.1 Fire Resistance	43
- Structural Adequacy	
- Integrity	
- Insulation	44
4.2 Sound Rating	45
- Acoustic Properties	
- Construction Details to Achieve Maximum Performance	46
4.3 National Construction Code (NCC) Requirements and Deemed to Satisfy Walls	47
- NCC Requirements	
- Requirements for New South Wales, Victoria, South Australia, Tasmania and Western Australia	48
- Requirements for Queensland and The Northern Territory	49
- Achieving the Required Acoustic Performance	50
4.4 Sound Rating of NSW Common Bricks	51
4.5 WA Utility Bricks	55

## 5. DESIGN CONSIDERATIONS

5.1 Design for Durability	56
- General	
- Masonry Units	57
- Mortar	60
- Ties, Connectors and Lintels	
- Reinforcement	
5.2 Robustness of Brickwork	61
- Design Principles	
- Limiting Dimensions for Robustness	62
5.3 Design to Avoid Cracking	65
- General	
- Locations of Articulation Joints	
- Detailing of Articulation Joints	67
- Control Joints	
5.4 Design Considerations of Designa Basalt	68
5.5 Armabeam Clay Brick Lintels (Available in WA only)	76
5.6 Brick Estimator	77
5.7 Brick Coursing Heights	78
5.8 Brick Gauge	79
- 230mm bricks	79
- 290mm bricks	80
- 470mm bricks	81
- Armaclay/Verticore Brick	82
- Face Block	83
- Peninsula brick	84

# BRICK TECHNICAL MANUAL

Brickworks Building Products is one of Australia's largest and most diverse building material manufacturers. Under the Brickworks Building Products umbrella are some of Australia's best known building materials brands including Austral Bricks, Bowral Bricks, Daniel Robertson and Nubrik. With manufacturing and sales facilities across Australia, Brickworks Building Products is uniquely placed to service the demands of the building industry.

The technical information in this manual is aimed to provide guidance on the properties of bricks and on the selection of bricks for specific applications. Brickworks Building Products manufactures all products to Australian Standard AS/NZS 4455 (Masonry units and segmental pavers), unless otherwise specified in the technical data sheet made available for each product. Australian Standard AS/NZS 4456 (Masonry units and segmental pavers - methods of test) outlines the test methods required for the determination of the brick properties discussed.

General information about bricklaying practices has also been provided to briefly explain some aspects of masonry construction.

The following sources are available for more detailed information:

Think Brick Australia

Australian Standards relevant to masonry

The Building Code of Australia

#### DISCLAIMER

All information contained in this publication was believed to be correct at the time of collation. Brickworks Building Products takes no responsibility for any errors or omissions. Users of this document are advised to make their own decision as to the suitability of this information for their situation.

# BRICK PROPERTIES

 australbricks®



BORAL BRICKS







nubrik  
authentic brickwork

# 1.1 Defining Masonry Units

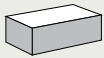
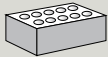
According to AS/NZS 4455.1 Part 1, masonry units are defined in the following manner:

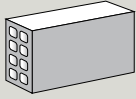
**Table 1** – Graphical representation and physical guidelines for masonry unit descriptions

Type of Unit	Description
 <b>a) Solid unit</b>	A unit that contains recesses no greater than 10% of its gross volume and is intended to be laid with full bed joints
 <b>b) Cored unit</b>	A unit with cores, intended to be laid with its cores vertical and with full bed joints
 <b>c) Hollow unit</b>	A unit with a void percentage higher than 70%, intended to be laid with its cores vertical and with face-shell-bedded joints bed joints
 <b>d) Horizontally cored unit</b>	A unit with cores, intended to be laid with its cores horizontal and with full bed joints
 <b>e) Special purpose unit</b>	A unit that does not fall within the parameters of the above

For further information, see section 1.4.12 of the standard

# 1.2 Brick Dimensions

## 1.2.1 Dimensional Category

The dimensions of the brick are determined and classified through the cumulative measurement of 20 units in accordance with AS/NZS 4456.3.

Then depending on their deviation from the declared work size and the method by which compliance to a specification is determined, masonry units are divided into five categories: DW0, DW1, DW2, DW3 and DW4, where DW stands for dimensional deviations for walling units. The relevant tolerances for each of these categories are shown in Table 1.

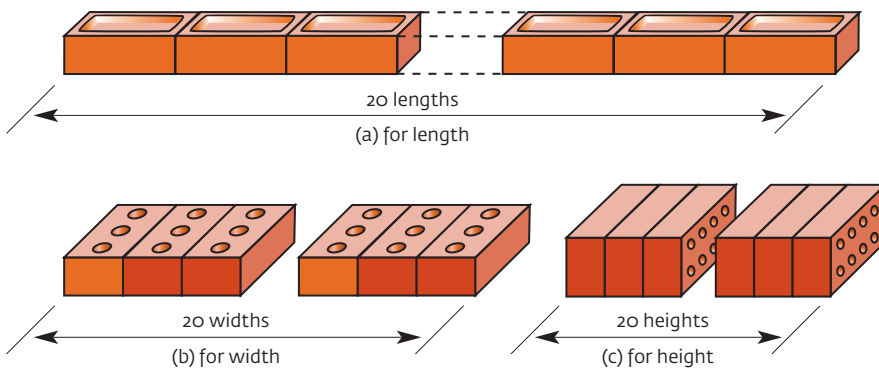

Figure 1 – Measuring cumulative dimensions

Table 2 – Dimensional deviations of masonry units, categories and definitions in accordance with AS/NZS 4456.3 (Sourced from Think Brick Australia Industry Reference Guide 5th Edition).

Category	Work size dimensions (mm)		
	Under 150mm (for example, width and height)	150 to 250mm (for example, length)	Over 250mm (for example, length of modular bricks and blocks)
DW0	No requirement		
DW1	± 50	± 90	± 100
DW2	± 40	± 60	± 70
DW3	By agreement between supplier and purchaser		
DW4	Standard deviation of not more than 2mm and the difference between the mean and the work size of not more than 3mm		

Note: DW4 can only be determined from the individual dimensions of 20 units (Method B of AS/NZS 4456.3)

# 1.3 Brick Strength

## Characteristic unconfined compressive strength ( $f'_{uc}$ )

The  $f'_{uc}$  values are determined using the test method detailed in AS/NZS 4456.4 and is expressed in MPa (Mega Pascal). The test method involves subjecting the masonry unit to increasing load by compressing it between two metal platens in a compression testing machine.

It is impractical to test every unit in a consignment, and usually a very small number of samples in relation to the large number of units it represents, are tested. For these reasons, the standard is based on the 95% characteristic value at a 75% confidence

level. This means that there is a 75% certainty that the strength of 95% of the units in the lot is higher than the characteristic strength determined from testing the samples.

An aspect ratio (height-to-thickness ratio) factor is also incorporated to compensate for the frictional effects experienced between the unit and the platens which prevents the sideways spread of the unit as shown in figure 2. This allows the results to be converted to an equivalent unconfined compressive strength value ( $f'_{uc}$ ) independent of the dimensions of the unit. This strength value allows direct comparison of all masonry units, regardless of the size.

The characteristic unconfined compressive strength ( $f'_{uc}$ ) values now supplied for a traditional sized brick are approximately 60% of the previously used characteristic confined compressive strength values. It is important to note that this difference is due to the altered approach used when determining the values and not a reduction in strength.

Refer to section 3 of Think Brick Australia Manual 2: *The Properties of Clay Masonry Units* for further information on compressive strength measurements.

Figure 2 – Compressive Strength of Masonry Units

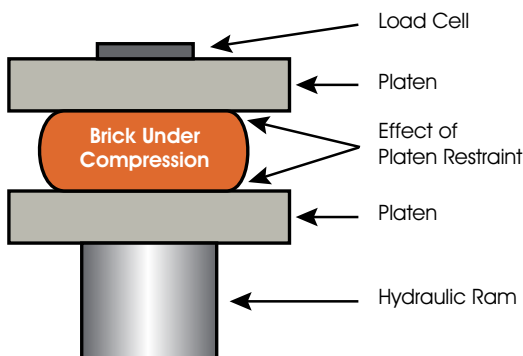

# 1.4 Durability

## Salt Attack

The durability of a brick is a measure of its resistance to attack by soluble salts. The test method used to determine the durability of bricks is given in AS/NZS 4456.10. The suitability of the units for use in a given environment determines their salt attack resistance category. The National Construction Code (NCC) defines the environment with three exposure classifications for brick:

### 1. Exposure Grade (EXP)

Suitable for use in external walls exposed to aggressive environments, such as:

- in areas where walls are subjected to salts in the soil, adjacent material or ground water,
- in coastal areas where walls are exposed to attack from windborne salt spray, or
- retaining walls that may be subjected to fertilisers and ground salts.

In environments where exposure grade masonry is necessary, the minimum mortar classification required is M4 (refer to the section on mortar). In addition, exposure grade bricks may not be suitable for use in areas subject to cyclic freezing and thawing. For more information on the suitability of products contact Austral's Technical Department.

### 2. General Purpose (GP)

Suitable for use in an external wall under ordinary exposure conditions.

### 3. Protected (PRO)

Suitable for use in internal and external walls only when above a sheet or membrane damp-proof course and protected by an adequate coping, eaves, roof or similar top covering. These units should not be directly exposed to saline environments.

The ability of a unit to resist salt attack may be categorised either by past experience of the product demonstrating resistance to a saline or severe marine environment, or by testing in accordance with AS/NZS 4456.10.

- Exposure Grade is survival of 40 cycles
- General Purpose is survival of 15-40 cycles
- Protected is less than 15 cycles of the immersion test in sodium chloride and/or sodium sulphate, as described in AS/NZS 4456.10.

## Durability Required

The severity of the environmental conditions, such as the amount of moisture and the availability of soluble salts, determines the durability grade required. The NCC states that masonry units must be classified and used in the exposure conditions appropriate to their classification. Australian Standard AS 3700 provides details of these classifications. The durability requirements set out in AS 3700 are summarised in the following table:

**Table 3 – Exposure Classifications**

Exposure Classifications			
Exposure	Minimum Salt Attack Resistance Grade of Masonry Units	Minimum Mortar Classification	Minimum Durability Classification of Built-in Components
Severe Marine Environment (EXP)	Exposure	M4	R4
Marine Environment (GP)	General Purpose	M3	R3
Below Damp Proof Course in Aggressive Soils (EXP)	Exposure	M4	R4

AS 3700 classifies a marine environment as:

- 1km to 10km from a surf coast, or
- 100m to 1km from a non-surf coast.

AS 3700 classifies a severe marine environment as:

- within 1km of a surf coast, or
- within 100m of a non-surf coast.

It is important to take into consideration the given environment during the design and construction of brickwork buildings, to minimise the potential for salt attack. The most suitable mortar joints for aggressive environments are ironed or weather struck joints. The mortar classifications given in the table and the types of mortar joints possible are discussed in more detail in the mortar section of this manual. It should also be noted that raked mortar joints should not be used in severe marine environments.

The minimum durability classification of built-in components is particularly relevant to the use of wall ties in masonry constructions. AS/NZS 2699.1 classifies the durability of masonry wall ties as:

- R3 - galvanised to a coating weight of at least 470g/m<sup>2</sup> on both sides, in accordance with AS/NZS 4680
- R4 - stainless steel grade AS 1449/316 or AS 1449/316L

Think Brick Australia Manual 2, *Section 3, The Properties of Clay Masonry Units* provides further information on the durability of bricks.



### Fretting of Brickwork (Salt Attack)

Fretting of brickwork is linked to the durability of bricks and directly related to the exposure environment in which they are placed. The fretting (flaking or crumbling) of bricks can be prevented by the adequate maintenance of the wall structure. An extreme case of fretting is shown below.

Fretting is caused by the action of salt migration in the walling system. Water which has salt dissolved in it migrates through the brick to the brick surface. As the brick dries, the salt is left behind and forms a salt crystal. The salt crystals grow in the voids within the brick. As more salt is left behind by the evaporation of water, the salt crystal grows larger and larger. The strength of the growing salt crystal can be stronger than the elements that hold the brick together. If this occurs, the brick face begins to crumble and fall away. This is also the case for mortar joints.

For salt attack to occur the following three conditions are required:

- there must be presence of salts
- water ingress
- evaporation of salt water

The absence of any of these conditions will prevent salt attack. The fretting of bricks can be exacerbated at specific locations around a house, which undergo increased wetting and drying cycles. The brickwork will continue to deteriorate unless moisture movement through the masonry is prevented.

When treating fretting, "prevention is the best cure". The source of the salt may be airborne salt from sea spray or salts that are naturally present in the soil, or introduced by fertilizers and salt-water swimming pools. The use of bore water may also provide the source of the salt.

The first step in treating fretting is to identify the source of the salt and where the salt might be coming from. The best method of preventing fretting is to prevent the salt from being absorbed into the wall. This may be a physical barrier such as plastic sheeting, digging the soil away from the wall or rearranging the sprinklers so that they do not spray directly onto the wall.

Once fretting has begun it will not stop until the salt source is identified and removed. It could then take another 12-24 months before the fretting process comes to a complete halt. Once the fretting process has stopped the brickwork can then be repaired. Any repairs made to the brickwork while the fretting action is still occurring will generally fail.

Fretting brickwork may be treated using breathable sealers that penetrate the brickwork and consolidate loose particles. However, depending on the degree of fretting it may be necessary to replace the affected brickwork.



Figure 3 – Effect of salt attack on brickwork

# 1.5 Expansion

## Brick Growth

Bricks undergo long-term permanent expansion over time. This expansion continues for the life of the brick, but the majority of the growth occurs early in its life. Most bricks have a coefficient of expansion in the range of 0.5-1.5mm/m (millimetres per metre) over fifteen years. Designers can use the values of the coefficient of expansion to accommodate for the growth of bricks by the size and spacing of the control joints.

The coefficient of expansion, or e-factor value, of clay bricks is tested in accordance with AS/NZS 4456.11 and is an estimate of the amount of growth expected in the first fifteen years after the brick leaves the kiln. Typical values are given only as a guide as:

- there is no pattern in the coefficient of expansion based on brick colour or manufacturing methods, and
- the coefficient of expansion can vary considerably between batches even within a single brick type, due to variations in the manufacturing process and raw materials used.

## Control Gaps

The provision of control gaps or articulation joints between parts of the structure during construction will accommodate movements within the structure over time. Numerous sources of movement exist and include:

- The change in size of building materials with temperature, loading conditions and moisture content
- The differential change in size of building materials (for example, cement products shrink over time, whilst clay bricks expand slowly over time)
- Foundation and footings movement
- Frame movement
- Frame shortening
- Temperature movement
- Internal horizontal and vertical movement

## Design of Control Gaps

Typical control gaps should initially be about 20mm wide, clear of mortar dags or bridges, tied at appropriate intervals with flexible ties and sealed with a polyethylene rod or suitable compressible filler. The filler material should be positioned well back from the masonry surface to avoid the filler material becoming visible if the joint contracts.

## Common Problems

The typical problems arising with expansion gaps include:

- Inadequate sealing
- Failure to ensure that the gaps are clean and that no hard materials such as mortar droppings are left before sealing
- The use of joint fillers that are too rigid, which have compressive strengths high enough to transfer forces across the joint.

However, these problems can be avoided by good workmanship during construction. Further information on expansion gaps is available in our Design Considerations section.

# 1.6 Efflorescence

Efflorescence is defined by salts left on the surface of units after evaporation of water. The surface deposits can be either loose crystalline salts or amorphous films which can be a result of small amounts of soluble salts. These salts are sulphates of calcium, magnesium, aluminium, sodium, and potassium.

Chlorides are almost non-existent, but in some instances carbonates of calcium, sodium and potassium may appear.

The method of testing for efflorescence given in AS/NZS 4456.6 classifies the unit as one of the categories in the table below.

**Table 4** – Potential to efflorescence, categories and definitions in accordance with AS/NZS 4456.6.

Category	Definition
Nil	No observable efflorescence
Slight	No more than 10 percent of any surface of the specimen covered by a thin deposit of salt
Moderate	More than 10% of one surface but not more than 50% of the total specimen surface covered by a thin deposit of salt
Heavy	A deposit of salt covering more than 50 percent of the total brick surface
Severe	Any efflorescence that is accompanied by powdering and/or flaking of the surface of the specimen



**Figure 4** – Brickwork effected by efflorescence

# 1.7 Lime Pitting

Lime pitting is an imperfection occurring in the surface of a brick due to the expansion of large lime particles just below the surface. The lime originates from the raw materials used in the manufacture of the bricks.

Lime pitting is observed when the lime particles are present just below or on the surface of the brick. The volume expansion of the lime particle, resulting from the presence of moisture, can cause it to pop out of the brick or break the brick surface, generating a defect. An example of a large lime pit is shown in the figure below:



**Figure 5** – Lime pitting appearing on the face of the brick

Lime pitting is defined in AS/NZS 4456.0 and the degree of lime pitting can be determined in accordance with AS/NZS 4456.13. Lime pitting is classified by the number and size of lime pits on the face or ends of the brick, as described below.

**Table 5** – Lime Pitting Classifications

Nil	No Visible lime pits
Slight	Not more than 5 lime pits, none exceeding 8mm in diameter
Moderate	No pits exceeding 10mm diameter
Severe	Pit or pits in excess of 10mm diameter

# 1.8 Solar Absorptance & Reflectance

In the design of energy efficient buildings, it is important to be able to calculate the heat loss or gain of materials used to construct these buildings. To do so, the solar absorptances of all products were found in order to obtain a measure of the solar energy efficiency of each product.

Solar absorptance is an indication of the amount of solar energy or heat that passes into a material, compared to the amount that is reflected from the material. Solar absorptance relies on colour, no matter what material you use. Dark materials have a higher solar absorptance and will absorb more solar energy. Choosing lighter coloured bricks and roof tiles will reduce the amount of heat energy entering into your home, leading to lower energy bills and increased thermal comfort.

Austral Bricks has classified all wall colours as light, medium or dark on the basis of their solar absorptance and they are summarised in the table below. These classifications can be used in energy efficiency verification software, such as NatHERS.

Solar reflectance is the inverse of solar absorptance and is a measure of a materials ability to bounce back solar energy, that is, to reflect light. A lighter colour will have higher heat reflection than a darker one, but it will not necessarily produce more glare or light reflection. It is possible to get a surface with low solar absorptance and low light reflection.

These categories are used by both the NCC and Building Sustainability Index (BASIX) with slightly different scales. These are summarized in the table below.

**Table 6** – Solar Absorptance Index for the BCA and BASIX scales.

Scale	Classification of Solar Absorptance Index (0 – 1)		
	Light	Medium	Dark
BCA	<0.4	0.4 – 0.6	>0.6
BASIX	<0.475	0.475 – 0.7	>0.7

# 1.9 Cold Water Absorption

The amount of water a masonry unit can absorb is measured by the cold water absorption test. This is calculated in accordance with AS/NZS 4456.14 whereby the unit is submerged in water for 24 hours and the subsequent amount of water that is absorbed is calculated as a percentage of the original weight of the unit.

## Initial rate of absorption

The initial rate of absorption (IRA) is a function of the size and extent of the porosity of the bricks. The IRA is a measure of how quickly a brick will absorb water. The test method IRA is given in AS/NZS 4456.17 *Determining Initial Rate of Absorption (suction)*.

## Determining initial rate of absorption (Suction)

The ability of bricks to absorb water affects the bond formed between brick and mortar. A tug-of-war occurs between the bricks ability to absorb water and the capacity of the mortar to retain water. If either the brick or the mortar wins, a poor bond will result. Therefore, the water retentivity of the mortar needs to be matched to the IRA of the bricks to ensure that a strong bond forms.

## High Suction Bricks

If the brick wins the tug-of-war and the water is absorbed too quickly from the mortar, the cement will not undergo proper hydration. Therefore, if the bricks have high suction the mortar will stiffen in the bed joint before the next course can be properly bedded. To accommodate high suction bricks, a high water retention mortar is required. It may also be necessary to wet the bricks prior to laying, in order to reduce their suction. However, wetting the bricks may lead to efflorescence in the brickwork. Dry press bricks often have high suction. Dry press bricks can be lightly sprayed with a hose and left until the water has spread throughout the brick before laying.

## Low Suction Bricks

If the mortar wins the tug-of-war and retains too much water, the bricks will tend to float on the mortar bed. Low suction bricks may, therefore, make it difficult to lay plumb walls at a reasonable rate. To accommodate for low suction bricks a leaner mortar is required. A lean mortar can usually be obtained by increasing the proportion of washed sand to unwashed sand used in the mix.

For further information on the absorption of water by bricks refer to section 3 of the Think Brick Australia Manual 2, *The Properties of Clay Masonry*.



## 1.10 Colour Variation

Our clay bricks and pavers are made from naturally occurring minerals that are kiln fired to lock in their colour and strength for life. The composition of the raw materials as well as the firing process may cause each manufacturing run to differ. The resulting colour and texture variation is inherent in the process and part of the appeal of our natural products.

The product images in our brochures and on our website give a general indication of colour for your preliminary selection. We recommend you also view current product samples and look at actual finished projects before making your final selection.

Please view our sample walls in our display centres. They are a general indication of the product with the normal amount of blend variation.

# WORKING WITH BRICKS

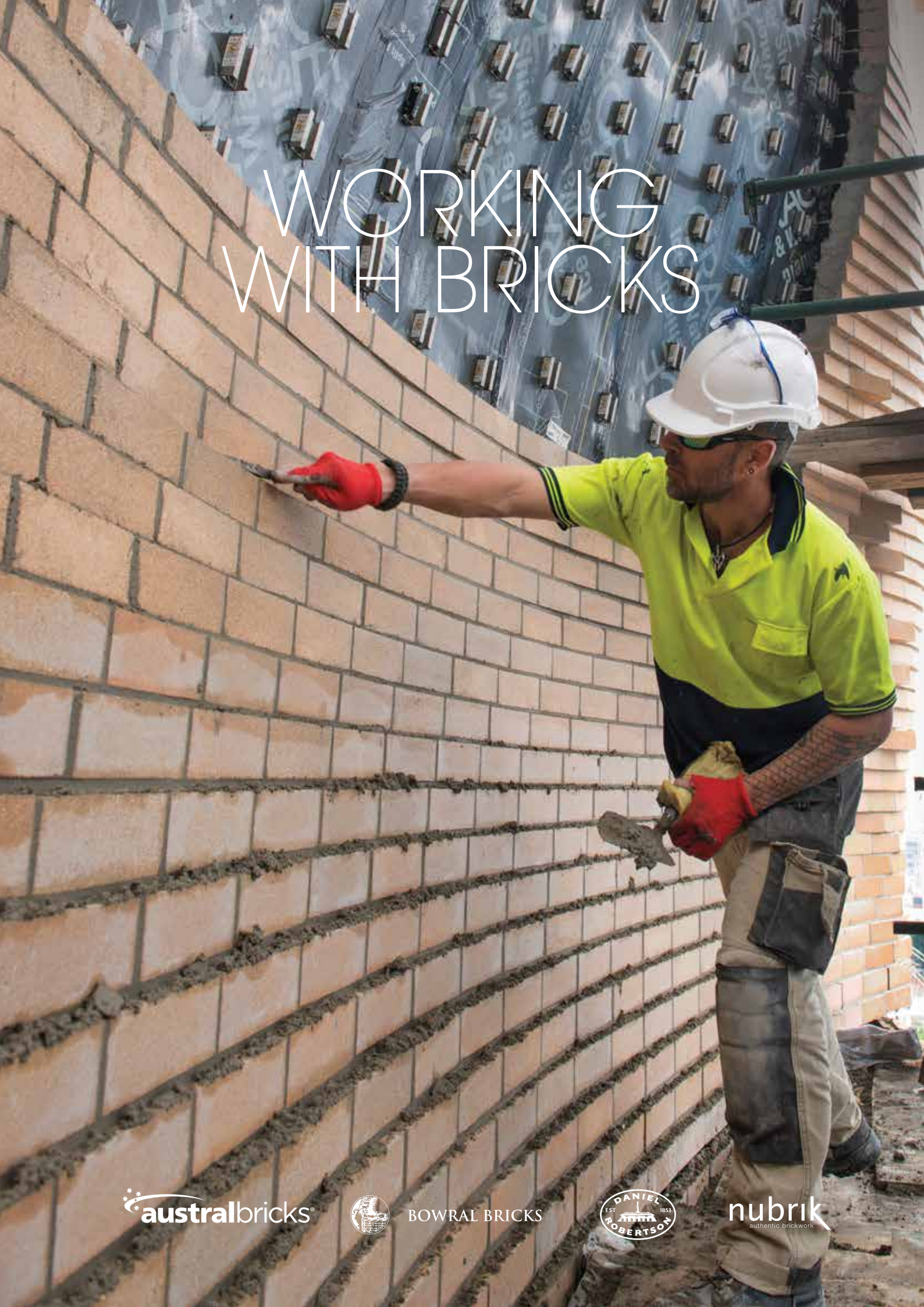



## 2.1 Brick Bonds

A bond refers to the pattern in which bricks are laid. The most common bond used in construction is Stretcher Bond which provides the most effective bond strength for your brick wall and it complies with AS 3700. For other bonding patterns, structural integrity of the brickwork must be confirmed with a structural engineer.

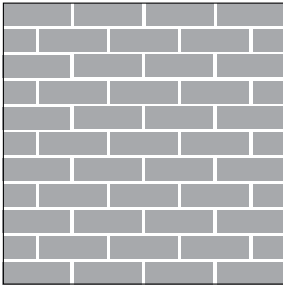

Stretcher Bond

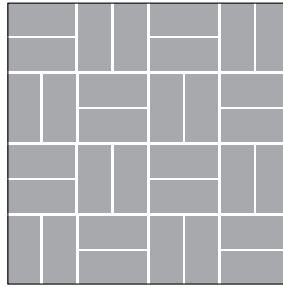

Weave Bond

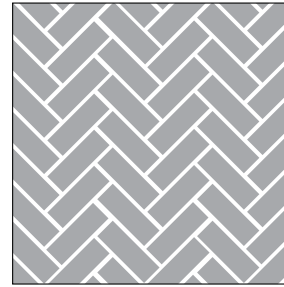

Herringbone Bond

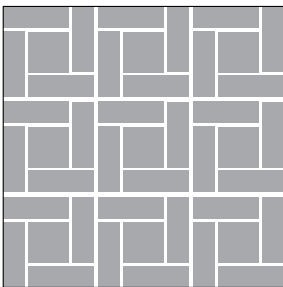

Knit Bond

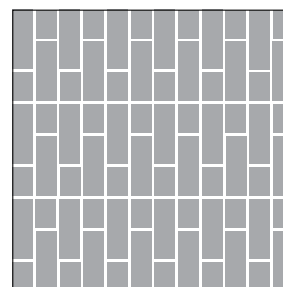

Stitch Bond

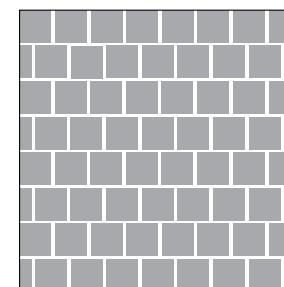

Stagger Bond

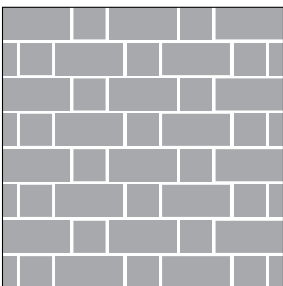

Flemish Bond

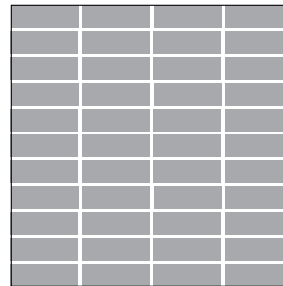

Stack Bond

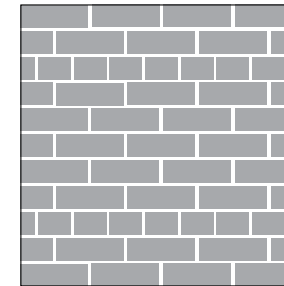

Common Bond (Full Headers every 6th course)

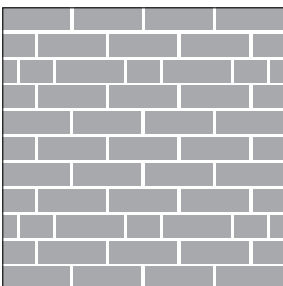

Common Bond (Flemish every 6th course)

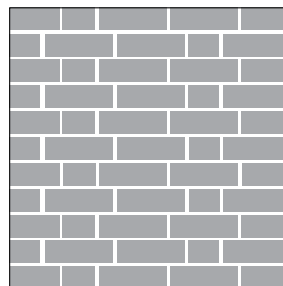

Garden Wall Bond

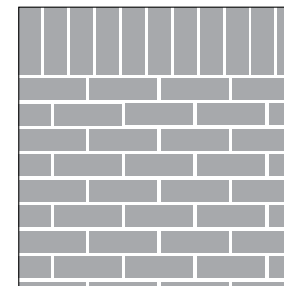

Soldier Course with Stretcher Bond

## 2.2 Decorative Brick Patterns

Bricks are such a versatile material, they truly allow you to express your life and style in so many ways. Below are examples of brick patterns that can be used to differentiate your project. Structural integrity of the brickwork must be confirmed with a structural engineer for these brick patterns.

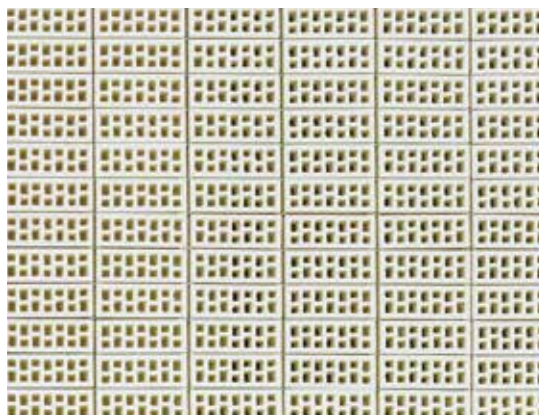
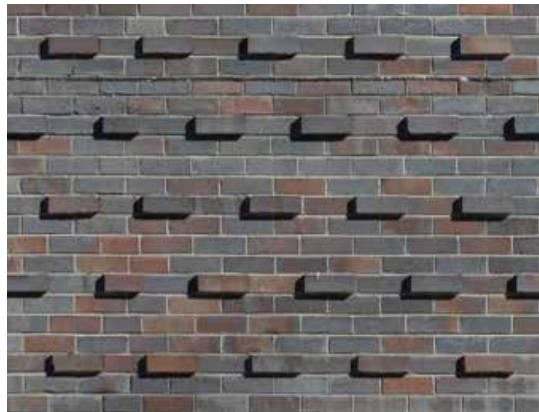
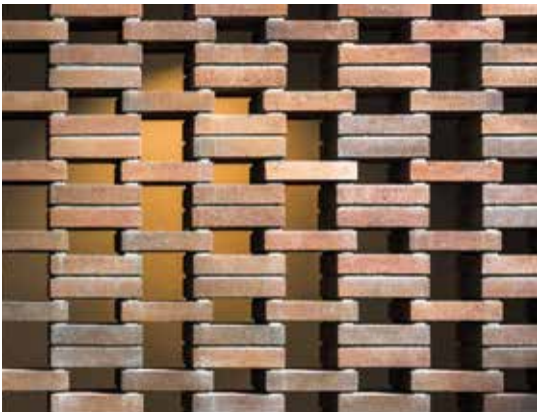

## 2.3 Blending

The composition of the raw materials as well as the firing process will result in colour variation not only within packs, but also from pack to pack. This variation is inherent in the process and part of the appeal of our natural products.

To ensure that colour variation from one pack to the next is dealt with correctly, we advise that the bricks are blended (mixed among themselves) during laying. The advised method to do this is to select units from down and across three to six open packs to ensure an even colour distribution across the surface.

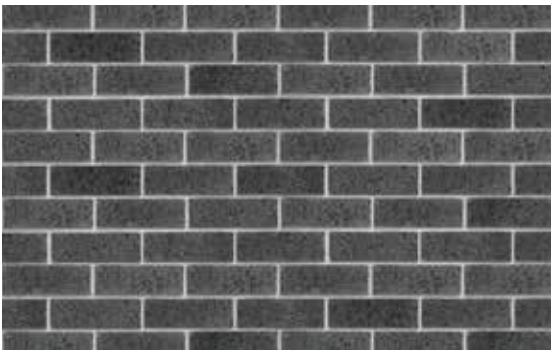

**Figure 1** – Well blended

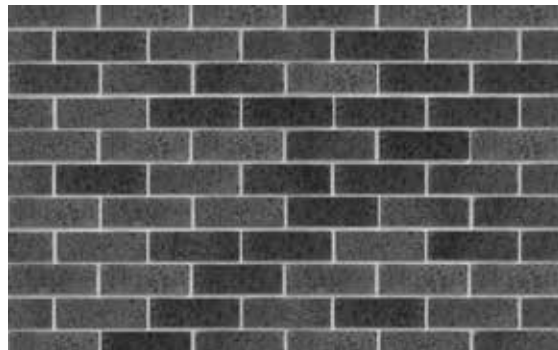

**Figure 2** – Poorly blended

## 2.4 Mortar Joints

Mortar joint style also plays a major part in determining the overall appearance of a building. The different styles possible are shown below.

Properly filled and tooled joints improve the durability, weather proofness and sound performance of brickwork. Raked and ironed joints are used to achieve the 'character' look in a new home. Flush joints will increase the impact of the mortar colour

when a contrasting colour is chosen. For bricks with a bevelled edge, it is recommended that a raked joint be used.

It should be noted that raked or recessed joints should not be used in severe marine environments and should be avoided in applications where durability is critical.

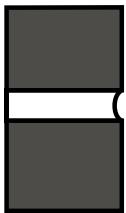

Shallow Ironed (Rolled)

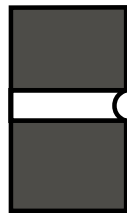

Deep Ironed (Rolled)



Struck Flush

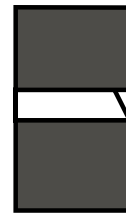

Weather Struck

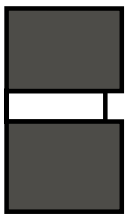

Raked

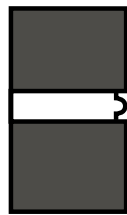

Beaded Pointing

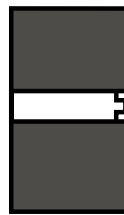

Tuck Pointing

### Joint thickness and tolerances

The standard thickness for a mortar joint is 10 mm. However joints must vary in thickness to allow for the natural size variation of clay bricks. AS 3700 allows a deviation from the specified thickness of bed joint of  $\pm 3$  mm.

The minimum thickness of the perpend must not be less than 5 mm, while the allowable deviation from the specified thickness of a perpend is  $\pm 5$  mm.

## 2.5 Mortar

### Mortar colour

The mortar is no longer just a functional element. Today, the choice of mortar colour and style is just as important as the choice of brick. Mortar generally represents about 15% of the total visible area of brickwork and can dramatically change the look of a building. For example, mortar coloured to match the brick wall will give the impression of a large area of one colour. Whereas, contrasting mortar colour will highlight the shape of individual bricks.

Mortar can be coloured, usually by adding powdered or liquid pigments to the mortar as it is mixed by the bricklayer. All colours should be confirmed with the bricklayer before a decision is made. Mortar can also be tinted to match the brick colour, giving a very even wall colour. All colours should be confirmed with the bricklayer before a decision is made.

### Examples of some mortar colours



Figure 3 – Off White\*



Figure 4 – Grey\*

### Examples of same brick with different mortar colours



Figure 5 – Off White\*



Figure 6 – Grey\*

\* Colours shown are an indication only. Mortar colours will vary depending on the type of cement, sand and pigments used.

## Mortar Mixes

Mortar mixes are always specified as the proportion of cement to lime to sand. For example, a common mortar made from Portland cement has one part cement, to one part lime and 6 parts of sand is abbreviated C1:L1:S6 or 1:1:6 (the chief cementing agent will always be expressed as one).

The type of mortar mix is classified according to the Australian Standard AS 3700 as M1, M2, M3 or M4. The grade chosen by the masonry designer should match the requirements of the design.

AS 3700 lists the deemed-to-satisfy proportions for the various grades. A brief description of the various mixes is given in the table below.

For a more detailed description of the masonry mixes, grades and their applications refer to AS 3700 or to the Think Brick Manual 10; *Construction Guidelines for Clay Masonry*.

**Table 1** – Mortar mixes always expressed as the proportion of cement to lime to sand. (eg: 1:0:4)

Grade	C : L : S	Application
M4	1:0:4	This cement mortar is very durable and is often specified to contain lime for added workability that may otherwise be very poor. In severe marine environments or below DPC in aggressive soils and saline water M4 mortar must be used with bricks of Exposure Grade.
M4	1:0.25:3 1:0.5:4.5	These are the strongest and least permeable composition mortars. In severe marine environments or below DPC in aggressive soils and saline water M4 mortar must be used with bricks of Exposure Grade. Because of its high durability this is the preferred mortar for producing fade-resistant pigmented mortar.
M3	1:1:6	This is the common general-purpose mortar found in most specifications and can be used in all areas except where an M4 mortar is required. It is usually specified when the properties of the brick to be used are unknown. This mortar suits the majority of building applications and brick types.
M2	1:2:9	This lime-rich composition mortar is most suitable for internal brickwork, brickwork above a damp-proof course and with General Purpose bricks when used in cottage construction in non-marine environments. This is a forgiving mortar with a good balance between strength, flexibility and permeability. It is not suitable for colouring with pigments as it is prone to apparent fading. This is the preferred mortar for fireplaces and barbecues.
M1	0:1:3	This is a straight lime mortar that sets slowly. It develops very little early strength. This mortar can only be used when repairing historic masonry originally built using lime mortar. In most cases a 1:3:12 mortar is preferable.
M1	1:3:12	This mortar has most of the flexibility of straight lime mortar and can be used for restoration and matching existing construction only.

## Mixes for Different Mortar Colours

Table 2 shows the components required to give the best colour results in M3 mortar, compliant to AS 3700/4773.

Weathering and cleaning can adversely affect the colour of the mortar. Pigmented mortars must be strong enough to retain the pigment particles on the face of the joint. In weak mortars, the pigment particles may be rapidly eroded from the face of the joint by wind and rain.

Acid cleaning of brickwork may also degrade pigment colour, leading to faded, patchy and unattractive mortar joints. For durable pigmented mortar always finish the joint by tooling even when a raked joint is required.

**Table 2** – Mortar ingredients

Black	6 parts white or yellow brick sand 1 part General Purpose cement 1 part lime Black mortar oxide - volume according to directions on the packet
Cream	6 parts yellow brick sand 1 part off white cement 1 part lime
Natural	6 parts yellow brick sand 1 part General Purpose cement 1 part lime
Off White	6 parts white brick sand 1 part off white cement 1 part lime
Red	6 parts white or yellow brick sand 1 part off white cement 1 part lime Red mortar oxide - volume according to directions on the packet

## Batching Mortar

Unless the proportions of sand, lime and cement that go into a mortar mix are measured with care, it is impossible to be sure if the correct mix has been achieved. In order to ensure that the correct proportion of materials has been used it is suggested that batching be carried out using buckets. A shovel should not be used as the measure during batching, as a shovel is able to hold more sand than cement (as shown in the images below).



**Figure 7** – Cement



**Figure 8** – Sand

## Other Mortar Components

### *The Importance of Lime*

The addition of lime to mortar has the advantage of making the mortar workable in the wet state and may eliminate the need for plasticiser admixtures. Mortar containing lime will be less pervious, more durable and more 'forgiving' than a mortar without lime. There is no substitute for the benefits of lime.

### *Admixtures*

The additives permitted by Australian standards (AS 3700) include:

- Plasticisers or workability agents, including air entraining agents complying with AS 1478
- Cellulose type chemical water thickeners
- Colouring pigments complying with BS EN 12878 (a British standard)
- Set-retarding chemical agents complying with AS 1478
- Bonding polymers

Other admixtures cannot be used unless they have demonstrated compliance with AS 3700.

## 2.6 Best Bricklaying Practices

### Wall Ties

Wall ties are used to connect the leaves of a cavity wall or to connect a masonry wall to a timber frame or steel stud. The failure of wall ties may result in the masonry falling during an earthquake or in high winds.

It is essential that the wall ties are chosen for the design requirements, as specified in AS/NZS 2699. The durability requirements of AS 3700 (as previously discussed in the durability section) should also be met when selecting the wall ties. For example, the classification R4 needs to be met by the wall ties in severe marine environments. In addition, the installation of the wall ties is critical to the integrity of the system.

The wall ties should be:

- installed at the correct embedment distance and strength in the mortar,
- aligned correctly to prevent water transfer into the building, and
- placed at the required spacings.

Horizontal and vertical spacing of wall ties should not exceed 600mm, whilst features such as openings, control joints and wall edges generally require spacings of less than 300mm. The spacing of the wall ties relies on the individual design. AS 3700 should be referred to for more details on the design and installation of wall ties. A more detailed description of placement of wall ties is available in Think Brick Australia Manual 10, *Construction Guidelines for Clay Masonry*.

### Damp-Proof Courses (DPC) & Flashings

AS 3700 requires that damp-proof courses and flashing be used to prevent the movement of moisture vertically in the masonry and from the exterior of the building to the interior. In addition, the moisture from a cavity should be shed to the outer course by the flashings.

It is important that the DPC should not be bridged, thereby allowing moisture to travel above the DPC level. The DPC should be exposed out of the face of the brickwork to prevent any moisture paths up the brickwork.

Care should also be taken during the application of a render coating, to prevent the formation of a bridge. The DPC should also be considered during exterior landscaping.

### Weep Hole(s)

A weep hole acts as a drain hole through the brick wall. Weep holes are created during the construction of the brick wall. Weep holes are normally in the first or second brick course above ground level.

Weep holes are required at the head and sill flashing of windows over 1200mm wide and are commonly used for smaller windows also.

### Prevention of Brickwork Stains

Good workmanship and correct storage of bricks during construction will ensure that a number of potential stains are avoided. In addition, the use of the correct cleaning methods will prevent further problems arising. It is also important that garden beds, paved, concrete or tiled areas should be below the level of the installed DPC and that they do not cover the weepholes in your brickwork.

Building any form of structure over your weepholes can restrict the drainage of moisture that penetrates through your brickwork. Allowing moisture to enter the brickwork may result in efflorescence issues.



### 2.6.1 Guidelines for Laying Bowral Dry-Pressed Bricks

These guidelines are to provide a best practice guide to laying Bowral dry-pressed bricks, which, when followed will reduce common problems.

#### **Blending bricks**

Blend the bricks by stripping the pack vertically rather than horizontally, as well as between a minimum of 6 packs to create an even mottle.

#### **Do not soak bricks prior to laying.**

The brick pack can be lightly sprayed and allowed to dry initially to reduce the suction of the brick but saturating the brick will lead to staining problems.

#### **Adjust the mortar consistency to match the brick.**

The mortar for dry pressed bricks needs to be softer than for extruded bricks as the brick will absorb some of the moisture from the mortar quite quickly and reduce the time available for adjustment.

#### **Do not make the mix harder than necessary.**

If M3 mortar is required do not make M4 mortar. It is harder to clean later.

#### **Do not put clay into the mortar.**

This does not come off the walls and does not dissolve in hydrochloric acid. It makes cleaning very difficult. 'Brickies Sand' is a good mixture of clay and sand.

#### **Fill the perp joints.**

It makes a stronger wall and stops water penetration.

#### **Dry brush the wall at breaks during the day and before completing work at the end of the day.**

Reducing the excess mortar from the brick wall before it goes hard reduces the amount and duration of both acid and cleaning that needs to be done later.

#### **Do not sponge the walls.**

Using a sponge may smear mortar across the face of the brick which can react with the acid during the acid cleaning process and lead to problems.

#### **Storage**

Ensure bricks are stored appropriately (either on pallets or on plastic sheeting), to prevent bricks absorbing ground salts and excessive water, which may cause issues when laid.

#### **Copings, Sills, Weathering**

Stormwater should be shed so as to clear the masonry immediately below. Copings and sills should project at least 10 mm beyond the wall face at the underside of the sill or coping. Where downpipes have not been installed water from the guttering should be diverted away from the brickwork.

#### **Laying Recommendations**

1. Do not soak bricks prior to laying. The brick pack can be lightly sprayed and allowed to dry initially to reduce the suction of the brick but saturating the brick will lead to problems.
2. Adjust the mortar consistency to match the brick. The mortar for dry pressed bricks needs to be softer than for extruded bricks as the brick will absorb moisture from the mortar quite quickly and reduce the time available for adjustment.
3. Do not make the mix harder than necessary. If M3 mortar is required don't make M4 mortar - it will only be more difficult to clean off later.
4. Do not use clayey sand in the mortar. This will be extremely difficult to clean off.
5. Properly fill the perp joints. It makes a stronger wall and reduces excessive water penetration.
6. Cover the top of the wall when rain is expected and until eaves/roofing or coping is installed to prevent excessive water penetration.
7. Clean the job as you go to avoid the need for using hydrochloric acid later. Take more care than normal to ensure no smears or dags of mortar are left to dry on the brickwork. If the use of hydrochloric acid is required to clean mortar from dirty brickwork a lot more work will then be required to remove the resulting vanadium stains.

## 2.6.2 Guidelines for Laying Designa Basalt Bricks

These guidelines are to provide a best practice guide to laying Designa Basalt bricks, which, when followed will reduce common problems.

### Compliance

Austral Bricks Designa Basalt is a natural stone product for use as an external cladding or as an internal walling material. Designa Basalt is manufactured to AS/NZS 4455.1. As such, Designa Basalt is a masonry material that complies with the performance requirements of the National Construction Code, NCC, Volume 2 Clause 3.3.1 unreinforced masonry when designed and constructed in accordance with AS 3700.

Designa Basalt meets the requirements of NCC Clause 3.3.4 weatherproofing of masonry when designed and constructed in accordance with AS 3700. This is based on the service history of masonry in cavity or veneer construction with a drained and vented cavity.

### Laying Designa Basalt

Designa Basalt is to be constructed to AS 3700 and the following should be adhered to:

- Designa Basalt bricks shall be full bedded.
- Mortar shall comply with AS 3700 Table 11.1 and be of M4 classification.
- Mortar joints should be 10mm +/- 2mm.

- Masonry wall ties shall comply with AS 2699.1
- Face fixed ties are to be screw fixed. Side fixed ties can be screw or nail fixed.
- Damp courses, weep holes, lintels should be installed in the same way as standard brickwork.
- During installation, use clean water and brush to promptly remove any fresh mortar that splashes onto the brickwork.

### Designa Basalt Mortar

Designa Basalt needs to be laid with a bonding polymer addition to the mortar. The acrylic additive is combined with water, in the ratio specified by the manufacturer, and added to the mortar mix. Lanko 752 Bondit is a suitable bonding polymer (Davco Construction Materials [www.davco.com.au](http://www.davco.com.au)).

### Cleaning

Being a natural stone, care should be taken to ensure a minimal amount of mortar gets on the face of the bricks, and all the mortar haze should be thoroughly removed during the initial installation process.

It is recommended that strong acids such as hydrochloric acid (HCl) are NOT used, as this could create an irreversible reaction in the stone.



### 2.6.3 Armaclay Building Guidelines

Only available in Western Australia

#### Construction and Application

- Armaclay is not suitable for external applications.
- Armaclay can be used for internal walls and for the inner leaves of external cavity walls in full brick construction above floor level.
- Armaclay is suitable for use in single-storey or the uppermost storey of multi-storey house construction within the geometric limits of AS4055: "Wind Loads for Housing".
- All internal surfaces should be hard plastered or cement rendered.
- Armaclay meets the requirements of AS/NZS4455: "Masonry Units and Segmental Pavers".
- All construction should comply generally with AS3700: "Masonry Structures".

#### Wall Sizes

- The maximum height of internal walls is 2.7m. See National Construction Code.
- The lengths of external cavity walls please review Verticore – Building Standards

#### Joints

- All corners must have filled perpend; Gable walls and party walls must have filled perpend.
- Top and bottom courses must have filled perpend; Walls over windows and doors must have filled perpend.
- All perpend joints should be filled when sound and fire ratings are a consideration.
- The widths of any unfilled perpend must not be greater than 12mm but may be zero.

#### Wall Ties

All wall ties shall meet the requirements of AS2699.1: "Built-in Components for Masonry Construction - Wall ties" and conform in anchorage and embedment to the requirements of AS3700. Wall ties for cavity walls should be spaced as follows:

- For N1 wind category, light-duty ties at 450mm horizontally and 600mm vertically.
- For N2 wind category, light duty ties at 300mm horizontally and 600mm vertically or medium duty ties at 600mm horizontally and 600mm vertically.
- For N3 wind category, medium duty ties at 450mm horizontally and 600mm vertically.

Austral Bricks recommends intersections must be keyed with units engaged every second course. If ties are used as an alternative they must be medium duty wall ties every second course and the gaps must be filled with mortar.

#### Mortar

Mortar must comply with AS3700: and the following:

- M2 (1:2:9) or better for internal walls above the damp-proof course and fully enclosed within the building.
- For other locations, as required by AS3700: Table 5.1.
- Chasing should be kept to a minimum and where walls are chased on both sides, the chases must not be made in the same units.

**Austral Bricks recommends that a Structural Engineer be consulted before construction of any building commences.**

## 2.6.4 Verticore Building Standards

Only available in Western Australia

### Construction and Application

- Verticore is suitable for use in single-storey or two-storey house construction within the geometric limits of AS4055: "Wind Loads for Housing".
- Verticore can be used for internal walls, external walls and for cavity walls in full brick construction.
- Verticore is suitable for use in areas where the design wind category as stipulated in AS4055 is N1, N2 or N3.

- All internal surfaces should be hard plastered or cement rendered.
- Verticore meets the requirements of AS/NZS4455: "Masonry Units and Segmental Pavers".
- All construction should comply generally with AS3700: "Masonry Structures".

### Wall Sizes

- The maximum height of internal walls is 2.7m. See National Construction Code.
- The lengths of external walls up to 2.7m high must not be greater than the following shown in Table 8:

**Table 3** – Maximum external wall lengths up to 2.7m high.

Wind Category	Walls with four sides supported and no opening	Walls with four sides supported and an opening	Walls with a free end or control joint
N1	9.8m	4.3m	4.9m
N2	7.3m	3.1m	3.7m
N3	5.4m	1.7m	2.7m

### Joints

- All corners must have filled perpend; Gable walls and party walls must have filled perpend.
- Top and bottom courses must have filled perpend; Walls over windows and doors must have filled perpend.
- All perpend joints should be filled when sound and fire ratings are a consideration.
- The widths of any unfilled perpend must not be greater than 12mm but may be zero.

Austral Bricks recommends intersections must be keyed with units engaged every second course. If ties are used as an alternative they must be medium duty wall ties every second course and the gaps must be filled with mortar.

### Mortar

Mortar must comply with AS3700 and the following:

- M2 (1:2:9) or better for internal walls above the damp-proof course and fully enclosed within the building.
- M3 (1:1:6) or better for external walls, including below the damp-proof course in non-aggressive soils and in marine environments more than 100mm from a non-surf coast and more than 1km from a surf coast.
- For other locations, as required by AS3700: Table 5.1.
- Chasing should be kept to a minimum where walls are chased on both sides, the chases must not be made in the same units.

### Wall Ties

All wall ties shall meet the requirements of AS2699.1: 2000, "Built-in Components for Masonry Construction - Wall ties" and conform in anchorage and embedment to the requirements of AS3700: 2001. Wall ties for cavity walls should be spaced as follows:

- For N1 wind category, light-duty ties at 450mm horizontally and 600mm vertically.
- For N2 wind category, light duty ties at 300mm horizontally and 600mm vertically or medium duty ties at 600mm horizontally and 600mm vertically.
- For N3 wind category, medium duty ties at 450mm horizontally and 600mm vertically.

**Austral Bricks recommends that a Structural Engineer be consulted before construction of any building commences.**

## 2.7 Brick Storage

The storage of bricks is very important, as it can directly affect the performance of the product.

### Tips for good storage:

1. Place brick packs on plastic or timber when possible. Avoid placing brick packs directly on the ground where they can absorb dirty or saline ground water.
2. Don't stack bricks in water puddles on concrete slabs. Concrete, especially fresh concrete, can leach calcium salts that may be absorbed by the bricks, and contribute to early age efflorescence of the bricks or brickwork.
3. Keep bricks dry by either covering them or leaving the plastic wrap they are delivered in on until they are to be used.
4. Attempt to keep bricks from becoming too hot as this may cause the mortar to dry too quickly.
5. Plan your brick delivery. Place the packs as close as possible to where the bricks are to be laid. Try to avoid too much handling of bricks on site – this increases efficiency and reduces the risk of damage to the bricks before being laid. Wherever possible group three or four packs to allow product to be blended down and across the packs simultaneously.



Figure 9 – Example of poor brick storage

# BRICK CLEANING & MAINTENANCE



BOWRAL BRICKS



nubrik®  
authentic brickwork

# 3.1 Brick Cleaning and Maintenance

Our clay bricks are made from naturally occurring minerals that are kiln fired to lock in their beauty and strength for life. Not only is brick the sturdiest building material, it is also the easiest and most economical to maintain. The following guidelines provide you with some essential information to ensure that your brickwork maintains its beautiful appearance well into the future.

## 3.1.1 Preventative Care is the First Step

Gardens add natural beauty to any home, however it is essential that garden beds, paved, concreted or tiled areas are below the level of the installed damp proof membrane and do not cover the weep holes in your brickwork.

Building any form of structure over your weep holes can allow termites to infiltrate your barrier or restrict the drainage of moisture that penetrates your brickwork.

## 3.1.2 Cleaning Your Brickwork

### Brick Properties

The appearance of a brick building can be permanently spoilt by bad cleaning techniques or by the use of the wrong cleaning agent. For this reason, it is important to ensure that the correct cleaning methods are utilised for the best results and to help reduce the associated problems with brick cleaning.

It is important to remember, that the services of a professional cleaner should be sought if a stain is too large or too difficult to remove.

### Safety Precautions

Some chemicals used during cleaning are highly corrosive (some are classified as S6 poisons). The manufacturer's instructions and safety precautions should always be followed when using acids and other proprietary cleaning chemicals. The few points below should be followed to avoid serious personal injury:

- Always wear protective clothing and protective equipment such as gloves, safety glasses, etc.
- Do NOT use high pressure cleaners to apply cleaning chemicals as it is dangerous to the operator and to those nearby.

### Step 1: Identify the type of stain

Make sure you know the type of stain you are trying to remove to ensure you are using the most effective cleaning method.

### Step 2: Select the correct cleaning method

Once you have identified the stain, you can use the cleaning methods described on the following page to remove it.

### Step 3: Follow the procedures

Follow the written instructions as well as those shown on the labels of proprietary cleaners. Always clean a small test area first to ensure the cleaning method has worked to your satisfaction.

### Step 4: Safety precautions are essential

Make sure you read safety precautions thoroughly, wear protective clothing and store any chemicals safely.

**Note:** *Hydrochloric Acid is commonly used to clean mortar stains from brickwork when it is initially laid. It does not need to be used at any other time during the life of your brickwork. If used incorrectly it can cause unsightly staining that is extremely difficult to remove.*

## 3.1.3 Removing Common Stains

### Adhesive tape

**Remedy:** Wipe with petrol, lighter fluid or paint stripper.

### Blood

**Remedy:** Wet the stain with water then cover it with an even layer of sodium peroxide powder. Sprinkle with water or cover with a water soaked bandage and leave for five minutes. Scrub vigorously with clean water and then neutralise using a five percent solution of acetic acid (vinegar) and rinse with water at end of treatment.

### Coffee stains

**Remedy:** Apply a cloth that has been saturated in a solution of one part glycerin to four parts water. When the stain is drawn into the cloth, rinse with water.

### Egg

**Remedy:** Wipe the stained area with acetone until the stain is removed.

### Ink and Biro

Different inks require different treatments.

**Remedy:** Wipe with white spirits, acetone or apply an acetone poultice to help draw out the stain.

#### **Marker pens**

**Remedy:** Wipe off with acetone or a poultice of acetone and talc.

#### **Oil, grease and animal fats**

**Remedy:** Apply an engine degreaser emulsifier or a strong detergent, then rinse well.

#### **Organic growths / fungus, mould and moss**

Porous masonry provides a benign environment for organic growth when it is continuously moist, especially in light but shady conditions and when there are plenty of nutrients available. You will need to check downpipes, flashings etc for ways to stop continuous moist conditions. If brickwork dries, organic growth should not occur.

**Remedy:** Treat with diluted sodium hypochlorite bleach with a small amount of liquid detergent. Liquid chlorine, Exitmould and White King are suitable for this application. Clean with hot water and detergent. Repeat as necessary.

#### **Soils**

**Remedy:** Mix a strong detergent solution of one cup detergent to five litres hot water. Scrub and rinse well.

#### **Paint and graffiti**

These can be difficult stains to remove, particularly if they have aged. Therefore, it is best to treat them when fresh.

#### **Wax Crayon**

**Remedy:** Wax crayon can usually be removed with acetone. It should be applied with a rag or tissue on smooth surfaces or with a small brush on textured surfaces. If it tends to spread, try using a poultice and brush off when dry.

#### **Acrylic Paint**

**Remedy:** A commercial paint remover should be used.

#### **Oil based paints or enamels**

**Remedy:** Burn off and follow with scraping and wire brushing.

#### **Fresh Aerosol Paint**

**Remedy:** A commercial paint remover should be used.

#### **Dried paint**

**Remedy:** Flood the stained area for a few minutes with a paint remover eg. methylene dichloride. Scrub to loosen the paint film. Flush with water to wash away the loosened paint. Scrub with scouring powder until the stain is removed. Flush with water.

**Note:** Specialty propriety graffiti removal products are also available.

**It is important to remember, that should a stain be too large or too difficult to remove, then the services of a professional cleaner should be sought.**

#### **Bitumen and Tar**

Scrape off the excess material and scrub the surface with scouring powder and water. Chilling the surface with ice or solid carbon dioxide (dry ice) can assist removal. These stains usually need two treatments with a commercial emulsifying agent (or degreaser). First, mix the emulsifier with kerosene to remove the stain. Then clean the kerosene off, with emulsifier mixed only with water.

#### **Soot and Smoke**

**Remedy:** Minor stains can be removed with sugar soap. Mix 500g sugar soap with 2 litres of hot water and apply liberally with a brush. After stains disappear, scrub with a mixture of detergent and a household scouring powder containing sodium hypochlorite.

For stubborn stains treat the area with undiluted sodium hypochlorite for 10 minutes before scrubbing and hosing.

A poultice of sodium hypochlorite solution in an inert base (such as diatomaceous earth) could be used for severely affected areas. The poultice should be left for 1 to 2 days before scrubbing and removing.

#### **Timber Stains**

**Remedy:** Avoid leaving timber resting against the brickwork as the tannin may leach from the timber and cause staining. Wipe timber stains off with a solution of 120 grams oxalic acid per 4 litres of hot water. Neutralise the wall after this treatment.



## 3.2 Cleaning mortar stains with Hydrochloric Acid

Hydrochloric acid is only used to remove mortar stains from clay brickwork. Generally, hydrochloric acid should not be used to treat any other stains or at any other time during the life of your brickwork. If used incorrectly, it can cause unsightly staining that is more difficult to remove.

In particular, care should be taken to treat any vanadium stains prior to cleaning with hydrochloric acid. It is very important that protective clothing be worn and that the safety and chemical storage precautions necessary for working with hydrochloric acid are followed.

The following procedure is recommended when cleaning with hydrochloric acid:

1. All mortar dags should be removed using either a metal or wooden scraper. This should be done 24-36 hours after completion of the brickwork.
2. Protect all areas which may come in contact with the cleaning agent as recommended by the manufacturer of the proprietary cleaner. Special care should be taken with window frames, aluminium dampcourses and gutters.
3. Saturate the area of brickwork to be cleaned and all adjacent areas below with water.
4. Use the correct ratio of hydrochloric acid and water:
  - **Light coloured bricks - 1 part hydrochloric acid to 20 parts water**
  - **Dark coloured bricks - 1 part hydrochloric acid to 10 parts water**
  - **Under no circumstances should more than 1 part hydrochloric acid to 10 parts water be used. It is better to scrub more vigorously than to use more acid.**
5. When cleaning, try not to work in direct sunlight.
6. Always begin at the highest point and work down the wall.
7. Only clean small areas at a time, for example one square metre, so as to allow adequate time to wash off the cleaning solution, to ensure no staining occurs.
8. Allow solution to remain on wall for 3-6 minutes before scrubbing. Be sure not to scrub the joints.
9. Rinse thoroughly, making sure all cleaning solution has been removed.

**Note:** *light coloured bricks should be rinsed with a neutralising solution, such as bicarbonate of soda or washing soda, instead of water.*

**Note:** *Bricks manufactured in Queensland, especially light-coloured bricks, may be more susceptible to acid burn, due to large amounts of iron oxide present in the raw materials. The following ratio could be substituted into Step 4 when acid cleaning these bricks: 1 part hydrochloric acid, 1 part phosphoric acid and 10 parts water. Contact Austral's local technical department for further details.*

Further details of the recommended cleaning procedure and the various techniques used are available in the Think Brick Australia Manual 3 *Cleaning of Clay Masonry Guide 2014*.

### Cleaning Internal Brickwork

Extra care should be taken when using hydrochloric acid to clean mortar stains on internal masonry. Acid fumes produced during cleaning should be ventilated adequately. The likelihood that the acid fumes will persist into the period of occupation can be reduced by:

- Cleaning the internal masonry early in the construction period, thereby allowing the walls to be rinsed sufficiently
- Ensuring adequate ventilation apply a neutralising solution to the wall.



## 3.3 Hand Vs High Pressure

### Hand Cleaning

Hand cleaning is appropriate for small jobs or for when the use of a high pressure water jet is likely to cause damage. Dry press bricks should be generally cleaned by hand. The following procedure should be followed:

1. Allow mortar to harden (clean 24-36 hours after completion of masonry work) and remove any large mortar particles with hand tools.
2. Protect adjacent materials as recommended by the manufacturer of the proprietary cleaner.
3. Saturate the wall with clean water. Never let the wall dry out during cleaning; work on small areas.
4. Test a small unseen section prior to full-scale cleaning.
5. Apply the acid solution (as described previously) to the wall using a brush or spray.
6. Allow solution to remain on wall for 3-6 minutes before scrubbing vigorously.
7. Rinse thoroughly as small areas are cleaned.

### High Pressure Water Jet Cleaning

High pressure water jet cleaning can be used on clay masonry, but precautions must be taken so that the bricks and the mortar joints are not damaged by the process. The following procedure should be followed:

1. Allow to mortar to harden (must be older than 3 days) and remove any large mortar dags with appropriate hand tools
2. Protect adjacent materials as recommended by the manufacturer of the proprietary cleaner.
3. Saturate the wall with clean water. Never let the wall dry out during cleaning; work on small areas.

4. Test a small unseen section prior to full-scale cleaning.
5. Apply acid solution (as described previously) by hand

**Applying chemicals with high pressure cleaners is dangerous and is NOT recommended for safe and successful cleaning.**

6. Wash the wall with high-pressure water after allowing the solution to remain on the wall for 3-6 minutes. When operating the equipment ensure to:
  - **Keep pressure low - maximum 7000kPa (approximately 1000psi)**
  - **Use a wide fan spray nozzle (15°)**
  - **Operate the nozzle at generally 500mm from the wall or never closer than 300mm**
  - Use 'runs' of approximately 1m in width and double clean to ensure the best clean
  - Keep the gun moving constantly or surface abrasion in one spot will result

**Warning:** *If the mortar joints or the bricks are being damaged, either the pressure is too high or the water jet is too close to the wall.*

*It is strongly recommended that a test area should be used to check the impact of the high pressure cleaning on the bricks and mortar. **High pressure cleaning is NOT recommended for dry press bricks** and increased care should be taken with slurry coated bricks. Examples of the damage that can be caused by high pressure cleaning dry press bricks are shown below.*



**Figure 1** – Dry press brick damage due to high pressure cleaning

**Figure 2** – Damage resulting from the use of a turbo head

## 3.4 Efflorescence

Efflorescence is a powdery deposit of salts which forms on the surface of bricks and mortar. It is usually white but efflorescence can be yellow, green or brown. A temporary efflorescence is particularly common on new brickwork as soluble salts are transported to the surface of the brickwork by water.

Efflorescence can occur from a variety of sources. New bricks contain minimal, if any, soluble salts, but mortar and concrete have relatively high soluble salt contents. Ground waters that are naturally salt-bearing can be drawn into base brickwork. A faulty or bridged damp-proof course will allow the salts to migrate up the wall. Render that has been applied over a damp-proof course can also allow salt to migrate up the face of the brickwork. Water allowed to enter uncovered cavity walls during construction is also likely to cause efflorescence, so brickwork must be protected from water entry during construction.

The amount of efflorescence that occurs is related to the amount of water in the bricks, and their drying time. The more water in the bricks, and the longer it is there, the more chance salts will have to dissolve and be brought to the surface as the bricks dry out.

Efflorescence on new brickwork may be unsightly, but it will not cause damage unless it persists for a long time. Persistent efflorescence should be taken as a warning that water is entering the wall through faulty copings, damp-proof courses or pipes. If allowed to

continue unchecked, the salts carried to the face of the wall may eventually attack the bricks and cause deterioration.

**Remedy:** Laying dry bricks and providing good ventilation to speed up the drying process after the bricks have been laid can minimise efflorescence. Forced ventilation and heating of the premises may be necessary to ensure drying during cold winter months. The best removal method is simply to brush off the deposit with a stiff dry bristle brush after the wall has dried out.

Collect the removed salts with a dust pan or a vacuum cleaner to prevent the salts re-entering the brickwork. Alternatively, an absorbent cloth could be used to sponge down the surface. Use only a small amount of water and rinse the cloth in clean water regularly to remove the salts.

Wetting the wall by methods such as hosing usually dissolves efflorescence back into the brickwork, allowing it to reappear again when the wall dries out. Acid or alkaline treatments are not recommended as they do more harm than good because they add to the total salt content of the wall. The application of kerosene or oil does little or nothing to hide the efflorescent salts and prevents their subsequent removal by brushing and washing.



Figure 3 – Efflorescence on brickwork

## 3.5 Calcium Staining/Scum (Insoluble white deposits)

Insoluble white deposits appear almost as a milky film on the brickwork. The hard white deposits are insoluble in water and are invisible when wet. Do not confuse these deposits with efflorescence, which is soluble in water.

Most commonly this staining can arise from the products of the setting reaction of Portland cement, which are leached out of concrete elements such as sills, lintels, copings, cement render or from insufficiently-dense mortar. They combine with carbon dioxide from the atmosphere to form white deposits that are insoluble in water but soluble in dilute hydrochloric acid.

The combination of clay from the mortar with calcium and silica residues from the cement forms calcium silicate, which could also produce the insoluble white scum. Calcium silicate is highly insoluble in most acids and is white in colour. When wet these calcium deposits are invisible. Kaolin, a clay mineral present in most bricklaying sands, can also form a hard deposit. It is insoluble in most acids except hydrofluoric acid (which is a restricted product).

However, the main cause of these insoluble white deposits is bad cleaning practice; allowing mortar made with sand containing too much clay to remain too long on the surface of the bricks and



**Figure 4** – Insoluble white deposits on brickwork

then removing it with too much acid and/or too little water. Refer to the section on mortar stains within this page for details on the correct method of cleaning with acid.

When not enough water is used before and after the acid wash, the products of the reaction between the acid and the mortar can be absorbed into the face of the bricks instead of being washed off the wall.

**Remedy:** Apply full strength Noskum to stained bricks and allow the solution to stand for four to six minutes if the reaction is not immediate. Scrub vigorously and wash off with plenty of water whilst still scrubbing. There is no guarantee that this will resolve the problem in severe cases, as scum is extremely hard to remove.

## 3.6 Iron Stains

Dark patches (usually yellow to deep brown in colour) of iron oxide staining can occur on the face of the brick or in the mortar joints. Iron stains are more noticeable on light coloured bricks and in the mortar joints of dark coloured bricks.



Figure 5 – Iron Staining on Brick Faces



Figure 6 – Iron Staining in Mortar Joints

Iron staining, also known as 'Acid burn' is caused by the use of an incorrect cleaning procedure when treating mortar stains with hydrochloric acid. The acid reacts with iron oxides in bricks or mortar to cause the stains. Common errors in the cleaning procedure include:

- Insufficient pre-wetting of the wall prior to applying hydrochloric acid
- The application of a acid solution that is too strong
- Insufficient rinsing of the brickwork following cleaning

Staining can also be caused by contact with rusting iron or steel such as lintels, nails and bolts, railings and packaging straps. Regular wetting from bore water used for irrigation and by welding splatter from welding near brickwork may also cause iron staining.

**Remedy:** Acid burn stains can be treated using a solution of phosphoric acid, in the ratio of one part acid to four parts water. The solution should be applied and allowed to stand. The stain will normally disappear in 30 minutes to 24 hours.

The treated area should be washed off and then neutralised. A solution of sodium bicarbonate should be applied to neutralise the area and should not be washed off. Proprietary neutralisers such as Neutrill are also available.

An oxalic acid solution of 20-40 grams per litre of water is another solution that could be used in the place of phosphoric acid. However, the substitution of oxalic acid for phosphoric acid is not commonly performed. After the application of either solution, the area should be neutralised as described previously. Proprietary cleaners, such as Noskum, could also be used to treat iron stains.

Phosphoric acid will bleach any iron oxides used as colouring pigments. For this reason pigmented mortars will fade, so the entire wall will need to be treated to maintain a uniform appearance. Alternatively keep the solution off the mortar.

## 3.7 Vanadium Stains

Vanadium stains are evident by a yellow-green discolouration on the face of a brick resulting from the vanadium salts naturally present in most clay materials used to produce light coloured bricks.

Vanadium stains are not powdery crystalline deposits and cannot be simply brushed off. They are often mistaken for moss or algae, which usually grows in damp areas across the whole face of the bricks and mortar. By contrast vanadium stains (as shown below) appear on dry walls, normally as patches on the brick only. Vanadium is a metallic salt present in most light coloured clays throughout the world. It is present in very small quantities.



**Figure 7** – Vanadium staining on brick face

Vanadium salts are put into solution by excess water migrating through the bricks and are brought to the surface as the bricks dry out. As the water evaporates from the drying bricks the vanadium salts are left on the brick surface. The vanadium salt turns green when it crystallises in an acidic environment, such as after acid cleaning or upon exposure to rainwater (naturally acidic). Vanadium salts are colourless until they are exposed to an acidic environment.

This process can occur whenever the bricks are subjected to excessive water from rain either before or (more often) during the bricklaying process. If vanadium stains are not removed prior to cleaning with hydrochloric acid (for the removal of mortar stains), they may turn a darker colour and be more difficult to remove.

These stains are neither harmful, nor permanent and do not indicate any defect in the product. They are a thin film on the surface of the brick or paver and will weather away with time. However, the removal of the stains can be hastened by chemical treatment.

**Remedy:** Hydrochloric acid should NOT be used, as it will aggravate the problem. There are a number of different methods for removing vanadium stains, including:

- **Method 1:** Spray or brush on sodium hypochlorite (found in household bleach or pool chlorine) onto the stain without wetting the area initially. Allow the solution to stand until the stain disappears and then rinse with water.
- **Method 2:** Apply a solution of oxalic acid (20-40 grams per litre of hot water) to bricks that have not been pre-wetted. Finally, neutralise the acid with a solution of 15 grams per litre of washing soda (or suitable neutraliser). Do not wash off the neutralising agent. Neutralising is very important, as further staining could result if this step is omitted.
- **Method 3:** A solution of potassium or sodium hydroxide (150 grams per litre of water) could also be applied to the stain. Wash off the solution and any white residue formed once the stain has disappeared.

Proprietary cleaners, such as Noskum, could also be used to remove the vanadium stains. Apply Noskum to the dry bricks.

Wash off after the stain disappears and neutralise with a 15 grams per litre solution of washing soda (or suitable neutraliser).

## 3.8 Bowral Chillingham White Cleaning Instructions

This product is very sensitive to vanadium staining, which is not permanent and will appear after exposure to hydrochloric acid or excessive water penetration (refer to pages 16 & 17 of the Think Brick Australia 'Cleaning of Clay Masonry' Manual).

Vanadium salts are naturally occurring in many light coloured bricks and the resulting stains can be best managed as follows:

### Cleaning Instructions

1. Yellow/green stains present on the bricks prior to laying can be treated successfully with sodium hypochlorite which is the active ingredient in household bleach and swimming pool chlorine (a trigger pack of exit mould is a convenient option). Once the stain has disappeared rinse the brick with clean water.
2. Any remaining stains may require a stronger treatment. Use either:
  - a. A mix of 20 to 40 grams of oxalic acid per litre of water (preferably hot) applied to dry bricks, followed by a neutralising solution of 15 grams per litre of Sodium Bicarbonate once the stain has disappeared. The neutralising solution should not be rinsed off.

OR

- b. Mix 150 grams of potassium or sodium hydroxide (caustic soda) per litre of water and apply to the stained bricks. Wash off with clean water once the stain has disappeared.

3. Some mild stains may reappear after more water (rain) on the masonry depending on the amount of salts originally in the brick and the amount already treated. Address these stains using step 1. Similar to typical white efflorescence, these stains will reduce and disappear in time.

\* If hydrochloric acid is to be used, all existing vanadium stains must first be removed using steps 1 and/or 2. If this is not done the hydrochloric can cause mild yellow/green stains to become darker brown or black which will be much more difficult to remove. The wall should be pre-wet with clean water to minimize acid absorption into the body of the brick and the weakest possible solution of acid should be used. Once the bricks are surface dry, follow up with the neutralising solution as per 2(a) above. Any resulting vanadium stains then need to be treated using step 2.

\*\*Test the chemicals removal efficiency and your application technique on a small discrete test area to determine the most suitable treatment to use, prior to use on the entire affected area.



## 3.9 Bowral Bricks Cleaning Instructions

These recommendations are to provide a best practice guide to Bowral Blue dry-pressed bricks during the construction and cleaning processes, which, when followed will reduce common problems.

### **Cleaning Instructions**

The use of the correct cleaning methods will prevent further problems arising.

### **Clean As You Go**

Cleaning as you go is the best method for ensuring good brickwork. Mortar smears are best cleaned when fresh.

### **Safety Precautions**

The manufacturer's instructions and safety precautions should always be followed when using acids and other proprietary cleaning chemicals.

### **Wet the Wall**

The brickwork must be thoroughly wetted before any acid solution is applied and kept wet ahead of the acid application. Work a small area at a time and where possible avoid cleaning in direct sunlight.

The wall should be kept wet to prevent the acid from being absorbed by the brickwork which can cause staining.

### **Acid Concentration**

Hydrochloric acid is used for cleaning mortar smear by dissolving the cement component of the mortar. The recommended maximum strength for Bowral Blue bricks is 1 part acid to 20 parts water.

Hydrochloric acid should not be used for any other cleaning of brickwork and may result in further staining if used inappropriately.

### **Acid Application**

Apply the acid solution for up to 3 to 6 minutes to allow the chemical action to occur.

### **Hose Off**

It is extremely important to thoroughly hose off the wall as the work proceeds. If the acid is left on the wall too long it can be absorbed into the brickwork and may cause staining.

### **High Pressure Cleaning**

If high pressure cleaning is used, the following should be adhered to:

- Low pressure - max 7000kPa (approx 1000psi)
- Use a wide fan spray nozzle (> 15°)
- Distance of 500mm from the wall
- Use 'runs' of approximately 1m in width
- Keep the gun moving constantly
- Turbo head attachments should not be used

**Warning:** If the mortar joints or the bricks are being damaged, either the pressure is too high or the water jet is too close to the wall.





# 3.10 San Selmo Bricks Cleaning Instructions

These recommendations are to provide a best practice guide to San Selmo bricks during the construction and cleaning processes, which, when followed will reduce common problems.

## Cleaning Instructions

The use of the correct cleaning methods will prevent further problems arising.

## Clean As You Go

Cleaning as you go is the best method for ensuring good brickwork. Mortar smears are best cleaned when fresh.

## Safety Precautions

The manufacturer's instructions and safety precautions should always be followed when using acids and other proprietary cleaning chemicals.

## Wet the Wall

The brickwork must be thoroughly wetted before any acid solution is applied and kept wet ahead of the acid application. Work a small area at a time and where possible avoid cleaning in direct sunlight.

The wall should be kept wet to prevent the acid from being absorbed by the brickwork which can cause staining.

## Acid Concentration

Hydrochloric acid is used for cleaning mortar smear by dissolving the cement component of the mortar. The recommended maximum strength for San Selmo bricks is 1 part acid to 20 parts water.

Hydrochloric acid should not be used for any other cleaning of brickwork and may result in further staining if used inappropriately.

## Acid Application

Apply the acid solution for up to 3 to 6 minutes to allow the chemical action to occur.

## Hose Off

It is extremely important to thoroughly hose off the wall as the work proceeds. If the acid is left on the wall too long it can be absorbed into the brickwork and may cause staining.

Neutralise with 40g per litre bi-carb soda after cleaning.

## High Pressure Cleaning

If high pressure cleaning is used, the following should be adhered to:

- Low pressure - max 7000kPa (approx 1000psi)
- Use a wide fan spray nozzle (> 15°)
- Distance of 500mm from the wall
- Keep the gun moving constantly
- Turbo head attachments should not be used

**Warning:** If the mortar joints or the bricks are being damaged, either the pressure is too high or the water jet is too close to the wall. Avoid stiff bristled brushes or metal brushes.



# FIRE RESISTANCE & SOUND RATING



 **australbricks**<sup>®</sup>



**BOWRAL BRICKS**



**nubrik**<sup>®</sup>  
authentic brickwork

# 4.1 Fire Resistance

Fire resistance levels are specified in the National Construction Code (NCC). This system provides an accurate method of predicting the ability of a wall to maintain its strength in a fire and to resist the spread of the fire.



The fire resistance level (FRL) specifies the fire resistance periods (FRP) for structural adequacy, integrity and insulation. These components can be defined as:

- **Structural Adequacy** - The ability of a wall to continue to perform its structural function.
- **Integrity** - The ability of a wall to maintain its continuity and prevent the passage of flames and hot gases through cracks in the wall.
- **Insulation** - The ability of a wall to provide sufficient insulation, such that the side of the wall away from the fire does not exceed a predefined rise in temperature.

The fire resistance level is expressed in minutes and lists the three components in the same order as they are given above. For example, an FRL of 90/90/90 means a minimum fire resistance period of 90 minutes each for structural adequacy, integrity and insulation. FRL's can be determined from AS 3700 or by testing in accordance with AS 1530.4.

The fire resistance level of a wall depends not only on the thickness of the wall but also on its height, length and boundary conditions (i.e. how it is connected to other building elements). For this reason, it is impossible to give a FRL for a particular brick.

## 4.1.1 Structural Adequacy

The fire resistance period for structural adequacy is specific to the wall type and its boundary support conditions. The Think Brick Australia publication, Design Manual 5, *Fire Resistance Levels for Clay Brick Walls* provides charts for determining the structural adequacy of common wall types. The manual allows designers to assess the fire resistance level for a specific wall type and enables the FRP for structural adequacy to be directly read from a series of charts.

## 4.1.2 Integrity

The fire resistance level for integrity is the lesser of the values achieved for structural adequacy and insulation. That is, the required fire resistance for integrity is met if the level is met for structural adequacy and insulation.

### 4.1.3 Insulation

The fire resistance level for insulation is determined by the material thickness of the wall, as shown in the table below. The material thickness is a function of the type of masonry unit. Masonry units are classified as:

**Table 1** – Masonry thickness

Material thickness (mm)	60	90	110	130	160	180
Fire resistance period for insulation (mins)	30	60	90	120	180	240

#### Solid or cored units

If they have voids with a volume of less than 30%. This classification includes units with frogs. The material thickness for a solid or cored unit is the actual thickness of the units in the wall. For example, a 110mm solid or cored brick will give a 90 minutes fire resistance period for insulation, using the table above.

#### Hollow units

If they have voids with a volume greater than 30% The material thickness of a hollow unit is calculated as the net volume of the units divided by the area of the exposed unit. For example, the equivalent material thickness of a brick of dimensions 230mm x 119mm x 110mm containing 35% coring can be calculated as below:

**Table 2** – Material thickness of a hollow unit

Net volume = $230 \times 119 \times 110 \times (100-35)\%$ = 1956955mm <sup>3</sup>
Area of exposed vertical face of the unit = $230 \times 119 = 27370\text{mm}^2$
Equivalent material thickness = $1956955 / 27370$ = 71.5mm

Therefore, the corresponding fire resistance period for insulation is 30 minutes (from the table above). In contrast, a solid or cored unit of the same size has the much higher value of 90 minutes. In addition, the type of wall impacts on the material thickness. For a single leaf wall the material thickness is based upon the type of unit used, as described previously. The material thickness for a cavity wall is equal to the sum of the material thicknesses of the separate leaves.

For example, the FRP for insulation for a cavity wall built with 90mm solid or cored bricks will be 240 minutes as the material thickness is  $2 \times 90\text{mm} = 180\text{mm}$ . Whereas, a single leaf of 90mm solid or cored bricks has a FRP of 60 minutes.

Note: the FRP is 240 minutes for materials with thicknesses over 180mm.

### Chasing and Recesses

Chasing and recesses can affect the fire resistance periods for a wall. Refer to AS3700 or Think Brick Australia, Design Manual 5, *Fire Resistant Levels for Clay Brick Walls* for further details on when chasing and recesses must be considered.

# 4.2 Sound Rating



## 4.2.1 Acoustic Properties

### Sound Transmission Measurements

The NCC requires that building elements have certain levels of insulation from airborne noise and impact sound. The weighted sound reduction index ( $R_w$ ) describes the acoustic performance of a construction system. It is a single number quantity for the airborne sound insulation rating of building elements. As the acoustic performance of a material or construction improves, the higher the  $R_w$  value will be.

$R_w$  ratings are determined by laboratory tests of a specimen of the construction system. The specimen is fixed within a frame to form the wall between two test chambers. A high noise level is generated in one room and the difference in sound level between the source room and the receiver room represents the transmission loss through the test specimen. The measurements are conducted over a range of sound frequencies. The  $R_w$  rating is then determined by comparing the results with reference curves.

Correction factors (C and  $C_{tr}$ ) can be added to  $R_w$  to take into account the characteristics of particular sound spectra and indicate the performance drop of the wall in the corresponding sound frequency range. The factor C relates to mainly mid to high frequency noise, whilst  $C_{tr}$  relates to lower to medium frequency noise. Some typical noises have been grouped by their corresponding correction factor in Table 3.

The weighted sound reduction index is quoted as  $R_w(C, C_{tr})$ . As an example, if a wall is measured as  $R_w 54(-1, -4)$  the value of the index when the lower frequency correction factor ( $C_{tr}$ ) is applied is:

$$R_w + C_{tr} = 54 + (-4) \quad R_w + C_{tr} = 50.$$

In practice, any small gaps and cracks which permit even minor air leakage will provide a means for sound transmission, leading to lower field performance. This degradation should be recognized and an appropriate allowance made when selecting a tested system to achieve a particular  $R_w$  rating when installed.

The sound transmission class (STC) was the method that was used previously to measure acoustic performance. The requirements of the NCC have changed to comply with international regulations and  $R_w$  is now used. The STC was based on different criteria and did not include any correction factors.

**Table 3** – Correction Factors

Correction Factor	Type of Noise Source
<b>C</b>	Living activities (talking, music, radio, TV) Railway traffic at high speeds Highway road traffic (>80km/h) Jet aircraft at short distance High and medium frequency factory noise
<b><math>C_{tr}</math></b>	Urban road traffic Railway traffic at low speeds Propeller driven aircraft Jet aircraft at large distance Low and medium frequency factory noise

#### 4.2.2 Construction Details to Achieve Maximum Performance

For a wall to achieve its optimum acoustic performance, the construction must be solid without gaps through which air, and therefore sound, can pass. Masonry units must be laid with all joints filled solid including those between the masonry and any adjoining construction. Flanking transmission (through unfilled joints and gaps) is the major reason so many wall constructions fail to achieve their tested performance when in the field. Even a very small penetration will dramatically reduce the insulation performance of a wall. This is one reason why it is beneficial to finish masonry wall construction with render, or a cement-based paint. The render or paint acts as a sealant for the porous masonry and also fills any weaknesses in the mortar joints.

Another common sound path occurs at wall junctions such as at floor or ceiling level and also at the intersection with another wall. Larger voids should be solidly backfilled with mortar. However, where this is difficult to carry out successfully, an expanding foam sealant which is non-shrinking, durable and has a long life span, can be injected into the gap.

To maximize the acoustic performance of a masonry wall, it is important to avoid the following:

- gaps and cracks through which sound can pass
- gaps around service penetrations
- poorly sealed doorways
- back-to-back power outlets and cupboards
- chasing for services

# 4.3 National Construction Code (NCC) Requirements and Deemed to Satisfy Walls

## 4.3.1 NCC Requirements

The noise levels received from adjoining premises are dependant upon the level and type of noise generated and the acoustic performance of the construction between the two dwellings. The BCA requires that the  $R_w$  and  $R_w + C_{tr}$  should be determined in accordance with AS/NZS 1276.1 using results from laboratory measurements.

The NCC classifications for acoustic performance are categorized based on the building type.

Class 1 buildings include single dwellings that do not have another dwelling above or below it, such as a stand-alone house or a row of townhouses. Class 2 buildings include buildings that contain two or more sole-occupancy units, such as an apartment unit. Class 3 buildings include residential buildings that contain a number of unrelated persons, such as a guest house or the residential part of a school, hotel, etc. Aged care buildings are classified as Class 9c.

The NCC should be referred to for more detail on these and other classifications.



### 4.3.2 Requirements for New South Wales, Victoria, South Australia, Tasmania and Western Australia

**Note:** These requirements came into effect from the 1st of May, 2004, except for Western Australia where they came into effect from the 1st of May, 2005.

Common walls separating Class 1 buildings are required to have an  $R_w + C_{tr}$  of not less than 50. In addition, the construction must be discontinuous, if the wall separates a habitable room (living room, dining room, bedroom, study and the like) from a wet room (kitchen, bathroom, sanitary compartment or laundry). Discontinuous construction requires:







- A minimum 20mm cavity between two separate leaves
- If required, in masonry walls resilient wall ties such as those provided by Matrix Industries should be used, and
- No mechanical linkage if the leaves are not masonry.

Walls in Class 2 or 3 buildings that separate sole-occupancy units must have an  $R_w + C_{tr}$  of not less than 50. In addition, if the wall separates a habitable room in one sole-occupancy unit from a wet room in another sole-occupancy unit the construction must be discontinuous. The BCA also requires that walls in Class 2 or 3 buildings that separate a sole-occupancy unit from a plant room, lift shaft, stairway, public corridor, public lobby or the like must have an  $R_w$  of not less than 50. If the wall separates the sole-occupancy unit from a plant room or a lift shaft, the construction must be discontinuous.

In Class 9c buildings, walls separating sole-occupancy units must have an  $R_w$  of not less than 45. Walls separating a sole-occupancy unit in a Class 9c building from a kitchen, bathroom (not including an associated ensuite), laundry, plant room or utilities room must have an  $R_w$  of not less than 45. In addition, walls separating a sole-occupancy unit from a laundry or a kitchen must have satisfactory impact sound resistance. A summary of the BCA's requirements is given below.

**Note:** Impact sound insulation is determined by laboratory testing. A 'tapping machine' is set to operate on a horizontal steel plate which rests against the test specimen. The sound transmission through the wall is then measured and normalized using a reference equivalent absorption area. Adequate impact sound insulation is achieved if the performance of the test specimen is equivalent to, or better than, the performance of deemed-to-satisfy construction under the same test conditions.

In addition, the BCA requires that soil and waste pipes in a Class 1, 2 or 3 building must have a minimum  $R_w$  of 40 if adjacent to a habitable room (but not the kitchen). Or, a minimum  $R_w$  of 25 if the pipes are adjacent to a kitchen, bathroom, laundry or the like.

Building Class	Construction	Requirement
Class 1	Habitable - Habitable 	$R_w + C_{tr} \geq 50$
Class 1	Habitable - Wet 	$R_w + C_{tr} \geq 50$ With discontinuous construction
Class 2 or 3	Habitable - Habitable 	$R_w + C_{tr} \geq 50$
Class 2 or 3	Habitable - Wet 	$R_w + C_{tr} \geq 50$ With discontinuous construction
Class 2 or 3	Sole-Occupancy - Public Area 	$R_w \geq 50$ With discontinuous construction (if lift shaft or plant room)
Class 9c	Sole Occupancy Unit - Sole Occupancy Unit 	$R_w \geq 45$
Class 9c	Sole Occupancy - Wet 	$R_w \geq 45$ With satisfactory impact resistance (refer to note) if laundry or kitchen.



### 4.3.3 Requirements for Queensland and the Northern Territory

Common walls separating Class 1 buildings in the Northern Territory or Queensland are required to have an  $R_w$  of not less than 45 if the rooms separated are habitable. Whilst, a separating wall between a habitable room and a wet room is required to have an  $R_w$  of not less than 50, with satisfactory impact resistance.





Walls in Class 2 or 3 buildings in the Northern Territory or in Queensland, that separate sole-occupancy units must have an  $R_w$  of not less than 45. If the wall separates a habitable room in one sole-occupancy unit from a wet room in another sole-occupancy unit the construction must have an  $R_w$  of not less than 50, with satisfactory impact resistance. The BCA also requires that walls in Class 2 or 3 buildings that separate a sole-occupancy unit from a plant room, lift shaft, stairway, public corridor, public lobby or the like must have an  $R_w$  of not less than 45.

Walls separating sole-occupancy units in Class 9c buildings in the Northern Territory or Queensland, must have an  $R_w$  of not less than 45. Walls separating a sole-occupancy unit in a Class 9c building from a kitchen, bathroom (not including an associated ensuite), laundry, plant room or utilities room must have an  $R_w$  of not less than 45. In addition, walls separating a sole-occupancy unit from a laundry or kitchen must have satisfactory impact sound resistance.

A summary of the requirements for the Northern Territory and Queensland is given below.

**Note:** Impact sound insulation is determined by laboratory testing. A 'tapping machine' is set to operate on a horizontal steel plate which rests against the test specimen. The sound transmission through the wall is then measured and normalized using a reference equivalent absorption area. Adequate impact sound insulation is achieved if the performance of the test specimen is equivalent to, or better than, the performance of a cavity brick construction of two leaves of 90mm bricks under the same test conditions.

In addition, the BCA requires that soil and waste pipes in a Class 1, 2 or 3 building must have a minimum  $R_w$  of 45 if adjacent to a habitable room (other than the kitchen). Or, a minimum  $R_w$  of 30 if the pipes are adjacent to a kitchen, bathroom, laundry or the like.

Building Class	Construction	Requirement
Class 1, 2 or 3	Habitable - Habitable 	$R_w \geq 45$
Class 1, 2 or 3		$R_w \geq 50$ With satisfactory impact resistance (refer to note)
Class 2 or 3		$R_w \geq 45$
Class 9c		$R_w \geq 45$
Class 9c		$R_w \geq 45$ With satisfactory impact resistance (refer to note) if laundry or kitchen.

#### 4.3.4 Achieving the Required Acoustic Performance

The performance requirement of the NCC can be satisfied by:

- Building a deemed-to-satisfy wall as specified in the NCC
- Demonstrating compliance by laboratory testing of an exact construction, or
- Demonstrating compliance by performing field testing

The  $R_w$  figures presented in the following examples of deemed to satisfy walls are the lowest bound results. Further details of these walls can be found in the NCC. Walls built of specific clay bricks may have better performance, as indicated by the manufacturer from individual tests.

It is important to recognize that bricks from different manufacturers and manufactured in different plants give different results. To allow for these differences Austral Bricks test each state's products separately.

As such, the results provided by Austral Bricks are specific only to the state in which they were tested and are not transferrable to products manufactured outside that state or to another company's products.

Direct fixing of plasterboard to single skin masonry walls reduces the acoustic performance of the walls. Plasterboard needs to be fixed on resilient mounted furring channels or on a separated stud wall on one side of the wall, to avoid deterioration of the  $R_w$  rating.

Rendering one or both sides of a wall increases the  $R_w$  rating primarily because the render seals the fine pores in the brickwork and eliminates partially filled mortar joints. In addition, a layer of 13mm render increases the mass of the wall thereby increasing the acoustic performance.

The application of a layer of 13mm render to one side of the wall is predicted to give an increase of 1 in the overall  $R_w$  rating of the construction. In a CSIRO technical study, the tested performance was much better than this prediction, which indicates that factors other than just the mass of the structure play a part in the effect of applying a surface finish to a wall.

Once one side of a wall has been rendered, little acoustic benefit will be gained by rendering the other side. This is largely due to the fact that the relative increase in the mass is small compared to the overall mass of the structure and also because the initial benefit of sealing the pores of the brickwork has already been largely achieved by the first layer of render.

For highly porous masonry wall constructions, sealing one side with an application of a cement-based paint will also result in a noticeable increase in acoustic performance.

#### NCC Deemed-To-Satisfy Examples of $R_w + C_{tr} \geq 50$

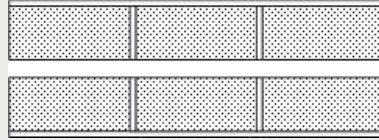

##### Cavity Brickwork

2 leaves of 110mm clay brick masonry with a 50mm cavity and 13mm render on both sides

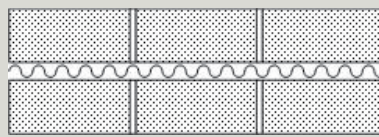

##### Cavity Brickwork

2 leaves of 110mm clay brick masonry with a 50mm cavity and 50mm glass wool or polyester insulation in the cavity

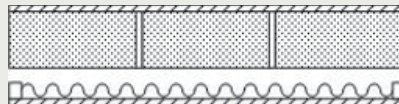

##### Single leaf 110mm Brickwork

Plasterboard directly fixed to one side with a separating stud (70 x 35mm timber stud or 64mm steel stud) at 600 centres spaced 20mm from wall with insulation and plasterboard fixed to the other side

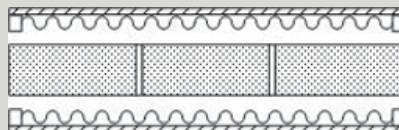

##### Single leaf 110mm Brickwork

Plasterboard directly fixed to one side with a separating stud (70 x 35mm timber stud or 64mm steel stud) at 600 centres spaced 20mm from wall with insulation and plasterboard fixed to the other side

#### BCA Deemed-To-Satisfy Examples of $R_w \geq 50$



##### Cavity Brickwork

2 leaves of 90mm clay brick masonry with a 40mm cavity



##### Single Leaf of 150mm Brickwork

With 13mm cement render on each face

# 4.4 Sound Rating of NSW Common Bricks

## BCA Deemed to Satisfy Walls

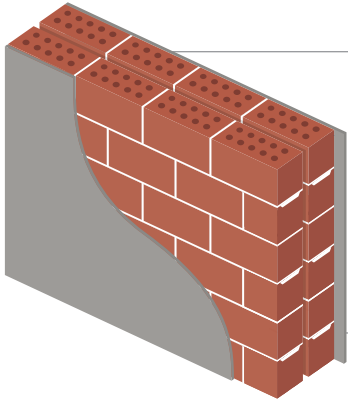

### 110mm

- Cavity wall.
- 50mm cavity.
- 13mm cement render both sides.
- Wall thickness: 296mm.
- Discontinuous construction.

$$R_w + C_{tr} \geq 50$$

## $R_w + C_{tr} \geq 50$ Test Results

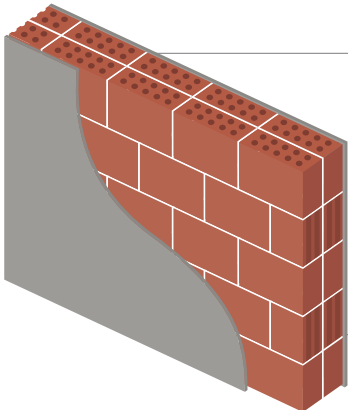

### 90mm - Maxi

- Solid wall.
- 10mm mortar core between two leaves.
- 12mm cement render both sides.
- Wall thickness: 214mm.

$$R_w \text{ 56 (-1;-5)}$$

ATF Report 1609

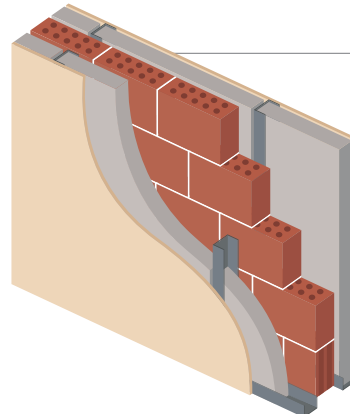

### 90mm - Maxi

- Single skin bricks.
- 13mm plasterboard screw fixed to 64mm Rondo Steel Stud built 15mm from wall with 64mm track top and bottom with insulation both sides.
- Wall thickness: 274mm.
- Discontinuous construction.

$$R_w \text{ 65 (-7;-14)}$$

ATF Report 1131

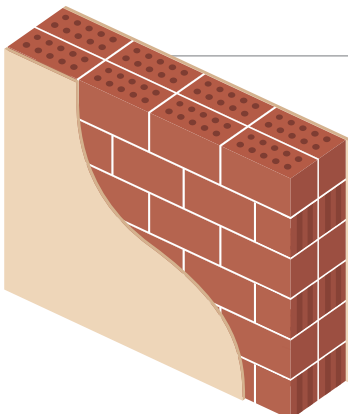

### 110mm - Standard

- Solid wall.
- 10mm mortar core between two leaves.
- 10mm plasterboard directly fixed both sides.
- Wall thickness: 250mm.

$$R_w \text{ 54 (-2;-4)}$$

ATF Report 1612

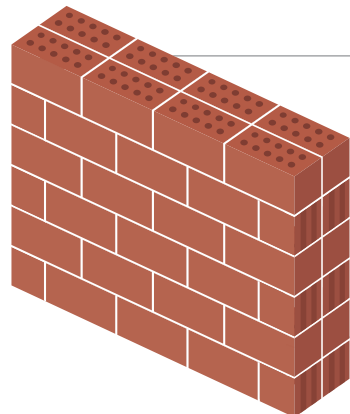

### 110mm - Standard

- Solid wall.
- 10mm mortar core between two leaves.
- Wall thickness: 230mm.

$$R_w \text{ 59 (-1;-5)}$$

ATF Report 1610

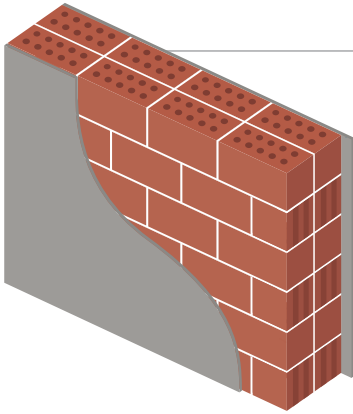

### 110mm - Standard

- Solid wall.
- 10mm mortar core between two leaves.
- 13mm cement render both sides.
- Wall thickness: 256mm.

**R<sub>w</sub> 61 (-1;-5)**

ATF Report 1615

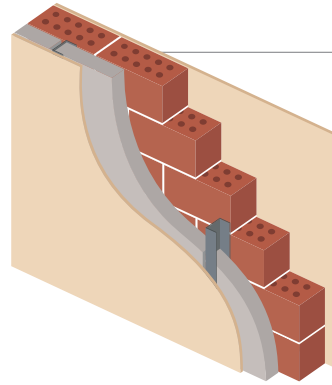

### 110mm - Standard

- Single skin bricks.
- 13mm plasterboard direct fixed one side.
- 13mm plasterboard screw fixed to 64mm Rondo Steel Stud built 15mm from wall with 64mm track top and bottom with insulation on other side.
- Wall thickness: 215mm.
- Discontinuous construction.

**R<sub>w</sub> 62 (-3;-9)**

ATF Report 1125

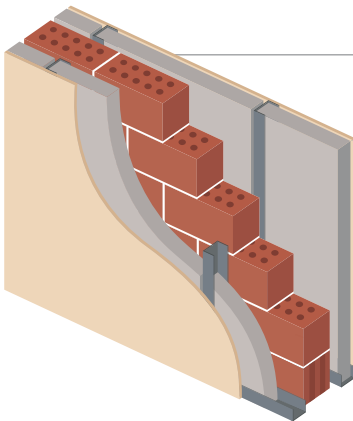

### 110mm - Standard

- Single skin bricks.
- 13mm plasterboard screw fixed to 64mm Rondo Steel Stud built 15mm from wall with 64mm track top and bottom with 9kg/m<sup>3</sup> polyester insulation both sides.
- Wall thickness: 294mm.
- Discontinuous construction.

**R<sub>w</sub> 70 (-5;-13)**

ATF Report 1123

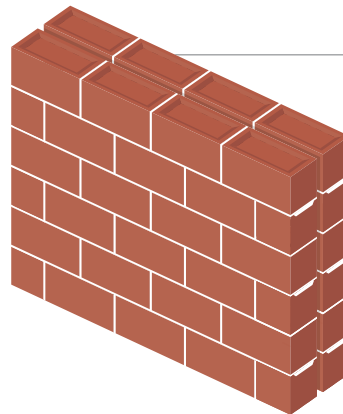

### 110mm - Dry Press

- Cavity wall.
- 50mm cavity.
- Wall thickness: 270mm.
- Discontinuous construction.

**R<sub>w</sub> 53 (-1;-3)**

ATF Report 1174

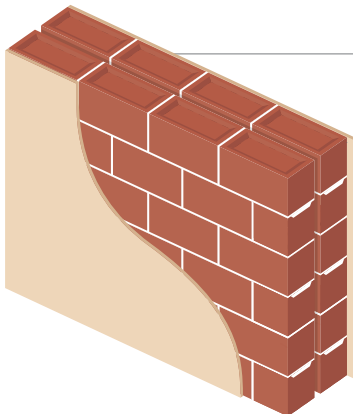

### 110mm - Dry Press

- Cavity wall.
- 40mm cavity.
- 10mm plasterboard direct fixed both sides.
- Wall thickness: 280mm.
- Discontinuous construction.

**R<sub>w</sub> 54 (-1;-4)**

ATF Report 1463A

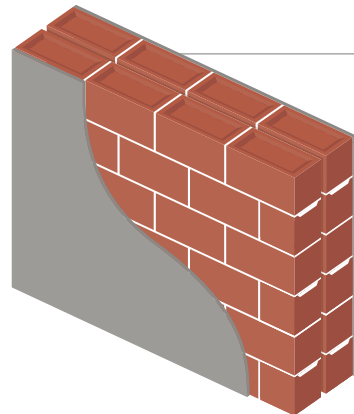

### 110mm - Dry Press

- Cavity wall.
- 50mm cavity.
- 13mm cement render both sides.
- Wall thickness: 296mm.
- Discontinuous construction.

**R<sub>w</sub> 55 (-1;-4)**

ATF Report 1175

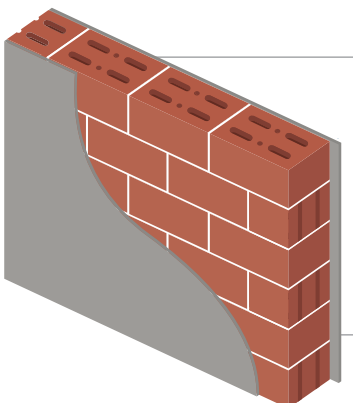

### 150mm - TW

- Single skin bricks.
- 12mm cement render both sides.
- Wall thickness: 174mm.

**R<sub>w</sub> 55 (-1;-5)**

ATF Report 1596

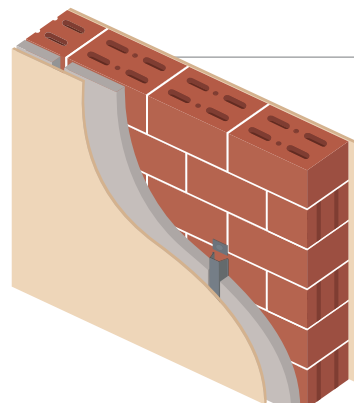

### 150mm - TW

- Single skin bricks.
- 13mm sound resistant plasterboard direct fixed one side.
- 13mm sound resistant plasterboard screw fixed to resilient mounted furring channels with 9kg/m<sup>3</sup> polyester insulation on other side.
- Wall thickness: 217mm.

**R<sub>w</sub> 60 (-2;-8)**

ATF Report 1595

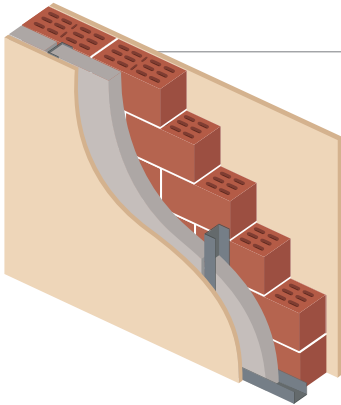

### 110mm - Boxer LW

- Single skin bricks.
- 13mm fire-rated plasterboard direct fixed one side.
- 13mm fire-rated plasterboard screw fixed to 64mm steel stud built 20mm from wall with 64mm track top and bottom with Autex ASB5 insulation other side.
- Discontinuous construction.
- Wall thickness: 220mm.

**R<sub>w</sub> 59 C<sub>tr</sub>-8**

Opinion PKA-A068

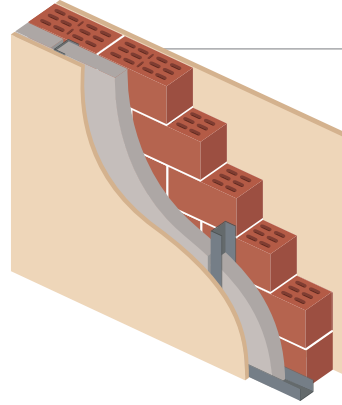

### 110mm - Boxer LW

- Single skin bricks.
- 13mm impact-rated plasterboard direct fixed one side.
- 13mm impact-rated plasterboard screw fixed to 64mm steel stud built 20mm from wall with 64mm track top and bottom with Autex ASB5 insulation other side.
- Discontinuous construction.
- Wall thickness: 220mm.

**R<sub>w</sub> 60 C<sub>tr</sub>-7**

Opinion PKA-A068

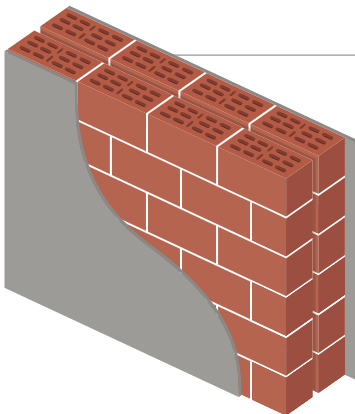

### 110mm - Boxer LW

- Cavity Wall
- 50mm cavity with no wall ties.
- 13mm render both sides
- Discontinuous construction.
- Wall thickness: 296mm.

**R<sub>w</sub> 60 C<sub>tr</sub>-5**

Opinion PKA-A068

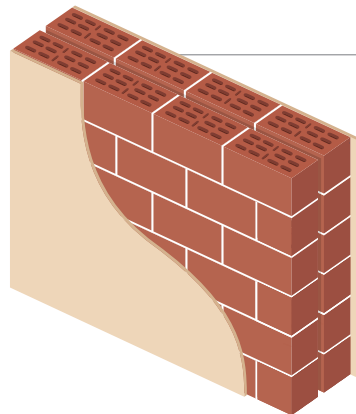

### 110mm - Boxer LW

- Cavity wall.
- 50mm cavity with no wall ties.
- 16mm fire-rated plasterboard direct fixed both sides.
- Discontinuous construction.
- Wall thickness: 302mm.

**R<sub>w</sub> 58 C<sub>tr</sub>-6**

Opinion PKA-A068

## R<sub>w</sub> ≥ 50 Test Results

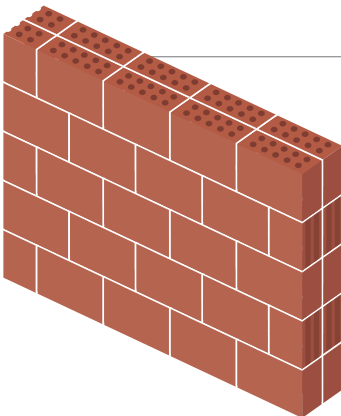

### 90mm - Maxi

- Solid wall.
- 10mm mortar core between two leaves.
- Wall thickness: 190mm.

**R<sub>w</sub> 50 (-1;-5)**

ATF Report 1607

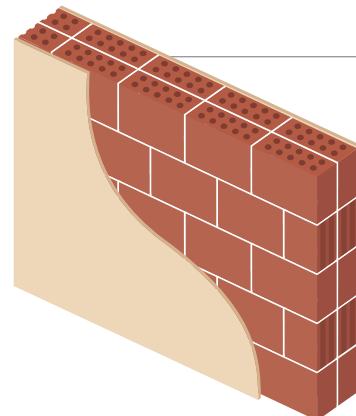

### 90mm - Maxi

- Solid wall.
- 10mm mortar core between two leaves.
- 13mm sound resistant plasterboard direct fixed both sides.
- Wall thickness: 216mm.

**R<sub>w</sub> 53 (-1;-5)**

ATF Report 1608

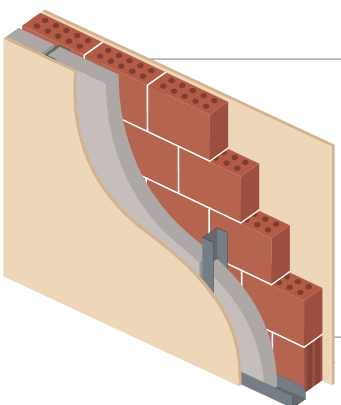

### 90mm - Maxi

- Single skin bricks.
- 13mm plasterboard direct fixed one side.
- 13mm plasterboard screw fixed to 64mm Rondo Steel Stud built 15mm from wall with 64mm track top and bottom with 9kg/m³ polyester insulation on other side.
- Wall thickness: 195mm.
- Discontinuous construction.

**R<sub>w</sub> 57 (-2;-8)**

ATF Report 1132

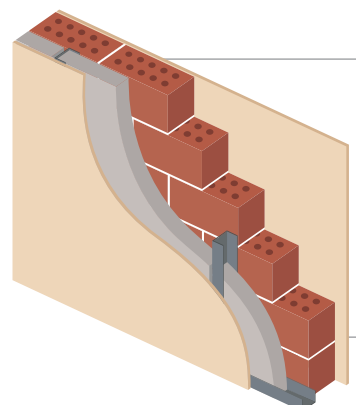

### 110mm - Standard

- Single skin bricks.
- 13mm plasterboard direct fixed one side.
- 13mm plasterboard screw fixed to resilient mounted furring channels with 9kg/m³ polyester insulation on other side.
- Wall thickness: 177mm.

**R<sub>w</sub> 53 (-4;-10)**

ATF Report 951

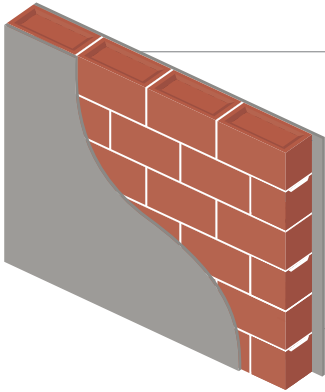

### 110mm - Dry Press

- Single skin bricks.
- 12mm cement render both sides.
- Wall thickness: 134mm.

**R<sub>w</sub> 52 (-1;-5)**

ATF Report 1125

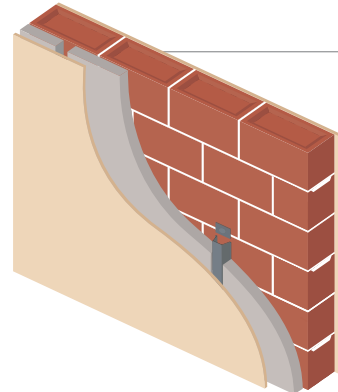

### 110mm - Dry Press

- Single skin bricks.
- 13mm plasterboard direct fixed one side.
- 13mm plasterboard screw fixed to resilient mounted furring channels with 9kg/m³ polyester insulation on other side.
- Wall thickness: 177mm.

**R<sub>w</sub> 56 (-3;-9)**

ATF Report 1391

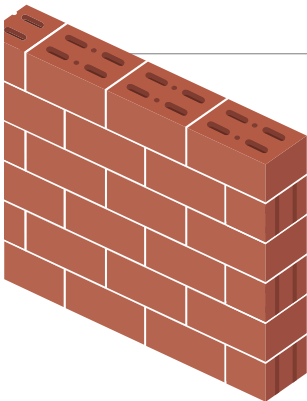

### 150mm - TW

- Single skin bricks.
- Wall thickness: 150mm.

**R<sub>w</sub> 50 (-1;-5)**

ATF Report 1594

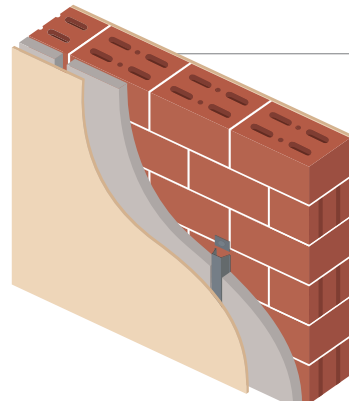

### 150mm - TW

- Single skin bricks.
- 13mm plasterboard direct fixed one side.
- 13mm plasterboard screw fixed to resilient mounted furring channels with 9kg/m³ polyester insulation on other side.
- Wall thickness: 217mm.

**R<sub>w</sub> 56 (-2;-9)**

ATF Report 1117

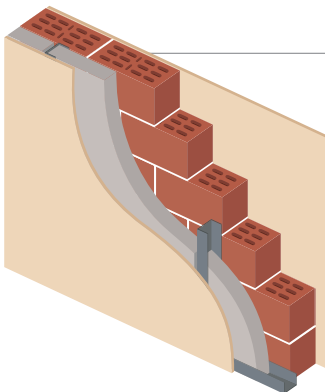

### 110mm - Boxer LW

- Single skin bricks.
- 10mm plasterboard direct fixed one side.
- 10mm plasterboard screw fixed to 64mm steel stud built 20mm from wall with 64mm track top and bottom with 9kg/m³ polyester insulation other side.
- Discontinuous construction.
- Wall thickness: 214mm.

**R<sub>w</sub> 56 (-2;-8)**

ATF Report 1899

# 4.5 WA Utility Bricks

## Test Results



Resilient Wall Ties

### 90-50-90 cavity brick wall with resilient ties

- 13mm render with 2mm plaster set both sides
- Double 90mm Verticore brick (300 x 90 x 162h) with 37% core at 5.56 kg/brick
- 50mm cavity with Matrix resilient ties at 600mm centres

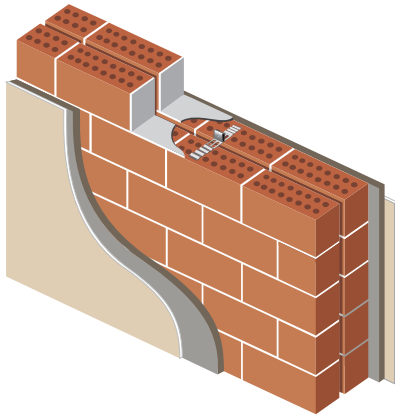

Results:  $R_w$  (-1; -4)  
 $R_w + C_{tr}$  42

### 90-70-90 cavity brick wall with resilient ties

- 13mm render with 2mm plaster set both sides
- Double 90mm Verticore brick (300 x 90 x 60h)
- 70mm cavity with Matrix resilient ties at 600mm centres

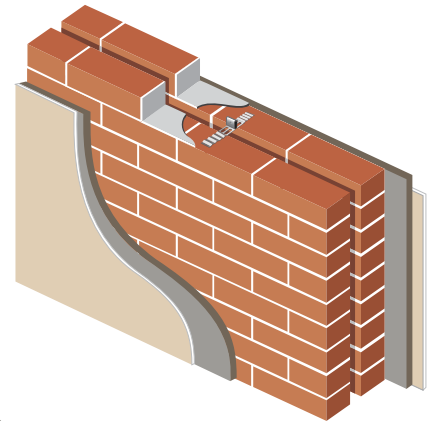

Results:  $R_w$  (-2; -6)  
 $R_w + C_{tr}$  55

### 90-50-90 insulated cavity brick wall with no ties

- 10mm render with 2mm plaster set both sides
- Double 90mm Verticore brick (300 x 90 x 162h) with 37% core at 5.56 kg/brick
- 50mm cavity with 50mm Bradford Glass Wool Partition Batts (11 Kg/m<sup>3</sup>)

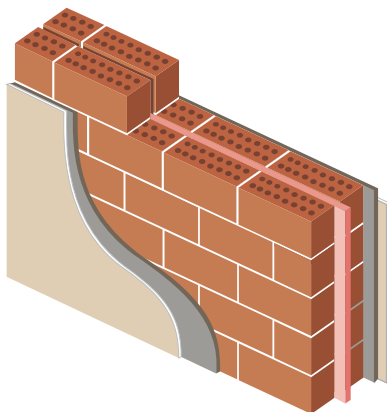

Results:  $R_w$  (-2; -6)  
 $R_w + C_{tr}$  55

### 90-70-90 cavity brick wall with no ties

- Double 90mm Verticore brick (305 x 90 x 60h)
- 70mm cavity with no ties
- Struck joints

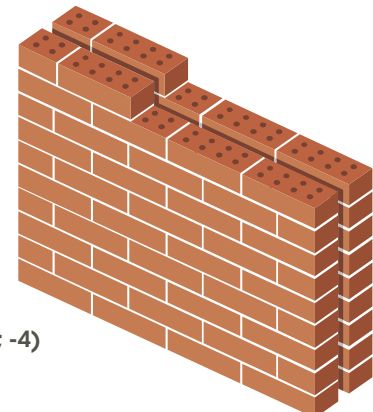

Results:  $R_w$  54 (-2; -4)  
 $R_w + C_{tr}$  50

**90-70-90 rendered cavity brick wall with resilient ties**

- 13mm render with 2mm plaster set both sides
- Double 90mm Verticore brick (300 x 90 x 162h) with 41% core at 5.0 Kg/brick
- 70mm cavity with Matrix resilient ties at 600mm centres

**Results:  $R_w$  (-1; -5)  
 $R_w + C_{tr}$  55**

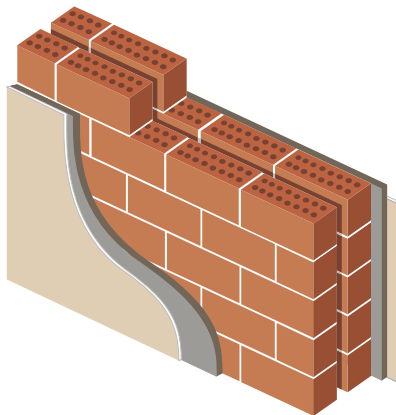

**90-70-90 cavity brick wall with no ties**

- 13mm render with 2mm plaster set both sides
- Double 90mm Verticore brick density (305 x 90 x 60h)
- 70mm cavity with no ties

**Results:  $R_w$  61 (-2, -6)  
 $R_w + C_{tr}$  55**

**All tested to AS1191**

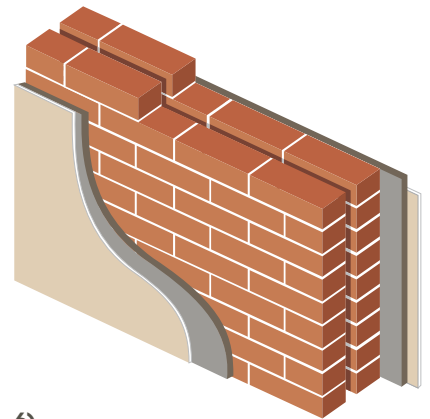



# DESIGN CONSIDERATIONS



BOWRAL BRICKS



nubrik®  
authentic brickwork

# 5.1 Design for Durability

## 5.1.1 General

For a structure to remain serviceable, it must be durable throughout its life, assuming a reasonable level of building maintenance is carried out. The main causes of durability failure are corrosion of embedded steel items and the effects of crystalline salts in the masonry. These salts can be absorbed from either the ground, or from materials such as the sand used in the mortar mix.

To ensure adequate serviceability, AS 3700 requires a structure to have the necessary durability to withstand the expected wear and deterioration throughout the intended life – typically 50 years, without the need for

excessive maintenance. For any building element, the required durability depends on the exposure environment, the location within the building and the importance of the structure.

AS 3700 gives extensive deemed-to-satisfy solutions for each of the wall components and for a range of environmental conditions. In order to satisfy the requirements, each component must be graded in accordance with its respective durability. Durability requirements are stipulated for each combination of environment and location.

The exposure environments referred to in Table 5.1 of AS 3700 are as follows:

**Table 1** – Exposure Environments

<b>Severe marine</b> Up to 100 metres from a non-surf coast and up to 1 km from a surf coast. The coast is defined as the mean high-water mark.
<b>Marine</b> Between 100 metres and 1 km from a nonsurf coast and between 1 kilometre and 10 kilometres from a surf coast. As before, the coast is defined as the mean high-water mark.
<b>Industrial</b> Within 1 km of major industrial complexes producing significant acidic pollution.
<b>Moderate</b> Areas within 50 km of the coast and more than 1 km from a non-surf coast, or 10 km from a surf coast. These are considered to be subject to light industrial pollution and/or very light marine influence.
<b>Mild</b> Typically inland, more than 50 km from the coast and away from industrial areas. This environment has been subdivided as follows: <ul style="list-style-type: none"><li>• Mild-tropical – within the tropical climatic zone (for example, Katherine and Mt Isa).</li><li>• Mild-temperate – within the temperate climatic zone (for example, Dubbo and Mildura).</li><li>• Mild-arid – within the arid climatic zone (for example, Alice Springs and Kalgoorlie)</li></ul>

### 5.1.2 Masonry units

When masonry units absorb moisture containing dissolved salts, damage can result when this moisture dries out. This damage can effect either the mortar joints (if the mortar is soft) or to the units, and sometimes to both.

The mechanism operating is that the dissolved salts crystallise just below the surface as the moisture evaporates and the growth of the crystals causes

physical stresses leading to particles being dislodged from the surface; this is referred to as salt attack.

A standard salt cycling test is given in AS/NZS 4456.10 to measure the resistance of masonry units to salt attack. The available grades, in order of increasing resistance, are Protected, General Purpose and Exposure.

**Table 2** – Durability Levels

**Protected Grade Bricks** are usually used for internal walls above a damp –proof course.

**General Purpose Grade Bricks** are suitable for use in external walls in mild exposure environments and normal (non-wet area) interior walls.

**Exposure Grade Bricks** are suitable for saline environments and should always be used below the damp-proof course and in other locations of severe exposure.



**Figure 1** – Salt attack damage to masonry unit



**Figure 2** – Salt attack damage to mortar

### 5.1.3 Mortar

The resistance of mortar joints to degradation during the life of a building is related to surface hardness, which is strongly related to cement content. Low hardness will lead to progressive erosion of the surface of the joints by physical damage, wind action, insect attack and the effects of salt crystallisation.

Mortar is classified in AS 3700 as grades M1, M2, M3 or M4. These grades are used for durability requirements as well as for strength properties. Mortar of type M1 can only be used for restoration work to match existing construction and therefore has no corresponding durability provisions. Refer to Mortar section 2.5 in this manual for more details.

### 5.1.4 Ties, Connectors and Lintels

Wall ties are readily available for a range of exposure environments in galvanised steel, stainless steel and polymer. Designers and specifiers should consider carefully the consequences of failure during the design life of the building and choose the materials accordingly. The cost to replace these items should they fail is far more expensive than their original cost and therefore should not be considered in any cost saving scenarios

Wall ties and other built-in components such as connectors for control joints, connectors for attachment of masonry to building frames, and lintels, are required to have a rating for durability (called a durability class). The durability ratings required by AS 3700 are R0, R1, R2, R3, R4 and R5. Table 5.1 in AS 3700 sets out the required durability rating for each exposure environment and location using the symbols R0 to R5.

Durability class R5 is intended for critical applications in special situations such as tidal and splash zones or areas of heavy chemical pollution. No test criteria or deemed-to-satisfy solutions are given for the R5 rating.

Wall ties manufactured from non metallic materials such as polymers are also available and can be used provided they have been shown to satisfy the exposure conditions set out in AS/NZS 2699.1 corresponding to the requirements of AS 3700

AS/NZ 2699.1 requires all ties to be marked on the packaging and on individual ties with the durability rating. For the packaging, this must consist of a reference to AS/NZS 2699.1 and a rating (R0 to R5). For individual ties, they should be stamped with 0 to 4, indicating the corresponding rating R0 to R4, or colour coded as follows:

**Table 3 – Tie Durability Rating**

<b>R0 and R1</b> - green
<b>R2</b> - yellow
<b>R3</b> - red
<b>R4</b> - white or blue

### 5.1.5 Reinforcement

Reinforcing bars can be provided with a corrosion resistant coating to achieve the required durability rating, but will usually rely on a minimum grout cover to ensure an acceptable level of resistance. Refer to Table 5.1 in AS 3700 for full details.

Reinforcement embedded in mortar joints must have corrosion protection to achieve a durability rating of R0 to R5, as for ties and accessories, plus a minimum cover of 15mm of mortar to the outside of the masonry. The requirement for separate protection to provide the durability rating is in recognition of the fact that mortar does not give the same degree of protection to the steel as does the cement-rich grout. Clause 5.9 of AS 3700 provides guidance on reinforcement in mortar joints and unbonded tendons.

For further information on Durability, please refer to Section 7 of the Think Brick Australia manual 7, *Design of Clay Masonry for Servicability*.

## 5.2 Robustness of Brickwork

### 5.2.1 Design Principles

AS 3700 requires masonry members and their connections to have an adequate degree of robustness, regardless of the level of load to which they are subjected to.

#### Walls

The principle is that even if a wall is designed to satisfy all the prescribed loads, it should not be so slender as to fail under some unintended or accidental load and it should have adequate stiffness. If the wall is capable of withstanding a minimum level of lateral load of 0.5 kPa, it is deemed to have the necessary robustness.

Consideration must be given to the effects of chasing and door or window openings in a wall when assessing robustness. The edge of an opening is usually considered to be an unrestrained edge of the wall.

#### Piers

Unreinforced isolated piers are more vulnerable than walls and the limiting slenderness ratio for an isolated pier is therefore approximately half the value of a similar wall. A pier usually has both length and width less than one-fifth of the height.

Robustness of isolated piers is controlled by an equation, which gives a limit on height for one-way spanning members as follows:

$$\text{Where } \frac{H}{t_r} \leq C_v$$

H = Clear height of the member (in metres)

$t_r$  = minimum thickness of the member

$C_v$  = Robustness coefficient for vertical span. For piers unreinforced vertically – 13.5. For piers reinforced vertically or pre-stressed – 30.

The stiffening action of engaged piers is only taken into account for walls in pure vertically spanning walls. Even then, the piers must be quite substantial before they are effective. Note that an engaged pier has insufficient strength and stiffness to provide lateral support to the wall. Both leaves of a cavity wall are considered to act together for the purposes of robustness, unlike for compressive strength design.

The charts for walls with side support (leading to two way bending) show a smooth curve, unlike the cases with only top and bottom support, and this recognises the importance and effect of having at least one vertical support to stabilise the wall.

### 5.2.2 Limiting dimensions for robustness

The following charts show limiting heights and lengths for single leaf and cavity walls constructed with clay masonry units of common sizes. Support conditions and the applicable slenderness coefficients are indicated by an icon on each chart.

Where the icon shows hatching along an edge, the corresponding edge of the wall is laterally supported.

The chart for walls supported only at the top and bottom (chart 5) show the transition to limiting heights for isolated piers when the length falls below five times the thickness at the left-hand side.

For further information on Robustness, please refer to section 8 of the Think Brick Australia manual 7, *Design of Clay Masonry for Servicability*.

**Chart 1** – Wall is laterally supported from both ends and the top

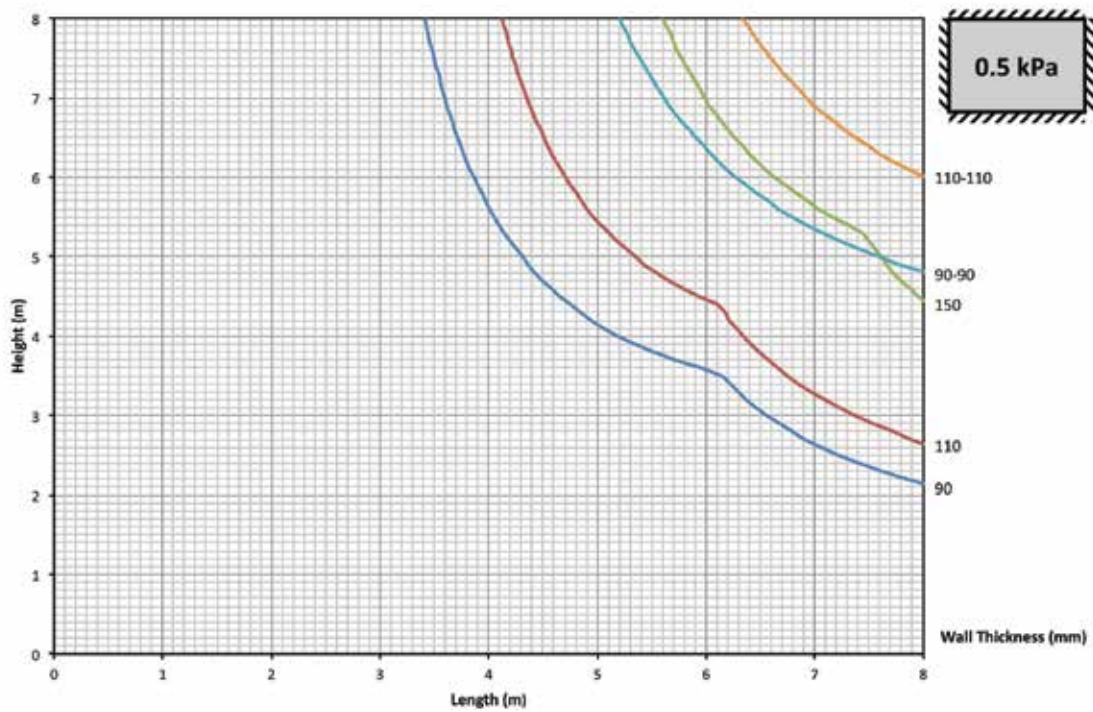

**Chart 2** – Wall is laterally supported from both ends only

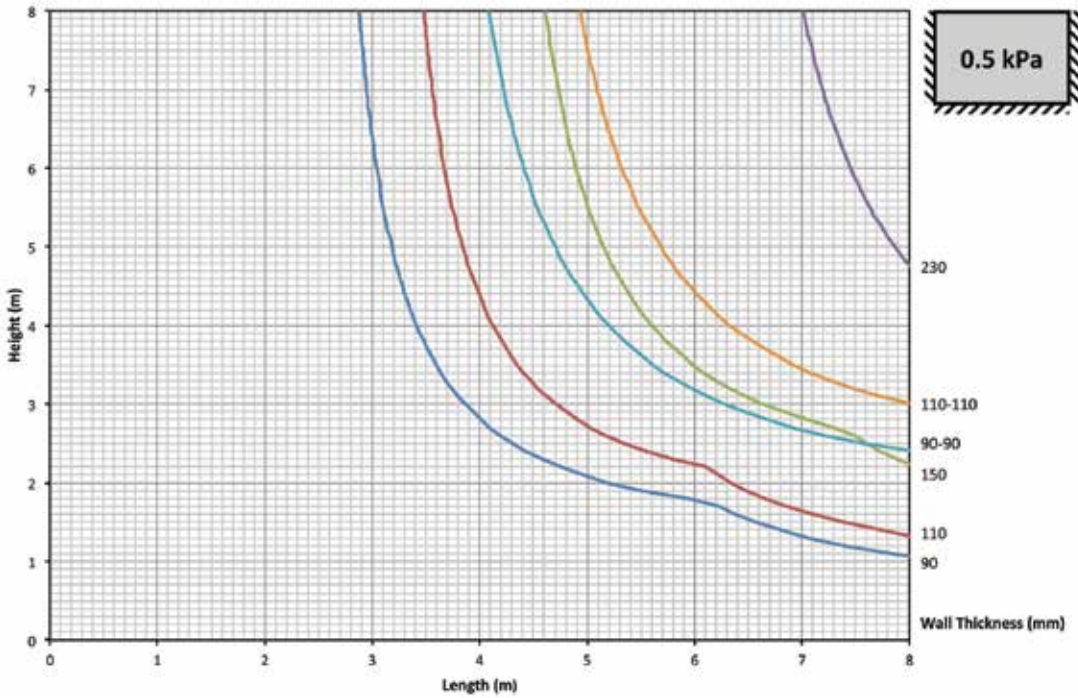

**Chart 3** – Wall is laterally supported from one end and the top

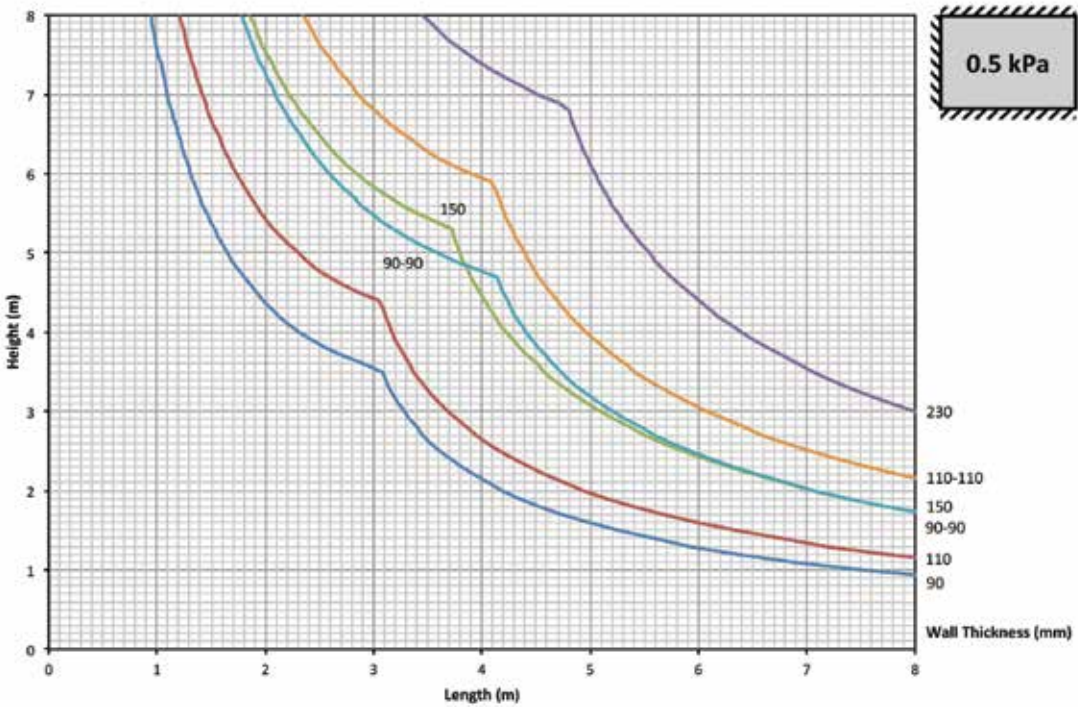

**Chart 4** – Wall is laterally supported from one end only

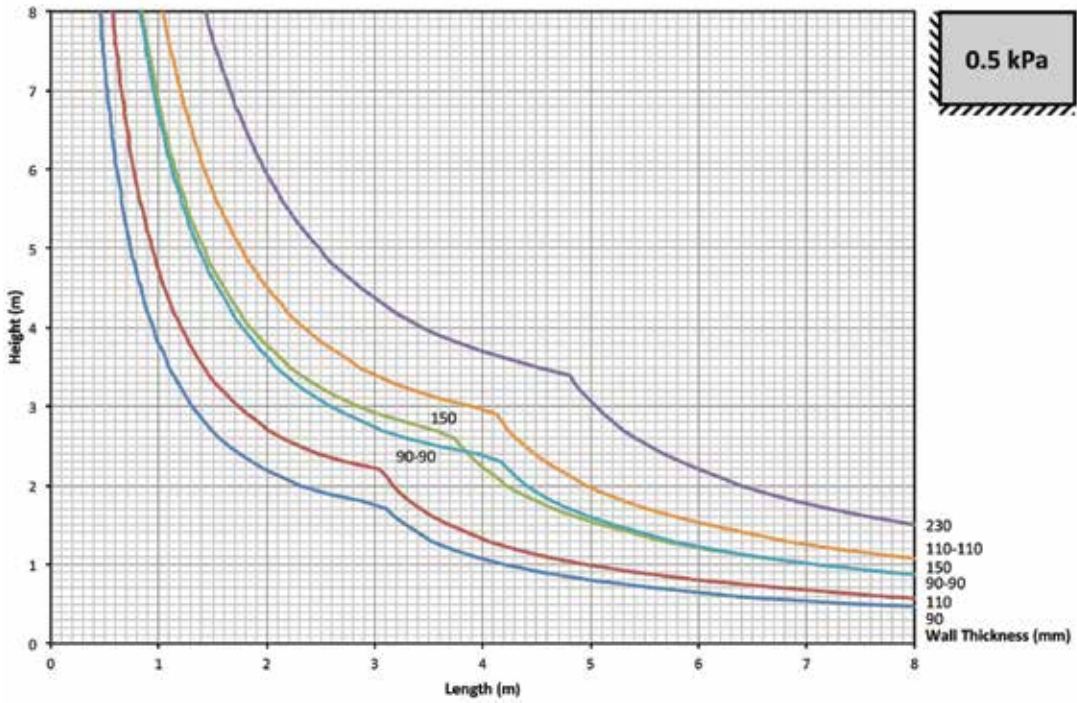

**Chart 5** – Wall is laterally supported from the top only

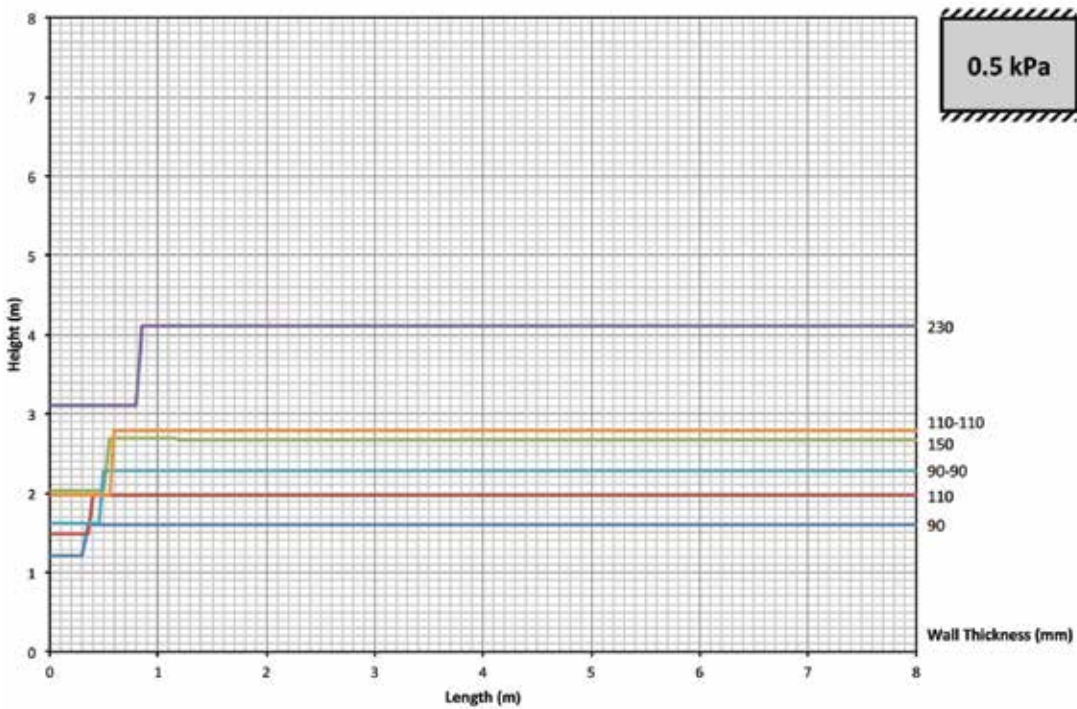



## 5.3 Design to Avoid Cracking

### 5.3.1 General

To avoid cracking in masonry work, the use of both effective tying and support in addition to correct masonry detailing must occur. Assuming the quality of the masonry is adequate, cracking can be avoided by the provision of various forms of control joints and adequate detailing. The positioning of the joints will depend upon the movements for which they are inserted, and in many cases can compensate for several types of movements.

### 5.3.2 Locations of articulation joints

Articulation joints are used in conjunction with a foundation to control the effects of ground movements. The joints articulate the masonry components of the building into separate elements, which undergo movement as the footing deflects, without causing distress in the masonry. The more flexible the footing, or the more vulnerable the surface finish is to cracking, the closer the required spacing of the joints will be. Articulation not only aids in minimising wall cracks, but all helps reduce the likelihood of windows or doors jamming due to foundation movements.

Placement of articulation joints is based on the conditions and also the proposed joint width. Joints should also be included at positions where potential concentrations or variations in the wall stresses might occur, for example at changes in wall height and thickness, at window and door openings, and at the intersection of dissimilar materials.

Articulation joints might also be required for internal walls. With good planning, the joints can be incorporated at full height openings such as doorways.

Where joints are unavoidable, for example in long unbroken lengths of wall, they should be of the same form as joints in the external walls.

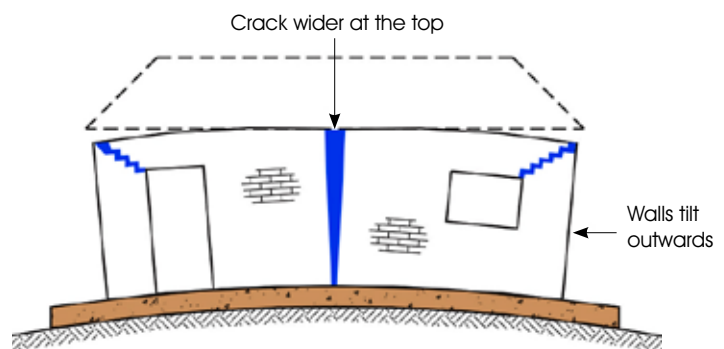

**Figure 3** – Effect of foundation movement on articulated walls (doming foundation)

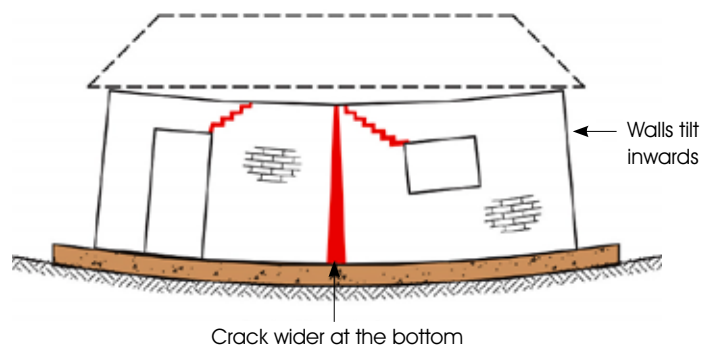

**Figure 4** – Effect of foundation movement on articulated walls (dishing foundation)

Articulation joints might also be required for internal walls. With good planning, the joints can be incorporated at full height openings such as doorways.

Where joints are unavoidable, for example in long unbroken lengths of wall, they should be of the same form as joints in the external walls.

**Table 4** – Recommended maximum spacing of 10mm wide articulation joints in walls up to 2.7m high.

Site Class	Masonry Wall Construction	Joint Spacing (m)
A and S	Any	Not Required
M, M-D	Face finish or sheeted	6.5
H1, H1-D	Rendered and/or paint finish	6.0
H2, H2-D	Face finish or sheeted	6.0
E	Rendered and/or paint finish	5.5
	Face finish or sheeted	5.5
	Rendered and/or paint finish	5.0
	All	Engineering Assessment Required

This is a summary covering simple cases for more information; refer to AS 3700, AS 4773.1 and CCAA TN 61.

Site classes are as follows (refer AS 2870)

A = Most sand and rock sites

S = Most silt and some clay sites

M = Moderately reactive clay sites

D = Dense reactive clay sites

H1 = Highly reactive clay sites with high ground movement due to moisture changes

H2 = Highly reactive clay sites with very high ground movement due to moisture changes

E = Extremely reactive clay sites

For E class sites, a footing design prepared by an engineer is required together with a complementary articulation joint spacing.

### 5.3.3 Detailing of articulation joints

Articulation joints must be capable of expanding or contracting in line with the walls. The joint is usually packed with a compressible filler to provide a backing for the flexible sealant compound applied to the surface of the joint.

Alternatively, a circular polyethylene backer-rod can be used as backing for the sealant. It is extremely important that the joint be free of mortar droppings or other obstructions that will impede the closing of the joint.

Flexible masonry anchors should be installed between the masonry panels on either side of the joint. These anchors are capable of transmitting shear forces across the joint from loads normal to the wall, but still allow the joint to open or close.



Figure 5 – Control Joint

In many cases, articulation joints will also serve as expansion or contraction joints. In clay masonry walls, brick growth will occur over time and tend to close the joint. The initial joint size must allow for this effect and would usually be larger than the common 10 mm joint width. A width of 20 mm would be a typical for this situation, but should be determined by considering the need for control joints.

The use of full height openings for doors and windows is an effective means of articulation. Full height windows, or windows with infill panels below the sill, eliminate the need to form an articulation joint in the masonry. Openings for external doors should also be the full height of the wall if possible. Full height door openings provide an excellent location for articulation joints, which can be covered by the architraves.

### 5.3.4 Control joints

Control joints are required in clay masonry to relieve the effects of long-term expansion of the units. The detailing of these joints is similar to that for articulation joints.

Brick growth or expansion is irreversible and takes place in both the horizontal and vertical direction. Control joints must therefore be inserted to absorb this expansion and avoid damage to the masonry. Corners are particularly prone to damage as the growth occurs in orthogonal directions in the two intersecting walls. For this reason, a control joint should be located at or near a corner if long lengths of brickwork are involved.

For further information on how to avoid cracking in your masonry work, please refer to section 4-6 of the Think Brick Australia Manual 7, *Detailing of Clay Masonry for Servability*.

# 5.4 Design Considerations of Designa Basalt

Designa Basalt can be used as an external cladding material in a brick veneer or a cavity wall. Wall ties are used to secure the Designa Basalt to either the building frame or to another layer of masonry. Typical details are shown below.

In general, wall ties must have 50mm embedment and 15mm cover to external surface of mortar. To achieve this with a 40 to 50mm cavity the maximum raking permitted is 5mm.

When face fixed ties are used, they are to be screw fixed. Alternatively, side fixed ties can be screw or nail fixed.

In a stretcher bonded brick veneer wall or a cavity wall, wall ties must be installed at maximum 600mm centres both horizontally and vertically. In a stack bonded brick veneer wall or a cavity wall, wall ties must be installed at maximum 450mm centres horizontally.

## Cavity Brick

Figure 6 – Typical Eave Detail

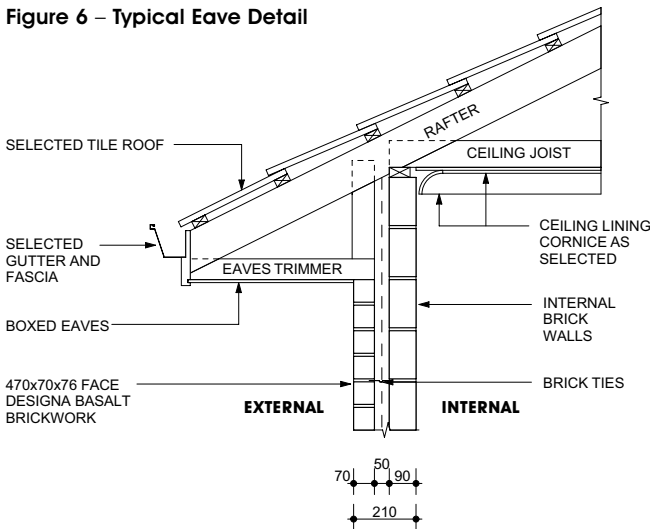

## Brick Veneer

Figure 8 – Typical Eave Detail

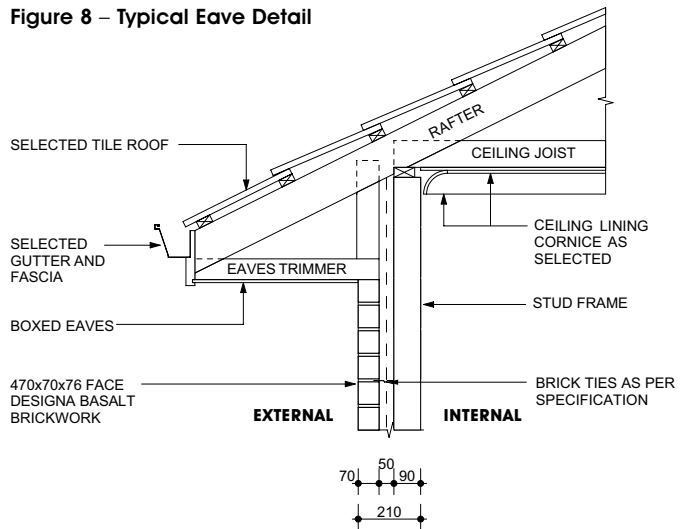

Figure 7 – Typical Footing Connection

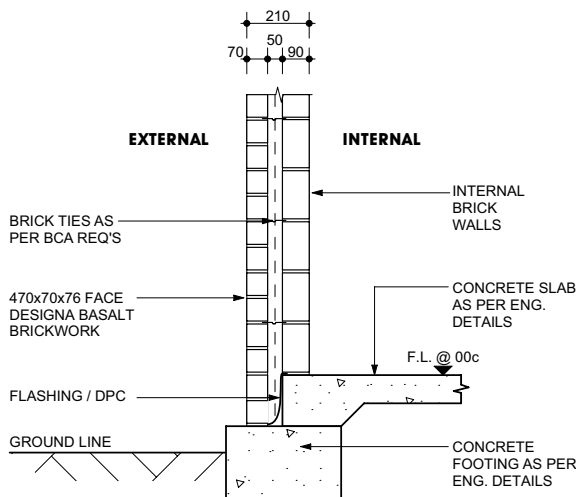
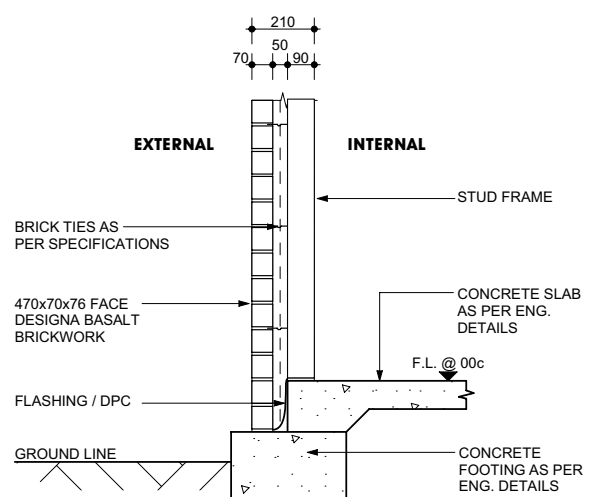

Figure 9 – Typical Footing Connection



### Wall Tie Requirements

In a stretcher bonded brick veneer wall or cavity wall, when wall ties are placed at a vertical spacing of

600mm centres, the grade of wall ties in each wind class is dictated by their horizontal spacing as shown below.

**Table 5** – Wall Tie Spacing - 600mm vertical centres

Wind class	Maximum horizontal spacing (mm)					
	General area			Within 1200mm of corners		
	300	450	600	300	450	600
N1	L	M	M	M	M	H
N2	L	M	M	M	H	H
N3	M	H	H	H	H	-
N4/C1	H	H	H	H	-	-
N5/C2	H	-	-	-	-	-
N6/C3	H	-	-	-	-	-
C4	-	-	-	-	-	-

Note: "L" = light duty, "M" = medium duty, "H" = heavy duty, "-" = no ties suitable.

Refer to Table 3.5 of AS 3700 for mean tie strength for each duty rating.

**Figure 10** – Example showing bed course location for wall ties placed at a vertical spacing of 600mm centres and a horizontal spacing of 450mm centres

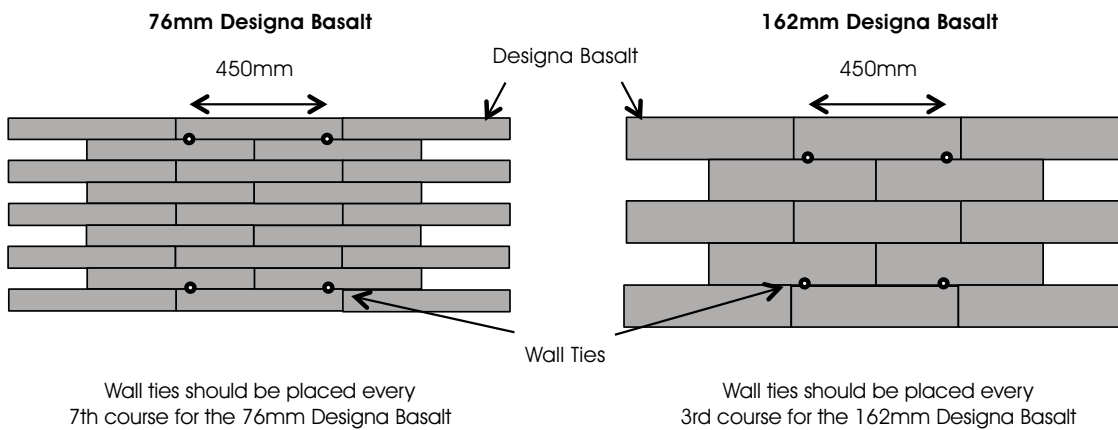

In a stretcher bonded brick veneer wall or cavity wall, when wall ties are placed at a vertical spacing of 450mm centres, the grade of wall ties in each wind

class region is dictated by their horizontal spacing as shown below.

**Table 6** – Wall Tie Spacing - 450mm vertical centres

Wind class	Maximum horizontal spacing (mm)					
	General area			Within 1200mm of corners		
	300	450	600	300	450	600
N1	L	L	M	L	M	H
N2	L	M	M	M	M	H
N3	M	M	H	H	H	-
N4/C1	M	H	H	H	-	-
N5/C2	H	H	-	H	-	-
N6/C3	H	-	-	-	-	-
C4	-	-	-	-	-	-

Note: "L" = light duty, "M" = medium duty, "H" = heavy duty, "-" = no ties suitable.

Refer to Table 3.5 of AS 3700 for mean tie strength for each duty rating.

**Figure 11** – Example showing bed course location for wall ties placed at a vertical spacing of 450mm centres and a horizontal spacing of 600mm centres

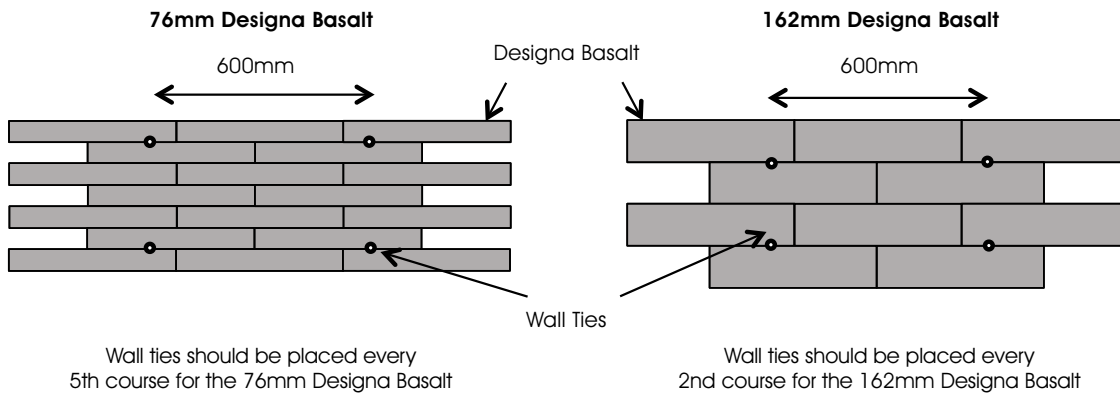

For stack bond, horizontal spacing of wall ties must be limited to one tie every 450 mm. The grade

of wall ties in each wind class region is dictated by their vertical spacing as shown below:

**Table 7** – Wall Tie Spacing - 450mm vertical centres and 450mm horizontal centres

Wind Class	Wall tie vertical spacing of 600mm		Wall tie vertical spacing of 600mm	
	General area	Within 1200mm of corners	General area	Within 1200mm of corners
N1	M	M	L	M
N2	M	H	M	M
N3	H	H	M	H
N4/C1	H	-	H	H
N5/C2	-	-	H	-
N6/C3	-	-	-	-
C4	-	-	-	-

Note: "L" = light duty, "M" = medium duty, "H" = heavy duty, "-" = no ties suitable.  
Refer to Table 3.5 of AS 3700 for mean tie strength for each duty rating.

**Figure 12** – Example showing bed course location for wall ties placed at a vertical spacing of 450mm centres and a maximum horizontal spacing of 450mm centres

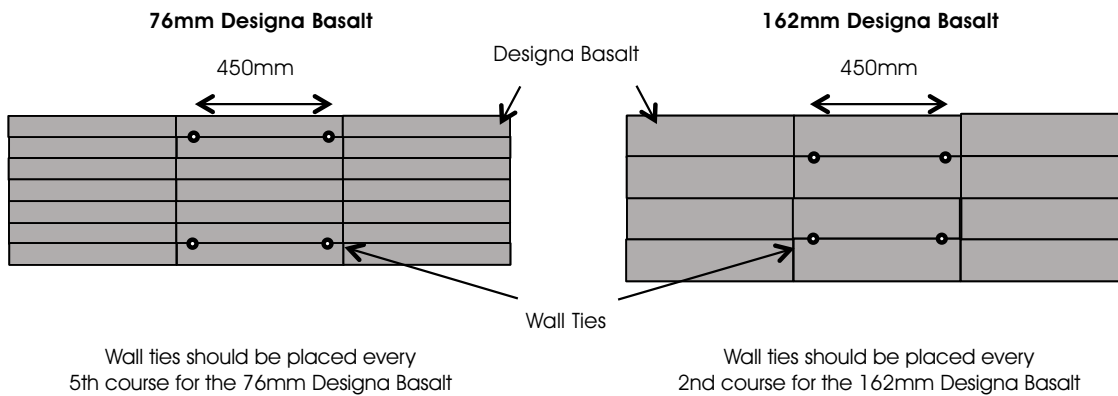

### Internal non-loadbearing wall

Designa Basalt at 70mm thick cannot be used as a single leaf internal wall. Internal non-loadbearing walls need to satisfy the 0.5kPa lateral load

requirements as set out in AS 3700. To satisfy this requirement, Designa Basalt must be constructed as a solid wall combined with a 90mm brick. Typical details are shown below.

Figure 13 – Typical Internal Wall Suspended Slab Detail

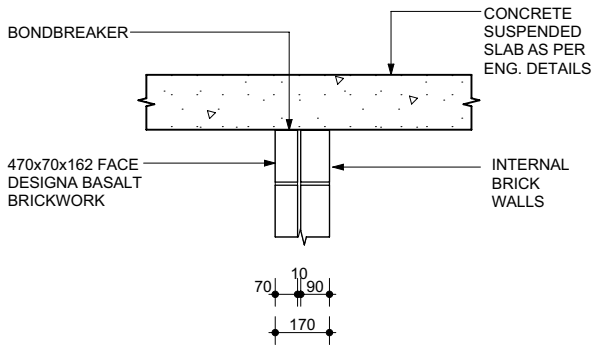
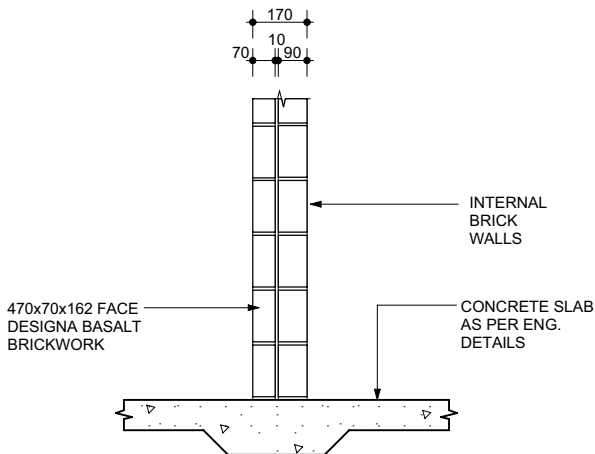

Figure 14 – Typical Internal Wall Detail





**Internal Wall Design**

When Designa Basalt is laid as a solid wall combined with regular 90mm bricks in a stretcher bond manner, the dimensions of the wall are dictated by the amount of support the wall has.

Consult graph 1-5 for the dimensions of the walls. For stack bond, only graph 1 "Laterally supported top only" applies.

**Chart 6** – Wall is laterally supported from the top only

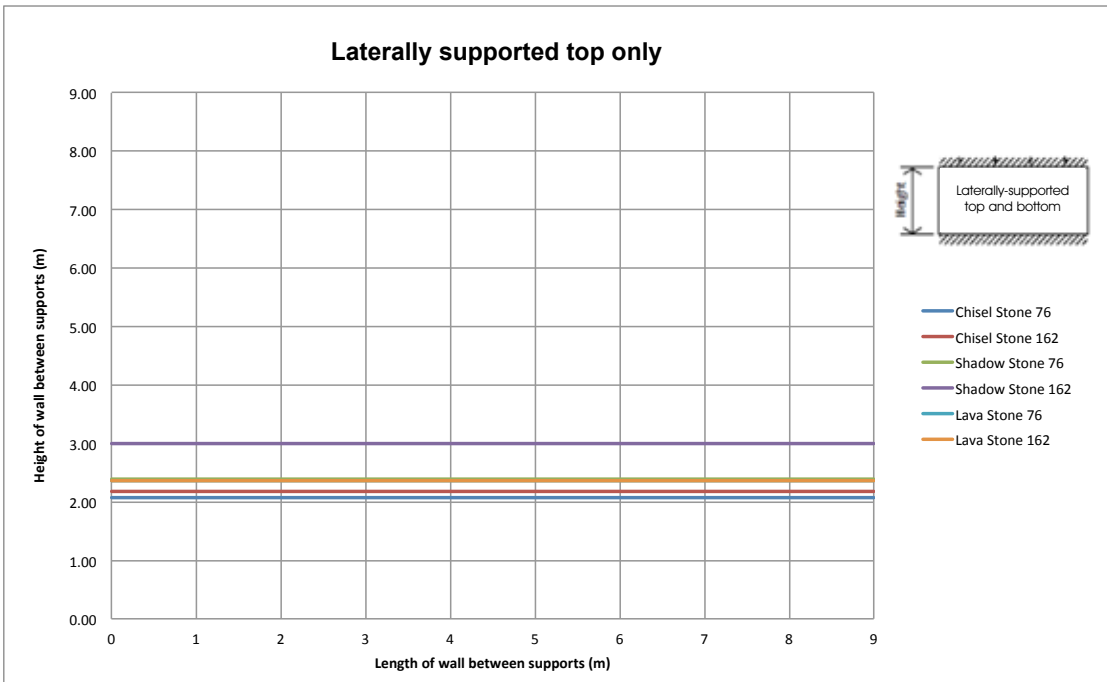

**Chart 7** – Wall is laterally supported from both ends and the top

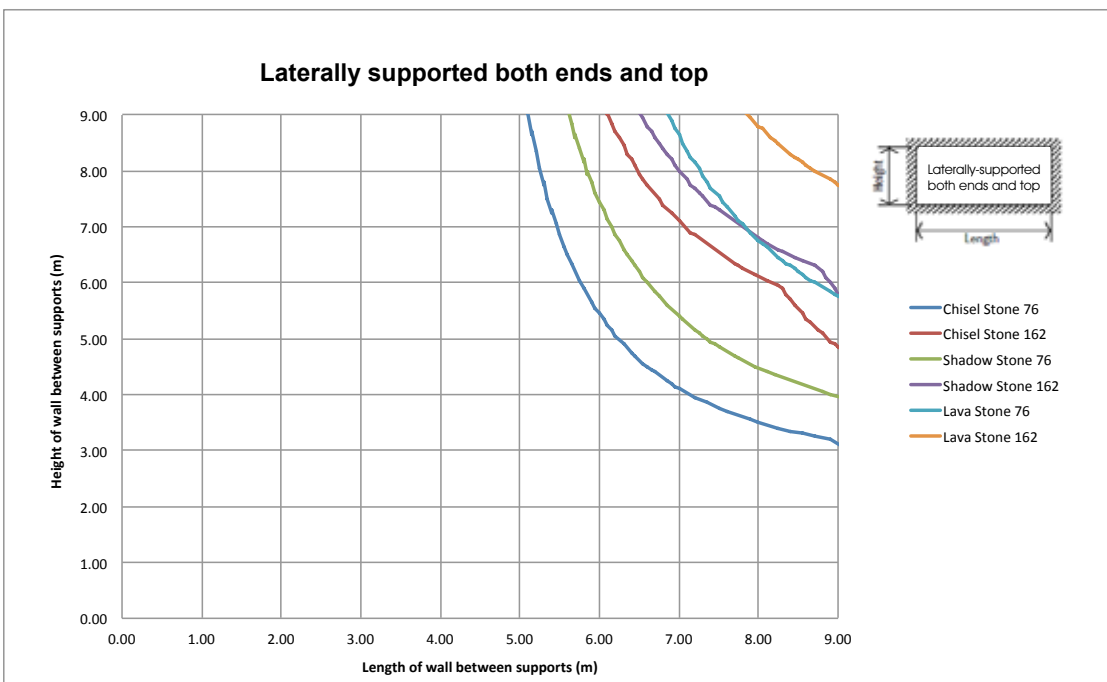

**Chart 8** – Wall is laterally supported from both ends only

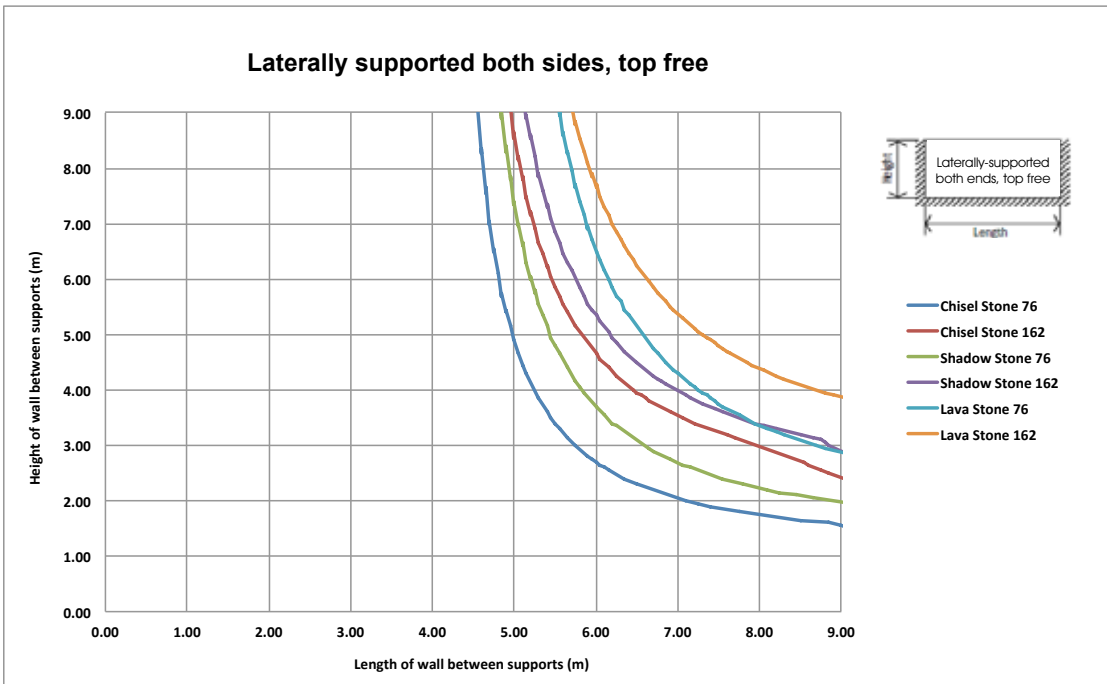

**Chart 9** – Wall is laterally supported from one end and the top

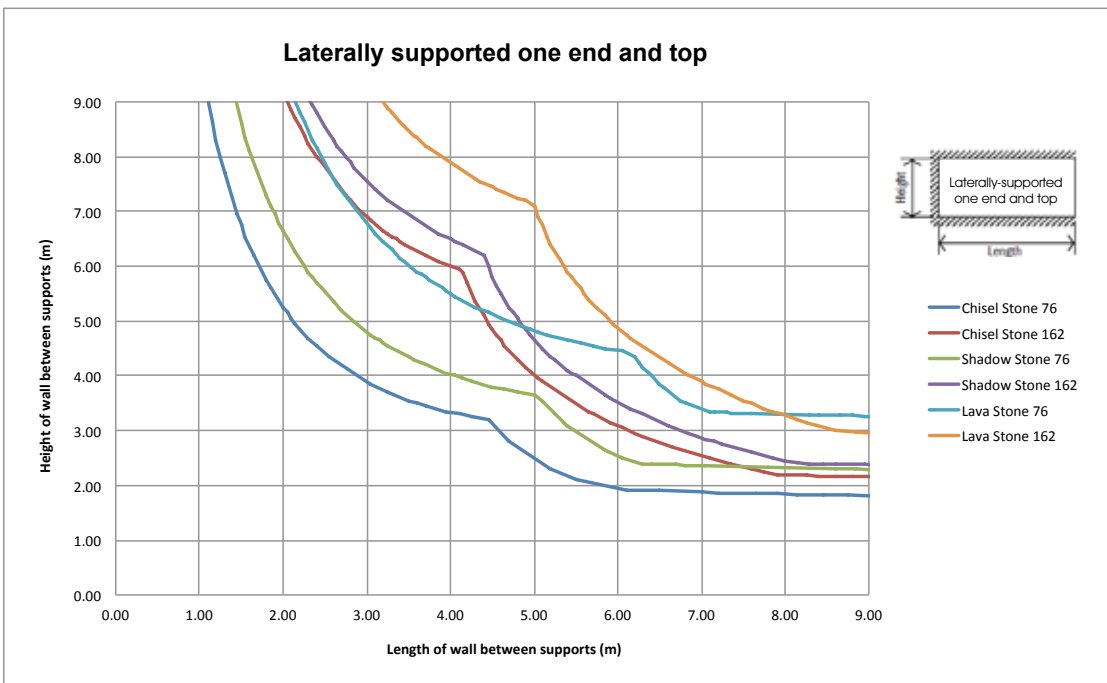

**Chart 10** – Wall is laterally supported from one end only

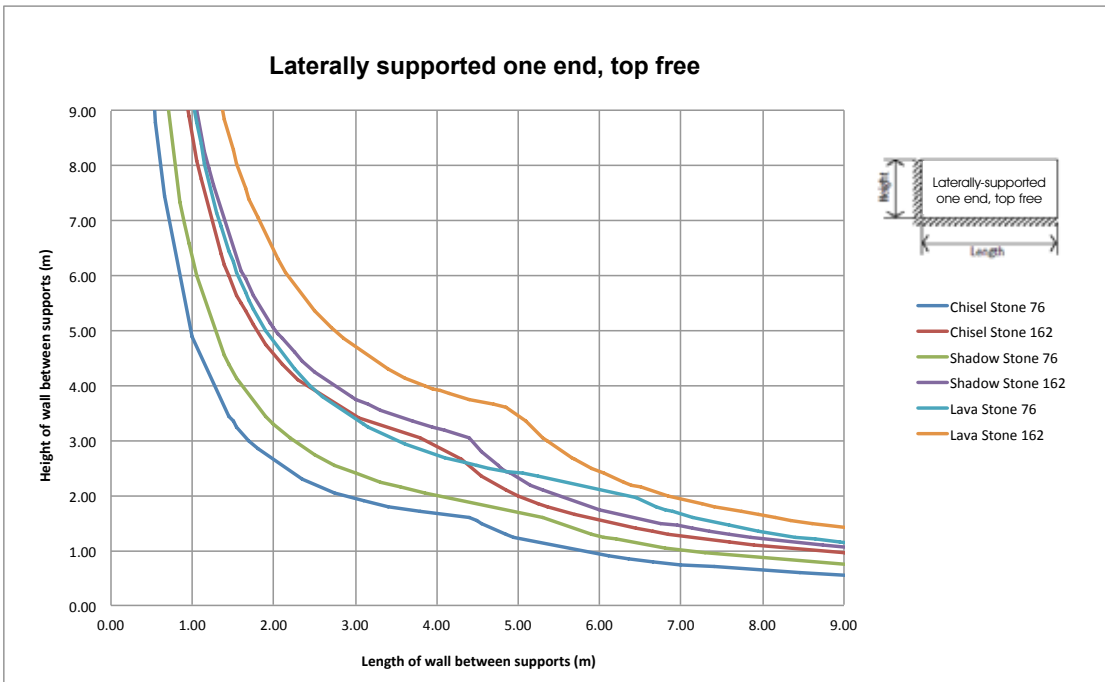

# 5.5 Armabeam Clay Brick Lintels

(Available in Western Australia only)

The strength of a fired clay product ensures compatibility with rendered surfaces and reduces the possibility of cracking. Perfect for construction in the coastal areas of Western Australia.

ARMABEAM clay brick lintels are ideal for both domestic and commercial applications, and are intended for use in single-storey constructions or in the uppermost storey of multi-storey constructions.

ARMABEAM is a composite construction of cored clay brick, concrete and galvanised deformed reinforcing bar.

The application of ARMABEAM is subject to loading requirements. (Subject to your engineer's or builder's specification).

**\* Minimum overhang 150mm.  
Recommended 230mm.**

Please note: Beware of non-galvanised lintels! Builders using non-galvanised lintels run the risk of non-compliance with building codes and the possibility of litigation.



- A fired clay product ensures compatibility with rendered surfaces. No cracking of plaster unlike some lintels.
- Galvanised reinforcing bars for strength are less corrosive than normal steel.
- The galvanised deformed reinforcing bar is perfect for construction in coastal areas.
- 3.140 lintel spans up to 2680mm.

**Table 8** – Standard lintel sizes

Standard lintel sizes		
No. of clay bricks in lintel	Overall lintel length (m)	Weight (kg)
3	0.935	28
3.4	1.080	32
3.5	1.110	34
3.7	1.185	35
4	1.250	37
5	1.565	46
6	1.880	56
7	2.195	64
8	2.510	74
9	2.825	84
10	3.140	92

## 5.6 Brick Estimator

The following values do not allow for any brick wastage.  
It is recommended that you allow approximately 5% extra to cover this.

**Table 9** – Brick estimator

Brick Dimensions	Number of Bricks
230 x 110 x 76	48.5
230 x 110 x 119	32.3
230 x 110 x 162	24.3
290 x 90 x 76	38.8
290 x 90 x 90	33.3
290 x 90 x 119	25.8
290 x 90 x 162	19.4
305 x 90 x 76	36.9
305 x 90 x 162	18.5

# 5.7 Brick Coursing Heights

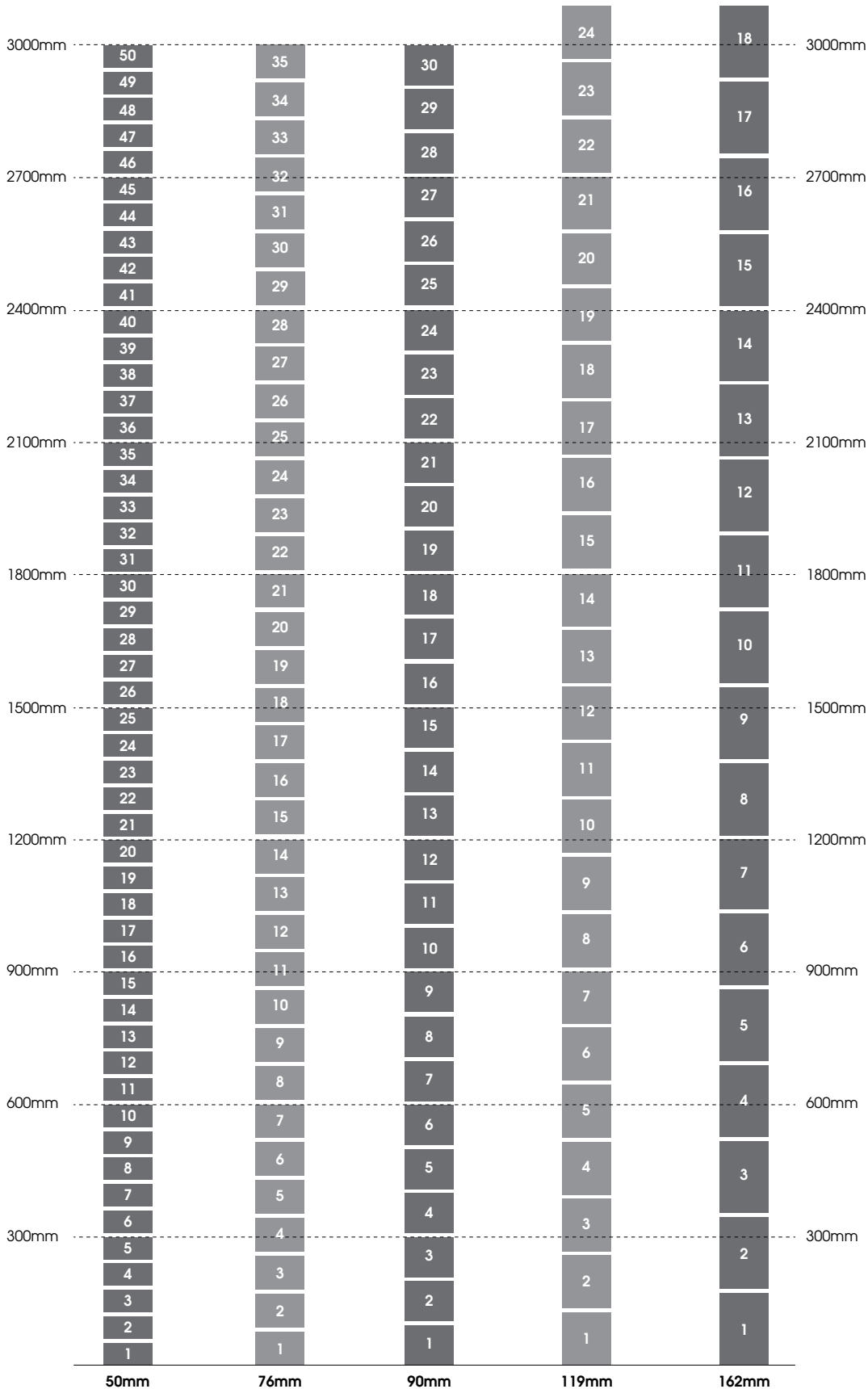

# 5.8 Brick Gauge

## 5.8.1 230mm Long Bricks

No. of Bricks	Length (mm)	Opening (mm)	No. of Bricks	Length (mm)	Opening (mm)	No. of Bricks	Length (mm)	Opening (mm)	No. of Bricks	Length (mm)	Opening (mm)
1	230	250	13½	3230	3250	26	6230	6250	38½	9230	9250
1½	350	370	14	3350	3370	26½	6350	6370	39	9350	9370
2	470	490	14½	3470	3490	27	6470	6490	39½	9470	9490
2½	590	610	15	3590	3610	27½	6590	6610	40	9590	9610
3	710	730	15½	3710	3730	28	6710	6730	40½	9710	9730
3½	830	850	16	3830	3850	28½	6830	6850	41	9830	9850
4	950	970	16½	3950	3970	29	6950	6970	41½	9950	9970
4½	1070	1090	17	4070	4090	29½	7070	7090	42	10070	10090
5	1190	1210	17½	4190	4210	30	7190	7210	42½	10190	10210
5½	1310	1330	18	4310	4330	30½	7310	7330	43	10310	10330
6	1430	1450	18½	4430	4450	31	7430	7450	43½	10430	10450
6½	1550	1570	19	4550	4570	31½	7550	7570	44	10550	10570
7	1670	1690	19½	4670	4690	32	7670	7690	44½	10670	10690
7½	1790	1810	20	4790	4810	32½	7790	7810	45	10790	10810
8	1910	1930	20½	4910	4930	33	7910	7930	45½	10910	10930
8½	2030	2050	21	5030	5050	33½	8030	8050	46	11030	11050
9	2150	2170	21½	5150	5170	34	8150	8170	46½	11150	11170
9½	2270	2290	22	5270	5290	34½	8270	8290	47	11270	11290
10	2390	2410	22½	5390	5410	35	8390	8410	47½	11390	11410
10½	2510	2530	23	5510	5530	35½	8510	8530	48	11510	11530
11	2630	2650	23½	5630	5650	36	8630	8650	48½	11630	11650
11½	2750	2770	24	5750	5770	36½	8750	8770	49	11750	11770
12	2870	2890	24½	5870	5890	37	8870	8890	49½	11870	11890
12½	2990	3010	25	5990	6010	37½	8990	9010	50	11990	12010
13	3110	3130	25½	6110	6130	38	9110	9130			

## 5.8.2 290mm Long Bricks

No. of Bricks	Length (mm)	Opening (mm)	No. of Bricks	Length (mm)	Opening (mm)	No. of Bricks	Length (mm)	Opening (mm)	No. of Bricks	Length (mm)	Opening (mm)
1	290	310	13 <sup>2</sup> / <sub>3</sub>	4090	4110	26 <sup>1</sup> / <sub>3</sub>	7890	7910	39	11690	11710
1 <sup>1</sup> / <sub>3</sub>	390	410	14	4190	4210	26 <sup>2</sup> / <sub>3</sub>	7990	8010	39 <sup>1</sup> / <sub>3</sub>	11790	11810
1 <sup>2</sup> / <sub>3</sub>	490	510	14 <sup>1</sup> / <sub>3</sub>	4290	4310	27	8090	8110	39 <sup>2</sup> / <sub>3</sub>	11890	11910
2	590	610	14 <sup>2</sup> / <sub>3</sub>	4390	4410	27 <sup>1</sup> / <sub>3</sub>	8190	8210	40	11990	12010
2 <sup>1</sup> / <sub>3</sub>	690	710	15	4490	4510	27 <sup>2</sup> / <sub>3</sub>	8290	8310	40 <sup>1</sup> / <sub>3</sub>	12090	12110
2 <sup>2</sup> / <sub>3</sub>	790	810	15 <sup>1</sup> / <sub>3</sub>	4590	4610	28	8390	8410	40 <sup>2</sup> / <sub>3</sub>	12190	12210
3	890	910	15 <sup>2</sup> / <sub>3</sub>	4690	4710	28 <sup>1</sup> / <sub>3</sub>	8490	8510	41	12290	12310
3 <sup>1</sup> / <sub>3</sub>	990	1010	16	4790	4810	28 <sup>2</sup> / <sub>3</sub>	8590	8610	41 <sup>1</sup> / <sub>3</sub>	12390	12410
3 <sup>2</sup> / <sub>3</sub>	1090	1110	16 <sup>1</sup> / <sub>3</sub>	4890	4910	29	8690	8710	41 <sup>2</sup> / <sub>3</sub>	12490	12510
4	1190	1210	16 <sup>2</sup> / <sub>3</sub>	4990	5010	29 <sup>1</sup> / <sub>3</sub>	8790	8810	42	12590	12610
4 <sup>1</sup> / <sub>3</sub>	1290	1310	17	5090	5110	29 <sup>2</sup> / <sub>3</sub>	8890	8910	42 <sup>1</sup> / <sub>3</sub>	12690	12710
4 <sup>2</sup> / <sub>3</sub>	1390	1410	17 <sup>1</sup> / <sub>3</sub>	5190	5210	30	8990	9010	42 <sup>2</sup> / <sub>3</sub>	12790	12810
5	1490	1510	17 <sup>2</sup> / <sub>3</sub>	5290	5310	30 <sup>1</sup> / <sub>3</sub>	9090	9110	43	12890	12910
5 <sup>1</sup> / <sub>3</sub>	1590	1610	18	5390	5410	30 <sup>2</sup> / <sub>3</sub>	9190	9210	43 <sup>1</sup> / <sub>3</sub>	12990	13010
5 <sup>2</sup> / <sub>3</sub>	1690	1710	18 <sup>1</sup> / <sub>3</sub>	5490	5510	31	9290	9310	43 <sup>2</sup> / <sub>3</sub>	13090	13110
6	1790	1810	18 <sup>2</sup> / <sub>3</sub>	5590	5610	31 <sup>1</sup> / <sub>3</sub>	9390	9410	44	13190	13210
6 <sup>1</sup> / <sub>3</sub>	1890	1910	19	5690	5710	31 <sup>2</sup> / <sub>3</sub>	9490	9510	44 <sup>1</sup> / <sub>3</sub>	13290	13310
6 <sup>2</sup> / <sub>3</sub>	1990	2010	19 <sup>1</sup> / <sub>3</sub>	5790	5810	32	9590	9610	44 <sup>2</sup> / <sub>3</sub>	13390	13410
7	2090	2110	19 <sup>2</sup> / <sub>3</sub>	5890	5910	32 <sup>1</sup> / <sub>3</sub>	9690	9710	45	13490	13510
7 <sup>1</sup> / <sub>3</sub>	2190	2210	20	5990	6010	32 <sup>2</sup> / <sub>3</sub>	9790	9810	45 <sup>1</sup> / <sub>3</sub>	13590	13610
7 <sup>2</sup> / <sub>3</sub>	2290	2310	20 <sup>1</sup> / <sub>3</sub>	6090	6110	33	9890	9910	45 <sup>2</sup> / <sub>3</sub>	13690	13710
8	2390	2410	20 <sup>2</sup> / <sub>3</sub>	6190	6210	33 <sup>1</sup> / <sub>3</sub>	9990	10010	46	13790	13810
8 <sup>1</sup> / <sub>3</sub>	2490	2510	21	6290	6310	33 <sup>2</sup> / <sub>3</sub>	10090	10110	46 <sup>1</sup> / <sub>3</sub>	13890	13910
8 <sup>2</sup> / <sub>3</sub>	2590	2610	21 <sup>1</sup> / <sub>3</sub>	6390	6410	34	10190	10210	46 <sup>2</sup> / <sub>3</sub>	13990	14010
9	2690	2710	21 <sup>2</sup> / <sub>3</sub>	6490	6510	34 <sup>1</sup> / <sub>3</sub>	10290	10310	47	14090	14110
9 <sup>1</sup> / <sub>3</sub>	2790	2810	22	6590	6610	34 <sup>2</sup> / <sub>3</sub>	10390	10410	47 <sup>1</sup> / <sub>3</sub>	14190	14210
9 <sup>2</sup> / <sub>3</sub>	2890	2910	22 <sup>1</sup> / <sub>3</sub>	6690	6710	35	10490	10510	47 <sup>2</sup> / <sub>3</sub>	14290	14310
10	2990	3010	22 <sup>2</sup> / <sub>3</sub>	6790	6810	35 <sup>1</sup> / <sub>3</sub>	10590	10610	48	14390	14410
10 <sup>1</sup> / <sub>3</sub>	3090	3110	23	6890	6910	35 <sup>2</sup> / <sub>3</sub>	10690	10710	48 <sup>1</sup> / <sub>3</sub>	14490	14510
10 <sup>2</sup> / <sub>3</sub>	3190	3210	23 <sup>1</sup> / <sub>3</sub>	6990	7010	36	10790	10810	48 <sup>2</sup> / <sub>3</sub>	14590	14610
11	3290	3310	23 <sup>2</sup> / <sub>3</sub>	7090	7110	36 <sup>1</sup> / <sub>3</sub>	10890	10910	49	14690	14710
11 <sup>1</sup> / <sub>3</sub>	3390	3410	24	7190	7210	36 <sup>2</sup> / <sub>3</sub>	10990	11010	49 <sup>1</sup> / <sub>3</sub>	14790	14810
11 <sup>2</sup> / <sub>3</sub>	3490	3510	24 <sup>1</sup> / <sub>3</sub>	7290	7310	37	11090	11110	49 <sup>2</sup> / <sub>3</sub>	14890	14910
12	3590	3610	24 <sup>2</sup> / <sub>3</sub>	7390	7410	37 <sup>1</sup> / <sub>3</sub>	11190	11210	50	14990	15010
12 <sup>1</sup> / <sub>3</sub>	3690	3710	25	7490	7510	37 <sup>2</sup> / <sub>3</sub>	11290	11310	100	28990	27010
12 <sup>2</sup> / <sub>3</sub>	3790	3810	25 <sup>1</sup> / <sub>3</sub>	7590	7610	38	11390	11410			
13	3890	3910	25 <sup>2</sup> / <sub>3</sub>	7690	7710	38 <sup>1</sup> / <sub>3</sub>	11490	11510			
13 <sup>1</sup> / <sub>3</sub>	3990	4010	26	7790	7810	38 <sup>2</sup> / <sub>3</sub>	11590	11610			



### 5.8.3 470mm Long Bricks

No. of Bricks	Length (mm)	Opening (mm)
1	470	490
1.5	705	735
2	940	980
2.5	1175	1225
3	1410	1470
3.5	1645	1715
4	1880	1960
4.5	2115	2205
5	2350	2450
5.5	2585	2695
6	2820	2940
6.5	3055	3185
7	3290	3430
7.5	3525	3675
8	3760	3920
8.5	3995	4165
9	4230	4410
9.5	4465	4655
10	4700	4900
10.5	4935	5145
11	5170	5390
11.5	5405	5635
12	5640	5880
12.5	5875	6125
13	6110	6370
13.5	6345	6615
14	6580	6860
14.5	6815	7105
15	7050	7350
15.5	7285	7595
16	7520	7840
16.5	7755	8085
17	7990	8330

No. of Bricks	Length (mm)	Opening (mm)
17.5	8225	8575
18	8460	8820
18.5	8695	9065
19	8930	9310
19.5	9165	9555
20	9400	9800
20.5	9635	10045
21	9870	10290
21.5	10105	10535
22	10340	10780
22.5	10575	11025
23	10810	11270
23.5	11045	11515
24	11280	11760
24.5	11515	12005
25	11750	12250
25.5	11985	12495
26	12220	12740
26.5	12455	12985
27	12690	13230
27.5	12925	13475
28	13160	13720
28.5	13395	13965
29	13630	14210
29.5	13865	14455
30	14100	14700
30.5	14335	14945
31	14570	15190
31.5	14805	15435
32	15040	15680
32.5	15275	15925
33	15510	16170
33.5	15745	16415

No. of Bricks	Length (mm)	Opening (mm)
34	15980	16660
34.5	16215	16905
35	16450	17150
35.5	16685	17395
36	16920	17640
36.5	17155	17885
37	17390	18130
37.5	17625	18375
38	17860	18620
38.5	18095	18865
39	18330	19110
39.5	18565	19355
40	18800	19600
40.5	19035	19845
41	19270	20090
41.5	19505	20335
42	19740	20580
42.5	19975	20825
43	20210	21070
43.5	20445	21315
44	20680	21560
44.5	20915	21805
45	21150	22050
45.5	21385	22295
46	21620	22540
46.5	21855	22785
47	22090	23030
47.5	22325	23275
48	22560	23520
48.5	22795	23765
49	23030	24010
49.5	23265	24255
50	23500	24500

### 5.8.4 Armaclay/Verticore Brick

Format Size            315 x 100 x 172mm  
 Manufacturing Size   305 x 90 x 162mm  
 Vertical Gauge        7 courses to 1200  
 (Bricks per m<sup>2</sup> in wall = 18.5 approx)

No. of Bricks	Length (mm)	Opening (mm)	Height (mm)	No. of Bricks	Length (mm)	Opening (mm)	Height (mm)	No. of Bricks	Length (mm)	Opening (mm)	No. of Bricks	Length (mm)	No. of Bricks	Length (mm)	No. of Bricks	Length (mm)
1	305	325	172	9½	3025	3045		18½	5760	5780	27	8495	35½	11215	44½	13950
1½	405	425		10	3140	3160	1714	18½	5869	5880	27½	8595	36	11330	44½	14050
1½	505	525		10½	3240	3260		19	5975	5995	27½	8895	36½	11430	45	14165
2	620	640	343	10½	3340	3360		19½	6075	6195	28	8810	36½	11530	45½	14265
2½	720	740		11	3455	3478	1886	19½	6175	6295	28½	8910	37	11645	45½	14365
2½	820	830		11½	3555	3575		20	6290	6310	28½	3010	37½	11745	46	14480
3	935	955	514	11½	3655	3675		20½	6390	6410	29	9125	37½	11845	46½	14580
3½	1035	1035		12	3770	3790	2057	20½	6490	6510	29½	9225	38	11960	46½	14680
3½	1135	1135		12½	3870	3890		21	6605	6625	29½	9325	38½	12060	47	14795
4	1250	1270	686	12½	3970	3990		21½	6705	6725	30	9440	38½		47½	14895
4½	1350	1370		13	4085	4105	2229	21½	6805	6825	30½	9540	39	12275	47½	15995
4½	1450	1470		13½	4185	4205		22	6920	6940	30½	9640	39½	12375	48	15110
5	1565	1585	857	13½	4285	4305		22½	7020	7040	31	9755	39½	12475	48½	15210
5½	1665	1685		14	4400	4420	2400	22½	7120	7140	31½	9855	40	12590	48½	15310
5½	1765	1785		14½	4500	4520		23	7235	7255	31½	9955	40½	12690	49	15425
6	1880	1900	1029	14½	4600	4620		23½	7335	7355	32	10070	40½	12790	49½	15525
6½	1980	2000		15	4715	4735		23½	7435	7455	32½	10170	41	12905	49½	15625
6½	2080	2100		15½	4815	4835		24	7550	7570	32½	10270	41½	13005	50	15740
7	2195	2215	1200	15½	4915	4935		24½	7650	7670	33	10385	41½	13105	100	31490
7½	2295	2315		16	5030	5050		24½	7750	7770	33½	10485	42	43220		
7½	2395	2415		16½	5130	5150		25	7865	7885	33½	10585	42½	13320		
8	2510	2530	1372	16½	5230	5250		25½	7965	7985	34	10700	42½	13420		
8½	2610	2630		17	5345	5365		25½	7965	8085	34½	10800	43	13535		
8½	2710	2730		17½	5445	5465		26	8180		34½	10900	43½	13635		
9	2825	2845	1543	17½	5345	5365		26½	8280		35	11015	43½	13735		
9½	2925	2945		18	5660	5680		26½	8380		35½	11115	44	13850		

### 5.8.5 Face Block

Format Size                300 x 100 x 172  
 Manufacturing Size      290 x 90 x 162  
 Vertical Gauge            7 courses to 1200  
 (Bricks per m2 in wall = 19.5 approx)

#### ONE THIRD BOND COURSING

No. of Bricks	Length (mm)	Opening (mm)	Height (mm)	No. of Bricks	Length (mm)	Opening (mm)	Height (mm)
1	290	310	172	8	2390	2410	1372
1 $\frac{1}{3}$	390	410		8 $\frac{1}{3}$	2490	2510	
1 $\frac{2}{3}$	490	510		8 $\frac{2}{3}$	2590	2610	
2	590	610	343	9	2690	2710	1543
2 $\frac{1}{3}$	690	710		9 $\frac{1}{3}$	2790	2810	
2 $\frac{2}{3}$	790	810		9 $\frac{2}{3}$	2890	2910	
3	890	910	514	10	2990	3010	1714
3 $\frac{1}{3}$	990	1010		10 $\frac{1}{3}$	3090	3110	
3 $\frac{2}{3}$	1090	1110		10 $\frac{2}{3}$	3190	3210	
4	1190	1210	686	11	3290	3310	1886
4 $\frac{1}{3}$	1290	1310		11 $\frac{1}{3}$	3390	3410	
4 $\frac{2}{3}$	1390	1410		11 $\frac{2}{3}$	3490	3510	
5	1490	1510	857	12	3590	3610	2057
5 $\frac{1}{3}$	1590	1610		12 $\frac{1}{3}$	3690	3710	
5 $\frac{2}{3}$	1690	1710		12 $\frac{2}{3}$	3790	3810	
6	1790	1810	1029	13	3890	3910	2229
6 $\frac{1}{3}$	1890	1910		13 $\frac{1}{3}$	3990	4010	
6 $\frac{2}{3}$	1990	2010		13 $\frac{2}{3}$	4090	4110	
7	2090	2110	1200	14	4190	4210	2400
7 $\frac{1}{3}$	2190	2210		14 $\frac{1}{3}$	4290	4310	
7 $\frac{2}{3}$	2290	2310					

### 5.8.6 Peninsula Brick

Format Size                300 x 100 x 172mm  
 Manufacturing Size      290 x 90 x 162mm  
 Vertical Gauge            7 courses to 1200  
 (Bricks per m<sup>2</sup> in wall = 19.5 approx)

#### HALF BOND COURSING

No. of Bricks	Corner Pier to Opening	Overall Pier	Pier	Wall	Opening	No. of Bricks	Vertical	No. of Bricks	Corner Pier to Opening	Overall Pier	Pier	Wall	Opening	No. of Bricks	Vertical
1	240	340	290	300	310	1	172	14	4140	4240	4190	4200	4210	27	4629
1½	390	490	440	450	460	2	343	14½	4290	4390	4340	4350	4360	28	4800
2	540	640	590	600	610	3	514	15	4440	4540	4490	4500	4510	29	4972
2½	690	790	740	750	760	4	686	15½	4590	4690	4640	4650	4660	30	5143
3	840	940	890	900	910	5	857	16	4740	4840	4790	4800	4810		
3½	990	1090	1040	1050	1060	6	1029	16½	4890	4990	4940	4950	4960		
4	1140	1240	1190	1200	1210	7	1200	17	5040	5140	5090	5100	5110		
4½	1290	1390	1340	1350	1360	8	1372	17½	5190	5290	5240	5250	5260		
5	1440	1540	1490	1500	1510	9	1543	18	5340	5440	5390	5400	5410		
5½	1590	1690	1640	1650	1660	10	1714	18½	5490	5590	5540	5550	5560		
6	1740	1840	1790	1800	1810	11	1886	19	5640	5740	5690	5700	5710		
6½	1890	1990	1940	1950	1960	12	2057	19½	5790	5890	5840	5850	5860		
7	2040	2140	2090	2100	2110	13	2229	20	5940	6040	5990	6000	6010		
7½	2190	2290	2240	2250	2260	14	2400	20½	6090	6190	6140	6150	6160		
8	2340	2440	2390	2400	2410	15	2572	21	6240	6340	6290	6300	6310		
8½	2790	2590	2540	2550	2560	16	2743	21½	6390	6490	6440	6450	6460		
9	2640	2740	2690	2700	2710	17	2914	22	6540	6640	6590	6600	6610		
9½	2790	2890	2840	2850	2860	18	3086	22½	6690	6760	6740	6750	6760		
10	2940	3040	2990	3000	3010	19	3257	23	6840	6940	6890	6900	6910		
10½	3090	3190	3140	3150	3160	20	3429	23½	6990	7090	7040	7050	7060		
11	3240	3340	3290	3300	3310	21	3600	24	7140	7240	7190	7200	7210		
11½	3390	3490	3440	3450	3460	22	3772	24½	7290	7390	7340	7350	7360		
12	3540	3640	3590	3600	3610	23	3843	25	7440	7540	7490	7500	7510		
12½	3690	3790	3740	3750	3760	24	4114	25½	7590	7690	7640	7650	7660		
13	3840	3940	3890	3900	3910	25	4286	26	7740	7840	7790	7800	7810		
13½	3990	4090	4040	4050	4060	26	4457								

### Peninsula

#### Corner Pier to Opening

- Is a brick run starting with a 240mm cut
- The 240mm cut is considered as one brick in the 'No. Bricks' column.
- 1/2 brick represents 140mm cut brick

**Note:** Cnr pier to opening refers to a 240mm cut being used on every course on every corner and the use of 140mm cuts for openings to maintain 1/2 bond.

#### Overall Opening

Is the same calculation as cnr pier, but it includes 100mm which is including a 90mm header return and 10mm mortar joint.

### Modular 76

If building with Modular 76 bricks, use height dimensions from Standard brick chart. For length dimensions, use Armaclay/Verticore brick chart. (Bricks per m<sup>2</sup> in wall = 37 approx)

# WE ARE

## *Brickworks*

Brickworks Building Products is one of Australia's largest and most diverse building material manufacturers. Under the Brickworks Building Products umbrella are some of Australia's best known building materials brands. Our products include bricks, pavers, masonry blocks, retaining wall systems, precast concrete panels, concrete and terracotta roof tiles, timber products, terracotta façades and specialised building systems.

With a broad product portfolio and manufacturing and sales facilities across Australia, Brickworks Building Products is uniquely placed to service the demands of the building industry.

With over 1200 staff across Australia and New Zealand, we pride ourselves on our commitment to product, service excellence and our leadership position.

### **BRICKWORKS** — BUILDING PRODUCTS —

 australbricks®

 australmasonry®

 australprecast®

 auswesttimbers®

 bristileroofting®

 BOWRAL BRICKS

 nubrik®  
authentic brickwork



 terraçade™  
TERRACOTTA FAÇADE SYSTEMS

 INEX BOARDS™

Pronto Panel™

Proud Supporters



# BRICKWORKS

— BUILDING PRODUCTS —

[brickworksbuildingproducts.com.au](http://brickworksbuildingproducts.com.au) | 13-brick

follow brickworks building products on



## DESIGN STUDIOS

### Sydney CBD

Ground Floor  
50 Carrington  
Street, Sydney  
NSW 2000

### Melbourne

490 Swan Street  
Richmond  
VIC 3121

### Adelaide

Ground Floor  
70 Hindmarsh  
Square, Adelaide  
SA 5000

### Brisbane

27 James Street  
Fortitude Valley  
QLD 4006

### Perth

67 King Street  
Perth  
WA 6000

### Hobart

9 Franklin Wharf  
Hobart  
TAS 7000