

## Ultrafast recovery diode

### Features

- Very low conduction losses
- Negligible switching losses
- Low forward and reverse recovery times
- High junction temperature

### Description

The STTH4R02 uses ST's new 200 V planar Pt doping technology, and it is specially suited for switching mode base drive and transistor circuits.

Packaged in TO-220AC, TO-220FPAC, DPAK, SMB, SMC, and DO-201AB, this device is intended for use in low voltage, high frequency inverters, free wheeling and polarity protection.

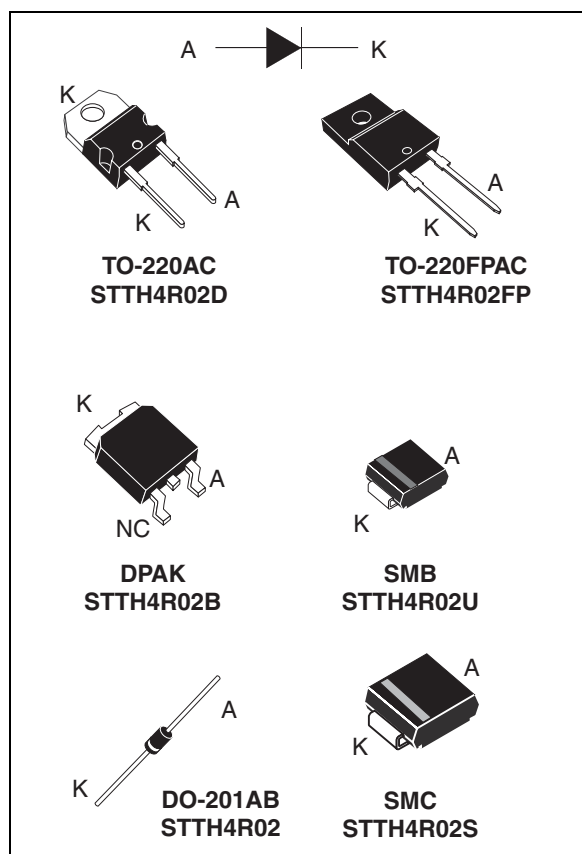

**Table 1. Device summary**

$I_{F(AV)}$	4 A
$V_{RRM}$	200 V
$T_j (max)$	175 °C
$V_F (typ)$	0.76 V
$t_{rr} (typ)$	16 ns

# 1 Characteristics

**Table 2. Absolute ratings (limiting values at  $T_j = 25\text{ °C}$ , unless otherwise specified)**

Symbol	Parameter		Value	Unit	
$V_{RRM}$	Repetitive peak reverse voltage		200	V	
$I_{F(RMS)}$	Forward rms current	TO-220AC	70	A	
		DPAK			
		SMB / SMC			
		TO-220FPAC			
		DO-201AB			
$I_{F(AV)}$	Average forward current, $\delta = 0.5$	TO-220AC	4	A	
		DPAK			$T_c = 160\text{ °C}$
		SMB			$T_c = 95\text{ °C}$
		SMC			$T_c = 95\text{ °C}$
		TO-220FPAC			$T_c = 150\text{ °C}$
		DO-201AB			$T_{lead} = 95\text{ °C}$
$I_{FSM}$	Surge non repetitive forward current	$t_p = 10\text{ ms sinusoidal}$	70	A	
$T_{stg}$	Storage temperature range		-65 to + 175	°C	
$T_j$	Maximum operating junction temperature		175	°C	

**Table 3. Thermal parameters**

Symbol	Parameter		Value	Unit
$R_{th(j-c)}$	Junction to case	TO-220AC / DPAK	3.5	°C/W
		SMB	20	
		TO-220FPAC	6.5	
		DO-201AB	20	
		SMC	20	

**Table 4. Static electrical characteristics**

Symbol	Parameter	Test conditions	Min.	Typ.	Max.	Unit	
$I_R^{(1)}$	Reverse leakage current	$T_j = 25\text{ }^\circ\text{C}$	$V_R = V_{RRM}$		3	$\mu\text{A}$	
		$T_j = 125\text{ }^\circ\text{C}$			20		
$V_F^{(2)}$	Forward voltage drop	$T_j = 25\text{ }^\circ\text{C}$	$I_F = 12\text{ A}$		1.15	1.25	V
		$T_j = 25\text{ }^\circ\text{C}$	$I_F = 4\text{ A}$		0.95	1.05	
		$T_j = 150\text{ }^\circ\text{C}$			0.76	0.83	

1. Pulse test:  $t_p = 5\text{ ms}$ ,  $\delta < 2\%$
2. Pulse test:  $t_p = 380\text{ }\mu\text{s}$ ,  $\delta < 2\%$

To evaluate the conduction losses use the following equation:

$$P = 0.67 \times I_{F(AV)} + 0.04 I_{F(RMS)}^2$$

**Table 5. Dynamic characteristics**

Symbol	Parameter	Test conditions	Min.	Typ.	Max.	Unit
$t_{rr}$	Reverse recovery time	$I_F = 1\text{ A}$ , $di_F/dt = -50\text{ A}/\mu\text{s}$ , $V_R = 30\text{ V}$ , $T_j = 25\text{ }^\circ\text{C}$		24	30	ns
		$I_F = 1\text{ A}$ , $di_F/dt = -100\text{ A}/\mu\text{s}$ , $V_R = 30\text{ V}$ , $T_j = 25\text{ }^\circ\text{C}$		16	20	
$I_{RM}$	Reverse recovery current	$I_F = 4\text{ A}$ , $di_F/dt = -200\text{ A}/\mu\text{s}$ , $V_R = 160\text{ V}$ , $T_j = 125\text{ }^\circ\text{C}$		4.4	5.5	A
$t_{fr}$	Forward recovery time	$I_F = 4\text{ A}$ , $di_F/dt = 50\text{ A}/\mu\text{s}$ $V_{FR} = 1.1 \times V_{Fmax}$ , $T_j = 25\text{ }^\circ\text{C}$		80		ns
$V_{FP}$	Forward recovery voltage	$I_F = 4\text{ A}$ , $di_F/dt = 50\text{ A}/\mu\text{s}$ , $T_j = 25\text{ }^\circ\text{C}$		1.6		V

**Figure 1. Peak current versus duty cycle**

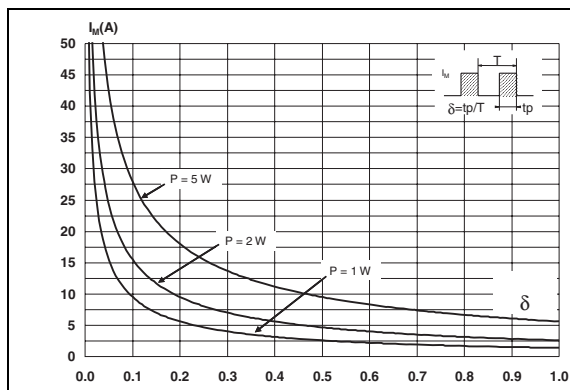

**Figure 2. Forward voltage drop versus forward current (typical values)**

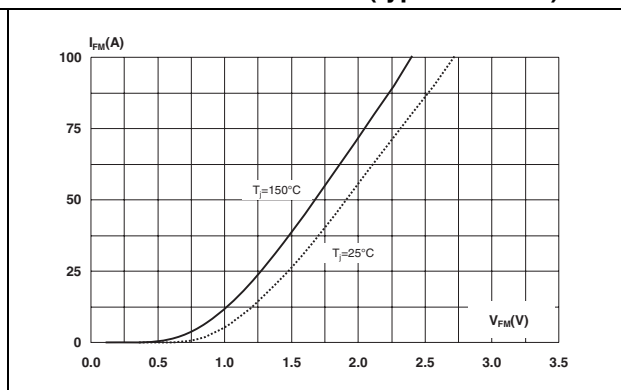

**Figure 3. Forward voltage drop versus forward current (maximum values)**

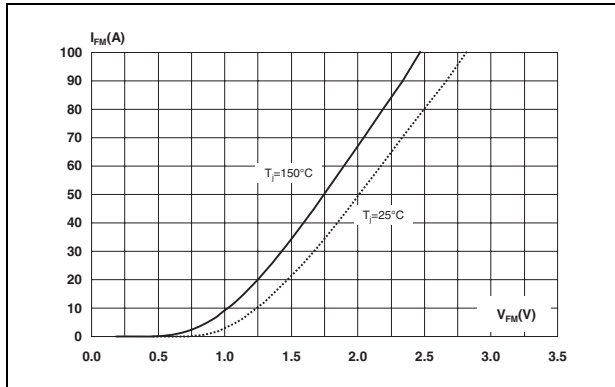

**Figure 4. Relative variation of thermal impedance, junction to case, versus pulse duration**

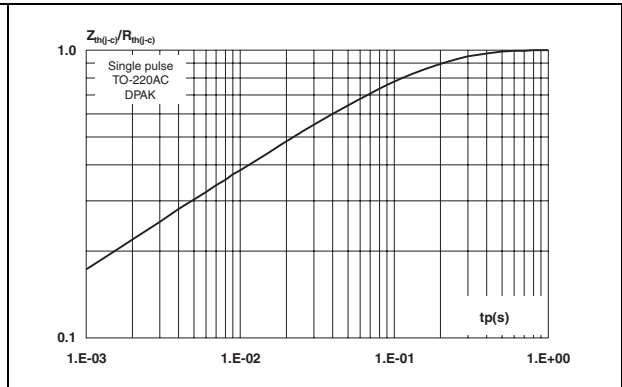

**Figure 5. Relative variation of thermal impedance, junction to case, versus pulse duration**

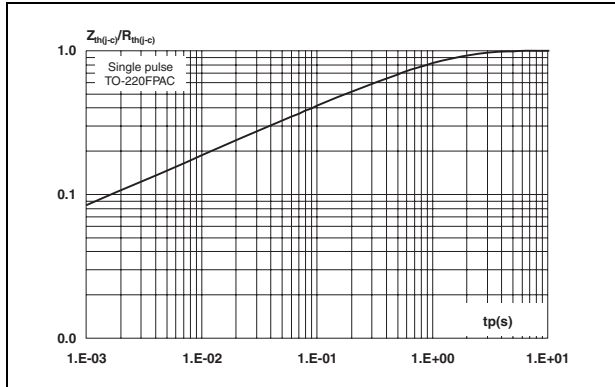

**Figure 6. Relative variation of thermal impedance, junction to ambient, versus pulse duration (SMB)**

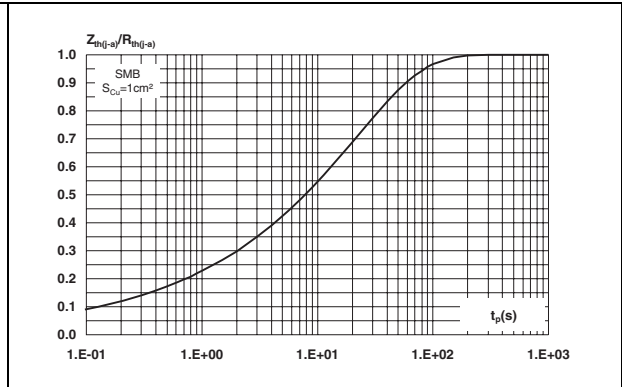

**Figure 7. Relative variation of thermal impedance, junction to ambient, versus pulse duration**

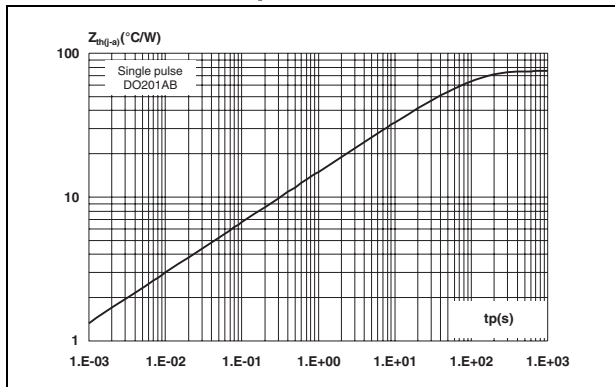

**Figure 8. Relative variation of thermal impedance, junction to ambient, versus pulse duration (SMC)**

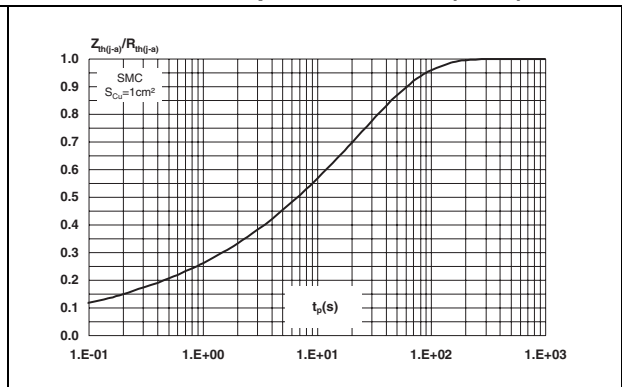

Figure 9. Junction capacitance versus reverse applied voltage (typical values)

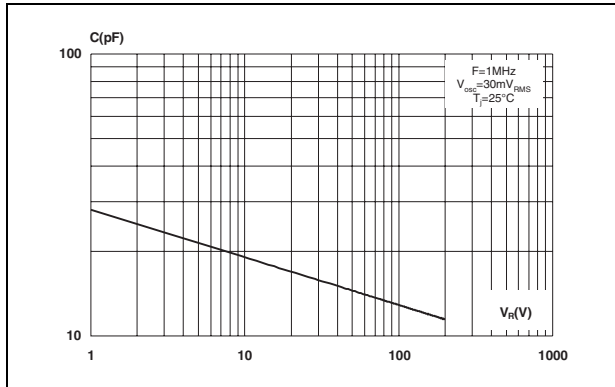

Figure 10. Reverse recovery charges versus  $di_F/dt$  (typical values)

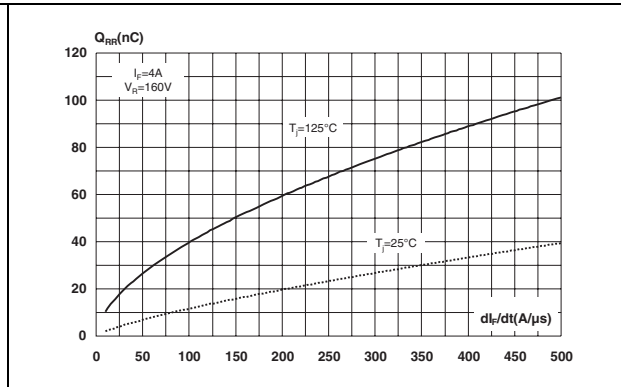

Figure 11. Reverse recovery time versus  $di_F/dt$  (typical values)

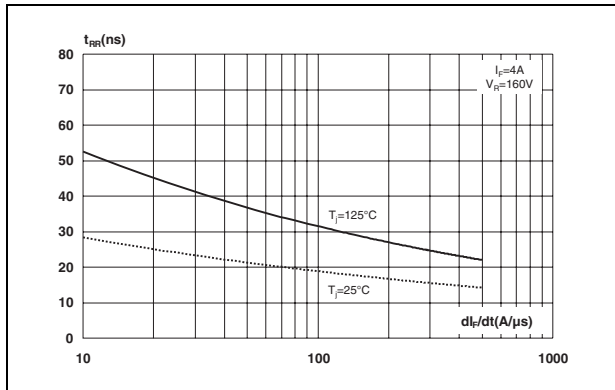

Figure 12. Peak reverse recovery current versus  $di_F/dt$  (typical values)

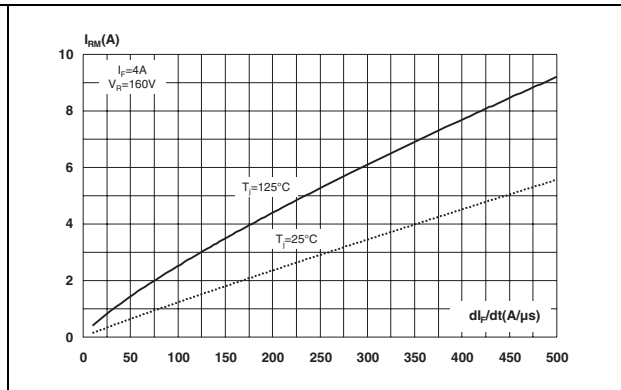

Figure 13. Dynamic parameters versus junction temperature

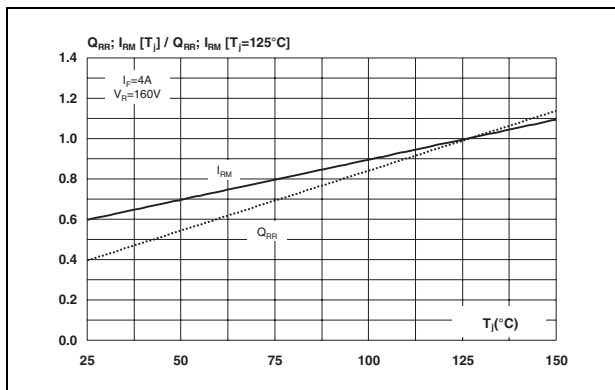

Figure 14. Thermal resistance, junction to ambient, versus copper surface under tab - DPAK

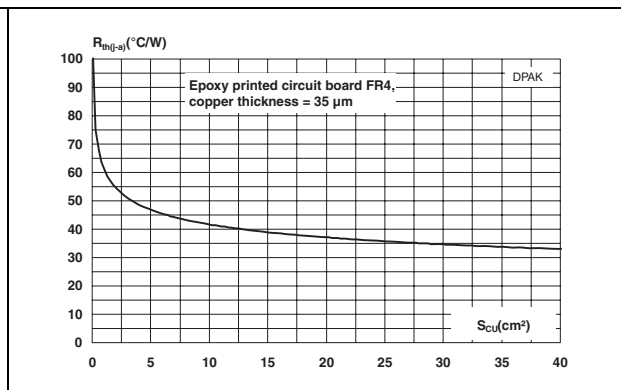

Figure 15. Thermal resistance, junction to ambient, versus copper surface under tab - SMB

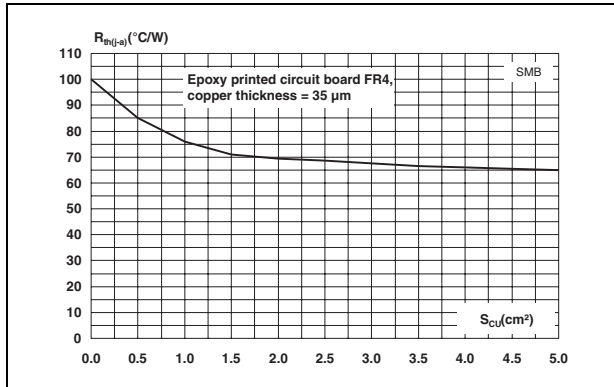

Figure 16. Thermal resistance, junction to ambient, versus copper surface under tab - SMC

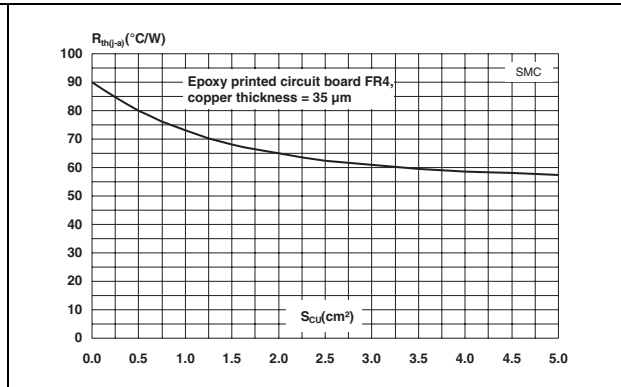
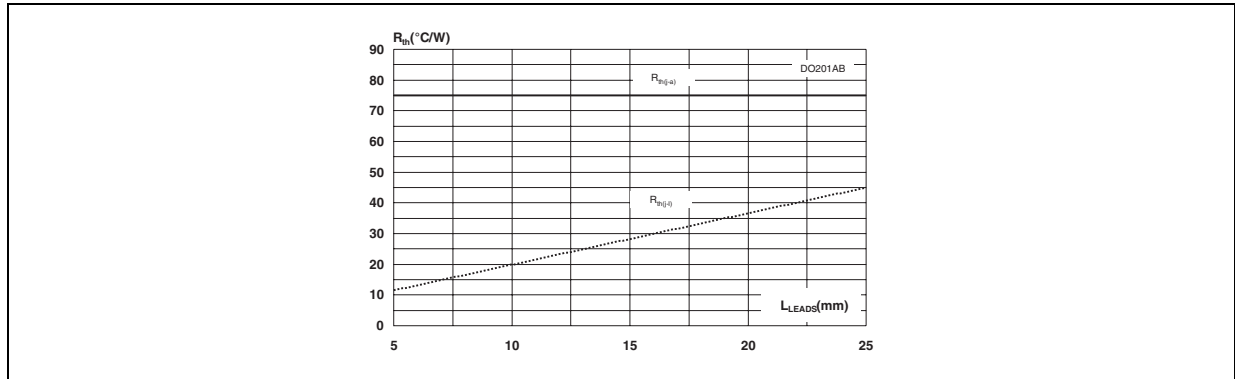
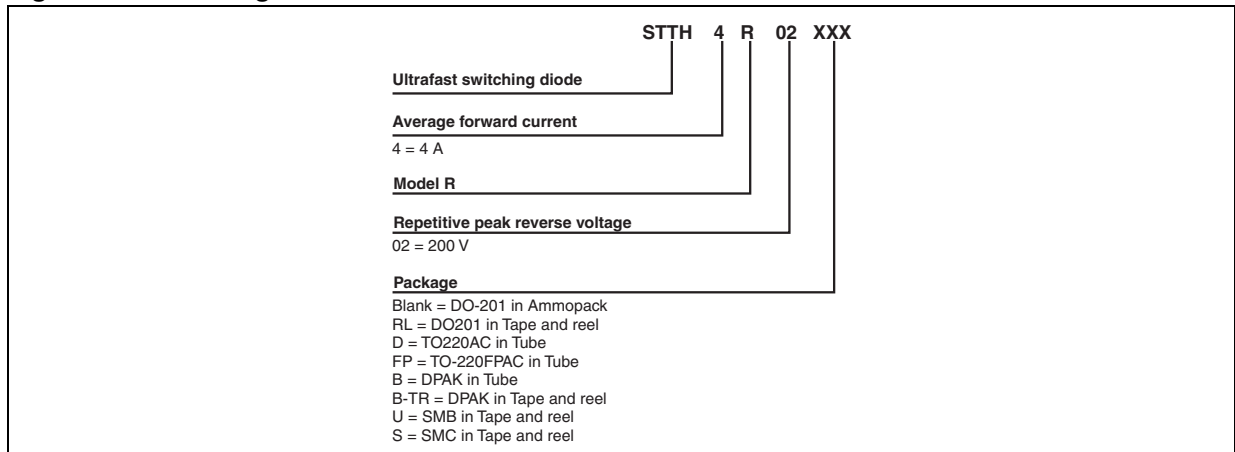

Figure 17. Thermal resistance versus lead length - DO-201AB



## 2 Ordering information scheme

Figure 18. Ordering information scheme



### 3 Package information

- Epoxy meets UL94, V0
- Cooling method: by conduction (C)
- Recommended torque value: 0.4 to 0.6 N·m

In order to meet environmental requirements, ST offers these devices in different grades of ECOPACK® packages, depending on their level of environmental compliance. ECOPACK® specifications, grade definitions and product status are available at: [www.st.com](http://www.st.com). ECOPACK® is an ST trademark.

**Table 6. T0-220AC dimensions**

Ref.	Dimensions			
	Millimeters		Inches	
	Min.	Max.	Min.	Max.
A	4.40	4.60	0.173	0.181
C	1.23	1.32	0.048	0.051
D	2.40	2.72	0.094	0.107
E	0.49	0.70	0.019	0.027
F	0.61	0.88	0.024	0.034
F1	1.14	1.70	0.044	0.066
G	4.95	5.15	0.194	0.202
H2	10.00	10.40	0.393	0.409
L2	16.40 typ.		0.645 typ.	
L4	13.00	14.00	0.511	0.551
L5	2.65	2.95	0.104	0.116
L6	15.25	15.75	0.600	0.620
L7	6.20	6.60	0.244	0.259
L9	3.50	3.93	0.137	0.154
M	2.6 typ.		0.102 typ.	
Diam. I	3.75	3.85	0.147	0.151

**Table 7. DPAK dimensions**

Ref.	Dimensions			
	Millimeters		Inches	
	Min.	Max	Min.	Max.
A	2.20	2.40	0.086	0.094
A1	0.90	1.10	0.035	0.043
A2	0.03	0.23	0.001	0.009
B	0.64	0.90	0.025	0.035
B2	5.20	5.40	0.204	0.212
C	0.45	0.60	0.017	0.023
C2	0.48	0.60	0.018	0.023
D	6.00	6.20	0.236	0.244
E	6.40	6.60	0.251	0.259
G	4.40	4.60	0.173	0.181
H	9.35	10.10	0.368	0.397
L2	0.80 typ.		0.031 typ.	
L4	0.60	1.00	0.023	0.039
V2	0°	8°	0°	8°

**Figure 19. DPAK footprint**

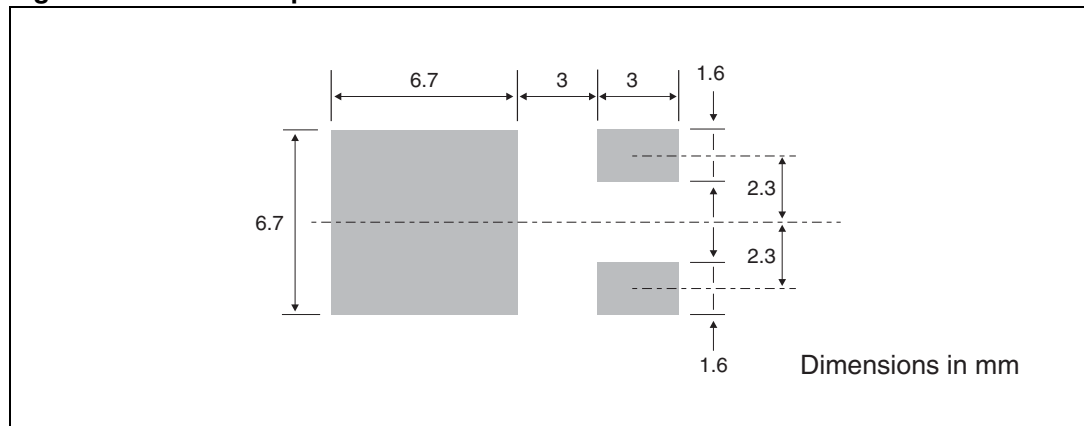



Table 8. T0-220FPAC dimensions

Ref.	Dimensions			
	Millimeters		Inches	
	Min.	Max.	Min.	Max.
A	4.4	4.6	0.173	0.181
B	2.5	2.7	0.098	0.106
D	2.5	2.75	0.098	0.108
E	0.45	0.70	0.018	0.027
F	0.75	1	0.030	0.039
F1	1.15	1.70	0.045	0.067
G	4.95	5.20	0.195	0.205
G1	2.4	2.7	0.094	0.106
H	10	10.4	0.393	0.409
L2	16 Typ.		0.63 Typ.	
L3	28.6	30.6	1.126	1.205
L4	9.8	10.6	0.386	0.417
L5	2.9	3.6	0.114	0.142
L6	15.9	16.4	0.626	0.646
L7	9.00	9.30	0.354	0.366
Dia.	3.00	3.20	0.118	0.126

**Table 9. SMB dimensions**

Ref.	Dimensions			
	Millimeters		Inches	
	Min.	Max.	Min.	Max.
A1	1.90	2.45	0.075	0.096
A2	0.05	0.20	0.002	0.008
b	1.95	2.20	0.077	0.087
c	0.15	0.40	0.006	0.016
D	3.30	3.95	0.130	0.156
E	5.10	5.60	0.201	0.220
E1	4.05	4.60	0.159	0.181
L	0.75	1.50	0.030	0.059

**Figure 20. Footprint, dimensions in mm (inches)**

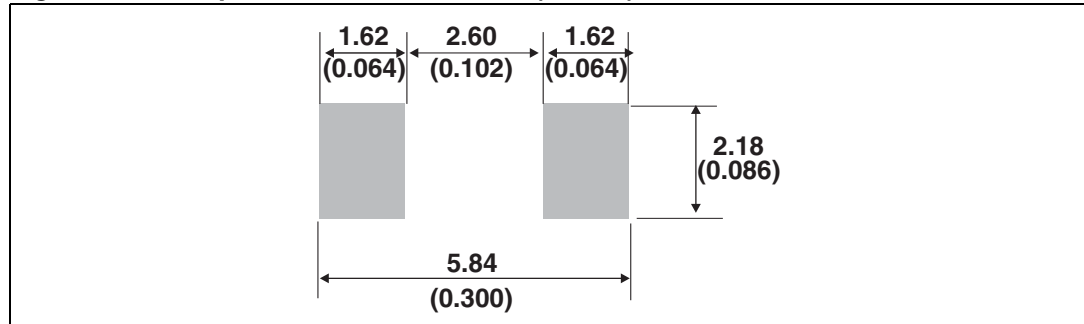
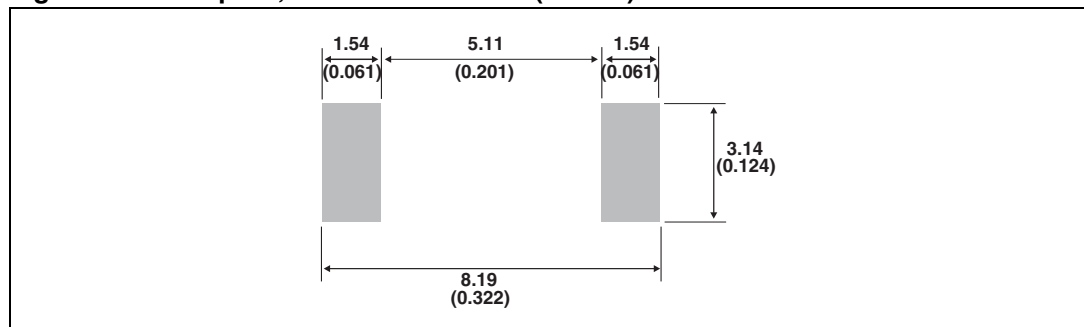

**Table 10. SMC dimensions**

Ref.	Dimensions			
	Millimeters		Inches	
	Min.	Max.	Min.	Max.
A1	1.90	2.45	0.075	0.096
A2	0.05	0.20	0.002	0.008
b <sup>(1)</sup>	2.90	3.20	0.114	0.126
c <sup>(1)</sup>	0.15	0.40	0.006	0.016
D	5.55	6.25	0.218	0.246
E	7.75	8.15	0.305	0.321
E1	6.60	7.15	0.260	0.281
E2	4.40	4.70	0.173	0.185
L	0.75	1.50	0.030	0.059

1. Dimensions b and c apply to plated leads

**Figure 21. Footprint, dimensions in mm (inches)**



**Table 11. DO-201AB dimensions**

Ref.	Dimensions			
	Millimeters		Inches	
	Min.	Max.	Min.	Max.
A	8.5	9.5	0.335	0.374
B	25.4		1	
Ø C	4.8	5.3	0.189	0.209
Ø D	0.96	1.06	0.038	0.042

## 4 Ordering information

**Table 12. Ordering information**

Order code	Marking	Package	Weight	Base qty	Delivery mode
STTH4R02D	STTH4R02	TO-220AC	1.86 g	50	Tube
STTH4R02FP	STTH4R02	TO-220FPAC	2.2 g	50	Tube
STTH4R02B	STTH4R02	DPAK	0.30 g	75	Tube
STTH4R02B-TR	STTH4R02	DPAK	0.30 g	2500	Tape and reel
STTH4R02U	4R2U	SMB	0.107 g	2500	Tape and reel
STTH4R02	STTH4R02	DO-201AB	0.876 g	600	Ammopack
STTH4R02RL	STTH4R02	DO-201AB	0.876 g	1900	Tape and reel
STTH4R02S	4R2S	SMC	0.243 g	2500	Tape and reel

## 5 Revision history

**Table 13. Document revision history**

Date	Revision	Changes
03-May-2006	1	First issue.
10-Oct-2006	2	Added SMC package
13-Apr-2010	3	Updated ECOPACK statement. Updated dimensions tables for SMB and SMC.

**Please Read Carefully:**

Information in this document is provided solely in connection with ST products. STMicroelectronics NV and its subsidiaries ("ST") reserve the right to make changes, corrections, modifications or improvements, to this document, and the products and services described herein at any time, without notice.

All ST products are sold pursuant to ST's terms and conditions of sale.

Purchasers are solely responsible for the choice, selection and use of the ST products and services described herein, and ST assumes no liability whatsoever relating to the choice, selection or use of the ST products and services described herein.

No license, express or implied, by estoppel or otherwise, to any intellectual property rights is granted under this document. If any part of this document refers to any third party products or services it shall not be deemed a license grant by ST for the use of such third party products or services, or any intellectual property contained therein or considered as a warranty covering the use in any manner whatsoever of such third party products or services or any intellectual property contained therein.

**UNLESS OTHERWISE SET FORTH IN ST'S TERMS AND CONDITIONS OF SALE ST DISCLAIMS ANY EXPRESS OR IMPLIED WARRANTY WITH RESPECT TO THE USE AND/OR SALE OF ST PRODUCTS INCLUDING WITHOUT LIMITATION IMPLIED WARRANTIES OF MERCHANTABILITY, FITNESS FOR A PARTICULAR PURPOSE (AND THEIR EQUIVALENTS UNDER THE LAWS OF ANY JURISDICTION), OR INFRINGEMENT OF ANY PATENT, COPYRIGHT OR OTHER INTELLECTUAL PROPERTY RIGHT.**

**UNLESS EXPRESSLY APPROVED IN WRITING BY AN AUTHORIZED ST REPRESENTATIVE, ST PRODUCTS ARE NOT RECOMMENDED, AUTHORIZED OR WARRANTED FOR USE IN MILITARY, AIR CRAFT, SPACE, LIFE SAVING, OR LIFE SUSTAINING APPLICATIONS, NOR IN PRODUCTS OR SYSTEMS WHERE FAILURE OR MALFUNCTION MAY RESULT IN PERSONAL INJURY, DEATH, OR SEVERE PROPERTY OR ENVIRONMENTAL DAMAGE. ST PRODUCTS WHICH ARE NOT SPECIFIED AS "AUTOMOTIVE GRADE" MAY ONLY BE USED IN AUTOMOTIVE APPLICATIONS AT USER'S OWN RISK.**

Resale of ST products with provisions different from the statements and/or technical features set forth in this document shall immediately void any warranty granted by ST for the ST product or service described herein and shall not create or extend in any manner whatsoever, any liability of ST.

ST and the ST logo are trademarks or registered trademarks of ST in various countries.

Information in this document supersedes and replaces all information previously supplied.

The ST logo is a registered trademark of STMicroelectronics. All other names are the property of their respective owners.

© 2010 STMicroelectronics - All rights reserved

STMicroelectronics group of companies

Australia - Belgium - Brazil - Canada - China - Czech Republic - Finland - France - Germany - Hong Kong - India - Israel - Italy - Japan - Malaysia - Malta - Morocco - Philippines - Singapore - Spain - Sweden - Switzerland - United Kingdom - United States of America

[www.st.com](http://www.st.com)