



**Scientific Committee on Health, Environmental and Emerging Risks  
SCHEER**

**Opinion on  
Potential risks to human health of Light Emitting Diodes (LEDs)**



The SCHEER adopted this Opinion during its 9<sup>th</sup> plenary meeting on 5-6 June 2018

**ABSTRACT**

Following a request from the European Commission, the Scientific Committee on Health, Environmental and Emerging Risks (SCHEER) reviewed recent evidence to assess potential risks to human health posed by Light Emitting Diodes (LEDs) emissions.

The review of the published research conducted by the SCHEER has led to valuable conclusions and identified certain gaps in knowledge on potential risks to human health from LEDs.

The Committee concluded that there is no evidence of direct adverse health effects from LEDs emission in normal use (lamps and displays) by the general healthy population. There is some evidence that exposure to light in the late evening, including that from LED lighting and/or screens, may have an impact on the circadian rhythm. At the moment, it is not yet clear if this disturbance of the circadian system leads to adverse health effects.

Vulnerable and susceptible populations (young children, adolescents and elderly people) have been considered separately. Children have a higher sensitivity to blue light and although emissions may not be harmful, blue LEDs (between 400 nm and 500 nm) including those in toys may be very dazzling and may induce photochemical retinopathy, which is a concern especially for children below three years of age. Older people may experience discomfort from exposure to light that is rich in blue light.

Although there are cellular and animal studies showing adverse effects raising concerns, particularly in susceptible populations, their conclusions derive from results obtained either using exposure conditions that are difficult to relate to human exposures or using exposure levels greater than those likely to be achieved with LED lighting systems in practice.

Some LEDs present potential health concerns due to temporal light modulation (flicker) at frequencies of 100 Hz and above.

Reliable information on the dose-response relationship for adverse health effects for the healthy general public is not available in the scientific literature for all wavelengths emitted by LED devices.

Since the use of LED technology is still evolving, the Committee considers that it is important to closely monitor the risk of adverse health effects from long-term LED use by the general population.

**Key words:** Light Emitting Diodes (LEDs), risk assessment, health effects, SCHEER

**Opinion to be cited as:**

SCHEER (Scientific Committee on Health, Environmental and Emerging Risks), Opinion on Potential risks to human health of Light Emitting Diodes (LEDs), 6 June 2018.

## **ACKNOWLEDGMENTS**

Members of the Working Group are acknowledged for their valuable contribution to this Opinion. The members of the Working Group are:

### SCHEER

Rodica Mariana Ion  
Ana Proykova (Chair)  
Theodoros Samaras

### External experts:

Ellen Bruzell  
Jean-François Doré  
Massimo Nicolò  
John O'Hagan (Rapporteur)  
Celia Sánchez-Ramos  
Linda van Kerkhof

All Declarations of Working Group members and supporting experts are available on the following webpage:

[http://ec.europa.eu/health/scientific\\_committees/experts/declarations/scheer\\_wg\\_en](http://ec.europa.eu/health/scientific_committees/experts/declarations/scheer_wg_en)

**About the Scientific Committees (2016-2021)**

Two independent non-food Scientific Committees provide the Commission with the scientific advice it needs when preparing policy and proposals relating to consumer safety, public health and the environment. The Committees also draw the Commission's attention to the new or emerging problems that may pose an actual or potential threat.

These committees are the Scientific Committee on Consumer Safety (SCCS) and the Scientific Committee on Health, Environmental and Emerging Risks (SCHEER). The Scientific Committees review and evaluate relevant scientific data and assess potential risks. Each Committee has top independent scientists from all over the world who are committed to work in the public interest.

In addition, the Commission relies upon the work of other Union bodies, such as the European Food Safety Authority (EFSA), the European Medicines Agency (EMA), the European Centre for Disease prevention and Control (ECDC) and the European Chemicals Agency (ECHA).

**SCHEER**

This Committee, on request of Commission services, provides Opinions on questions concerning health, environmental and emerging risks. The Committees addresses questions on:

- health and environmental risks related to pollutants in the environmental media and other biological and physical factors in relation to air quality, water, waste and soils.
- complex or multidisciplinary issues requiring a comprehensive assessment of risks to consumer safety or public health, for example antimicrobial resistance, nanotechnologies, medical devices and physical hazards such as noise and electromagnetic fields.

**SCHEER members**

Roberto Bertollini, Teresa Borges, Wim de Jong, Pim de Voogt, Raquel Duarte-Davidson, Peter Hoet, Rodica Mariana Ion, Renate Kraetke, Demosthenes Panagiotakos, Ana Proykova, Theo Samaras, Marian Scott, Remy Slama, Emanuela Testai, Theo Vermeire, Marco Vighi, Sergej Zacharov

**Contact:**

European Commission  
 DG Health and Food Safety  
 Directorate C: Public Health, Country Knowledge, Crisis management  
 Unit C2 – Country Knowledge and Scientific Committees  
 Office: HTC 03/073 L-2920 Luxembourg  
[SANTE-C2-SCHEER@ec.europa.eu](mailto:SANTE-C2-SCHEER@ec.europa.eu)

© European Union, 2018

ISSN 1831-  
 doi:10.2772/

ISBN 978-92-79-  
 ND

The Opinions of the Scientific Committees present the views of the independent scientists who are members of the committees. They do not necessarily reflect the views of the European Commission. The Opinions are published by the European Commission in their original language only.

To learn more about the Scientific Committees, please visit  
[http://ec.europa.eu/health/scientific\\_committees/index\\_en.htm](http://ec.europa.eu/health/scientific_committees/index_en.htm)

## Table of Contents

ABSTRACT .....	2
ACKNOWLEDGMENTS .....	3
1. SUMMARY .....	7
2. MANDATE FROM THE EU COMMISSION SERVICES .....	10
2.1 Background .....	10
2.2 Terms of Reference (ToR).....	11
3. OPINION.....	12
4. MINORITY OPINIONS .....	16
5. DATA AND METHODOLOGY .....	17
5.1 Data/Evidence.....	17
5.2 Methodology .....	18
6. ASSESSMENT .....	20
6.1. Photometry and radiometry .....	20
6.2 Physical characteristics of LEDs sources .....	21
6.3 Point source vs diffuse source.....	22
6.4. The interaction between light and matter .....	23
6.5. Eye optics fundamentals.....	23
6.5.1 Thermal and photochemical aspects .....	24
6.5.2. The effects on the healthy eyes .....	25
6.5.2.1. Computer Vision Syndrome .....	25
6.5.2.2 Anterior Segment of the Eye.....	26
6.5.2.3 Posterior Segment of the Eye.....	26
6.5.3 Potential effects on the non-healthy eyes .....	28
6.5.4. Vulnerable and susceptible populations .....	28
6.5.4.1. Children.....	28
6.5.4.2. Adolescent .....	28
6.5.4.3. Elderly population .....	28
6.7 Optical radiation effects on skin .....	32
6.7.2 Effects of LED reported in the literature (photodermatoses) .....	33
6.7.2.2 Case reports.....	34
6.7.3 Conclusions.....	34
6.8 Circadian rhythms .....	34
6.8.1 Synchronisation and regulation of the circadian rhythm by light.....	34
6.8.3 Influence by optical radiation including LEDs.....	35
6.8.3.1 Disturbance of the circadian rhythm by LEDs sources .....	35
6.8.4 Consequences of disturbance of the circadian rhythm by light .....	37
6.8.5 Vulnerable and susceptible populations .....	37
6.8.6 Conclusions.....	38
6.9 Temporal Light Modulation (Flicker) and potential health effects .....	38

6.9.1 Conclusion .....40

6.10 Exposure and health risk scenarios.....40

6.11 Overall conclusion:.....41

7. RECOMMENDATIONS FOR FUTURE WORK .....42

8. CONSIDERATION OF THE RESPONSES RECEIVED DURING THE CONSULTATION PROCESS.....43

9. REFERENCES .....44

10. GLOSSARY OF TERMS .....55

11. LIST OF ABBREVIATIONS.....60

ANNEX I LED Technologies.....64

ANNEX II The interaction between light and matter.....69

ANNEX III Structure of the skin, Fitzpatrick skin type and optical radiation effects on skin .....72

ANNEX IV Photometry, Radiometry and Dosimetry .....87

ANNEX V Circadian rhythm.....89

ANNEX VI Hazardous waste due to the materials used for producing Light-Emitting Diodes (LEDs) .....92

ANNEX VII: Literature review.....93

## 1. SUMMARY

The purpose of the present SCHEER Opinion requested by the European Commission is to assess the potential health hazards associated with LED emissions in the general population due to LED usage.

The eye and skin are the most susceptible target organs for effects due to optical radiation, and action spectra also exist for effects on skin and eye (ICNIRP, 2013). The type of effect, injury thresholds and damage mechanisms vary significantly with wavelength. There are several variables to be taken into account when referring to effects of optical radiation from LEDs on human health: spectrum of an LED light source; intensity of the lighting, especially in the blue/violet part of the spectrum; duration of exposure; exposure level of the eye or skin; health of the eye or skin; direct staring without deviation versus active eye movement.

The specific safety requirements and risk assessment methods regarding photobiological hazards are contained within several European safety standards. In order to assess the potential health risks associated with LEDs, it is necessary to take into account all exposure parameters - the *irradiance* (the flux of optical radiation that reaches a target, distance dependent), the *radiance* (radiation flux leaving the source depending on emission angle, independent of distance to target), LED spectrum, and the exposure duration.

People are exposed to optical radiation from a range of sources including different LEDs in any given 24-hour period. For many people, exposure to natural optical radiation will predominate, i.e. exposure to optical radiation from LEDs is likely to be insignificant compared with the exposure to natural light outdoors.

### **Potential health effects of LEDs in the general population**

Published studies show that the blue light-weighted (for eyes) radiance from screens (for example computer/tablet/mobile phone/TV) is less than 10% of the ICNIRP blue light photochemical retinal exposure limit, assuming viewing greater than about 3 hours (acute exposure). See Annex IV on dosimetry.

The search of the literature for the long-term impact of LED emissions on human health did not identify any studies since the technology has been recently distributed on the market for the general population. Because the technology is still evolving, it is important to continue monitoring the scientific literature.

The SCHEER concludes that the available scientific research does not provide evidence for health risks to the eye or skin associated with LEDs when the total exposure is below the international agreed exposure limits (ICNIRP).

It is expected that the risk of adverse effects will increase if these limits are exceeded. However, there is insufficient information in the scientific literature on the dose-response relationship for adverse health effects for optical radiation exposure of the healthy general public.

In addition, no evidence was found for increased risk of skin photosensitivity from LED lamps when compared with other lighting technologies. Indeed, the absence of ultraviolet radiation from general LED lamps may reduce the risk of skin photosensitivity for a number of these conditions.

Although not completely understood, experiments have shown that, overall, circadian rhythms are mostly affected by short-wavelength light (peak around 480 nm). It has been shown that normal use of LEDs or screens illuminated by LEDs during the evening can perturb the circadian system, as do other types of artificial lights. Light sources with a higher component of short-wavelength light, such as some LEDs, have increased impact on the circadian system, perhaps influencing sleep quality. At the moment, it is not yet clear if this disturbance of the circadian system leads to adverse health effects.

Although there is some evidence that use of screens technology into the evening may impact sleep quality, it is not clear whether this is due to the optical radiation or the activity being carried out.

In addition, some LEDs raise concerns in terms of temporal light modulation (flicker). Observers of some point-like LED sources may experience dazzle, distraction and glare. This was also reported to be a concern with some LED street lights.

Temporal light modulation from some LED lamps can cause stroboscopic effects. There are claims by a small number of people of adverse health effects such as migraines or headaches. There appear to be no technical reasons why LED lamps need to produce a time-modulated emission, since many models do not.

### **Potential health effects of particular LED sources (toys, car lights)**

The European standard EN 62115 for electronic toys limits the emission of optical radiation from toys. This is because some LED emission spectra may induce photochemical retinopathy, which is a concern, especially for young children.

LEDs are used in virtual reality headsets where the screen is very close to eyes. However, the luminance of the source is very low and the exposure limits are not likely to be exceeded. The reported disorientation and nausea after extended use of these headsets is likely to be due to effects such as motion sickness rather than the optical radiation emitted by the screen.

The SCHEER is concerned about the high-luminance exterior sources used on some vehicles. Current examples appear to be blue-rich, which increases glare and scattering, particularly for older observers. The internal car lighting with LEDs that has replaced standard incandescent bulbs has emission levels that will result in exposures significantly below internationally agreed exposure limits. However, some exhibit pulsed emission modes that can result in phantom arrays when the head or eye is moved quickly. Such effects can be distracting. Distraction, dazzle and glare effects do not result in direct harm to the eye, but there could be consequences if the person exposed is carrying out a safety-critical task, such as driving.

### **Susceptible groups**

People who suffer from photosensitive conditions have been considered.

As the eye ages scattering may increase. This is a particular problem for blue light. Therefore, older people may experience discomfort problems with exposure to LED systems with a high blue content, not clearly seeing the blue LED displays (such as destination displays on the front of buses).

People with degenerative and vascular disease of the retina may be more susceptible to harm from LEDs than the general population, but the risk is considered similar to that from other lighting sources with similar emission characteristics.

Although emissions from toys are regulated and deemed safe, blue LEDs may be very dazzling for young children.

### **Additional aspects to consider**

The worst-case viewing condition is generally on axis viewing of an LED source, for example staring at a screen or an LED lamp. If a source is safe for viewing on axis it will be safe under all other viewing conditions at the same distance.

Flashing LED sources in the peripheral vision are more likely to cause distraction than those on axis.

LED lamps used for area illumination are usually more energy efficient than many other sources. For the same colour temperature, the blue light component of the optical emission can be similar to that of an incandescent lamp. However, the infrared (and



possible ultraviolet emission) may be greatly reduced or absent (in comparison with other types of lamps), which might influence (positively or negatively) the normal human physiology. This aspect needs further research.

## 2. MANDATE FROM THE EU COMMISSION SERVICES

### 2.1 Background

The Light-Emitting Diode (LED) is a semiconductor light source that releases energy in the form of light when a suitable voltage is applied to it. LEDs are used in home lighting, laptop and phone screens, TV sets, traffic signals and are increasingly becoming used as a light source in the automotive industry, to mention a few applications.

The LEDs are energy efficient and last much longer than the conventional light sources, which make them widely used by the general population. Hence it is important to know the implications of LED radiation on the human health.

Recently, researchers have analysed potential risks of white LEDs [1], issuing recommendations to avoid the hazards. Another group of researcher has speculated about the effects of LED radiation on retinal epithelium cells (RPE) [2],

The human visual system is exposed to high levels of natural and artificial lights of different spectra and intensities along lifetime. These lights give rise to the formation of reactive oxygen species and induce mutagenic mechanisms which lead to apoptosis and consequently to degenerative eye diseases, such as age-related macular degeneration (AMD).

There are several variables to be taken into account when referring to LEDs effects on human health: 1) spectrum of an LED light source, 2) intensity of the lighting, especially in the blue band, 3) duration of exposure, 4) health of the eye, 5) direct staring without deviation versus active eye movement.

According to the SCENIHR Opinion on artificial light<sup>1</sup>: "blue radiation directly from bright cold white light sources in proximity of the workers eyes (e.g. task lights) or strong projectors (floodlights, accentuation and scenic lighting, etc.), or reflected may represent a risk for retinal damage; the blue light component from cold white reading lights may perturb circadian rhythm of the user; a child's crystalline lens is more transparent to short wavelengths than that of an adult, making children more sensitive to blue light effects on the retina."

### Legal background

At international level, recommendations for exposure limit values (ELVs) to protect against adverse effects of optical radiation are established by the International Commission on Non-Ionizing Radiation Protection (ICNIRP) and apply both to the occupational population and the general public.

At EU level, the following legal framework exists that aims at minimising the risks posed by the LEDs.

Regarding the protection of the occupational population, the ELVs of Directive 2006/25/EC<sup>2</sup>, which set the minimum safety requirements regarding the exposure of

---

<sup>1</sup>[http://ec.europa.eu/health/scientific\\_committees/emerging/docs/scenih\\_r\\_o\\_035.pdf](http://ec.europa.eu/health/scientific_committees/emerging/docs/scenih_r_o_035.pdf)

<sup>2</sup>Directive 2006/25/EC of the European Parliament and of the Council of 5 April 2006 on the minimum health and safety requirements regarding the exposure of workers to risks arising from physical agents (artificial optical radiation) (19th individual Directive within the meaning of Article 16(1) of Directive 89/391/EEC), JO L 114 of 27.04.2006

workers to risks arising from artificial optical radiation, are based on the ICNIRP recommendations applicable at the time of publication<sup>3</sup>.

Furthermore, the safety of LEDs (unless they are less than 50 V AC or 75 V DC) falls under the scope of the Low Voltage Directive (LVD) 2014/35/EU<sup>4</sup>. LEDs must comply with the safety objectives of Annex I of the Directive that include all type of risks, guaranteeing a high level of protection of health and safety of persons.

If LEDs are less than 50 V AC or 75 V DC, their safety is covered by the General Product Safety Directive 2001/95/EC<sup>5</sup>.

All European standards (EN) related to LVD are voluntary, but if harmonised and published in the Official Journal of the European Union, they would provide presumption of conformity with the safety objectives of the LVD.

EN 62471 on the "Photobiological safety of lamps and lamp systems" sets a risk group structure and methods to assess the photo-biological risks of lamps including LEDs.

The specific safety requirements regarding photobiological hazards are contained within the LED modules and luminaire safety standards (EN 62031 and EN 60598-series) and in other lamp safety standards: EN 62560 and EN 62776.

## 2.2 Terms of Reference (ToR)

The Scientific Committee is asked to assess the safety risks associated with the use of LEDs and to provide an answer to the following questions:

1. What are the potential health hazards associated with LEDs emission in the general population with regard to wavelength, intensity, duration and viewing position?
2. If possible, identify dose response relationship associated with LEDs emission in the general population with regard to wavelength, intensity, duration and viewing position?
3. What are the potential health risks associated with LED displays (e.g., TV sets, laptops, phones, toys and car lighting) in the general population and in vulnerable and susceptible populations (e.g., children and elderly people)?
4. What are the potential health risks associated with LED lamps (e.g., toys and car lighting) in the general population and in vulnerable and susceptible populations (e.g., children and elderly people)?

---

<sup>3</sup> International Commission on Non-Ionizing Radiation Protection (ICNIRP): "Guidelines on limits of exposure to broad-band incoherent optical radiation (0.38 to 3 µm)", Health Physics 73 (3), 539-554 (1997)  
<http://www.icnirp.org/cms/upload/publications/ICNIRPbroadband.pdf>

International Commission on Non-Ionizing Radiation Protection (ICNIRP): "Guidelines on limits of exposure to ultraviolet radiation of wavelengths between 180 nm and 400 nm (incoherent optical radiation)", Health Physics 87 (2), 171-186 (2004)  
<http://www.icnirp.org/cms/upload/publications/ICNIRPUV2004.pdf>

<sup>4</sup> Directive 2014/35/EU of the European Parliament and of the Council of 26 February 2014 on the harmonisation of the laws of the Member States relating to the making available on the market of electrical equipment designed for use within certain voltage limits, OJ L 96, 29.3.2014, p. 357-374

<sup>5</sup> Directive 2001/95/EC of the European Parliament and of the Council of 3 December 2001 on general product safety, OJ L 11, 15.1.2002, p. 4-17

### 3. OPINION

The SCHEER replies to the questions in the terms of reference.

*Q1. What are the potential health hazards associated with LEDs emission in the general population with regard to wavelength, intensity, duration and viewing position?*

LEDs are optical radiation emitters. Optical radiation does not penetrate deeply into the body; the eye and skin are the organs that are most susceptible to damage.

The risks following exposure to optical radiation hazards are a complex function of wavelength and exposure conditions. International organisations, such as the International Commission on Non-Ionizing Radiation Protection (ICNIRP), have produced weighting functions for different hazards associated with optical radiation. ICNIRP guidelines for optical radiation in general do not differentiate between exposure to workers and exposure to the general public.

The type of effect, injury thresholds and damage mechanisms vary significantly with wavelength. More than one effect can occur within overlapping wavelength ranges. Therefore, these effects have to be evaluated independently. Action spectra for selected wavelength ranges, intensity and exposure duration exist for specific biochemical reactions in the skin and eye.

The SCHEER takes these action spectra for the following parameters: wavelength, intensity, duration and viewing position to assess the potential hazard.

#### *Wavelength*

Most current white-light LED lighting devices (blue LED and yellow phosphor) emit blue light combined with green/yellow light without significant red or any near infrared wavelengths. Whether or not the absence of ultraviolet or near infrared wavelengths has any health implications is now under investigation.

Published studies show that the blue light-weighted (for eyes) radiance from screens is less than 10% of the blue light photochemical retinal hazard limit, assuming viewing greater than about 3 hours (acute exposure). See Annex IV on dosimetry. For a comparison, 14% of that limit corresponds to a mid-range incandescent lamp. The ICNIRP guidelines are based on observed eye or skin injury after experimental exposure of primates and rodents, and on information from human accidents. Reduction factors are used in setting the exposure limits for humans when animal studies are used.

It has been shown that normal use of LEDs or screens illuminated by LEDs during the evening can perturb the circadian system influencing sleep quality because of the high component of the short-wavelength light. However, the full action spectrum for the influence of light on the circadian system requires further research as other wavelengths have an influence as well. At the moment, it is not clear if this evening disturbance of the circadian system leads to long-term adverse health effects.

#### *Intensity*

Radiant intensity (W/sr) is a parameter characterising the emission of the source, while luminous intensity (lm/sr) is important in terms of visual perception including distraction, glare and after-images.

The optical radiation incident on a target tissue is expressed in terms of irradiance ( $\text{W}/\text{m}^2$ ) or illuminance ( $\text{lm}/\text{m}^2$  or lux).

For photochemical processes, the effect is a function of not only the irradiance (or radiance) but also of the exposure duration. The product of these two factors gives the dose (the radiant exposure ( $\text{J}/\text{m}^2$ ) or radiance dose ( $\text{J}/\text{m}^2\text{sr}$ )). The irradiance (or

radiance) used in this calculation of effects is weighted by the appropriate action spectrum. Most people receive exposure to optical radiation from a range of sources including different LEDs in any given 24-hour period. In order to assess the potential health hazards associated with LEDs, it is necessary to take into account all of these exposures. For many people, exposure to natural optical radiation will predominate, i.e. exposure to optical radiation from LEDs is likely to be insignificant compared with the exposure to natural light outdoors. The SCHEER concludes that the available scientific research does not provide evidence for health hazards associated with LEDs when the total exposure is below the ICNIRP exposure limits. However, reversible biological effects in terms of flicker, dazzle, distraction and glare may occur.

Animal experiments and *in vitro* studies suggest that cumulative blue light exposure below the levels causing acute effects can also induce photochemical retinal damage. The search of the literature for long-term impact of LED emission on human health did not identify studies investigating the healthy general population. However, technology is still evolving and it is important to continue to monitor the literature.

Due to the point-source nature of some LED lighting, studies have shown that these emitters can cause discomfort and glare.

#### *Duration*

The time spent in school, work and/or leisure activities with the use of LED screens should not exceed the recommended exposure limits of ICNIRP. In addition, the cumulative effect of light on the skin and eyes should be considered.

#### *Viewing position*

The worst-case viewing condition is generally on axis viewing of an LED source, for example staring at a screen or an LED lamp. If a source is safe for viewing on axis it will be safe in all other viewing conditions at the same distance. However, flashing LED sources in the peripheral vision are more likely to cause distraction than those on axis.

#### *Q2. If possible, identify dose response relationship associated with LEDs emission in the general population with regard to wavelength, intensity, duration and viewing position*

If the exposure is below ICNIRP exposure limits, the SCHEER is not aware of any risk of damage to the eye and skin. The risk of damage to the eye or skin will increase if ICNIRP exposure limits are exceeded. Although a general threshold has been identified for optical radiation based on experimental data, the profile of the dose-response relationship is not well known.

Since LED emission characteristics like exposure patterns and spectra (wavelength-dependent intensity) vary from one emitter to another, it is not possible to predict the profile of the dose-response function for a general LED emitter.

*Q3. What are the potential health risks associated with LED displays (e.g., TV sets, laptops, phones, toys and car lighting) in the general population and in vulnerable and susceptible populations (e.g., children and elderly people)?*

Evaluating the retinal blue light hazard effectively requires taking account of the irradiance of the retinal image of the source viewed. For momentary viewing, the retinal image subtends the same angle as does the source. With increasing exposure time, the retinal image is spread over an increasingly large area of the retina due to eye movement (saccades) and task-determined movement, resulting in a corresponding reduction in retinal radiant exposure at any given point on the retina. A time-dependent function of the angular subtense of the retinal image for exposures from 0.25 sec (aversion response time) to 10,000 sec is defined, ranging from 1.7 mrad (taken as the smallest image formed on the retina) to 100 mrad.

Published studies show that the blue light weighted radiance from screens is less than 10% of the blue light hazard limit that is defined to protect the retina regarding photochemically induced injury.

Light from screens has been shown to influence the circadian system. There is some evidence that use of screen technology into the evening may impact sleep quality. However, it is not clear whether this is due to the optical radiation or the activity being carried out.

There is a European standard for electronic toys that limits the emission of optical radiation from toys. However, children have a higher sensitivity to blue light and although emissions may not be harmful, blue LEDs may be very dazzling for young children. Some LED emission spectra may induce photochemical retinopathy, which is especially a concern for children below about three years of age. The standard does not take into account a product that is not a toy, which may be given to a child to use (for example smartphones or tablets).

Internal car lighting with LEDs has replaced standard incandescent bulbs in new vehicles. Emission levels are significantly below ICNIRP exposure limits for blue light to eyes. Since many such LED sources are operated in pulsed emission modes this can result in phantom arrays when the head or eye is moved quickly. Such effects can be distracting.

As the eye ages, scattering may increase. This is a particular problem for blue light. Therefore, older people may experience discomfort with exposure to LED systems, including blue LED displays (for example destination displays on the front of buses will be blurred).

People with degenerative and vascular disease of the retina may be more susceptible to harm from LEDs than the general population, but the risk is considered similar to that from other lighting sources with similar spectral characteristics and under similar human exposure conditions.

LEDs are used in virtual reality headsets where the screen is very close to eyes. However, the luminance of the source is very low and the exposure limits are not likely to be exceeded. Manufacturers give guidance on maximum duration of use for such headsets. Some people report disorientation and nausea after extended use of these headsets. This is likely to be due to the motion sickness rather than the optical radiation emitted by the screen.

*Q4. What are the potential health risks associated with LED lamps (e.g., toys and car lighting) in the general population and in vulnerable and susceptible populations (e.g., children and elderly people)?*

LED lamps used for area illumination are usually more energy efficient than other sources and therefore consumers have been encouraged to use them instead of, for example, incandescent lamps. Most domestic applications are likely to use retrofit lamps. For the same colour temperature, the blue light component of the optical emission is similar to an incandescent lamp. However, the infrared (and possible ultraviolet emission) may be greatly reduced or absent (in comparison with other types of lamps), which might influence (positively or negatively) the normal human physiology.

It is good practice in lighting design to ensure that lamps for illumination are either positioned outside of the usual field of view or are of such low luminance that the source does not produce significant glare. Some sources available on the market incorporate "point" LED sources without diffusers, which can cause glare if viewed. This was also reported to be a concern with some LED street lights.

Temporal light modulation (TLM) has been measured at 100 Hz from some LED lamps. It is not possible for consumers to identify which LED lamps exhibit TLM and which do not at the point of purchase. Since some LED lamps have TLM of almost 100%, this can result in stroboscopic effects (for example a waved hand appears as a series of stationary images). A small number of people report adverse health effects such as migraine or headaches. Although not a direct adverse health effect, it is foreseeable that any moving machinery (including food mixers) may appear stationary at particular speeds under flickering LED lamps. There appear to be no technical reasons why LED lamps need to produce time-modulate emissions, since many models do not. However, the use of a dimmer switch may introduce temporal modulations in LED lamps that do not flicker on full power.

The SCHEER is concerned about the high luminance sources used on some vehicles, particularly daylight running LED lights that remain on without dimming at night. Current examples appear to be blue-rich, which increases glare and scattering, particularly for older observers. These running lights are a greater glare source in fog than more traditional vehicle lighting. However, the SCHEER is not aware of any risk of direct harm to the eyes from the blue light component of external vehicle LED lighting at normal viewing distances, although if a driver's vision is impaired this could result in accidents.

Apart from the concern over TLM, no evidence was found for increased photosensitivity risk from LED lamps when compared with other lighting technologies. Indeed, the absence of ultraviolet radiation from general LED lamps may reduce the risk of photosensitivity for a number of these conditions.

There is a European standard for electronic toys that limits the emission of optical radiation from toys. However, children have a higher sensitivity to blue light and although emissions may not be directly harmful, blue LEDs may be very dazzling for young children.

#### *Additional information*

Many LEDs contain toxic substances and in order to assess their potential health impact/effect there is a need for further research on waste management.

#### **4. MINORITY OPINIONS**

No minority Opinion.



## 5. DATA AND METHODOLOGY

The general approach by the Scientific Committee to health risk assessment is to evaluate all available evidence from human, animal and mechanistic studies regarding effects to exposure to the agent of concern and then to weigh this evidence together across the relevant areas to generate a combined assessment.

Throughout the Opinion, consistency and adherence to the International System of Units (SI) regarding the use of terms and units has been used. For definitions and abbreviations please, refer to the Glossary of terms and to Abbreviations.

### 5.1 Data/Evidence

#### Data

The primary source of scientific data for this Opinion was papers and reports published in international peer-reviewed scientific journals in the English language available on PubMed, Scopus and Web of Science. Information has also been taken from technical reports from different agencies and bodies. The literature review carried out is outlined in Annex VII, including the search key words used.

The overall quality of the studies is taken into account in a tiered approach (Figure 1), as well as the relevance of the studies for the issue in question.

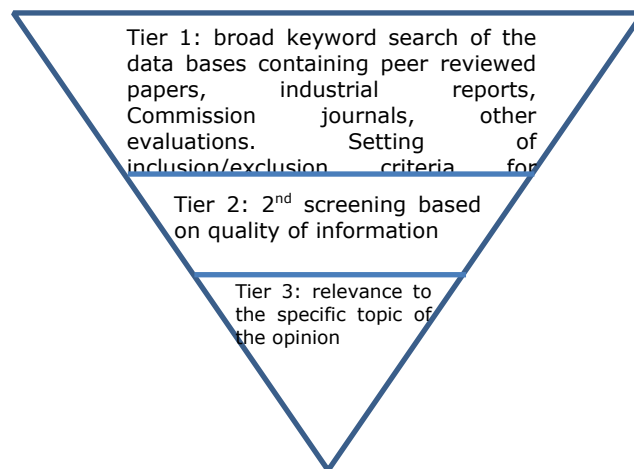

**Fig.1: Tiered approach in selection of publications based on their relevance and quality**

#### Evidence

The health risk assessment evaluates the evidence within each of the identified areas and then weighs the evidence together across the areas to generate a combined assessment. This combined assessment addresses the question of whether or not a hazard exists, i.e. if there is a causal relationship between exposure and some adverse health effect.

In the present Opinion, the potential risks to human health of LEDs have been assessed by reviewing the literature on epidemiological studies, experimental studies in humans, experimental studies in animals and mechanistic *in vitro* studies.

## 5.2 Methodology

The potential health risks to human health of LEDs have been studied via different approaches as controlled studies, case reports, and experimental studies in animals. Also keeping the benefits from the LED lighting in mind, the risk from the LED optical radiation hazard may be managed by exposure optimisation. This is shown in Figure 2, below.

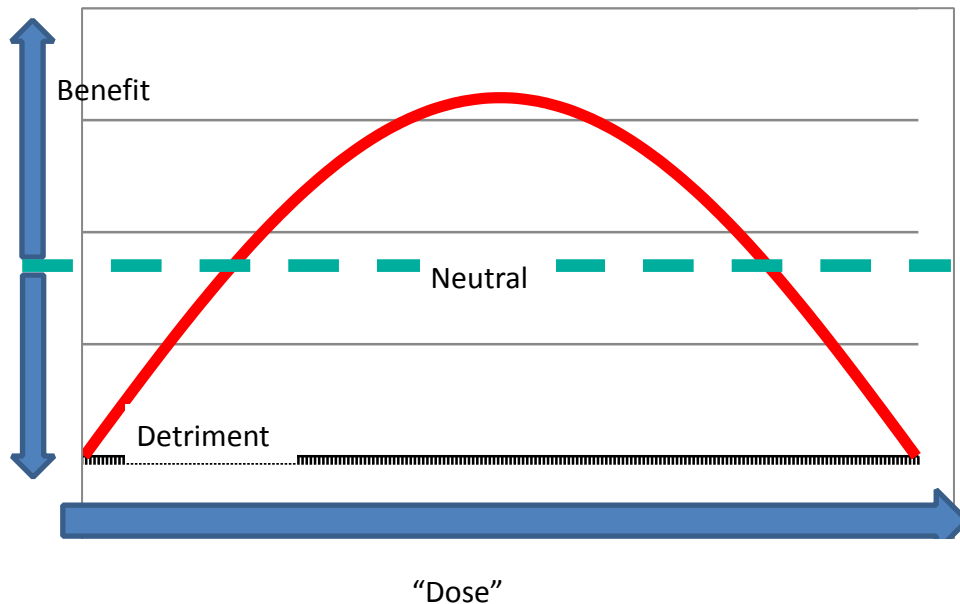

**Fig. 2: Plot of general benefit vs detriment showing that detriment may increase as dose of optical radiation reaches low levels.**

The shape of the curve in Figure 2 depends on a number of factors, such as the part of the optical spectrum under consideration, time of exposure, prior exposure, possibly age and individual differences (such as photosensitivity, eye pathologies, etc.). For example, too little ultraviolet radiation exposure may result in vitamin D deficiency and associated health effects. High levels of ultraviolet radiation may result in sunburn and an increased risk of skin cancer. Therefore, an exposure between the two is optimum. For light, if the task is reading, there is an optimum illuminance of the page: too little and we cannot see, too much and we are dazzled or in extreme cases risk eye injury. Therefore, reducing the exposure level to as low as achievable may have adverse consequences, some of which will be health related.

The risk assessment approach used in this Opinion is based on that promoted by the European Commission for workplaces (EC 1996) and for products used by consumers (EC 2015).

This Opinion is primarily concerned with the risk arising following exposure of the eyes or skin to optical radiation from LEDs. Therefore, this will be considered the hazard. It may be necessary to quantify the hazard using an appropriate metric, but usually quantification is only relevant if the optical radiation exposure geometry and distance substantiate the risk of exposure of people. If exposure is possible then the exposure scenario needs to be considered. For example, if the source of exposure is an indicator LED, or if it forms part of a display screen, then it is very likely that people will view the source. However, for many illumination sources, the LED should be shielded from direct

viewing and such direct viewing will be likely only under accidental or improper use conditions. Once an exposure scenario has been identified, the optical radiation exposure conditions, for example of the eye or skin, will need to be quantified and compared with relevant limits. These limits may be instantaneous limits or time-averaged limits. In the latter case, exposure from a number of different sources throughout a day will need to be considered. If the exposure is less than the relevant limit, then the risk of adverse health effects is considered low. This assessment needs to be carried out under normal use of the LED and under reasonably foreseeable conditions of misuse.

In addition to consideration of direct harm, the risk assessment also needed to consider issues that may arise from direct viewing of some LED sources where the risk arises due to temporary visual impairment, such as distraction, glare and after-images. These effects depend not only on the optical radiation incident on the eye, but also the ambient light level and the task being carried out at the time of exposure.

A third category of risk is potentially due to the temporal characteristics of the optical radiation emitted by the LED. The potential effects may be due to the actual emission of the source as directly viewed, or due to head or eye movement, or to the impact on moving equipment.

A fourth category is where exposure to optical radiation from an LED may impact the circadian rhythm or other aspects of wellbeing.

These issues are addressed in this Opinion.

## 6. ASSESSMENT

### 6.1. Photometry and radiometry

LED characteristics including physical size, flux levels, spectrum and spatial distribution, separate them from typical element sources, which are generally employed and measured for photometric and radiometric quantities. For every radiometric quantity there is a photometric analogue.

Photometry is the science of the measurement of light, in terms of its perceived brightness to the human eye. It is distinct from radiometry, which is the science of measurement of radiant energy (including light) in terms of absolute power. Concepts such as radiance, irradiance, radiant power and radiant intensity used in radiometry can easily be defined via simple geometric relationships. While sharing these identical relationships, photometry also introduces detector response modelled after human visual characteristics.

Radiometry deals with the measurement of electromagnetic radiation across the total spectrum (infrared, visible, ultraviolet and beyond). Photometry is concerned only with the visible portion of the spectrum, from about 380 nm to 780 nm and measures luminous flux, luminous intensity, illuminance and luminance.

All radiometric and photometric quantities are defined in detail in the glossary.

Table 1 indicates the symbols and the units of the quantities; the indices "e" = "energetic"; "v" = "visual".

**Table 1: Radiometric and photometric quantities**

Radiometric			Photometric		
Quantity	Symbol	Units	Quantity	Symbol	Units
Radiant Power	$\Phi_e$	W	Luminous Flux	$\Phi_v$	lumen (lm)
Radiant Intensity	$I_e$	W/sr	Luminous Intensity	$I_v$	lm/sr
Irradiance	$E_e$	W/m <sup>2</sup>	Illuminance	$E_v$	lm/m <sup>2</sup> or lux
Radiance	$L_e$	W/m <sup>2</sup> sr	Luminance	$L_v$	lm/m <sup>2</sup> sr

The luminosity function or luminous efficiency function describes the average spectral sensitivity of human visual perception of brightness. It is based on subjective judgements of which of a pair of different-coloured lights is brighter, to describe relative sensitivity to light of different wavelengths. As defined by the Commission Internationale de l'Éclairage (CIE) the luminosity function  $V(\lambda)$  is a standard function, which may be used to convert radiant energy into luminous (i.e., visible) energy (see Annex IV Photometry and Radiometry for details).

## 6.2 Physical characteristics of LEDs sources

The basic technology of an LED is that of a conventional diode, i.e., the creation of a positive-negative or p-n junction by doping (impregnating) semiconductor materials with impurities. In a p-n junction, current can flow from the p-side of the material to the n-side, but not in reverse. As electrons move and meet holes, they fall into a lower energy level by the emission of photons. The wavelength (colour) of the light thus emitted depends on the band gap energy of the semiconductors that form the p-n junction. It should be noted, however, that there are situations (e.g., silicon or germanium diodes) where the recombination of electrons and holes does not lead to an optical emission.

The spectral irradiance for a domestic retrofit LED lamp is shown in the Figure 3, with the spectrum from an incandescent lamp for comparison. However, the emission spectrum depends on the type of LED. In particular, for white light LED lamps, the emission may be produced by a blue LED accompanied by a broad emission phosphor (as shown in the Figure 3) or by multiple LEDs emitting different colours that can be mixed in various proportions to produce "white" at different colour temperatures.

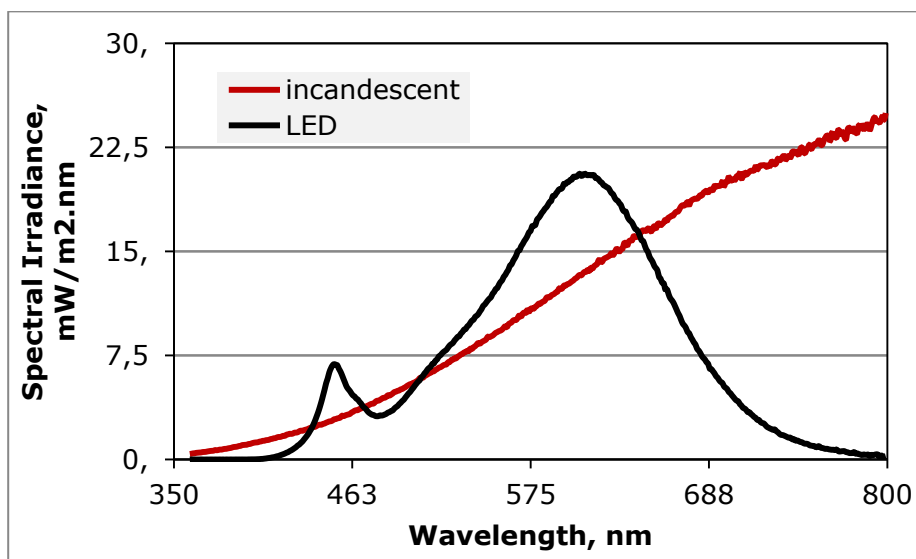

**Fig. 3: Emission spectra for a 60 W incandescent lamp and an equivalent lumen LED lamp (from O'Hagan *et al*, 2016)**

It is important to put exposure to optical radiation from LEDs into context with natural optical radiation sources. The data above is shown in Figure 4 on a log/linear scale for the spectral irradiance for comparison with a blue sky (minus any direct contribution from the sun). It can be seen that the spectral irradiance from the sky is about two orders of magnitude greater than from the LED or incandescent lamp over a considerable part of the spectrum shown.

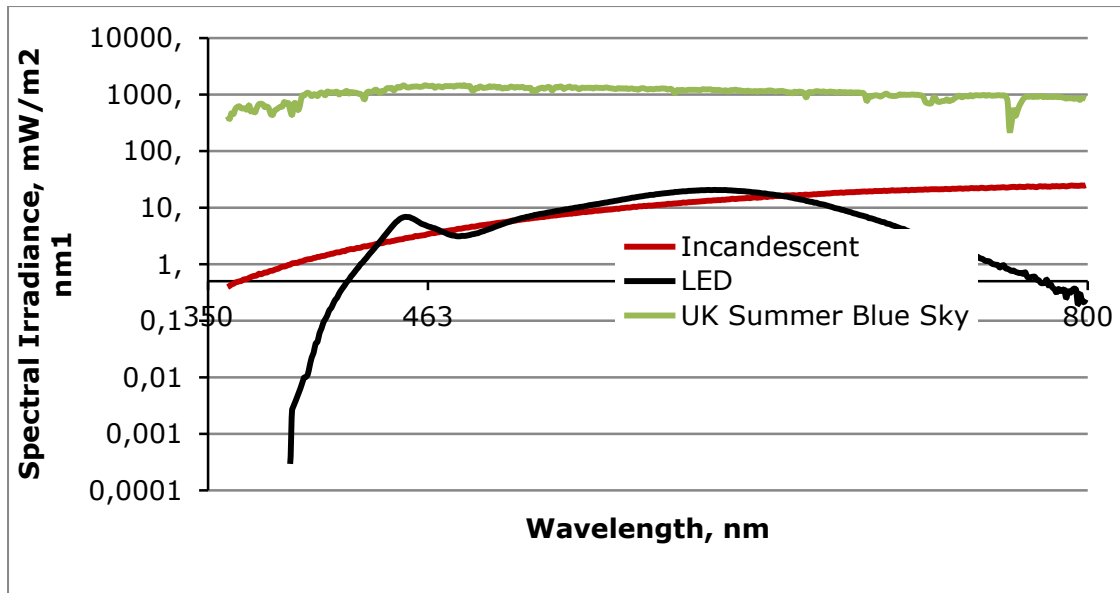

**Fig. 4: Comparison of the spectral irradiance from a blue sky with the LED and incandescent lamp shown in the Figure 3.**

Infrared LEDs (IRLEDs) have been used for many years in, for example, remote control systems. Although LED technology is still developing, ultraviolet (UV) LEDs have not yet replaced traditional sources of UV radiation in many applications.

Further information on LED technology is contained in Annex I.

### 6.3 Point source vs diffuse source

In this report it is necessary to differentiate not only between point source light (light emitted from an LED chip) and diffused light LED sources, but also between diffused light that illuminates the environment and diffused light emitted by (for example) an LED screen that is directly viewed by users. In this sense, the exposure conditions (irradiance, distance from source and exposure duration) are totally variable and should be considered independently. For example, screens are mostly tactile and the distances of use are dependent on the user's length of the arms and the quality of their eyesight. However, at any given time, a person is likely to be exposed to optical radiation from a range of different optical radiation sources, including optical radiation from the sun. Any exposure to optical radiation from LEDs needs to put into context.

To save energy, the European directives from the Eco-design of Energy Using Products (2005/32/CE) have recommended the replacement of incandescent lamps by more economic devices such as LEDs. However, the emission spectra from earlier types of white-light LEDs were rich in blue radiation, known to be potentially dangerous to the retina for high radiant exposures (Krigel *et al.*, 2016). Therefore, it is important to consider actual source characteristics and exposure conditions.

There are several variables to be taken into account when referring to effects of optical radiation from LEDs on human health: 1) spectrum of an LED light source, 2) intensity of the lighting, especially in the blue part of the spectrum, 3) duration of exposure, 4) exposure level of the eye or skin, 5) health of the eye or skin, 6) direct staring without deviation versus active eye movement.

#### 6.4. The interaction between light and matter

Light (or more generally optical radiation) reacts with matter in various ways. These interactions are based on the absorption of the optical radiation by matter. When the energy of a photon is taken up by matter, reflection (the optical radiation is returned either at the boundary between two media or at the interior of a medium), refraction (change in direction of wave propagation due to a change in its transmission medium), scattering (the process of deflecting a unidirectional beam into one or many directions), or absorption (Das, 1991; Elliott, 1995; Hillenkamp, 1989) may occur.

There are four basic mechanisms that can occur following absorption of optical radiation: photothermal, photochemical, photomechanical and photoelectric interactions (see Annex II for details). However, only the first two are relevant to the optical radiation from current LEDs.

#### 6.5. Eye optics fundamentals

A diagram of the human eye, showing the significant anatomical details, is shown below.

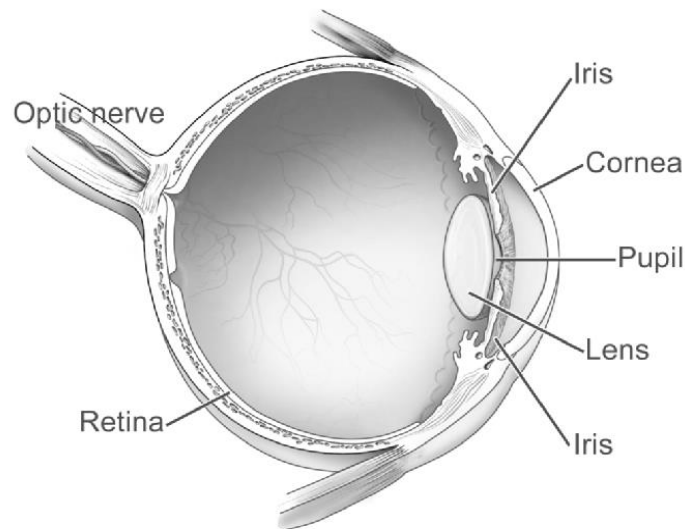

**Fig. 5: A diagram of the human eye (source: © National Eye Institute, National Institutes of Health)**

The visual sensitivity of the eye to optical radiation varies with wavelength between about 380 and 780 nm. The wavelength range varies between individuals and the absolute response also has a distribution. However, the International Commission on Illumination (CIE from the French, Commission Internationale de l'Eclairage) have published response curves for so-called standard observers, based on experimental studies, taking account of whether the light levels are high (day time), low (night time) or in between. These are termed photopic, scotopic and mesopic curves, respectively. The photopic and scotopic curves are shown in Figure 6.

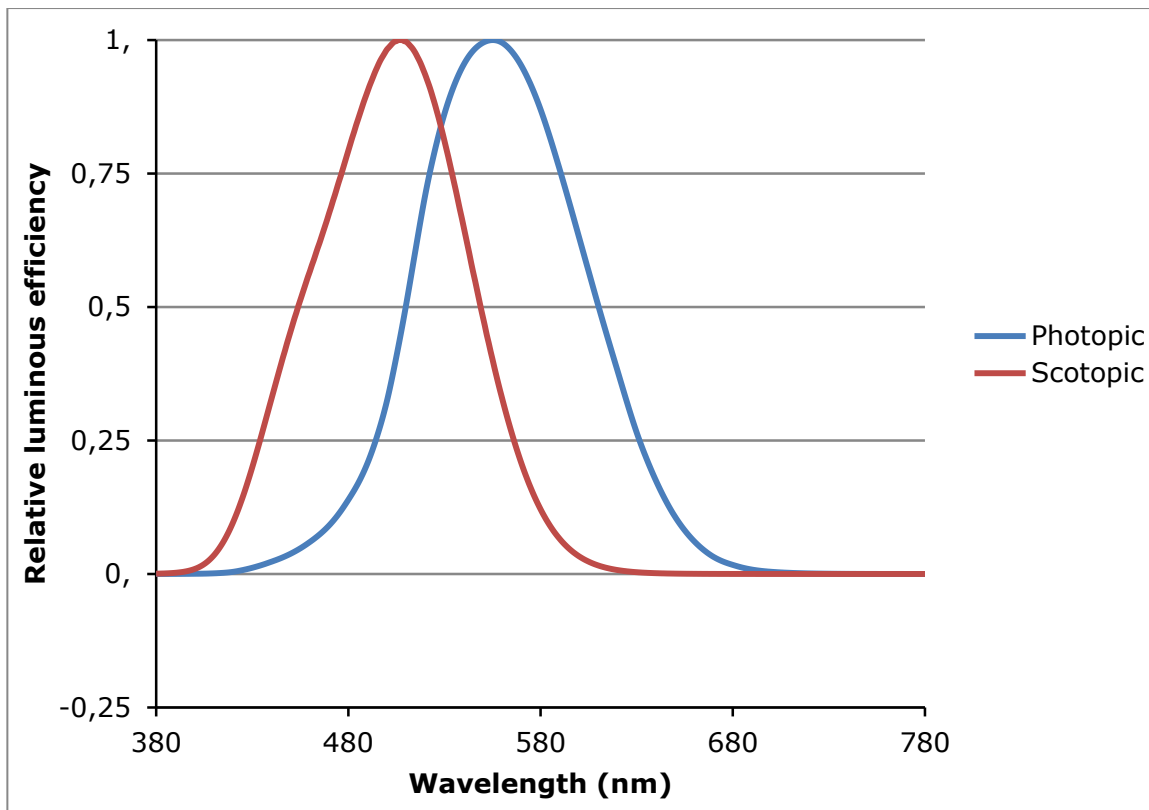

**Fig. 6: Relative luminous efficiency for photopic and scotopic vision**

### 6.5.1 Thermal and photochemical aspects

The risk of thermal effects is related to burns to the retina, generally resulting from short-term exposure to very intense visible and IR-A radiation. Lesions occur on the outer retina (photoreceptors and cells of the pigment epithelium) and appear after some time has passed (usually about 24 hours). With photochemical interactions, first, reactive oxygen species may be generated, second, the presence and action of these represent oxidative stress, and unless repair mechanisms and detoxification processes or adaptive processes alleviate the impact, cell death (any type) may occur (Serezhnikova *et al.*, 2017). Photoreactive pigments (lipofuscin) in the epithelium accumulate with age, increasing the risk of oxidative stress. The photopigment fragments thus created act as free radicals, which may lead to the death of the photoreceptor cells (Kuse *et al.*, 2014; Chamorro *et al.*, 2013). The radiation absorbed, which depends on the radiance of the light source and the duration of exposure, causes photochemical decomposition of the pigments present in the photoreceptor cells.

The retina is exposed to all of the visible wavelength range, the most severe retinal damage is likely to result from the effects of the shorter wavelengths (400-600 nm); this is commonly known as the "blue-light-hazard" (see action spectrum below, ICNIRP 2013). However, the retina contains a number of endogenous photosensitisers (such as vitamin A derivatives, lipofuscin, melanin, flavins, porphyrins and rhodopsin) which can be excited by visible/infrared radiation reaching the retina (Rożanowska *et al.*, 1995). In addition, exogenous photosensitisers, such as certain drugs, can induce ocular phototoxicity (Roberts, 2002). The retina contains many chromophores that can lead to photochemical damage when excited at each wavelength of light. Optical radiation emitted by LEDs may induce cell damage depending on the wavelength and therefore some wavelengths may produce more severe retinal photoreceptor cell damage than other wavelengths (Chamorro *et al.*, 2013). Short wavelength light can penetrate through tissues to the cells and their organelles, inducing the generation of reactive oxygen species (ROS) in RPE mitochondria and even apoptosis (Roehlecke *et al.*, 2009). Also, optical radiation emitted by LEDs can cause a phototoxic effect, especially from the



most energetic radiations: the violet and blue (400 – 500 nm) (Godley *et al.*, 2005). The higher toxicity of the blue part of the spectrum is recognised in the ICNIRP action spectrum for the blue light hazard shown in Figure 7. Also shown in Figure 7 is the aphakic action spectrum, intended for people without a lens, but which can also be applied for very young children.

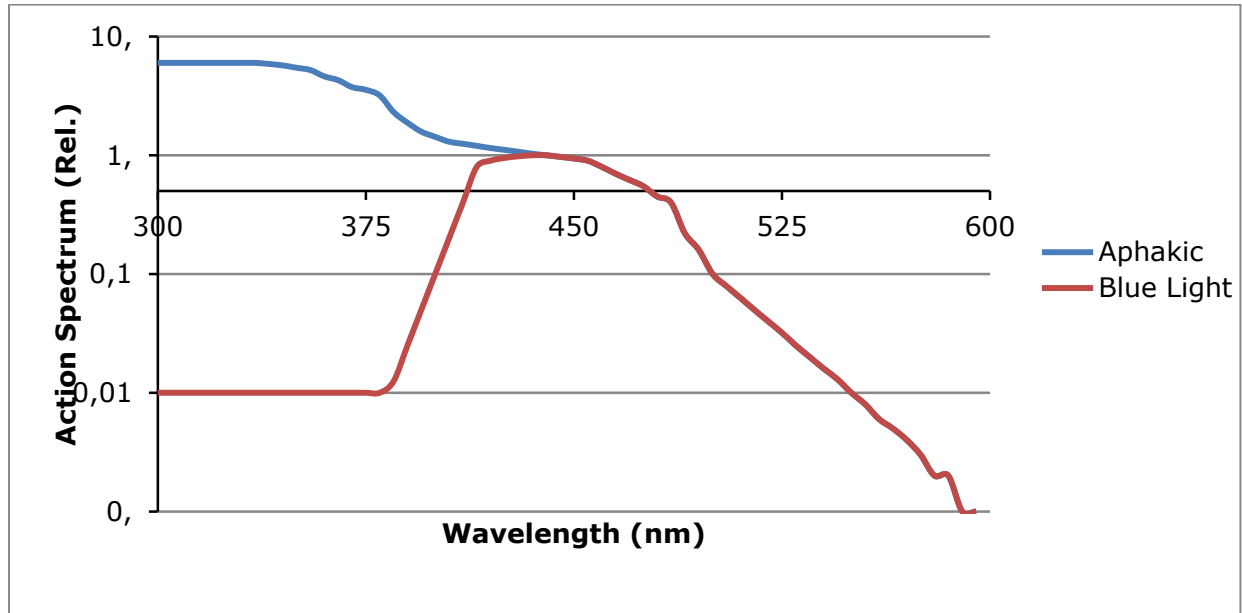

**Fig. 7: ICNIRP Blue Light and Aphakic Eye Action Spectra**

## 6.5.2. The effects on the healthy eyes

### 6.5.2.1. Computer Vision Syndrome

Computer vision syndrome (CVS) is the combination of eye and vision problems associated with the use of computers and was a concern before the introduction of LED screens. In modern society the use of computers for both vocational and recreational activities is almost universal. However, CVS may have a significant impact not only on visual comfort but also occupational productivity since between 64% and 90% of computer users experience visual symptoms which may include eyestrain, headaches, ocular discomfort, dry eye, diplopia and blurred vision either at near or far distance after prolonged computer use. Rosenfield (2011) reviewed the principal ocular causes for this condition, namely oculomotor anomalies and dry eye. Accommodation and vergence responses to electronic screens appear to be similar to those found when viewing printed materials, whereas the prevalence of dry eye symptoms is greater during computer operation. The latter is probably due to a decrease in blink rate and blink amplitude, as well as increased corneal exposure resulting from the monitor frequently being positioned in primary gaze.

The aim of another study (Argiles *et al.*, 2015) was to evaluate spontaneous eye blink rate (SEBR) and percentage of incomplete blinks in different hard-copy and visual display terminal (VDT) reading conditions, compared with baseline conditions. Its conclusions are that the high cognitive demands associated with a reading task led to a reduction in SEBR, irrespective of type of reading platform. However, only electronic reading resulted in an increase in the percentage of incomplete blinks, which may account for the symptoms experienced by VDT users.

### 6.5.2.2 Anterior Segment of the Eye

To date there is no evidence that commercially available LED light sources have a deleterious effect on the anterior segment (conjunctiva, cornea and lens) of the human eye.

It has been reported that the severity of damage induced by light depends on radiation intensity, radiation wavelength and time of exposure (Lee *et al.*, 2016). To date there are scientific reports showing that blue LED light at high doses (i.e. in excess of exposure limits) is toxic for the ocular surface. The excess of blue light LED radiation stimulates the production of pro-inflammatory cytokines (e.g., IL-1, IL-6, and IL-8, through the c-jun amino-terminal kinase [JNK] pathway, p38 pathway, and nuclear factor- $\kappa$ B [NF- $\kappa$ B] pathway) and enzymes (e.g. MMP-1) that mediate prostaglandin and leukotriene biosynthesis, as well as antioxidant enzymes in corneal epithelial cells (Lee *et al.*, 2016).

The overexposure to emitting violet radiation (410 nm) at 50 J/cm<sup>2</sup> can induce oxidative damage and apoptosis to the cornea, which may manifest as increased ocular surface inflammation and resultant dry eye compared to an LED emitting red and green irradiation (Lee *et al.*, 2016).

Regarding the lens, cataract is the major cause for legal blindness in the world (Ide *et al.*, 2015). Oxidative stress on the lens epithelial cells is the most important factor in cataract formation. Cumulative light-exposure from widely used LEDs may pose a potential oxidative threat to the lens epithelium. However, blue light exposure from the sky dominates and exposure to blue light from current LEDs is a small additional contribution to the natural exposure.

Xie *et al.*, (2014) analysed the photobiological effect of white LED light exposure with multichromatic correlated colour temperatures (CCTs) of 2954, 5624 and 7378K on human lens epithelial cells (hLECs). *In vitro* experiments showed that compared with 2954 and 5624 K LED light, LED light having a CCT of 7378 K caused overproduction of intracellular reactive oxygen species (ROS) and severe DNA damage, which triggered cell cycle arrest and apoptosis. These results indicate that white LEDs with a high CCT could cause significant photobiological damage to hLECs.

Caution should be exercised regarding the effect of LED light on the human lens as this study was conducted using human lens epithelial cells in cultures. Responses to blue light irradiation might be variable in clinical situations involving human subjects. Humans are not ordinarily exposed to blue light with high radiant exposure, as they were in experimental studies. It is possible that under specific occupational circumstances, humans may be exposed to high radiant exposure blue light. However, existing European legislation for the exposure of workers to artificial optical radiation would apply.

Some concern should be raised for medical professionals working under intensive shadowless lamps in the operating room. The incandescent or halogen light sources for surgical lamps are being replaced by more energy-efficient light emitting diodes (LEDs). However, occupational exposure legislation will apply.

### 6.5.2.3 Posterior Segment of the Eye

The present review did not identify any peer-reviewed literature demonstrating damage of the posterior segment of the human eye following exposure to optical radiation from commercially available white LED lamps in everyday life. Data are available only concerning the effect of LED light exposure or overexposure for *in vitro* or *in vivo* animal model studies.

Some concerns regarding possible hazard of LED light exposure comes from the fact that white light from LEDs appears normal to human vision, however a strong peak of blue light ranging from 460 to 500 nm may also be emitted within the white light spectrum;

this blue light corresponds to a potential retinal hazard, but only at levels significantly in excess of the exposure limits recommended by ICNIRP (Behar-Cohen *et al.*, 2011, Bullough *et al.*, 2017). See also Figure 3 for a comparison with the exposure to optical radiation from a blue sky.

The composition of the white-light spectrum differs among LED products and their light qualities may change over time. Although it is robust in the beginning, a white light LED may progressively release more short-wavelengths (blue light) when LED lumen depreciation occurs because of phosphor degradation. The quality of the light deteriorates after the lights pass below the 70% lumen maintenance level (U.S. Department of Energy 2009). These characteristics suggest that a white LED might cause more blue light exposure than other domestic lighting sources at the end of their life. Cumulative exposure to blue light has been argued to accelerate ageing of the retina and possibly play an etiological role in age-related macular degeneration (e.g. Behar-Cohen *et al.*, 2011).

Irradiating human RPE cells *in vitro* with three different LED light sources - blue (468 nm), green light (525 nm), red light (616 nm) or white light at an irradiance of 5 mW/cm<sup>2</sup> induce a significant reduction of the viability of the cells for all four LED sources (Chamorro *et al.*, 2013). However, ROS levels increased only after the exposure with blue, green or red light but not after the exposure to white light compared to non-irradiated cells, although there was an increased degradation of nucleic acids in all irradiated cells in comparison with control cells. Notwithstanding, apoptosis (cell death) also increases significantly following white light exposure (blue 86%, green 84%, red 66%, white 89%) compared to only 3,7% of apoptosis of the non-irradiated RPE cells. Summing up, three light-darkness cycles (12 h/12 h) exposure to LED lighting, including white LED, affect the growth of RPE cells and produce cellular stress, increasing ROS levels as well as increasing DNA damage and the number of apoptotic cells.

LED light at domestic lighting levels induced retinal injury in a Sprague-Dawley (albino) rat model after chronic exposure (Shang *et al.*, 2014; Shang *et al.*, 2017). Retinal cell function loss was demonstrated *in vivo* by electrofunctional test showing a significant decrease of bwave amplitude after 9 and 28 days of blue or white LED, or compact fluorescent lamp (CFL), light exposure. The findings were confirmed *ex vivo* by a significant thinning of the outer nuclear layer where the nuclei of photoreceptor cells are located and more apoptosis after blue and white LED light exposure, compared with the exposure to the light from the CFL. The retina has one of the highest oxygen consumption levels of tissues in the body and it is sensitive to oxidative stress (Yu and Cringle, 2005). Oxidative stress is the crucial risk factor for photoreceptor degeneration, which is caused by the generation of toxic ROS within retinal tissue. The retina contains enzymes involved in detoxification or synthesis, particularly in the outer segment or retinal pigment epithelium (Shang *et al.*, 2014; Shang *et al.*, 2017). The spectrum emitted by white LED lights contains photons with energies that exceed the threshold for damage of the enzymes serving as a stress-induced protection mechanism (Behar-Cohen *et al.*, 2011); thus, exposure to optical radiation from white LEDs may result in severe damage to the outer retina at high levels of exposure. Wavelengths at the higher energy end of the spectrum, as well as retinal irradiance, are risk factors that contribute to the risk of photochemical retinal injury. To prevent or decrease this potential retinal damage, some companies are increasing the market segments of lower colour temperature (i.e. lower blue component) LEDs for domestic lighting (U.S. Department of Energy 2012).

Recently the potential for retinal damage from optical radiation emitted by 10 commercially available LED light sources and an LED lantern for home use was evaluated (James *et al.*, 2017). Each lamp was tested by measuring the spectral irradiance and spectral radiance. The authors concluded that all light sources tested are in the exempt group according to the ANSI/IESNA Recommended Practice RP-27 series of documents (ANSI/IESNA 2005, 2007) which is the equivalent of the European Standard EN 62471 and therefore they do not pose an ocular hazard.

### 6.5.3 Potential effects on the non-healthy eyes

Age-related macular degeneration (AMD) is a multifactorial disease and a leading cause of blindness in the patients aged about 65 years or older in industrialised countries (Chu *et al.*, 2013; Wu *et al.*, 2014).

The typical pathology of advanced AMD is described as having two main forms: geographic atrophy (GA) and neovascular (exudative) AMD. Although pharmacologic treatment has changed the visual prognosis of exudative AMD, there is still a limited curative treatment for AMD, and therefore the best option is to prevent its onset by trying to point out possible risk factors which might contribute to further acceleration of the pathologic senescence process of the choroid, RPE and neuroepithelium. A growing number of studies indicate that the effect of oxidative stress contributes to AMD-related pathological changes (Beatty *et al.*, 2000; Lau *et al.*, 2011; Narimatsu *et al.*, 2013). Besides aging and smoking, the main source of oxidative stress can be cumulative light exposure, which may induce abnormal accumulation of reactive oxygen species in the macula.

A systematic review and meta-analysis revealed that individuals with high levels of sunlight exposure ("UVR exposure", "visible light exposure" and "blue light exposure" were all regarded as sunlight exposure) are at a significantly increased risk of AMD compared with? (Sui *et al.*, 2013). Furthermore, the risk for cataract extraction, as well as early AMD, is increased in subjects exposed to high levels of sunlight (Delcourt *et al.*, 2014). The cornea and natural crystalline lens absorb the most UVR and only a small fraction of UV-A (315 nm-400 nm) reaches the retina (Sloney, 2001). Although by 20 years of age only 0.1% UVR reaches the retina, due to the metabolites of tryptophan which absorb UVR (Sloney, 2002), blue light has a better ocular penetration than UVR, and by the age of 60–70 years old, there is still 40% of blue light (460 nm) reaching the retina (Behar-Cohen *et al.*, 2011).

The urban population tends to have longer duration of exposure to artificial lighting indoors rather than sunlight outdoors. However, for even a short period of time outdoors, the optical radiation exposure from sunlight tends to dominate (Fig. 4).

### 6.5.4. Vulnerable and susceptible populations

#### 6.5.4.1. Children

The transmission of UV-A and blue light to the retina is higher in young children than in older children (above about three years) and adults. The ICNIRP guidelines (ICNIRP, 2013) suggest that the action spectrum for aphakes may be appropriate for young children, generally considered to be those below about three years of age. This formed the basis of a recommendation on the emission limits for LEDs incorporated into toys (Higlett *et al.*, 2012).

#### 6.5.4.2. Adolescent

The studies of Kim *et al.* (2016) show that smartphone use has dramatically increased in recent years. According to the authors, smartphones may have adverse health effects, particularly on the eyes, because users stare at the screen for a much longer time than with previous generations of mobile phones. The objective of this study was to elucidate the relationship between smartphone use and ocular symptoms among adolescents (n=715). The conclusion was that the increasing use of smartphones can have a negative impact on ocular health in adolescents, although there was no implication that the optical radiation had any direct adverse health effect.

#### 6.5.4.3. Elderly population

No peer-reviewed studies were identified that suggested there was a specific risk to the older population from exposure to the optical radiation from LEDs. However, the ageing

eye transmits less blue light to the retina and is more susceptible to light scatter at these wavelengths.

There have been claims that blue-rich sources of light produce more glare for the older population. This is likely to be evident for LED displays (for example destination indicators on the front of buses) using blue light and for vehicle LED lighting.

## **Conclusion**

Although there are no reliable data to be used for risk assessment of eye-safety of life-time usage of LED light sources, there might be some concern on the potential negative consequences of LED emissions particularly in a susceptible population which already present early signs of pathologic senescence of the macula. However, it should be emphasised that those concerns derive from results obtained in experimental animal models or cell culture models using exposure levels greater than those likely to be achieved with LED lighting systems in practice.

Exposure to optical radiation from white LEDs may result in severe damage to the outer retina at high levels of retinal radiant exposure. Wavelengths in the blue range are a risk factor that contributes to the risk of photochemical retinal injury. To prevent or decrease this potential retinal damage, lower blue component LEDs for domestic lighting should be used.

## **6.6. Skin optics fundamentals**

### **6.6.1 Structure of the skin**

The layers of human skin, stratum corneum, epidermis and dermis (Figure 8) are composed of different cells as well as acellular structures, such as keratin and extracellular fluids (see Annex III for a short description of the various parts).

Fitzpatrick (1975) originally developed a scale of skin types for use in phototherapy treatment planning. The scale has been more widely adopted (Fitzpatrick 1988) to indicate the sensitivity of the skin to ultraviolet radiation (Annex III).

### **6.6.2 Optical properties of skin**

Optical properties of the skin are complex, and result from reflectance, absorption and scattering of the different wavelengths of incident optical radiation (for reviews see Anderson and Parrish, 1981, Lister *et al.*, 2012, Liu, 2012) (Figure 8).

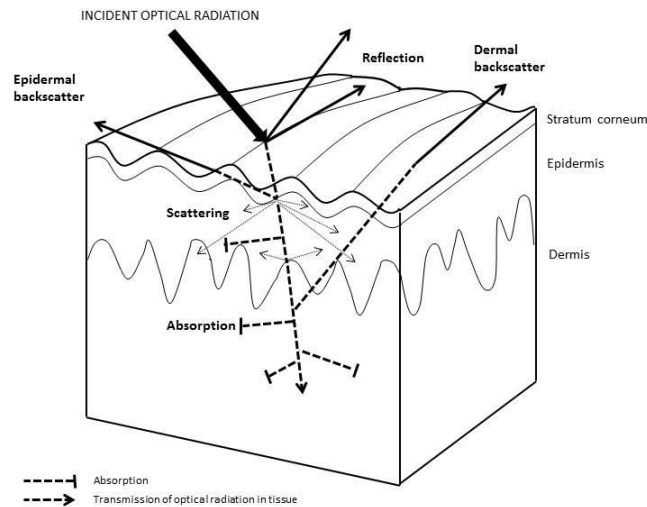

**Fig. 8: Optical pathways in the skin (source: E. Bruzell)**

When optical radiation reaches a tissue, some of the radiation is scattered back from the skin surface (reflection), some is absorbed in different layers, and some is transmitted into layers underneath until the incident energy is dissipated. The first optical interaction with skin occurs at the surface of stratum corneum. Due to the change in refractive index between air ( $n_D = 1.0$ ) and the epidermal surface ( $n_D = 1.55$  for the stratum corneum), a small fraction of incident optical radiation is reflected. *Reflectance* is the proportion of the incoming radiation that either penetrates the skin and is diffusively reflected back (epidermal and dermal backscatter; Figure 8) or that which is regularly (specularly) reflected from the skin surface (CIE, 2011). The regular reflectance from skin is always between 4% and 7% (angle dependent) in the wavelength range 250-3000 nm independent of skin type (Kohen et al, 1995). Transmission is the fraction of incident radiation that penetrates through the skin. Optical penetration depth is highly dependent on absorption (see 6.6.3).

*Absorption* is a process by which radiant energy is converted to a different form of energy by interaction with matter (CIE, 2011). Absorption of optical radiation in skin by biomolecules including water is wavelength-dependent. An atom or group of atoms that serve as a unit in light (optical radiation) absorption is called a chromophore. The organic molecules that absorb in the UV and visible range often have double bonds (Turro, 1991).

*Scattering* is a change in the direction, polarization or phase of light and results from either a surface effect (such as reflection or refraction) or from an interaction with molecules/particles with optical properties that differ from their surroundings (particle scatter). The major sources of particle scatter in the skin are the filamentous proteins: keratins within the epidermis, and collagens in the dermis. In addition, other structures/substances such as melanosomes in the epidermis contribute to light scattering in the skin. Scattering is influenced by the size of the filaments; it increases with increasing fibre diameter, and with wavelength (it increases with decreasing wavelength).

The overall optical properties of the skin depend on photon absorption and scattering by a wide range of biomolecules with specific chromophores. Typical UV absorbers in skin are DNA, melanin, 7-dehydrocholesterol (see Annex III) and several amino acids, such as tryptophan and tyrosine (Figure 9). Melanin, almost exclusively located in the epidermis in humans, is one of the major optical radiation absorbers. There are two

types of melanin: eumelanin which is black-brown and pheomelanin which is red-yellow. Their absorption spectra are wide, without specific peaks. Melanin absorption decreases two to three orders of magnitude from the ultraviolet (UV-B, 280 nm) to the near-infrared (1400 nm) spectral regions.

Absorbers in the near-UV/visible wavelength range are vitamin A and riboflavin. In the visible wavelengths the dominating chromophores are oxy- and deoxyhaemoglobin (Figure 9). The absorption spectrum of oxy-haemoglobin shows three peaks: a dominant peak in the blue region (Soret band, near 405 nm) and two further peaks in the green-yellow region (500-600 nm), at 540 and 580 nm, respectively (the combination of the blue and green-yellow bands cause haemoglobin to appear red); deoxyhaemoglobin strongly absorbs near 430 nm and has a weak absorption band at 550 nm (Anderson *et al.*, 1982; Parrish and Jaenicke 1982; Cheong *et al.*, 1990).

Aside from melanin, other biologically relevant absorbers in the visible range are porphyrins. Although abundant in all tissues, water is not a significant absorber of light in the visible region, but absorbs UV (decreasing with increasing wavelength) and infrared radiation (increasing with increasing wavelength).

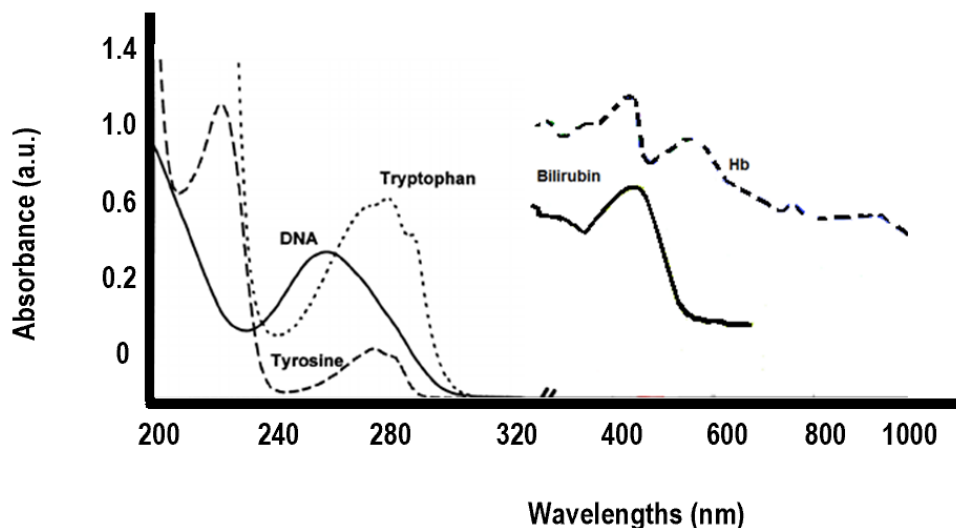

**Fig. 9: The absorption spectra of different biological chromophores in human skin (source: R.M. Ion)**

### 6.6.3 Penetration of light in the skin

The penetration depth of light in the skin is a function of wavelength and absorption/scattering by skin components (e.g. melanin, keratin, collagen, haemoglobin and fat). In the visible wavelength range, penetration depth increases with increasing wavelength.

#### *Penetration of light in the skin according to skin layers composition*

Each skin layer has a different thickness; the stratum corneum is ~20  $\mu\text{m}$ , the epidermis (the blood free layer), is ~100  $\mu\text{m}$ , but thickness varies, largely depending on body site, and the dermis is 1–4 mm thick (vascularized layer). The average scattering properties of the skin are defined by the scattering properties of the reticular dermis because of the relatively large thickness of the layer and of the comparable scattering coefficients of the epidermis and the reticular dermis (Genina and Tuchin, 2011).

The subcutaneous adipose tissue (1-6 mm thick depending of the body site) has absorption defined by absorption of haemoglobin, lipids, and water (about 11%) (Jacques, 2013).

*Epidermis* – the epidermis has an important function in absorbing most of the short-range UV-B (280-315 nm) and a significant proportion of UV-A (315-400 nm) radiation. This results both from absorption of UV radiation by melanin and urocanic acid, and from scattering by keratins. An efficient protection against UV is afforded by the thickening of the stratum corneum that results from the epidermal hyperplasia triggered by UV exposures.

*Dermis* – the dermis is mainly constituted from collagens and elastin and is highly vascularized. Light is absorbed by haemoglobin and scattered by the large collagen fibres (about 10 times larger than keratin of the epidermis).

*Sub-cutaneous tissue* – the sub-cutaneous tissue is rich in fat and is vascularized. Fat is a highly diffusing optical medium, and haemoglobin absorbs light in blood vessels. But penetration depth of visible light (400-700 nm) in the skin is limited to about 3 mm, and only a small proportion of visible light penetrates sub-cutaneous tissue.

#### *Penetration of light in the skin according to wavelength*

*UV* – Most UV-B incident on the skin is blocked by the epidermis. It is usually considered that only 10% of UV-B reaches the basal layer of the epithelium as opposed to 50% of UV-A. UV-A reaches the dermis.

*Visible light* – For visible wavelengths (~400-700 nm) one penetration depth, i.e. when 37% of the incident energy is left, ranges between ~0.1 and 0.8 mm (very fair skin) (Kohen et al, 1995).

According to Johnson and Guy (1972), for a sample consisting of epidermis and dermis, the depth of penetration is 0.15–0.2 mm (wavelength 632.8 nm) and 0.21–0.4 nm (wavelength 675 nm).

*Infrared* – infrared radiation can reach subcutaneous tissue. At wavelengths from 600 to 1500 nm, scattering prevails over absorption and penetration depth is increased to 8–10 mm.

### **6.7 Optical radiation effects on skin**

The topic is reviewed in the SCENIHR Opinion “Health Effects of Artificial Light” (SCENIHR, 2012). A brief version containing some new information published since 2012 can be found in Annex III.

The SCHEER is unaware of UV-LED sources intended for the general population with the exception of a few devices for certain cosmetic purposes (see Annex III). UV nail lamps and/or LEDs do not appear to significantly increase the lifetime risk of non-melanoma skin cancer. However, data are lacking regarding the possibility of premature skin ageing, and the risk to the eyes of the professional operators should be considered. Assessment of LED sources in medical devices and for occupational use is beyond the scope of this Opinion.

Vitamin D production in human skin following exposure to UV irradiation from LEDs has been studied *in vitro* via High Performance Liquid Chromatography indicating possibility for synthesis of vitamin D2 and vitamin D3 if the UV LED source is powerful enough. However, UV-B is carcinogenic to humans, and public health organizations, including



SCHEER (SCHEER, 2016) do not recommend use of artificial UV radiation to enhance vitamin D levels.

## 6.7.2 Effects of LED reported in the literature (photodermatoses)

### 6.7.2.1 Controlled studies

A controlled study (Fenton *et al.*, 2013) investigated photosensitivity after exposure to either a single-envelope compact fluorescent lamp (CFL) (15 W GE BIAXTM Electronic 220–240 V; 50/60 Hz; 120 mA; FLE TBX/XM827 183 JA/S; 900 lumen), a double-envelope CFL (15 W OSRAM DULUXSTAR Mini Ball 827 Lumilux Warm White 220–240 V; E27; 50/60 Hz; 850 lumen) or an LED lamp (10 W 0026172 Hi-Spot RefLED PAR30; E27; 15 000 h; 100–250 V; 50–60 Hz; 20 lm Warm White 830/3000 K; 400 lumen). The emission spectra of the lamps between 250–400 nm at the distance of patient testing were recorded and presented. Two hundred patients (103 actively photosensitive) were exposed to the single-envelope CFL and of these, 11 patients were exposed to the double-envelope CFL. One hundred and one patients (45 actively photosensitive) were exposed to the LED and, in addition, there were 20 healthy controls. The patients were exposed on untanned skin on the inner forearm while the healthy controls were exposed on untanned skin on the back. All subjects were at a distance of 5 cm from the lamp. One of the exposure sites was covered with UVR-protective film. In the CFL-group 32 patients presented with responses (delayed papules, erythema and immediate urticarial responses), while in the LED-group one patient showed a response. Two of the healthy volunteers showed a positive erythematous response 24 h post-irradiation. The patient showing a positive response in the LED-group was diagnosed with solar urticaria and had visible light sensitivity. The SCHEER notes that the LED irradiance in the full emission range was unknown. The LED's UV emission was negligible compared to those of the CFLs.

A pilot study (Fenton *et al.*, 2014) investigated the exposure of a compact fluorescent lamp (CFL) (GE BiaxTM Electronic, part number FLE15TBX/XM/827, 220–240 V, 50–60 Hz, 15 W, 120 mA, 900 lumen (GE Lighting, Northampton, U.K.), an energy-efficient halogen lamp (EEH) (Osram Halogen ES Classic Spot R63, part number 64546 R63 ES, 240 V, 42 W, 630 lumen (Osram, Munich, Germany) and an LED (Hi-Spot RefLED PAR30, part number 0026172, 100–250 V, 50–60 Hz, 10 W, 400 lumen (Sylvania, Raunheim, Germany). The emission spectra of the lamps between 250–400 nm at the distance of patient testing were recorded and presented. Fifteen patients with lupus erythematosus (LE) and five healthy volunteers were included and tested for cutaneous responses to repeated exposures from the lamps. The patients were exposed on untanned skin on the back at a distance of 5 cm from the lamp. One of the exposure sites was covered with UVR-protective film. The authors reported that: "No cutaneous LE lesions were induced by any of the light sources. Delayed skin erythema was induced at the site of CFL irradiation in six of the 15 patients with LE and two of the five healthy subjects. Erythema was increased in severity and was more persistent in patients with LE. One patient with LE produced a positive delayed erythema to the EEH. A single patient with LE produced immediate abnormal erythematous responses to the CFL, LED and EEH. Further investigation revealed that this patient also had solar urticaria. All other subjects had negative responses to LED exposure". The SCHEER notes that the LED irradiance, for which UV-emission was negligible compared to those of the CFL and EEH, in the full emission range was unknown.

### 6.7.2.2 Case reports

A case of solar urticaria triggered by LED-therapy was reported by Montaudié *et al.* (2014). A 55-year-old woman with no history of urticarial rash following previous sun exposures was treated with 415 nm LED for mild rosacea (a photo-aggravated dermatosis). Phototesting confirmed the diagnosis of solar urticaria. The SCHEER notes that the irradiance, treatment distance and LED-spectrum were not reported.

A case was reported of a patient with cutaneous lupus erythematosus (CLE) who presented with a rash after dental treatment (Tiao *et al.*, 2015). The patient was allegedly being exposed to "surgical light" emitting UV-B, a wavelength range without purpose for this type of light. The SCHEER notes the spectral characteristics of the source were not given. It is unknown whether her reaction alternatively could have been due to an (photo-)allergy to dental materials, heat effects from the emission of blue light from LED dental curing lights (irradiance typically in the order of thousands mW/cm<sup>2</sup>) or a drug-mediated photosensitivity reaction (the patient took several medications for her disorder).

### 6.7.3 Conclusions

Emission from some types of commercial LED lighting can induce a positive skin response in some patients with solar urticaria when exposed in short distances and at high intensities (compared to e.g. indoor lighting) in controlled environments. The dose that elicits such a response is not known.

## 6.8 Circadian rhythms

Apart from influencing vision, light received by the eye has several non-image-forming functions, such as the pupillary light reflex and providing input to the biological clock. This biological timekeeping system imposes day-night rhythms on many processes in our body, including behaviour (sleep/wake cycle), endocrine regulation, immune response and energy metabolism. Disturbances of our circadian rhythms caused by shift work have been linked with negative effects on health and increased accident risks. The biological clock is highly influenced by external light clues, including artificial light. These results were previously reviewed in the SCENIHR Opinion 'Health effects of artificial light' in 2012. In the current Opinion, the SCHEER focusses on the effects of LED sources. For a summary of the mechanism of generation of circadian rhythms and their normal functions, see Annex V.

### 6.8.1 Synchronisation and regulation of the circadian rhythm by light

The influence of light on the circadian system is dependent on 1) timing, 2) intensity, 3) duration, 4) spectrum of the light stimulus, and 5) of previous light exposure. For intensity and duration, experiments have shown that there is a dose-dependent relationship with response of the circadian system (Duffy and Czeisler 2009). Importantly, relatively low intensity levels (<100 lux) and short durations (seconds to minutes) have been reported to affect the circadian system (Glickman, Levin *et al.* 2002, for review see Duffy and Czeisler 2009, Lucas, Peirson *et al.* 2014). With regard to timing and previous light exposure, light stimuli have a greater impact on the circadian system when they are present during the natural dark phase. Light present during the late night/morning will advance the phase of the circadian rhythm, whereas light present during the evening will delay the phase of the circadian rhythm. This is an important concept considering disturbances of the circadian rhythm since chronic light exposure during the evening, causing a phase delay, can result in social jetlag (see 6.8.4: 'Consequences of disturbance of the circadian rhythm by light'). Furthermore, the effect of light is dependent on previous light exposure, since adaptation to light also occurs

with regard to the circadian system (Duffy and Czeisler 2009, Kozaki et al. 2016). Finally, the photoreceptors are not equally sensitive to all wavelengths of light; therefore, the spectrum of the light is critical.

Melanopsin was discovered about 19 years ago, and has since been shown to be expressed in intrinsically photosensitive retinal ganglion cells of the retina (ipRGCs) and to play an important role in providing input to the circadian system and other non-image-forming functions (Hattar, Liao et al. 2002, Duffy and Czeisler 2009, Hatori and Panda 2010, Tosini, Ferguson et al. 2016). *In vitro* experiments have shown that melanopsin has a peak spectral sensitivity of around 480 nm (Panda, Provencio et al. 2003, Panda, Nayak et al. 2005, Qiu, Kumbalasisiri et al. 2005, Torii, Kojima et al. 2007, Bailes and Lucas 2013). However, *in vivo*, the signals received in ipRGCs from the other photoreceptors also have a role in determining ipRGCs output and the subsequent input to the circadian system. Their relative contribution is still under investigation, which is compounded by the finding that this appears to be context dependent (Lucas, Peirson et al. 2014). Additionally, the spectral composition of the light that is received by the photoreceptor is influenced by the spectral transmission properties of the ocular media, which is, for example, dependent on age (Lucas, Peirson et al. 2014, Gimenez, Beersma et al. 2016). In summary, spectral sensitivity of the circadian system is a complex interplay of external and internal factors, and not yet completely understood. However, experiments have shown that, overall, circadian rhythms are more affected by short wavelength light (460-490 nm) (Duffy and Czeisler 2009, Benke and Benke 2013), with the exact peak probably dependent on the individual and context involved.

### **6.8.3 Influence by optical radiation including LEDs**

For details on how human circadian rhythms are investigated in most of the described studies (such as assessing melatonin rhythms), please see Annex V. As described above, the circadian system is regulated by light input. The circadian system is not only influenced by natural light, but also by optical radiation from artificial light sources. Some artificial lighting sources influence the circadian system and, dependent on the timing, support or compete with natural light as a zeitgeber. For example, studies using exposure to artificial light sources reported effects on melatonin rhythms and subsequent sleep (for example, Wright, Lack et al. 2001, Wright, Lack et al. 2004, Cajochen, Frey et al. 2011, Wood, Rea et al. 2013, Chang, Aeschbach et al. 2014, Gronli, Byrkjedal et al. 2016, Rangtall, Ekstrand et al. 2016). This might have health consequences when artificial light is present during the evening and night time, when naturally no light is present. Exposure to light during the evening and night may delay the phase of the circadian clock. This delay might cause a disturbance of the circadian rhythm: see section 'Consequences of disturbance of the circadian rhythm by light' in Annex V for more details. These effects can occur with all types of artificial light, however, recent studies indicate that this effect is amplified for certain types of LEDs.

#### **6.8.3.1 Disturbance of the circadian rhythm by LEDs sources**

The widespread use of LEDs is relatively recent. Therefore, only a small number of studies investigated the effects of LEDs vs. traditional light sources during the evening on circadian rhythms. It is important to note that LEDs, as traditional light sources, are not one homogenous class; their influence on the circadian system depends on the specific properties of that particular light source. Some studies have investigated the effect of (blue) LEDs on circadian rhythms and (objective) sleep without a comparison to traditional light sources (for example, Wright, Lack et al. 2004, Kayaba, Iwayama et al. 2014), which indicated that LEDs that emit short-wavelength light influence circadian rhythms, as do other light sources with short-wavelength light.

Most of the few studies available investigated screens illuminated by LEDs. For example, a study from Cajochen et al. investigated the effect of evening exposure to white light from a commercially-available screen illuminated with LEDs (6953K) or a cold cathode

fluorescent lamp (CCFL 4775K) illuminated screen (Cajochen, Frey et al. 2011). Spectral measurements were performed showing that the radiance between 400 nm and 480 nm of the LED screen was higher ( $0.241 \text{ W}/(\text{sr}\cdot\text{m}^2)$ ) compared to the CCFL illuminated screen ( $0.099 \text{ W}/(\text{sr}\cdot\text{m}^2)$ ). Participants were asked to watch this screen in a controlled laboratory setting for 5 hours during the evening. Relative to the non-LED screen, the LED screen delayed the dim light melatonin onset (DLMO) and enhanced the suppression of evening melatonin levels for approximately 2 hours. In addition, exposure to the LED screen reduced subjective and objective measures of sleepiness and increased performance on cognitive tasks, relative to the non-LED screen. These results indicate that exposure to screens illuminated with these types of LEDs have a larger immediate influence on the circadian system than the CCFL-illuminated screen.

A study from Wright *et al.* similarly showed that LEDs can phase delay the circadian rhythm in melatonin levels (Wright, Lack et al. 2001). However, in this study the phase delay caused by this type of white LED was not different to the phase delay caused by a traditional white fluorescent light source. In this study, a blue/green LED was also included, which did affect the circadian rhythm in melatonin to a greater extent compared to the white LED or white fluorescent light source. The authors report that the white LED has a narrow peak wavelength at 460 nm and a secondary broader peak wavelength at 560 nm. The blue/green LED has a peak wavelength at 497 nm and a half-peak bandwidth of 485-510. Exposure to the light sources was performed for 2 hours during night time (from 24.00 - 02.00 h). Hence, exposure started when melatonin levels were already high. This is in contrast to the study by Cajochen *et al.*, where exposure was during the evening when melatonin levels start to rise and for a longer period (5 hours). All light sources suppressed the melatonin levels between 24.00 and 02.00 hours. In all experimental groups with an additional light source, a phase delay of the melatonin rhythm was observed the subsequent day. Exposure to light from blue/green LEDs caused the largest delay of 42 minutes. The delay observed after exposure to the fluorescent light box and white LEDs was similar (both 22 minutes). In summary, this study shows that all of the used light sources influenced the circadian rhythm of melatonin with the blue/green LEDs having a greater effect.

Similar findings were observed in a second study in which exposure to light from blue LEDs was compared to white fluorescent light (West, Jablonski et al. 2011). In this study, irradiance of the blue LEDs ranged from  $0.1 - 600 \mu\text{W}/\text{cm}^2$ ; irradiance of the white fluorescent light was  $40 \mu\text{W}/\text{cm}^2$ . Results show that there is increased melatonin suppression with increased radiance from blue LED light. Additionally, blue LEDs affect melatonin levels at lower radiances compared to white fluorescent light.

Combined, these studies indicate that any additional influence on the circadian system by LEDs is dependent on the characteristics of the emitted optical radiation and of the use of the LEDs (i.e. timing and duration) in a similar fashion as other light sources influence the circadian system. It is important to note that LEDs might have a beneficial emission spectrum compared to traditional light sources as well (Aube, Roby et al. 2013, Lu, Chou et al. 2016). Effects are depending on the time of day, of exposure and on the characteristics of the LEDs. For example, increased exposure to blue light during the day will enhance circadian rhythms.

Additionally, there are a few studies that investigated the effect of 'real life' devices in which LEDs are incorporated, such as tablets (Wood, Rea et al. 2013, Chang, Aeschbach et al. 2014, Gronli, Byrkjedal et al. 2016, Heo, Kim et al. 2016, Rangtell, Ekstrand et al. 2016). In these studies, no controls with non-LED devices were made. However, these studies provide some insight to the effects that occur in real life, where the use of screens illuminated by LEDs has increased tremendously over the recent years (Gradisar, Wolfson et al. 2013). Most of these studies observed effects on melatonin onset, levels, sleepiness and/or sleep quality. In one of the studies, no effects of screen use were observed (Rangtell, Ekstrand et al. 2016). In this study, the effect of reading

with a self-luminous tablet or reading an ordinary book for 2 hours during the evening was compared. The 'reading an ordinary book' is an important control group, since it controls for the level of (cognitive) activity performed regardless of light. The authors suggest that the lack of effect in their study might be due to bright light exposure during the day for 6.5 hours (Rangtall, Ekstrand et al. 2016). No control group for prior light exposure was included in any of these studies.

The study by Chang *et al.* (2015) was the first to investigate repeated exposure (for 5 consecutive days) to an LED illuminated screen on circadian rhythms. Similar to the study by Rangtall et al, reading a book using an iPad® or an ordinary book was compared. However, in this study reading occurred for 4 hours before going to sleep and a dark adaptation was included for 2 hours beforehand. Effects were observed on melatonin levels, time to fall asleep, subjective and objective sleep measures and sleepiness levels on the morning after. After 5 days of using the iPad® an average delay of the melatonin rhythm of 1.5 h compared to reading an ordinary book was observed on day 6.

The study by Figueiro *et al.* (2016) investigated the effect of self-luminous devices in the evening in a home-setting. Adolescent participants (15-17 years old) were asked to wear orange-tinted glasses for 1 hour or 3 hours before bedtime while using any type of self-luminous device for 3 hours. The orange-tinted glasses blocked exposure to short-wavelength light. Melatonin levels were lower when orange-tinted glasses were worn only during the first hour compared to wearing the glasses during all 3 hours of using the self-luminous devices (Figueiro *et al.*, 2015).

In summary, the available studies indicate that white-light LEDs can have larger influence on the circadian rhythm compared to traditional light sources, due to their different spectral emission pattern. Light sources that emit more short-wavelength light, as do most white LEDs, will have a larger effect on the circadian system at equal intensity, duration and timing and after equal previous light exposure. Recently, however, new LEDs have become available that emit lower levels of short-wavelength light, which might decrease effects in the future when use of these LEDs is more widespread. In addition, it is unclear if the effects on the biological clock remain with repeated exposure as occurs in real life. Furthermore, it is important to note that exposure to light with high levels of short-wavelength during the day might enhance entrainment of the circadian clock and attenuate the effect of evening light exposure. It should be mentioned here that several studies present significant limitations in terms of dosimetry. Finally, it is important to note that most of the research described in this section was conducted on screen use and not on lighting in general.

#### **6.8.4 Consequences of disturbance of the circadian rhythm by light**

The studies described above showed that influence of artificial light sources on the circadian rhythm is dependent on the characteristics of the emitted optical spectral radiance. Several of the LEDs investigated in these studies have a larger effect on circadian rhythms compared to traditional light sources, due to their different spectral emission patterns. Currently, there are no studies that investigated the health consequences of use of LEDs during the evening and night. For negative consequences reported for other artificial light sources, please see Annex V.

#### **6.8.5 Vulnerable and susceptible populations**

It is known that elderly persons have less robust circadian rhythms (Cornelissen and Otsuka 2016) and might, therefore, be more susceptible to circadian disturbance caused by artificial light in general. In addition, adolescents are known to more often have a late chronotype (Roenneberg, Kuehnle et al. 2007). Combination of a late chronotype with artificial light exposure during the evening might result in enhanced effects on sleep.

### 6.8.6 Conclusions

The currently available studies indicate that artificial light can influence the circadian system, depending on the light characteristics. Light sources that emit more short-wavelength light, as do some types of LEDs, will have a larger effect on the circadian rhythms at equal optical radiance, duration and timing of exposure. Exposure during the evening might result in changed sleep patterns and other adverse effects, although evidence is limited. Several studies suggest a link between desynchronisation of the biological clock and increased metabolic risk factors. However, it is unclear if chronic artificial evening light can cause these effects.

However, the current conclusion is based on a limited amount of studies, which were mostly performed in a laboratory setting. An important question that remains is whether light from LEDs and artificial light in general, present in indoor lighting and screens, will have an effect on the circadian system in *real life*. Moreover, it is currently unknown if the effects on the circadian system remain, enhance or reduce, after repeated and ultimately after chronic exposure, such as currently occurs in real life.

### 6.9 Temporal Light Modulation (Flicker) and potential health effects

Most light sources operating from the electrical mains tend to have a degree of temporal modulation. However, sources such as incandescent lamps have thermal inertia, which means that the degree of modulation is limited to about 10%. LEDs operated from DC sources will not flicker unless modulation is introduced, for example to increase perceived brightness. LEDs operating from mains supplies (50 Hz in Europe) may have a degree of modulation ranging from less than 10% to 100%. Such modulation may also be introduced by dimming systems.

Flicker is usually used to represent modulation of the light source that can be perceived. Some people are susceptible to photosensitive epilepsy, which may be triggered by light modulation or rapidly changing images. The susceptibility is a function of flicker frequency and possibly the proportion of the field of view occupied by the actual or virtual source (which may include reflections from surfaces). Photosensitive epilepsy has an overall incidence of 1.5/100,000 per year, which increases between the ages of 7 and 19 years, to seven per 100,000 per year (Quirk *et al.*, 1995). Concerns over exposure to flashing images on screens have existed since before the use of LEDs in screen technology (Wilkins *et al.*, 2004). No published studies were identified to suggest increased reporting of symptoms as a result of LED technology. The usual trigger of concern for sufferers of photosensitive epilepsy is strobe-like lighting, as used in entertainment, or as experienced when driving through an avenue of trees with the sun to the side. However, there was one recent case study (Brna and Gordon, 2017) of an adolescent who had symptoms triggered by the multiple flash (to reduce "red eye") from a smart phone camera.

Under a flicker/strobe rate of about 5 Hz and above about 60 Hz, the proportion of patients with photosensitive epilepsy who this might cause to have an episode is less than 5%, with the peak sensitivity at about 20 Hz (Binnie *et al.*, 2002).

Area lighting operating from the mains may exhibit temporal light modulation (TLM), sometimes referred to as flicker, at 100 Hz (in Europe), which is above the frequency of concern for photosensitive epilepsy. However, depending on the degree of modulation, some people may perceive the flicker, especially in the peripheral field of view. Although no published case-studies were identified, there are claims that a small number of people are very sensitive to TLM at about 100 Hz, triggering symptoms such as headaches, migraine and general malaise. The Figure shows the LED lighting assessed in the home of a patient suffering from migraine and face burning when in the vicinity of



their kitchen LED down-lighters. Figure 10 shows the lighting operating at full brightness (100%) and when set to 50% on a dimmer switch.

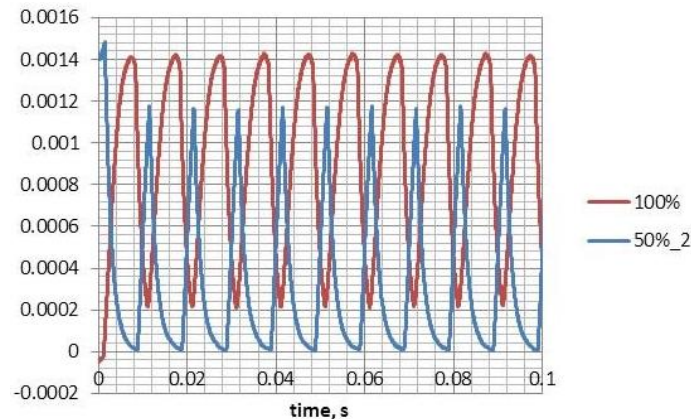

**Fig. 10: Light emission measured in arbitrary units as a function of time for an LED operating at full output and at the 50% setting on a dimmer switch (source: John O'Hagan, 2017)**

Spectra for the different LED lighting in the kitchen/dining room area are shown in Figure 11, demonstrating that the spectra are similar.

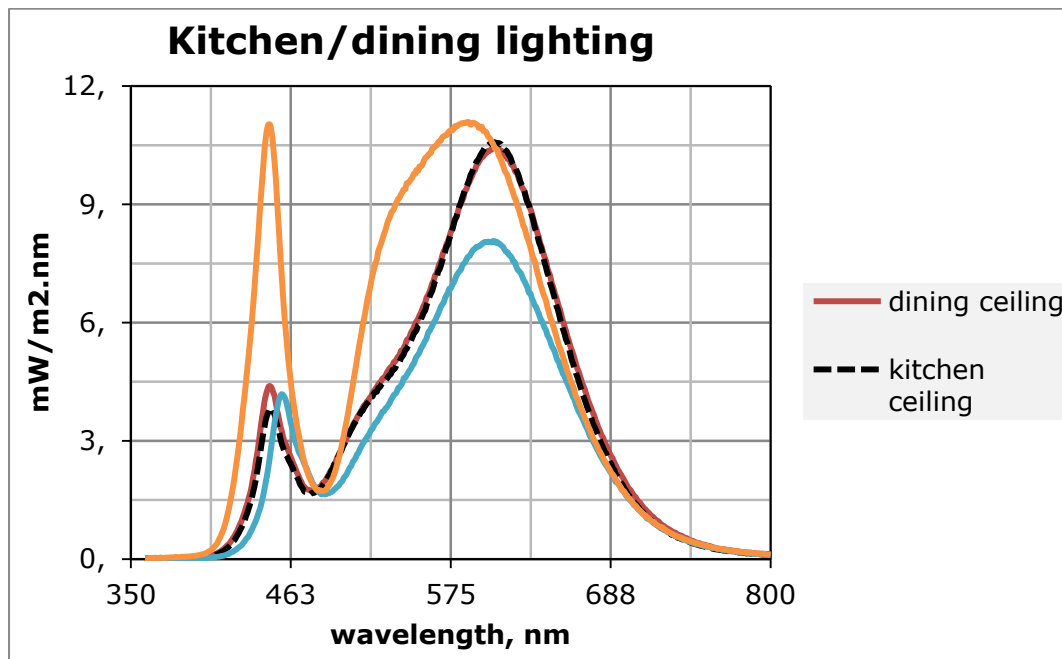

**Fig. 11: Emission spectra for domestic LED installations in a kitchen (source: John O'Hagan, 2017)**

The Institute of Electrical and Electronics Engineers (IEEE) in the US published the IEEE Recommended Practices for Modulating Current in High-Brightness LEDs for Mitigating Health Risks to Viewers in 2015 (IEEE, 2015). This document provides a plot of the risk of adverse health effects as a function of frequency and percentage modulation.

As the modulation frequency increases, another effect is likely, called the phantom array, an example of a temporal light artefact. This is often experienced when travelling behind a car at night. If the car has LED brake or other rear lights, a sudden eye movement can result in a series of images of the source. The effect can also be

produced when driving past a static source exhibiting TLM, such as LED road studs (cat's eyes). Roberts and Wilkins (2013) showed that phantom arrays can be perceived at modulation rates up to about 2 kHz, and possibly higher under some circumstances for some viewers. It is possible that some of the susceptibility to high frequency (100 Hz and above) TLM may be due to the phantom array, even if the array is not perceived.

A major concern following the introduction of fluorescent lamps in industry was the stroboscopic effect, sometimes referred to the "wagon-wheel" effect, where a rotating object appears static. This was addressed in industry by ensuring that fluorescent lamps were on different phases and/or incandescent task lighting was used. LED lighting can produce the same effect, depending on the degree of modulation. However, of greater concern is the use of modulated LED lighting in domestic and other non-industrial environments where awareness is likely to be low. It is reasonably foreseeable that a rotating food mixer blade could appear stationary when the only illumination source is a modulated LED, or a group of LEDs operating at the same frequency.

The International Commission on Illumination organised a workshop in February 2017 to consider the implications of temporal light modulation, and how to quantify both the hazard and the risk (CIE, 2017).

It is possible to operate LEDs from essentially DC power supplies. However, even when the temporal light modulation is assessed for a given LED luminaire, there appears to be no guarantee that similar luminaires, even with the same part number, will be identical (CIBSE, 2016).

### 6.9.1 Conclusion

LED lighting can produce a stroboscopic effect, depending on the degree of modulation. The use of modulated LED lighting in domestic and other non-industrial environments where awareness is likely to be low is of a concern. Although no published case studies were identified, there are claims that a small number of people are very sensitive to temporal light modulation at about 100 Hz, triggering symptoms such as headaches, migraine and general malaise.

### 6.10 Exposure and health risk scenarios

- Exposure situations in various indoor LED lighting settings

Many people spend significant proportions of the day and evening (and possibly night) staring at screens, which may be LED illuminated. Television screens tend to be viewed at distances of 1 metre or more, computer screens at about 50 cm and tablets or phones viewed at closer distances. There are also applications where a dedicated screen or a smartphone may be viewed within a few centimetres, for example in virtual reality headsets. O'Hagan *et al.* (2016) assessed the emissions from various screens and concluded that exposure levels were less than 10% of the ICNIRP blue light exposure limit, even for extended use durations. Since the assessment was carried out in terms of source radiance, the assessment conclusion was made independent of viewing distance.

The blue light photochemical retinal hazard to the eye from domestic LED lighting is between 10-20% (compared with 14% for a mid-range incandescent lamp) of the relevant ICNIRP exposure limit, assuming viewing longer than about 3 hours) (O'Hagan *et al.*, 2016).

- Exposure situations in various outdoor LED lighting settings (streets)

Many street lights and other street fixtures are being converted to, or replaced with, LED lighting. The main driver for this is energy saving. However, if this factor alone is



considered, there are claims that LED lighting may be installed that is poor quality in terms of the emission spectrum, illumination, light pattern and glare.

Correlated colour temperature (CCT) is a measure of the blueness of an optical radiation source: the higher the CCT, the more blue-rich the source is. CCT is the temperature of a Planckian radiator that is the closest match to the emission of the source (CIE, 2011). The CCT of LED street lighting varies from about 7000 K down to about 2700 K. When compared with the sodium lamps that many LED street lights are replacing, the high CCT installations can appear harsh and almost equivalent to daylight. Moonlight has a CCT of about 4000 K, so it could be argued that artificial street lighting should not exceed this value. However, it is important that the lighting installation is appropriate for the use of the road (e.g., motorways may justify higher CCT lighting than residential roads).

Glare can occur from two main scenarios: the luminance may be too high or the luminance ratios are too high (IES, 2011). Unless it is the purpose of the source, it is good lighting practice to ensure that the source is diffused or shielded from direct viewing to avoid glare. Some LED street lights have exposed LED elements that can be seen by road users within their normal field of view, such as when they are looking ahead. Such sources may contribute to discomfort glare (IES, 2011). Where the LED elements were recessed or diffused in order to reduce the luminance, such concerns were not reported.

Vehicle LED lights, and particularly daylight running lights and headlights, can be a source of either discomfort glare or disability glare. The latter is due to scattering of the light in the eye and in the environment, and is more prevalent for sources emitting high levels of blue light and for older observers. The sources may also produce a higher level of glare during fog. No references were identified with quantified assessments of these issues.

### **6.11 Overall conclusion:**

The SCHEER concludes that there is no evidence of direct adverse health effects from LEDs in normal use (lighting and displays) by the general healthy population. Some people report that they are sensitive to temporal light modulation from LEDs.

Children have a higher sensitivity to blue light and although emissions may not be harmful, blue LEDs (between 400 nm and 500 nm) may be very dazzling and may induce photochemical retinopathy, which is a concern especially for children below three years of age. Older people may experience discomfort with exposure to light that is rich in blue light.

Either discomfort glare or disability glare can be temporarily caused by vehicle LED lights, and particularly daylight running lights and headlights.

Light sources that emit more short-wavelength light, as do some types of LEDs, will have a larger effect on the circadian rhythms at equal optical radiance, duration and timing of exposure. At the moment, it is not yet clear if this disturbance of the circadian system leads to adverse health effects.

## 7. RECOMMENDATIONS FOR FUTURE WORK

The review of the published research conducted by the SCHEER has led to valuable conclusions and identified certain gaps in knowledge on potential risks to human health from LEDs. These gaps could be partially filled if further research is carried out to elucidate unresolved problems as follows:

### Effect on the eyes

There is insufficient knowledge about the actual exposure of people to optical radiation from LED sources and the total exposure from all optical radiation sources – information about the exposure of the general healthy population is needed for assessing the potential health effects. It is suggested that the exposure assessments should consider different age groups, i.e. babies, young children, adolescents and adults into old age.

It was recognised that early-to-market LED lamps had a significant blue emission. Further research is going into improving LED lamps to make them similar to traditional types of lighting, such as incandescent lamps. The current EN 62471 standard does not take account of population groups particularly sensitive to blue light, hence there are no specific recommendations for population groups whose natural mechanisms for filtering blue light are diminished (children, aphakics and pseudophakics). However, it is recognised that the exposure of the general population to optical radiation from LEDs is likely to be insignificant compared with the exposure to natural light outdoors, but any additional health burden needs to be considered.

High luminance, temporal light modulation, phantom array and stroboscopic effects are other factors relevant to risk assessment that need to be addressed in further studies. In particular, are some population groups particularly susceptible to modulated emissions from LED lamps, either due to the design of the LED drive circuit or through the use of dimming circuits? The use of high luminance vehicle lighting should be investigated to determine if there are potential adverse consequences for increased accident rates.

Cumulative exposure over a twenty-four hour time period should be considered, and further research should be done into the reported effects of long-term, low-level exposure on age-related macular degeneration.

### Effects on healthy skin

Depth of skin penetration is primarily dependent upon the wavelength of the optical radiation. Research should be carried out on heat effects on the skin and the relation to skin cancer, if the use of infrared saunas/warming cabinets incorporating infrared LED sources are established. In addition, exposure and dose levels for the induction of effects for patients with certain photo dermatoses should be investigated.

### Circadian system

An important question is whether optical radiation from LEDs, and artificial light in general, which is present in indoor lighting and screens, will have an effect on the circadian system in *real life*. Research will need to consider the wavelengths of emission, time of day and duration of exposure, any confounding factors, such as the activity being carried out, prior light history and the age of subjects. Secondly, it is not yet known if the effects on the circadian system remain the same, accumulate or decrease after repeated and/or chronic exposure, such as currently occurs in real life. Moreover, it remains to be investigated if the potential disturbance of the circadian system, caused by LEDs and/or artificial light, is related to negative health effects, as appear to occur due to other circadian disturbances such as shift work.

## **8. CONSIDERATION OF THE RESPONSES RECEIVED DURING THE CONSULTATION PROCESS**

A public consultation on this Opinion was opened on the website of the Scientific Committees from 19 July to 17 September 2017. Information about the public consultation was broadly communicated to national authorities, international organisations and other stakeholders.

84 contributors (providing nearly 300 comments and 22 documents) participated in the public consultation providing input to different chapters and subchapters of the Opinion. The vast majority of comments came from the industry.

Each submission was carefully considered by the SCHEER and the Opinion has been revised to take account of relevant comments. The literature has been accordingly updated with relevant publications. Some commentators recommended editorial changes to make the Opinion and its basis clearer.

The text of the comments received and the response provided by the SCHEER is available at:

[https://ec.europa.eu/health/scientific\\_committees/consultations/public\\_consultations/sc\\_heer\\_consultation\\_05\\_en](https://ec.europa.eu/health/scientific_committees/consultations/public_consultations/sc_heer_consultation_05_en)

## 9. REFERENCES

- Ambati J., & Fowler B. J. (2012). Mechanisms of age-related macular degeneration. *Neuron*, 75(1), 26–39. <http://doi.org/10.1016/j.neuron.2012.06.018>
- Anderson R.R., Parrish J.A., Jaenicke KF (1982). Optical properties of human skin, in *The Science Photomedicine*, ed by J.D. Rogan, J.A. Parrish (Plenum Press, New York, 1982) pp. 147–194.
- Anderson R.R., Parrish J.A. (1981). The optics of human skin. *J Invest Dermatol.* 1981 Jul; 77(1):13–19. [[PubMed](#)]
- Anderson R.E., Rapp L.M., Wiegand R.D. (1984). Lipid peroxidation and retinal degeneration, *Curr. Eye Res.* 3 pp. 223–227.
- ANSES (2016). Assessment of the health risks associated with night work. <https://www.anses.fr/en/system/files/AP2011SA0088EN.pdf>.
- Argiles M, Cardona G, Perez-Cabre E, Rodriguez M (2015). Blink Rate and Incomplete Blinks in Six Different Controlled Hard-Copy and Electronic Reading Conditions. *Investigative ophthalmology & visual science.* 56(11):6679-85.
- Aube M, Roby J, and Kocifaj M (2013). Evaluating potential spectral impacts of various artificial lights on melatonin suppression, photosynthesis, and star visibility. *PLoS One* 8(7): e67798.
- Halliwell B, Gutteridge JMC (2000). *Free Radicals in Biology and Medicine.* 3rd ed. Oxford: Oxford University Press.
- Bailes HJ, and Lucas RJ (2013). Human melanopsin forms a pigment maximally sensitive to blue light) supporting activation of and signalling cascades. *Proceedings of the Royal Society B: Biological Sciences.* 280 (1759).
- Balasubramanian D (2000). Ultraviolet radiation and cataract, *J. Ocul. Pharmacol.Ther.* 16 (3) pp. 285–297
- Balwani M, Bloomer J, Desnick R. Porphyrias Consortium of the NIH-Sponsored Rare Diseases Clinical Research Network. In: Pagon RA, Adam MP, Ardinger HH, Wallace SE, Amemiya A, Bean LJH, Bird TD, Ledbetter N, Mefford HC, Smith RJH, Stephens K, eds. *GeneReviews®* [Internet]. Initial Posting: September 27, 2012. <https://www.ncbi.nlm.nih.gov/books/NBK100826/> (accessed 20 June 2017)
- Barnkob LL, Argyraki A, Petersen PM, and Jakobsen J (2016). Investigation of the effect of UV-LED exposure conditions on the production of vitamin D in pig skin. *Food Chemistry.* 212, 386–391.
- Beatty S, Koh H, Phil M, Henson D, Boulton M (2000). The role of oxidative stress in the pathogenesis of age-related macular degeneration. *Surv. Ophthalmol.* 45, 115e134.
- Behar-Cohen F, Martinsons C, Viénot F, Zissis G, Barlier-Salsi A, Cesarini JP, Enouf O, Garcia M, Picaud S, Attia D (2011). Light-emitting diodes (LED) for domestic lighting: Any risks for the eye?. *Prog Ret Eye Res.* 30:239-257
- Benke KK, and Benke KE (2013). Uncertainty in Health Risks from Artificial Lighting due to Disruption of Circadian Rhythm and Melatonin Secretion: A Review. *Human and Ecological Risk Assessment: An International Journal.* 19(4): 916-929.
- Bikle DD (2012). Vitamin D and the skin: Physiology and pathophysiology. *Rev Endocr Metab Disord.* 13:3–19.

- Binnie CD, Emmett J, Gardiner P, Harding GFA, Harrison D, and Wilkins AJ (2002). Characterising the flashing television images that precipitate seizures. *SMPTE Journal*, 323-329.
- Bornehag C.G., Nanberg E. Phthalate exposure and asthma in children. *Int J Androl*. 2010;33:333-45.
- Boulton M., Dontsov A., Jarvis-Evans J., Ostrovsky M., Svistunenko D. (1993). Lipofuscin is a photoinducible free-radical generator. *J Photochem Photobiol B-Biol*. 19:201-202
- British Standard. Classification of non-electrical sources of incoherent optical radiation. BS EN 16237:2013 Annex B.
- Brun A., Sandberg S. (1991). Mechanisms of photosensitivity in porphyric patients with special emphasis on erythropoietic protoporphyria. *J Photochem Photobiol B*. 10:285-302.
- Bullough J.D., Bierman A., Mark R. S. (2017): Evaluating the Blue-Light Hazard from Solid State Lighting, *International Journal of Occupational Safety and Ergonomics*, DOI: 10.1080/10803548.2017.1375172
- Burke T.M., Scheer F.A., Ronda J.M., Czeisler C.A., and Wright K.P. Jr. (2015). Sleep inertia, sleep homeostatic and circadian influences on higher-order cognitive functions. *J Sleep Res*. 24(4): 364-371.
- Buscemi N., Vandermeer B., Hooton N., Pandya R., Tjosvold L., Hartling L., Vohra S., Klassen T.P. and Baker G. (2006). Efficacy and safety of exogenous melatonin for secondary sleep disorders and sleep disorders accompanying sleep restriction: meta-analysis. *BMJ*. 332(7538): 385-393.
- Cajochen C., Frey S., Anders D., Spati J., Bues M., Pross A., Mager R., Wirz-Justice A., and Stefani O. (2011). Evening exposure to a light-emitting diodes (LED)-backlit computer screen affects circadian physiology and cognitive performance. *J Appl Physiol* 110(5): 1432-1438 DOI: 10.1152/jappphysiol.00165.2011
- Cancer Registry of Norway. <https://www.kreftregisteret.no/globalassets/cancer-in-norway/2015/cin-2015.pdf> (accessed 20 June 2017)
- Cedernaes J., Schioth H.B., and Benedict C. (2015). Determinants of shortened, disrupted, and mistimed sleep and associated metabolic health consequences in healthy humans. *Diabetes*. 64(4): 1073-1080.
- CENELEC (2015) EN 62115 with A.12 Electric Toys. Safety.
- CENELEC (2008) EN 62471 Photobiological safety of lamps and lamp systems.
- Chamorro E., Bonnin-Arias C., Pérez-Carrasco M.J., de Luna J.M., Vázquez D., and Sánchez-Ramos C. (2013). Effects of Light-emitting Diode Radiations on Human Retinal Pigment Epithelial Cells *In Vitro*. *Photochemistry and Photobiology*. 89: 468-473
- Chang AM, Aeschbach D, Duffy JF, and Czeisler CA (2015). Evening use of light-emitting eReaders negatively affects sleep, circadian timing, and next-morning alertness. *Proceedings of the National Academy of Sciences*. 112 (4), 1232-1237
- Cheong W.F., Prael S.A., Welch A.J. (1990). A review of the optical properties of biological tissue. *IEEE J. Quant. Electr*. 26(12), 2166-2185.
- Chou C.F., Cotch M.F., Vitale S., Zhang X., Klein R., Friedman D.S., Klein B.E., Saaddine J.B. (2013). Age-related eye diseases and visual impairment among U.S. adults. *Am. J. Prev. Med*. 45, 29e35.
- Christiansen A.L., Aagaard L., Krag A., Rasmussen L.M., Bygum A. (2016). Cutaneous Porphyrias: Causes, Symptoms, Treatments and the Danish Incidence 1989-2013. *ActaDermVenereol*. 96:868-872.

Christoffersson G., Vagesjo E., Pettersson U.S., Massena S., Nilsson E.K., Broman J.E., Schioth H.B., Benedict C., and Phillipson M. (2014). Acute sleep deprivation in healthy young men: impact on population diversity and function of circulating neutrophils. *Brain Behav Immun.* 41: 162-172.

Chu X. K., Tuo J., & Chan C.-C. (2013). Genetics of age-related macular degeneration: application to drug design. *Future Medicinal Chemistry*, 5(1), 13–15. <http://doi.org/10.4155/fmc.12.187>

CIBSE. Human responses to lighting based on LED lighting solutions. Commissioned by the Chartered Institution of Building Services Engineers and the Society of Light and Lighting. CRCE RDD 01-2016. <http://www.cibse.org/knowledge/knowledge-items/detail?id=a0q20000008I6z6> (accessed 24 April 2017).

Cicchi R, Rossi F, Alfieri D, Bacci S, Tatini F, De Siena G, Paroli G, Pini R, and Pavone FS (2016) Observation of an improved healing process in superficial skin wounds after irradiation with a blue-LED haemostatic device, *J. Biophotonics*. DOI: 10.1002/jbio.201500191

Commission Internationale de l'Éclairage (2017). Final Report. CIE Stakeholder Workshop for Temporal Light Modulation Standards for Lighting Systems. CIE TN 008, Vienna.

CIE, Commission Internationale de l'Éclairage (2011). CIE S 017/E: 2011, ILV: International Lighting Vocabulary. CIE, Vienna.

CIE, Commission Internationale de l'Éclairage (2011). <http://eilm.cie.co.at/>

Commission Internationale de l'Éclairage (1998) Erythema Reference Action Spectrum and Standard Erythema Dose. Joint ISO/CIE Standard. ISO 17166:1999(E)/CIE S 007-1998, Geneva, Switzerland

Cornelissen G., and Otsuka K. (2016). Chronobiology of Aging: A Mini-Review. *Gerontology*.

Curtis J., Tanner P., Judd C., Childs B., Hull C., Leachman S. (2013). Acrylic nail curing UV lamps: High-intensity exposure warrants further research of skin cancer risk. *J Am Acad Dermatol.* 69:1069-1070.

Dahl M.V., McEwen G.N. Jr., Katz H.I. (2010). Urocanic acid suppresses induction of immunity in human skin. *Photodermatol Photoimmunol Photomed.* 2010;26:303-10.

Das P. (1991). *Laser and Optical Engineering USA*. Springer-Verlag, New York, pp: 41-42.

Davies M.J., Truscott R.J. (2001). Photo-oxidation of proteins and its role in cataractogenesis, *J. Photochem. Photobiol. B*, 63 pp. 114–125

Delcourt C., Cougnard-Gregoire A., Boniol M., Carriere I., Dore J.F., Delyfer M.N., Rougier M.B., Le Goff M., Dartigues J.F., Barberger-Gateau P., Korobelnik J.F. (2014). Lifetime exposure to ambient ultraviolet radiation and the risk for cataract extraction and age-related macular degeneration: the Alienor Study. *Invest. Ophthalmol. Vis. Sci.* 55, 7619e7627.

Dermatology Information System (DermIS, University of Heidelberg and University of Erlangen, Germany). <http://skincancer.dermis.net>. Accessed 18.01.2017

Dibner C., Schibler U. and Albrecht U. (2010). The mammalian circadian timing system: organization and coordination of central and peripheral clocks. *Annu Rev Physiol.* 72: 517-549.

Diffey B.L. (2012). The risk of squamous cell carcinoma in women from exposure to UVA lamps used in cosmetic nail treatment. *Br J Dermatol.* 2012 Nov;167(5):1175-8. doi: 10.1111/j.1365-2133.2012.11107.x. Epub 2012 Oct 5.

- Dijk, D. J. and S. N. Archer (2009). "Light, sleep, and circadian rhythms: together again." *PLoS Biol* 7(6): e1000145.
- Dillon J., Atherton S.J. (1990). Time resolved spectroscopic studies on the intact human lens, *Photochem. Photobiol.*, 51 (4), pp. 465–468
- Dontsov A.E., Glickman R.D., Ostrovsky M.A. (1999). Retinal pigment epithelium pigment granules stimulate the photo-oxidation of unsaturated fatty acids. *Free RadicBiol Med.* 26:1436-1446.
- Dowdy J.C., Sayre R.M. (2013). Photobiological safety evaluation of UV nail lamps. *Photochem Photobiol.* 89: 961–967.
- Duffy J.F. and Czeisler C.A. (2009). Effect of Light on Human Circadian Physiology. *Sleep Med Clin.* 4(2): 165-177.
- European Commission (1996). *Guidance on Risk Assessment at Work.* Luxembourg. ISBN 92-827-4278-4
- European Commission (2015). *EU general risk assessment methodology.* Document 2015-IMP-MSG-15.
- Elder G., Harper P., Badminton M., Sandberg S. and Deybach J.C. (2013). The incidence of inherited porphyrias in Europe. *J Inherit Metab Dis.* 36:849-57.
- Employment Social Affairs and Inclusion. Available online: <http://ec.europa.eu/social/>
- Engle-Friedman M. (2014). The effects of sleep loss on capacity and effort. *Sleep Sci* 7(4): 213-224.
- Farinola G.M., Ragni R. (2011). Electroluminescent materials for white organic light emitting diodes. *Chem Soc Rev.* 40:3467-82.
- Fenton L., Dawe R., Ibbotson S., Ferguson J., Silburn S., Moseley H. (2014). Impact assessment of energy-efficient lighting in patients with lupus erythematosus: a pilot study. *Br J Dermatol.* 170(3):694-8.
- Figueiro M., Overington D. (2016) Self-luminous devices and melatonin suppression in adolescents. *Lighting Res. Technol.* (48):966–975. Published online before print 6 May 2015, doi: 10.1177/1477153515584979
- Fenton L., Ferguson J., Ibbotson S., Moseley H. (2013). Energy-saving lamps and their impact on photosensitive and normal individuals. *Br J Dermatol.* 169(4):910-5.
- Fitzpatrick T.B. (1975). Soleil et peau [Sun and skin]. *Journal de Médecine Esthétique* (in French) (2): 33–34.
- Fitzpatrick T.B. (1988). The validity and practicality of sun-reactive skin types I through VI, *Archives of Dermatology.* 124 (6): 869–871.
- Flohil S.C., van der Leest R.J., Dowlathshahi E.A., Hofman A., de Vries E. and Nijsten T. (2013). Prevalence of actinic keratosis and its risk factors in the general population: the Rotterdam Study. *J Invest Dermatol.* 133:1971-8.
- Foote C.S. (1976) Singlet oxygen. In: Pryor WA (ed), *Free Radicals in Biology.* New York: Academic Press.
- Genina E.A., and Tuchin V.V. (2011). Optical properties of skin, subcutaneous, and muscle tissues: a Review *J. Innovative Opt. Health Sci.* 49–38
- Ghiasvand R. (2016). *Sunscreen use, indoor tanning and risk of melanoma among Norwegian women.* PhD Dissertation. Faculty of Medicine, Oslo, Norway. ISBN 978-82-8333-305-3
- Gimenez M.C., Beersma D.G., Bollen P., van der Linden M.L. and Gordijn M.C. (2014). Effects of a chronic reduction of short-wavelength light input on melatonin and sleep patterns in humans: evidence for adaptation. *Chronobiol Int.* 31(5): 690-697.

- Gimenez M., Beersma D., Daan S., Pol B., Kanis M., van Norren D. and Gordijn M. (2016). Melatonin and Sleep-Wake Rhythms before and after Ocular Lens Replacement in Elderly Humans. *Biology (Basel)* 5(1).
- Glickman G., Levin R., and Brainard G.C. (2002). Ocular input for human melatonin regulation: relevance to breast cancer. *Neuro Endocrinol Lett.* 23 Suppl 2: 17-22.
- Godley B.F., Shamsi F.A., Liang F.Q., Jarrett S.G., Davies S., and Boulton M. (2005). Blue light induces mitochondrial DNA damage and free radical production in epithelial cells. *J. Biol. Chem.* 280, 21061–21066
- Gradisar M., Wolfson A.R., Harvey A.G., Hale L., Rosenberg R., and Czeisler C.A. (2013). The sleep and technology use of Americans: findings from the National Sleep Foundation's 2011 Sleep in America poll. *J Clin Sleep Med.* 9(12): 1291-1299.
- Green A., Cohen-Zion M., Haim A., Dagan Y. (2017) Evening light exposure to computer screens disrupts human sleep, biological rhythms, and attention abilities. *Chronobiology International.* doi: 10.1080/07420528.2017.1324878
- Gronli J., Byrkjedal I.K., Bjorvatn B., Nodtvedt O., Hamre B., and Pallesen S. (2016). Reading from an iPad or from a book in bed: the impact on human sleep. A randomized controlled crossover trial. *Sleep Med.* 21: 86-92.
- Gruber-Wackernagel A., Byrne S.N. and Wolf P. (2014). Polymorphous light eruption: clinic aspects and pathogenesis. *Dermatol Clin.*;32:315-34.
- de Gruijl F.R., Van der Leun J.C. (1994). Estimate of the wavelength dependency of ultraviolet carcinogenesis in humans and its relevance to the risk assessment of a stratospheric ozone depletion. *Health Phys.* 67:319–25
- Halliday G.M., Damian D.L., Rana S., Byrne S.N. (2012). The suppressive effects of ultraviolet radiation on immunity in the skin and internal organs: implications for autoimmunity. *J Dermatol Sci* 6:176-182.
- Harris D.M., Werkhaven J.A. (1989). Biophysics and applications of medical lasers. *Adv Otolaryngol Head Neck Surg.* 3: 91-123
- Hatori M., and Panda S. (2010). The emerging roles of melanopsin in behavioral adaptation to light. *Trends Mol Med.* 16(10): 435-446.
- Hattar S., Liao H.W., Takao M., Berson D.M. and Yau K.W. (2002). Melanopsin-containing retinal ganglion cells: architecture, projections, and intrinsic photosensitivity. *Science.* 295(5557): 1065-1070.
- Heo J.Y., Kim K., Fava M., Mischoulon D., Papakostas G.I., Kim M.J., Kim D.J., Chang K.J., Oh Y., Yu B.H. and Jeon H.J. (2016). Effects of smartphone use with and without blue light at night in healthy adults: A randomized, double-blind, cross-over, placebo-controlled comparison. *J Psychiatr Res.* 87: 61-70.
- Higlett M.P., O'Hagan J.B. and Khazova M. (2012). Safety of light emitting diodes in toys. *Journal of Radiological Protection,* 32, 51-72.
- Hillenkamp F. (1989). Laser radiation tissue interaction. *Health Phys.* 56: 613-616
- Holme S.A., Anstey A.V., Finlay A.Y., Elder G.H. and Badminton M.N. (2006). Erythropoietic protoporphyria in the U.K.: clinical features and effect on quality of life. *Br J Dermatol.* 155:574-81.
- Holme S.A., Malinovsky K. and Roberts D.L. (2000). Changing trends in non-melanoma skin cancer in South Wales, 1988-98. *Br J Dermatol.* 143:1224-9.
- IARC (2010). Monograph Volume 98: painting, firefighting, and shiftwork. IARC Monographs on the Evaluation of Carcinogenic Risks to Humans.



Ide T., Kinugawa Y., Nobae Y., Suzuki T., Tanaka Y., Toda I., Tsubota K. (2015). LED Light Characteristics for Surgical Shadowless Lamps and Surgical Loupes. *Plast Reconstr Surg Glob Open*. 9;3(11): e562.

IEEE Recommended Practices for Modulating Current in High-Brightness LEDs for Mitigating Health Risks to Viewers, Std 1789-2015, Piscataway.

IEC/TR 62778:2014 Application of IEC 62471 for the assessment of blue light hazard to light sources and luminaires <https://webstore.iec.ch/publication/7427>

IES. Illuminating Engineering Society. (2011). *The Lighting Handbook*, Tenth Edition, ISBN 978-087995-241-9. New York.

International Commission on Non-Ionizing Radiation Protection. Guidelines on limits of exposure to incoherent visible and infrared radiation. *Health Phys.* 105 (2013) 74-96. [http://www.icnirp.org/cms/upload/publications/ICNIRPVisible\\_Infrared2013.pdf](http://www.icnirp.org/cms/upload/publications/ICNIRPVisible_Infrared2013.pdf).

ICNIRP. General approach to protection against non-ionizing radiation. (2002). *Health Phys.* 82:540-548.

Jacques S.L. (2013). Optical properties of biological tissues: a review, *Phys. Med. Biol.* 58 R37-R61

James R.H., Landry R.J., Walker B.N. and Ilev I.K. (2017). Evaluation of the potential optical radiation hazards with led lamps intended for home use. *Health Phys.* 112(1):11-17; 2017.

Johnson K., Guy A. (1972). Impact of non-ionizing electromagnetic radiation on biological systems and the environment. *Proc. IEEE.* 60(6), 49-79

Joo E.Y., Abbott S.M., Reid K.J., Wu D., Kang J., Wilson J., and Zee P.C. (2017). Timing of light exposure and activity in adults with delayed sleep-wake phase disorder. *Sleep Med.* 32:259-265

Karu T.I. (1987). Photobiological fundamentals of low-power laser therapy. *IEEE J Quantum Electron.* 23:1703-1717

Karu T.I. (2003). Low-power laser therapy. IN *Biomedical photonics handbook*. Editor Vo-Dinh T, Florida: CRC Press.

Kayaba M., Iwayama K., Ogata H., Seya Y., Kiyono K., Satoh M., and Tokuyama K. (2014). The effect of nocturnal blue light exposure from light-emitting diodes on wakefulness and energy metabolism the following morning. *Environ Health Prev Med.* 19(5): 354-361.

Kim J., Hwang Y., Kang S., Kim M., Kim T.S., Kim J., Seo J., Ahn H., Yoon S., Yun J.P., Lee Y.L., Ham H., Yu H.G., Park S.K. (2016). Association between Exposure to Smartphones and Ocular Health in Adolescents. *Ophthalmic epidemiology.* 23(4):269-76.

Klein B. E. K., Klein R. (2007). Lifestyle Exposures and Eye Diseases in Adults. *American Journal of Ophthalmology*, 144(6), 961-969. <http://doi.org/10.1016/j.ajo.2007.08.016>

Kleinman M.H., Smith M.D., Kurali E., Kleinpeter S., Jiang K., Zhang Y., Kennedy-Gabb S.A., Lynch A.M. and Geddes C.D. (2010). An evaluation of chemical photoreactivity and the relationship to phototoxicity. *Regul Toxicol Pharmacol.* 58:224-32.

Kohen E., Hirschberg J., Santus R. (1995). *Photobiology*. Academic Press. San Diego, CA, USA; London, UK.

Kozaki T., Kubokawa A., Taketomi R., and Hatae K. (2016). Light-induced melatonin suppression at night after exposure to different wavelength composition of morning light. *Neuroscience Letters* 616: 1-4.

Krigel A., Berdugo M., Picard E., Levy-Boukris R., Jaadane I., Jonet L., Dernigoghossian M., Andrieu-Soler C., Torriglia A., Behar-Cohen F. (2016). Light-induced retinal damage

using different light sources, protocols and rat strains reveals LED phototoxicity. *Neuroscience*. 339:296-307

Kumar Khanna V. (2014). *Fundamentals of solid-state lighting - LEDs, OLEDs, and their applications in illumination and displays*. CRC Press (Taylor & Francis Group), Boca Raton (FL).

Kuse Y., Ogawa K., Tsuruma K., Shimazawa M., and Hara H. (2014). Damage of photoreceptor-derived cells in culture induced by light emitting diode-derived blue light, *Sci Rep*. 4: 5223.

Kvam E. and Tyrrell R.M. (1997). Induction of oxidative DNA base damage in human skin cells by UV and near visible radiation. *Carcinogenesis*. 18(12):2379-84.

Lau L.I., Chiou S.H., Liu C.J., Yen M.Y., Wei Y.H. (2011). The effect of photo-oxidative stress and inflammatory cytokine on complement factor H expression in retinal pigment epithelial cells. *Invest. Ophthalmol. Vis. Sci*. 52, 6832e6841.

Leccese F., Vandelanotte V., Salvadori G. and Rocca M. (2015). *Sustainability*, 7, 13454-13468; doi:10.3390/su71013454

Lee H.S., Cui L., Li Y., Choi J.S., Choi J-H, Li Z., Kim G.E., Choi W., Yoon K.C. (2016) Influence of Light Emitting Diode-Derived Blue Light Overexposure on Mouse Ocular Surface. *PLoS ONE* 11(8): e0161041. doi:10.1371/journal.

Lehmann A.R. (1995). The molecular biology of nucleotide excision repair and double-strand break repair in eukaryotes. *Genet. Eng. (N Y)* 17:1-19

Lim S.R., Kang D., Ogunseitan O.A., Schoenung J.M. (2011). Potential environmental impacts of light-emitting diodes (LEDs): metallic resources, toxicity, and hazardous waste classification. *Environ Sci Technol*. 45(1):320-7

Lister P., Wright T.A., Chappell P.H. (2012). Optical properties of human skin. *J Biomed Optics*. 17: 090901-1-15.

Litvack F., Grundfest W.S., Papaioannou T., Mohr F.W., Jakubowski A.T. and Forrester J.S. (1988). Role of laser and thermal ablation devices in the treatment of vascular diseases. *Am. J. Cardiol*. 61: 81-86.

Liu H. (2012). Caractérisation de tissus cutanés cicatriciels hypertrophiques par spectroscopie multi-modalités *in vivo* : instrumentation, extraction et classification de données multi-dimensionnelles. PhD Thesis. Université de Lorraine (in French).

Liu P.T., Stenger S., Li H., Wenzel L., Tan B.H., Krutzik S.R., Ochoa M.T., Schaubert J., Wu K., Meinken C., Kamen D.L., Wagner M., Bals R., Steinmeyer A., Zügel U., Gallo R.L., Eisenberg D., Hewison M., Hollis B.W., Adams J.S., Bloom B.R. and Modlin R.L. (2006). Toll-like receptor triggering of a vitamin D mediated human antimicrobial response. *Science*. 311:1770-3.

Lu C.C., Chou C., Yasukouchi A., Kozaki T. and Liu C.Y. (2016). Effects of nighttime lights by LED and fluorescent lighting on human melatonin. *Journal of Ambient Intelligence and Humanized Computing* 7(6): 837-844.

Lucas R.J., Peirson S.N., Berson D.M., Brown T.M., Cooper H.M., Czeisler C.A., Figueiro M., Gamlin P.D., Lockley S.W., O'Hagan J.B., Price L.L., Provencio I., Skene D.J. and Brainard G.C. (2014). Measuring and using light in the melanopsin age. *Trends Neurosci*. 37(1): 1-9.

MacFarlane D.F., Alonso C.A. (2009). Occurrence of nonmelanoma skin cancers on the hands after UV nail light exposure. *Arch Dermatol*. 145:447-449.

Magee M., Marbas E.M., Wright K.P. Jr., Rajaratnam S.M., and Broussard J.L. (2016). Diagnosis, Cause, and Treatment Approaches for Delayed Sleep-Wake Phase Disorder. *Sleep Med Clin* 11(3): 389-401.

- Markova A., Weinstock M.A. (2013). Risk of Skin Cancer Associated with the Use of UV Nail Lamp. *J Invest Dermatol.* 133 :1097–1099.
- Martásek P. (1998). Hereditary coproporphyrinuria. *Semin Liver Dis.* 18:25-32.
- Mattis J. and Sehgal A. (2016). Circadian Rhythms, Sleep, and Disorders of Aging. *Trends in Endocrinology & Metabolism* 27(4): 192-203.
- Miyauchi M. and Nakajima H. (2016). Determining an Effective UV Radiation Exposure Time for Vitamin D Synthesis in the Skin Without Risk to Health: Simplified Estimations from UV Observations. *Photochemistry and Photobiology.* 92: 863–869.
- Monajembashi S., Cremer C., Cremer T., Wolfrum J. and Greulich K.O. (1986). Microdissection of human chromosomes by a laser microbeam. *Exp. Cell. Res.* 167: 262-265.
- Montaudié H., Lacour J.P., Rostain G., Duteil L., Passeron T. (2014). Solar urticaria to visible light triggered by light-emitting diode therapy. *J Am Acad Dermatol.* 71(3):e74-5.
- Morita D., Nishida Y., Higuchi Y., Seki T., Ikuta K., Asano H., and Ishiguro N. (2016). Short-range ultraviolet irradiation with LED device effectively increases serum levels of 25(OH)D. *Journal of Photochemistry & Photobiology, B: Biology.* 164, 256–263.
- Mykletun M., Aarsand A.K., Støle E., Villanger J.H., Tollånes M.C., Baravelli C., Sandberg S. (2014). Porphyrias in Norway. *Tidsskr Nor Laegeforen.* 134:831-6. [Article in English, Norwegian]
- Nakashima Y., Ohta S. and Wolf M. A. (2017): Blue light-induced oxidative stress in live skin, *Free Radical Biology and Medicine*,  
<http://dx.doi.org/10.1016/j.freeradbiomed.2017.03.010>
- Narimatsu T., Ozawa Y., Miyake S., Kubota S., Hirasawa M., Nagai N., Shimmura S., Tsubota K. (2013). Disruption of cell-cell junctions and induction of pathological cytokines in the retinal pigment epithelium of light-exposed mice. *Invest. Ophthalmol. Vis. Sci.* 54, 4555e4562
- Nouri K. (2011). *Lasers in dermatology and medicine*, Springer Ed., London, Dordrecht, Heidelberg, New York
- O'Hagan J.B., Khazova M. and Price L.L.A. (2016). Low energy light bulbs, computers, tablets and the blue light hazard. *Eye*, 30, 230-233.
- Orphanet. The portal for rare diseases and orphan drugs  
<http://www.orpha.net/> (accessed 20 June, 2017)
- Orphanet Report Series - Prevalence of rare diseases: Bibliographic data - November 2016 - Number 1.  
[http://www.orpha.net/orphacom/cahiers/docs/GB/Prevalence\\_of\\_rare\\_diseases\\_by\\_alphabetical\\_list.pdf](http://www.orpha.net/orphacom/cahiers/docs/GB/Prevalence_of_rare_diseases_by_alphabetical_list.pdf) (accessed 20 June, 2017)
- Panda S., Nayak S.K., Campo B., Walker J.R., Hogenesch J.B. and Jegla T. (2005). Illumination of the Melanopsin Signaling Pathway. *Science* 307(5709): 600-604.
- Parsons M.J., Moffitt T.E., Gregory A.M., Goldman-Mellor S., Nolan P.M., Poulton R., and Caspi A. (2015). Social jetlag, obesity and metabolic disorder: investigation in a cohort study. *Int J Obes (Lond)* 39(5): 842-848.
- Pattison D.I., Rahmanto A.S., Davies M.J. (2012). Photo-oxidation of proteins, *Photochem. Photobiol. Sci.* 11 pp. 38–53
- Patton D.F. and Mistlberger R.E. (2013). Circadian adaptations to meal timing: neuroendocrine mechanisms. *Front Neurosci.* 7: 185.
- Provencio I., Jiang G., De Grip W.J., Hayes W.P., Rollag M.D.. Melanopsin: An opsin in melanophores, brain, and eye. *Proceedings of the National Academy of Sciences of the United States of America.* 1998;95(1):340-345.

- Quirk J.A., Fish D.R., Smith S.J.M., Sanders J.W.A.S., Shorvon S.D., and Allen P.J. (1995). First seizures associated with playing electronic screen games: A community-based study in Great Britain. *Annals of Neurology*. 37, 6, 733-737.F
- Rambhatla P.V., Brescoll J., Hwang F., Juzych M. and Lim H.W. (2015). Photosensitive disorders of the skin with ocular involvement. *Clin Dermatol*. 33:238-46.
- Rangtell F.H., Ekstrand E., Rapp L., Lagermalm A., Liethof L., Bucaro M.O., Lingfors D., Broman J.E., Schiöth H.B. and Benedict C. (2016). Two hours of evening reading on a self-luminous tablet vs. reading a physical book does not alter sleep after daytime bright light exposure. *Sleep Med* 23: 111-118.
- Rea M.S., Figueiro M.G., Bullough J.D., Bierman A. (2005). A model of phototransduction by the human circadian system. *Brain Research Reviews* 2005; 50:213–228
- Rhodes L.E., Bock M., Janssens A.S., Ling T.C., Anastasopoulou L., Antoniou C., Aubin F., Bruckner T., Faivre B., Gibbs N.K., Jansen C., Pavel S., Stratigos A.J., de Gruijl F.R. and Diepgen T.L. (2010). Polymorphic light eruption occurs in 18% of Europeans and does not show higher prevalence with increasing latitude: multicenter survey of 6,895 individuals residing from the Mediterranean to Scandinavia. *J Invest Dermatol*.130:626-8.
- Rimington C. (1985). A review of the enzymic errors in the various porphyrias. *Scand J Clin Lab Invest*. 45:291-301.
- Roberts J.E. and Wilkins A.J. (2013). Flicker can be perceived during saccades at frequencies in excess of 1 kHz. *Lighting Research and Technology*, 45, 124-132.
- Roberts J.E., Finley E.L., Patat S.A., Schey K.L. (2001). Photooxidation of lens proteins with xanthurenic acid: a putative chromophore for cataractogenesis, *Photochem. Photobiol*. 74 (5) pp. 740–744
- Roberts J.E. (2002). Screening for Ocular Phototoxicity. *International Journal of Toxicology*, 21:491–500
- Rochette P.J., Therrien J-P, Drouin R., Perdiz D., Bastien N., Drobetsk E.A., Sage E. (2003). UVA-induced cyclobutane pyrimidine dimers form predominantly at thymine-thymine dipyrimidines and correlate with the mutation spectrum in rodent cells. *Nucleic Acids Res*. 31(11): 2786–2794
- Roehlecke C., Schumann U., Ader M., Knels L., Funk RHW. (2011). Influence of blue light on photoreceptors in a live retinal explant system. *Mol Vis*.17: 876–84
- Roehlecke C., Schaller A., Knels L., and Funk R.H. (2009) The influence of sublethal blue light exposure on human RPE cells. *Mol.Vis*. 15, 1929–1938
- Roenneberg T., Kuehnle T., Juda M., Kantermann T., Allebrandt K., Gordijn M. and Meroow M. (2007). Epidemiology of the human circadian clock. *Sleep Med Rev*. 11(6): 429-438.
- Rossmann-Ringdahl I., Olsson R. (2005). Porphyria cutanea tarda in a Swedish population: risk factors and complications. *Acta Derm Venereol*. 85:337-41.
- Rosenfield M. (2011). Computer vision syndrome: a review of ocular causes and potential treatments. *Ophthalmic & physiological optics: the journal of the British College of Ophthalmic Opticians*. 31(5):502-15.
- Rozanowska M., Jarvis-Evans J., Korytowski W., Boulton M.E., Burke J.M., Sarna T. (1995). Blue light-induced reactivity of retinal age pigment - *in vitro* generation of oxygen-reactive species. *J BiolChem* 270:18825-18830.
- Sandell J.L. and Zhu T.C. (2011). A review of in-vivo optical properties of human tissues and its impact on PDT *J. Biophotonics*. 4 773–87 Bashkatov A N.

- Sassa S. (2006). Modern diagnosis and management of the porphyrias. *Br J Haematol.* 135:281-92.
- SCENIHR (Scientific Committee on Emerging and Newly Identified Health Risks), Health effects of artificial light, March 19, 2012
- SCENIHR (Scientific Committee on Emerging and Newly Identified Health Risks), Scientific Opinion on The safety of dental amalgam and alternative dental restoration materials for patients and users. 29 April 2015.
- SCHIEER (Scientific Committee on Health, Environmental and Emerging Risks), Opinion on Biological effects of ultraviolet radiation relevant to health with particular reference to sunbeds for cosmetic purposes, 17 November 2016.
- Schomerus C. and Korf H.W. (2005). Mechanisms regulating melatonin synthesis in the mammalian pineal organ. *Ann N Y Acad Sci.* 1057: 372-383.
- Serezhnikova N.B., Pogodinab L.S., Lipinab T.V., Trofimovaa N.N., Gurievac T.S. and Zaka P.P. (2017). Age-Related Adaptive Responses of Mitochondria of the Retinal Pigment Epithelium to the Everyday Blue LED Lighting. *Doklady Biological Sciences*, 475: 141–143.
- Shang Y.M., Wang G.S., Sliney D., Yang C.H., Lee L.L. (2014). White light-emitting diodes (LEDs) at domestic lighting levels and retinal injury in a rat model. *Environ Health Perspect.* 122;269–276
- Shang Y.M., Wang G.S., Sliney D., Yang C.H., Lee L.L. (2017). Light-emitting-diode induced retinal damage and its wavelength dependency *in vivo*. *Int J Ophthalmol.* 10(2): 191–202.
- Shipp L.R., Warner C.A., Ruedgeberg F.A., Davis L.S. (2014). Further investigation into the risk of skin cancer associated with the use of UV nail lamps. *JAMA Dermatology* 150:775-776.
- Sliney D.H. (2001). Photoprotection of the eye - UV radiation and sunglasses. *J. 17 - Photochem. Photobiol. B* 64, 166e175.
- Sliney D.H. (2002). How light reaches the eye and its components. *Int. J. Toxicol.* 21, 501e509.
- Sliney D.H. (2006). Risks of occupational exposure to optical radiation. *Med Lav.* 97: 215–20
- Schwarz T. (2008). 25 years of UV-induced Immunosuppression Mediated by T Cells—From Disregarded T Suppressor Cells to Highly Respected Regulatory T Cells. *Photochemistry and Photobiology*, 84: 10-18. doi:[10.1111/j.1751-1097.2007.00223.x](https://doi.org/10.1111/j.1751-1097.2007.00223.x)
- Sui G.Y., Liu G.C., Liu G.Y., Gao Y.Y., Deng Y., Wang W.Y., Tong S.H., Wang L. (2013). Is sunlight exposure a risk factor for age-related macular degeneration? A systematic review and meta-analysis. *Br. J. Ophthalmol.* 97, 389e394.
- Takahashi J.S. (2017). Transcriptional architecture of the mammalian circadian clock. *Nat Rev Genet.* 2017 Mar;18(3):164-179
- Tiao J. and Werth V.P. (2015). Cutaneous lupus erythematosus flare following exposure to surgical light during a dental procedure. *BMJ Case Rep* Published online: 9 December 2015 doi:10.1136/bcr-2015-212864 (accessed 20 June 2017).
- Torii M, Kojima D, Okano T, Nakamura A, Terakita A, Shichida Y, Wada A and Fukada Y (2007). Two isoforms of chicken melanopsins show blue light sensitivity. *FEBS Lett.*
- Tosini G, Ferguson I and Tsubota K (2016). Effects of blue light on the circadian system and eye physiology. *Mol Vis.* 22: 61-72.
- Turro NJ. (1991). Modern molecular photochemistry, University Science Books: Sausalito, CA, USA.

- Utz SR, Barth J, Knuschke P, Sinichkin YuP (1993). Fluorescence spectroscopy of human skin. *Proc. SPIE*. 2081, 48–57.
- Valbuena MC, Muvdi S and Lim HW (2014). Actinic prurigo. *Dermatol Clin*. 32:335-44.
- Versteeg RI, Stenvers DJ, Kalsbeek A, Bisschop PH, Serlie MJ and la Fleur SE (2016). Nutrition in the spotlight: metabolic effects of environmental light. *Proc Nutr Soc*. 75(4): 451-463.
- Wang XS, Armstrong ME, Cairns BJ, Key TJ and Travis RC (2011). Shift work and chronic disease: the epidemiological evidence. *Occup Med (Lond)* 61(2): 78-89.
- West KE, Jablonski MR, Warfield B, Cecil KS, James M, Ayers MA, Maida J, Bowen C, Sliney DH, Rollag MD, Hanifin JP and Brainard G.C. (2011). Blue light from light-emitting diodes elicits a dose-dependent suppression of melatonin in humans. *Journal of applied physiology* (Bethesda, Md.: 1985) 110(3): 619-626.
- WHO. (1994). Assessing human health risks of chemicals: derivation of guidance values for health-based exposure limits, *Environmental Health Criteria*, WHO (World Health Organisation), <http://www.inchem.org/documents/ehc/ehc/ehc170.htm>.
- Wilkins A.J., Bonanni P., Porciatti P., and Guerrini R. (2004). Physiology of Human Photosensitivity. *Epilepsia*, 45(Suppl. 1):7–13.
- Wittmann M., Dinich J., Mellow M., and Roenneberg T. (2006). Social jetlag: misalignment of biological and social time. *Chronobiol Int*. 23(1-2): 497-509.
- Wong PM, Hasler BP, Kamarck TW, Muldoon MF and Manuck S.B. (2015). Social Jetlag, Chronotype, and Cardiometabolic Risk. *J Clin Endocrinol Metab*. 100(12): 4612-4620.
- Wood B, Rea MS, Plitnick B, and Figueiro M.G. (2013). Light level and duration of exposure determine the impact of self-luminous tablets on melatonin suppression. *Appl Ergon*. 44(2): 237-240.
- Wright HR, Lack LC and Kennaway DJ (2004). Differential effects of light wavelength in phase advancing the melatonin rhythm. *J Pineal Res*. 36(2): 140-144.
- Wright HR, Lack LC and Partridge KJ (2001). Light emitting diodes can be used to phase delay the melatonin rhythm. 31: 350-355.
- Wu J, Uchino M, Sastry SM, Schaumberg DA (2014). Age-related macular degeneration and the incidence of cardiovascular disease: a systematic review and meta-analysis. *PLoS One* 9, e89600.
- Xie C, Li X, Tong J, Gu Y Shen Y (2014) Effects of white light-emitting diode (LED) light exposure with different correlated color temperatures (CCTs) on human lens epithelial cells in culture. *Photochem Photobiol*. 90(4):853-9. PDF NOT IN MY FILE)
- Yu DY, Cringle SJ (2005). Retinal degeneration and local oxygen metabolism. *Exp Eye Res*. 80(6):745-51.
- Zastrow L, Groth N, Klein F, Kockott D, Lademann J, Renneberg R, Ferrero L (2009). The Missing Link – Light-Induced (280–1,600 nm) Free Radical Formation in Human Skin. *Skin Pharmacol Physiol*. 22:31-44

## 10. GLOSSARY OF TERMS

This Glossary is provided as an aid to understanding some of the terms used in this Opinion.

<b>Absorption</b>	Absorption: Process by which radiant energy is converted to a different form of energy by interaction With matter ( <a href="http://eilv.cie.co.at/">http://eilv.cie.co.at/</a> ).
<b>Exposure limits</b>	The exposure limits were derived on the basis of current knowledge on damage thresholds and in accordance with the ICNIRP principles (ICNIRP 2002). The exposure limits are set to a level below the damage thresholds by applying a reduction factor. In view of uncertainties inherent in the damage thresholds, a reduction factor of at least two has been applied in deriving the exposure limits (ICNIRP 2013).
<b>Action spectrum</b>	the rate of a physiological activity plotted against wavelength of light. It shows which wavelength of optical radiation is most effectively used in a specific chemical reaction. Action spectra are a necessary basis for finding the pigment(s) responsible or a specific photoresponse
<b>Adverse effects</b>	WHO definition for "adverse effect": An effect is considered "adverse" when leading to a change in the morphology, physiology, growth, development, reproduction or life span of an organism, system or (sub)population that results in an impairment of functional capacity to compensate for additional stress or an increase in susceptibility to other influences" (WHO, 2009)
<b>Blue light hazard (BLH)</b>	the potential for a photochemical-induced retinal injury resulting from electromagnetic radiation exposure at wavelengths primarily between 400 and 500 nm. The BLH mechanism overrules the thermal damage for long exposure times (more than 10 sec).
<b>Blue light hazard irradiance</b>	irradiance, spectrally weighted with the blue hazard ( $W/m^2$ )
<b>Candela</b>	The luminous intensity, in a given direction, of a source that emits monochromatic radiation of frequency $540 \times 10^{12}$ hertz and that has a radiant intensity in that direction of $1/683$ watt per steradian. The definition describes how to produce a light source that (by definition) emits one candela.

<b>Chronotype</b>	An indication of a person's preference for the morning or evening of the day.
<b>Correlated Colour Temperature</b>	a specification of the colour appearance of the light emitted by a lamp, relating its colour to the colour of light from a reference source when heated to a particular temperature, measured in degrees Kelvin (K)
<b>Degree of erythema</b>	The minimal erythemal dose (MED), which is defined as the threshold UV dose for a minimal redening of the skin occurring a few hours after exposure, is typically 200-250 J/m <sup>2</sup> for phototype II after weighting with the CIE action spectrum for erythema. A standard erythemal dose (SED) is defined as 100 J/m <sup>2</sup> CIE erythemally-weighted UV.
<b>Dose-response relationship</b>	The dose-response relationship, or exposure-response relationship, describes the change in effect on an organism caused by differing levels of exposure (or doses) to a stressor after a certain exposure time
<b>Electroluminescence</b>	Optical phenomenon and electrical phenomenon in which a material emits light when an electric current pass through it
<b>Electromers</b>	one of two or more substances that differ only in the distribution of electrons
<b>External quantum efficiency</b>	is the quotient of the number of photons emitted out of the LED over the number of electrons passed in the device.
<b>Feeding efficiency</b>	is the quotient of the average ratio of photons emitted to the total energy acquired by an electron-hole pair from the power supply when the LED is operating.
<b>Fluorescence</b>	Emission of optical radiation, usually visible light, caused by excitation of atoms in a material, which then reemit almost immediately (in approx. 10 <sup>-8</sup> seconds)
<b>Forward currents</b>	The current which flows across the LED's leads, from anode to cathode, in order for the LED to receive sufficient current to power on
<b>Forward voltage</b>	The forward voltage is the voltage drop across the diode if the voltage at the anode is more positive than the voltage at the cathode



<b>Forward voltage drop</b>	Is the voltage drop across a conducting, forward-biased, LED. It depends on the energy bandgap of the semiconductor material from which the diode is made as well as the series resistance of the material. LEDs are made to produce a variety of colours, using different materials and energy bandgaps. As an example, the forward voltage drop of red LEDs is around 2.2 V and the forward voltage drop for white/blue LEDs is in the range of 3.1 to 3.8 V [Kumar Khanna, 2014].
<b>Glare</b>	difficulty seeing in the presence of bright light such as direct or reflected sunlight or artificial light such as car headlamps at night.
general population	The definitions are dependent on the purpose - for the purpose case, SCHEER considers that the general population means "all individuals without reference to any specific characteristics"
<b>High-brightness LED</b>	Any of a new generation of LEDs bright enough for illumination applications such as automotive interior, exterior, and display
<b>Illuminance</b>	irradiance, spectrally weighted with the photopic eye sensitivity curve. The SI derived unit is lux.
<b>Irradiance (exposure rate)</b>	radiant energy per surface area per unit time in ( $\text{J}/\text{m}^2\text{s} = \text{W}/\text{m}^2$ ).
<b>Lumen</b>	The standard unit for the luminous flux of a light source. It is an SI derived unit based on the candela. It can be defined as the luminous flux emitted into unit solid angle (1 sr) by an isotropic point source having a luminous intensity of 1 candela.
<b>Luminance</b>	A photometric measure of the luminous intensity per unit area of light travelling in a given direction. It describes the amount of light that passes through, is emitted or reflected from a particular area, and falls within a given solid angle. The SI derived unit for luminance is candela per square metre ( $\text{cd}/\text{m}^2$ )
<b>Luminous efficacy</b>	Is the quotient of the luminous flux emitted by the electrical power consumed by the LED; it is measured in lumens/watt.
<b>Luminous flux</b>	The quantity of the energy of the light emitted per second in all directions. The unit of luminous flux is lumen (lm).

<b>Luminous intensity</b>	A measure of the wavelength-weighted power emitted by a light source in a particular direction per unit solid angle, based on the luminosity function, a standardized model of the sensitivity of the human eye. The SI unit of luminous intensity is the candela (cd)
<b>Phosphorescence</b>	The emission of light from a substance exposed to radiation which persists after the exciting radiation has been removed
<b>Radiance</b>	radiant intensity per area emitted from a source; in (W/m <sup>2</sup> sr)
<b>Radiant efficiency</b>	the product of external quantum efficiency and feeding efficiency.
<b>Radiant exposure</b>	radiant energy per surface area in J/m <sup>2</sup>
<b>Radiant intensity</b>	The radiant flux emitted, reflected, transmitted or received, per unit solid angle, and spectral intensity is the radiant intensity per unit frequency or wavelength, depending on whether the spectrum is taken as a function of frequency or of wavelength.
<b>Radiant power</b>	Radiant power or <b>radiant flux</b> in radiometry is the radiant energy emitted, reflected, transmitted or received, per unit time, and spectral flux or spectral power is the radiant flux per unit frequency or wavelength, depending on whether the spectrum is taken as a function of frequency or of wavelength.
<b>Reduction factor</b>	Thresholds for damage following a target's exposure to optical radiation are determined experimentally. A reduction factor is applied to the threshold data, which takes into account the uncertainty in the threshold data. ICNIRP applies reduction factors of at least 2.
<b>Reflectance</b>	Reflectance = regular + diffuse reflectance Regular reflectance: = ratio of the regularly (specular) reflected part of the (whole) reflected flux to the incident flux ( <a href="http://eilv.cie.co.at/">http://eilv.cie.co.at/</a> ).
<b>Regular reflectance</b>	The radiation that penetrates the skin and is scattered back later
<b>Remission (diffusion reflectance)</b>	The fraction of incident radiation that returns from the skin or from a particular sample
<b>Singlet oxygen</b>	The most energetic state of oxygen generated by light excitation of the ground state of oxygen

<b>Steradian</b>	The unit for a solid angle, which is the 3 dimensional analogue of an ordinary angle. Any area on a sphere, which is equal in area to the square of its radius, when observed from its centre, subtends precisely one steradian (sr)
<b>Temporal light artefact</b>	Change in visual perception, induced by a light stimulus, the luminance or spectral distribution of which, fluctuates with time, for a human observer in a specified environment
<b>Temporal light modulation</b>	Variation in emission of light as a function of time, which can give rise to a number of different temporal light artefacts. In some contexts, the term "flicker" is also used to describe temporal modulation of the light itself, whether the light modulation produces visual effects or not.
<b>Transmission</b>	The passage of electromagnetic radiation through a medium
<b>Zeitgeber</b>	A rhythmically occurring natural phenomenon, such as light, which acts as a cue in the regulation of the body's circadian rhythms.

## 11. LIST OF ABBREVIATIONS

<b>AC</b>	Alternating current
<b>AD</b>	Atopic dermatitis
<b>AK</b>	Actinic keratosis
<b>AMD</b>	Age-related macular degeneration
<b>ARM</b>	Age-related maculopathy
<b>BCC</b>	Basal cell carcinoma
<b>CAD</b>	Chronic actinic dermatitis
<b>CCFL</b>	Cold-cathode fluorescent lamp
<b>CFL</b>	Compact fluorescent lamp
<b>CI</b>	Confidence interval
<b>CIE</b>	Commission International de l'Éclairage
<b>CMM</b>	Cutaneous malignant melanoma
<b>CRI</b>	Colour rendering index
<b>DC</b>	Direct current
<b>DNA</b>	Deoxyribonucleic acid
<b>ECDC</b>	European Centre for Disease prevention and control
<b>ECHA</b>	European Chemicals Agency
<b>EEH</b>	Energy-efficient halogen lamp
<b>EFSA</b>	European Food Safety Authority

<b>ELC</b>	European Lamp Companies Federation
<b>ELV</b>	Exposure limit value
<b>EM</b>	Electromagnetic (radiation)
<b>EN</b>	European standards
<b>EU</b>	European Union
<b>FL</b>	Fluorescent lamps
<b>GaAs</b>	Gallium arsenide
<b>GLS</b>	General Lighting System
<b>HID</b>	High-intensity discharge lamp
<b>ICNIRP</b>	International Commission on Non-Ionizing Radiation Protection
<b>ipRGCs</b>	Intrinsically photosensitive retinal ganglion cells
<b>IR</b>	Infrared (radiation)
<b>IR-A</b>	The wavelength range of 780-1400 nm
<b>LE</b>	Lupus erythematosus
<b>LED</b>	Light emitting diode
<b>LET</b>	Lupus erythematosus tumidus
<b>LPS</b>	Sodium low-pressure lamp
<b>LVD</b>	Low Voltage Directive
<b>LWS</b>	Long wavelength cone opsin, Long wavelength sensitive cones (red)
<b>MED</b>	Minimal erythemal dose

<b>MHL</b>	Metal halide lamp
<b>MWS</b>	Medium wavelength cone opsin, medium wavelength sensitive cones (green)
<b>NIR LED</b>	Near Infra Red LED of wavelengths between 780 nm and 1400 nm
<b>OLED</b>	Organic light emitting diodes
<b>OR</b>	Odds Ratio
<b>PDT</b>	Photodynamic therapy
<b>PLE</b>	Polymorphic light eruption
<b>PMLE</b>	Polymorphous light eruption
<b>POLA</b>	Pathologies Oculaires Liées à l'Age (study)
<b>PWM</b>	Pulse width modulation
<b>ROS</b>	Reactive oxygen species
<b>RPE</b>	Retinal pigment epithelial cells
<b>RR</b>	Relative risk
<b>SAD</b>	Seasonal affective disorder
<b>SCC</b>	Squamous cell carcinoma
<b>SCCS</b>	Scientific Committee on Consumer Safety
<b>SCENIHR</b>	Scientific Committee on Emerging and Newly Identified Health Risks
<b>SCHER</b>	Scientific Committee on Health and Environmental Risks
<b>SCN</b>	Suprachiasmatic nucleus
<b>SED</b>	Standard erythemal dose

<b>SHP</b>	Sodium high-pressure discharge lamp
<b>SI</b>	Système International d'unités (International System of Units)
<b>SLE</b>	Systemic lupus erythematosus
<b>SSL</b>	Solid state lighting
<b>SWS</b>	Short wavelength cone opsin, short wave length sensitive cones (blue)
<b>TL</b>	Tube luminescent (French for luminescent tube)
<b>TLA</b>	Temporal light artefact
<b>TLM</b>	Temporal light modulation
<b>UV</b>	Ultraviolet (radiation)
<b>UV-A</b>	The wavelength range of 315-400 nm
<b>UV-B</b>	The wavelength range of 280-315 nm
<b>UV-C</b>	The wavelength range of 100-280 nm
<b>XP</b>	Xeroderma pigmentosum

## ANNEX I LED Technologies

### Inorganic LEDs

The first LEDs in the 1960s were based on gallium arsenide (GaAs) crystals and emitted infrared radiation but no visible radiation, therefore, their applicability was limited. The introduction of phosphorus (P) in GaAs resulted in a red-light LED. Some of the most common semiconductor materials used for LEDs are listed in Table 2.

**Table 2. Semiconductor materials used in LEDs and their resulting radiation (Gilbert, 2009)**

Material	Radiation emission
Aluminium gallium arsenide (AlGaAs)	Red and infrared
Aluminium gallium phosphide (AlGaP)	Green
Aluminium gallium indium phosphide (AlGaInP)	Bright orange red, orange, yellow
Aluminium gallium nitrate (AlGaN)	Near to far ultraviolet
Diamond (C)	Ultraviolet
Gallium arsenide phosphide (GaAsP)	Red, orange and red, orange, yellow
Gallium phosphide (GaP)	Red, yellow, green
Gallium nitrate (GaN)	Green, emerald green
Indium gallium nitrate (InGaN)	Bluish green, blue, near ultraviolet
Sapphire (Al <sub>2</sub> O <sub>3</sub> ) as substrate	Blue
Silicon carbide (SiC)	Blue

There are many variations of the basic technology that can enhance the efficiency of LEDs. The technology described above is based on a metallurgical interface formed between p- and n-doped semiconductors of the same material (homojunction). This can be replaced by materials of different energy bandgaps and/or polarity (heterojunction), so that the vast majority of photons produced are not reabsorbed in the LED materials and diffusion of electrons through the (shallow) p-region does not lead to non-radiative recombination at the interface.

### Organic LEDs

Organic LEDs (OLEDs) constitute the evolution of inorganic LEDs. Their name originates from the use of organic semiconductors to achieve light emission. Organic semiconductors are organic compounds containing sequences of carbon (C) and hydrogen (H) atoms, with occasionally nitrogen (N), oxygen (O), sulphur (S), or other atoms fastened to this sequence. In a saturated organic material there is an electron pair responsible for holding the carbon atoms together. Therefore, all electrons are bound to atoms and the material is an electrical insulator. However, in an unsaturated



organic material, excess electrons can exist in the carbon atom bonds, which are loosely bound to the carbon atoms. These electrons are called n-electrons and give the material the properties of a semiconductor by hopping, tunnelling and other charge mobility mechanisms. Organic semiconductors are considered an environmentally friendly technology and are biodegradable (Kumar Khanna, 2014).

Two types of electroluminescent materials are used for creating white OLEDs, namely, fluorescent and phosphorescent materials. Fluorescence is the emission of optical radiation (light) when a substance is exposed to any type of electromagnetic radiation, where the emitted radiation generally appears within 10 ns after the excitation. This effect is due to an allowed transition generally from an excited singlet state to a ground singlet state. Phosphorescence is any delayed emission of optical radiation which appears 10 ns or longer after the excitation. This term should be used only for the delayed emission due to a forbidden transition from an excited triplet state to a ground singlet state.

The first OLEDs were fabricated by the deposition of small organic molecules on substrates. However, this technology poses a number of difficulties including the fact that it has to be implemented in vacuum. As a result, polymeric LEDs were developed and proposed as an alternative, even though they have a less efficient performance and a shorter lifespan compared to small-molecule OLEDs.

Some basic performance characteristics which can be used for comparing LEDs of the same or different technologies are listed below:

### Comparison of different LEDs

Table 3 contains a comparison between inorganic and organic LEDs.

**Table 3. Comparison between inorganic and organic LEDs (Kumar Khanna, 2014)**

Characteristic	Inorganic LEDs	Organic LEDs
Operating voltage	Low	High
External quantum efficiency	High	Low
Maximum luminance	$10^6$ - $10^7$ cd/m <sup>2</sup>	$10^2$ - $10^4$ cd/m <sup>2</sup>
Glare effects	Possible	No (diffused light)
Lifetime	Long	Shorter (depends on environmental conditions)
Fabrication process	Complex	Simple

### White light

White light is composed of several colours as seen in the rainbow. It is also possible to create white light by additive colour mixing. This method is based on the physiological response of the human eye, which usually is expressed by saying that human vision is trichromatic. The three additive colours (also called primary) that are used for creating other visible colours by mixing them in appropriate proportions are red, green, and blue (RGB). In this way, it is possible to create white light by using three LEDs emitting in the

three primary additive wavelengths (colours). Nevertheless, there is a way to create a white perception by the eye using only two colours, known as a complementary pair. One colour of a complementary pair incorporates the wavelengths of a part of the visible spectrum, while the other encompasses the remaining range of wavelengths. Examples of complementary pairs are blue and yellow, green and magenta, and red and cyan.

The idea of complimentary pairs can help generate white light with a single LED, by the technique of wavelength conversion. The LED emits in a relatively narrow wavelength band compared to incandescent lamps. Some of the light emitted is absorbed by a phosphorescent material and re-emitted in a wavelength band in the residual spectrum. (The wavelength of the emitted photon by the phosphorescent substance is of longer wavelength than the absorbed one, an effect known as the *Stokes shift*.) As a result the initial light from the LED and the converted (in terms of wavelength) light from the phosphorescent material can be combined to produce white light.

### **White inorganic LEDs**

There are no inorganic LEDs emitting white light, i.e., radiation of such a broadband spectrum. The two techniques described above are used for manufacturing "white LEDs". In the case of multichip LEDs, three or more LEDs, each emitting light in a narrow band (e.g., in red, green, blue) are used. If a single LED is used, then wavelength conversion has to take place. Some of the techniques employed to achieve this include: (i) Blue LED + yellow phosphor (= phosphorescent material); (ii) Blue LED + several phosphors; (iii) Blue LED + quantum dots (= nanocrystals 2-10 nm size containing cadmium or selenium atoms); (iv) UV LED + RGB phosphors.

Multichip LEDs have a higher efficiency compared with the single chip LEDs, since wavelength conversion is accompanied by energy loss in the phosphorescent material. However, since every LED requires its own power source to electronically adjust the light it emits, RGB multichip LEDs become expensive, as well as challenging in the design of the electronic circuits needed to drive them. Therefore, due to the lower cost and ease of fabrication the most frequent method implemented to create white light is a near-UV or blue LED (InGaN-GaN) combined with a yellow phosphor (YAG:Ce).

### **White OLEDs (WOLEDs)**

White organic LEDs use the same principles for synthesizing white light, as the ones described above. However, it is easier to fabricate a single LED with white electroluminescence with organic materials. The main approaches to obtain white light from organic/organometallic emitters are summarized in Fig. 12 (Farinola and Ragni, 2011). There are two general categories of methods as mentioned above: (a) combination of two or more individual emitters of different colours, or (b) a single material that simultaneously emits different wavelengths covering a broad part of the visible spectrum. If the first approach is used, the emitters can be confined either in a single layer or stacked in a multilayer fashion. In the second approach a single compound can be employed that emits light at different wavelengths from molecules and their excited states (e.g., excimers or electromers). It is also possible to produce white light from one single polymer that contains different emitting moieties connected in the same molecular entity. The latter method offers the potential for low cost and large area light emitting devices but it poses the challenge of careful molecular design and arrangement, as well as precise control of the moiety ratios.

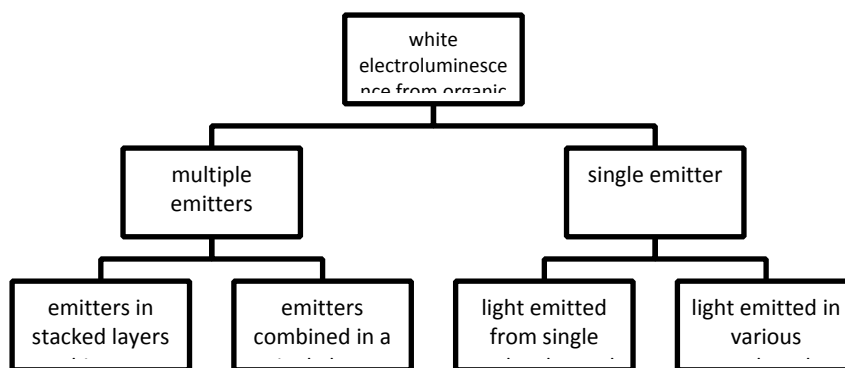

**Figure 12. Methods to produce white light with organic/organometallic emitters (adapted from Farinola and Ragni, 2011).**

### Thermal management of LEDs

The physical processes that convert electrical energy to light result in the production of heat, which must be removed from the devices, because overheating reduces their lifetime. Moreover, changes in temperature affect the forward voltage of an LED and the wavelength of light emitted. For white light generation with additive colour mixing (RGB technique) such a change in wavelength can be detrimental, since stability is necessary to get the desired result. The efficient thermal management of light emitting diodes allows for higher forward currents and, thus, more light emitted by it.

Thermal management is performed using materials with high thermal conductivity that permit heat to diffuse away from the LED to a heat sink. The latter is usually a plate or other structure of large surface made of copper, from which heat is removed by natural or forced convection. The design of the heat sink depends on the power supplied to the LED, the number of LEDs put together, as well as environmental conditions, such as temperature and site of operation (e.g., open space or enclosure).

### High-brightness LEDs

A high-brightness LED is one which gives a luminance flux of more than 50 lm (Kumar Khanna, 2014). AN LED that consumes high power is not necessarily of high-brightness. The efficacy of a high-brightness LED is about 100 lm/W and the driving current is 350 – 1400 mA. Effective heat removal is crucial for high-brightness LEDs and this is usually achieved by a heat sink immediately next to the LED junction.

High-brightness LEDs are used for backlighting (e.g., phone LCDs), flashlights, general illumination, automotive daylight running/headlamps, signal lamps and medical devices.

### Driving circuits of LEDs

One of the concerns raised about LED lighting, has been temporal light modulation. LEDs can usually be operated from a DC source. However, for various reasons, products are manufactured that produce optical emissions with a degree of temporal modulation. The various options for drive circuits are described below.

#### DC Circuits

There are two methods for driving an LED with a DC source, namely a constant voltage source or a constant current source. The first method is more problematic to implement: forward voltage may differ among LED batches within a manufacturing tolerance. As a result, the current flowing in each LED, when they are aggregated in luminaires, becomes uneven. However, LEDs are non-linear devices, which means that forward current changes drastically with small changes in forward voltage. This implies that uneven forward currents lead to dissimilar optical outputs from the LEDs with

detrimental impact on the desired operation of the luminaire. Therefore, it is preferable to drive LEDs at a constant current.

There are mainly two techniques to achieve a constant current supply to LEDs, namely by using a resistor to limit the current flowing in the LED and by using a constant current source, like a DC-DC converter. Although current limiting resistors are an inexpensive solution to constant current sources, they suffer from important drawbacks. Resistors dissipate electrical energy and generate heat, which is wasted power that needs to be removed. Moreover, using a voltage source and a resistor will not prevent the LED from experiencing voltage supply variations as current changes and, consequently, light output variations. Nor will it protect an LED from getting damaged by high voltage. Constant current supply suggests LED connection "in series" in a luminaire, a configuration where failure of one LED leads to a failure of the whole series of LEDs. Connection of LEDs "in parallel", which is inevitable in several cases either for single LEDs or for chains of them, still poses the problem, as discussed above, of equalising the current flowing in them.

### **AC circuits**

DC driving of LEDs is an optimal approach for battery powered devices, like mobile phones. However, when it comes to luminaires that stretch several metres (e.g., around a building) DC drive can result in significant losses, as in the case of power distribution, requiring high voltages and additional current regulators. However, to run an LED directly from the AC supply will require the use of a transformer to reduce voltage and a rectifier to make it as constant with time as possible. The output of a full-wave rectifier converts the sinusoidal AC voltage of 50/60 Hz to a DC voltage pulsating at double the frequency. Due to the fast response of LEDs the small changes in the DC voltage are translated into flickering light. To solve this problem, a capacitor in parallel to the LED may be used.

One way for LEDs to operate connected directly to an AC supply is the "Christmas tree lights" approach, where the driving voltage equals the sum of all voltage drops across each LED, when several of them are connected in series. Using this approach, two strings of LEDs can be connected to the source, each one in reverse polarization. In this way, during the positive half-cycle of the AC voltage, current can flow through the LEDs of one string only, while during the negative half-cycle, current can flow through the LEDs of the other string. It is important to note that in this approach the (reverse) voltage applied to each LED of the non-emitting string should be low enough not to damage it.

### **Dimmers**

LED dimming can be achieved either in an analogue or in a digital fashion. In the former case the forward current through the LED is varied, and so is the optical output. However, in this method heat is generated constantly, which may result in an undesired temperature change. Digital dimming is implemented with PWM (pulse width modulation), in which the forward current flows through the LED in a periodic pulsating manner for a fraction (duty cycle) of the total time cycle duration (comprising both on- and off-time intervals). As a consequence, the average current, which is related to the optical output, is different from the peak current. The pulsation of the forward current has to be performed at a rate (frequency) large enough, so that it is not perceived by the human eye either as a direct flicker or through a stroboscopic effect.

## ANNEX II The interaction between light and matter

There are four basic interactions that can occur following absorption of optical radiation:

(a) **Photothermal:** partial conversion of light energy into heat motion via transitional, rotational and vibrational modes of movements of the target molecules. The effects are produced by the photoexcitation of tissue by the production of thermal energy (heat), accompanied by an increase of the temperature for the exposed tissue (Cicchi *et al.*, 2016). The most important and significant alterations are dependent on the temperature of the tissue after absorption of the optical radiation, as follows: at 37°C, no measurable effects are observed; for the next 5°C above this, the tissue is thermally affected due to conformational changes of molecules. Some bond destruction and membrane alterations occur at approximately 42-50°C, and at 60°C denaturation of proteins and collagen occurs leading to coagulation of tissue and necrosis of cells. At higher temperatures (>80°C), the cell membrane permeability is drastically increased.

(b) **Thermal relaxation:** is influenced by the thermal coefficient of the tissue, the properties of the surrounding tissue or fluids and the temperature differential between the irradiated and non-irradiated tissue (Litvack *et al.*, 1988). An example is the exposure to intense flashes of light shorter than ~20 µs (not likely from current LEDs); when the rise in temperature is at least 10°C above the physiological temperature, the thermal damage occurs, which leads to thermal denaturation of many proteins. Factors that influence thermal relaxation are summarized as follows: absorption characteristics of the target tissue; emission mode: continuous wave or pulsed emission; incident power; power density; beam movement relative to tissue site (for example, with a laser beam, rapid beam movement, number of pulses, duty ratio and time gap between pulses allowing cooling) and beam diameter, will reduce heat build-up and aid thermal relaxation); endogenous coolant: water content and vascularity of the tissue.

(c) **Photochemical interactions:** when the radiant energy causes atomic or/and molecular excitation. In the photochemical reactions, the molecule must absorb optical radiation and the radiation energy must match the energy difference between the ground and excited state. Photochemical effects occur as a result of direct excitation of electronic bonds by the optical radiation (Litvack *et al.*, 1988). At shorter wavelengths, tissue components become electronically excited, thus this (photo excitation) leads to rupture of molecular bonds and formation of molecular fragments. Photochemical reactions generally do not result in a significant rise in temperature, but they are involved either a change in the course of biochemical reaction due to the presence of an electromagnetic field or photodecomposition due to high energy photons that rupture molecular bonds (Das, 1991; Monajembashi *et al.*, 1986; Niemz, 2004).

(d) **Photomechanical and photoelectrical interactions:** non-thermal interactions produced by high energy, short pulsed laser light, including: photodisruption, photodisassociation, photoplasmolysis and photoacoustic interaction. Absorption of pulses of energy results in rapid expansion or generation of shock waves responsible for photo-disruption or photodissociation. The laser beam's energy is transformed into vibration or kinetic energy (Harris *et al.*, 1989). Such interactions are not likely from current LEDs.

In conclusion, the light absorption can result in the formation of an (electronically) excited state, which has different chemical properties to the ground state. The intensity and shape of absorption spectra are a result of the nature of excitation between ground and excited states. Various processes result in the deactivation of the excited state. The energy could be lost through fluorescence or phosphorescence (emission of radiation of longer wavelengths) or dissipated as heat.

## Photobiology

Photobiology is the study of the interaction of optical radiation with living organisms.

ICNIRP guidelines (ICNIRP, 2013) state that exposures to optical radiation can produce acute onset of observable biological responses. In general there is a lack of knowledge regarding the injury threshold for effects from long term chronic exposure. But, in contrast to the ICNIRP guidelines for electromagnetic fields with wavelengths greater than 1 mm, the guidelines for optical radiation in general do not differentiate between workers and the general public (ICNIRP, 2004; ICNIRP, 2013).

The time elapsed between the absorption and the biological effect is called the primary radiation effect period. Since optical radiation is absorbed in tissue, with penetration depths of a few microns for UV to millimeters for IR, it follows that it is the skin and eyes of the human body that are the most affected direct target tissues. The photochemical effects (i.e., chemical changes in target cells) dominate in the UVR and shorter wavelength visible spectral regions, while the thermal effects are dominant in the IR and visible spectral regions (ICNIRP, 2004; ICNIRP, 2013).

Photobiological reactions can be classified in two types: **Primary reactions**, which derive from the interaction between photons and the chromophores/photoreceptors, observed in the first seconds or minutes after the irradiation of light and **secondary reactions**, as response to primary reactions, in hours or even days after the irradiation occurs (Karu *et al.*, 2003). The light absorption depends on the wavelength and causes primary reactions on the mitochondria. These are followed by a cascade of secondary reactions (photosignal transduction and amplification) in the cytoplasm, membrane and nucleus (Karu *et al.*, 1987).

Light of a specific wavelength excites electrons in cellular molecules, leading to the breaking or reorganization of chemical bonds therein. In this way specific biochemical reactions as well as whole cellular metabolism can be altered. The generation of singlet oxygen ( $^1\text{O}_2$ ), and other highly-reactive free radicals (hydroxyl ( $\text{HO}\bullet$ ), anion superoxide ( $\text{O}_2^{\bullet-}$ ), peroxide ( $\text{ROO}\bullet$ ) and hydroperoxyide ( $\text{ROOH}$ )), enables the attack of the surrounding cellular molecules: proteins or deoxyribonucleic acid (DNA). They can interact with DNA causing some structural reorganization, and with other cellular targets such as retinal photoreceptors to cause deterioration of cellular function and cell death. Photochemical processes are in general dose dependent, meaning that low-level, long-term exposure gives rise to the same effect as short, higher radiance exposures (Pattison *et al.*, 2012). Depending on wavelength, different damage to DNA may occur, some of which may induce a disruption in the DNA strand, a structural reorganization, and/or deterioration of cellular function and possibly cell death (Zastrow *et al.*, 2009).

The chromophores, after light absorption in a specific wavelengths range, induce oxidative damage to various cell compartments and functions. Most of the biologically relevant molecules are in their ground state as singlet state ( $S_0$ ), (Figure 13), and by photoactivation they are promoted to an electronically excited singlet state ( $^1S^*$ ). The photoexcitation is followed by intersystem crossing (ISC) with the generation of an excited triplet state ( $^3T^*$ ) able to transfer an electron (or hydrogen atom) to/from another molecule leading to a radical pair (Type I of photosensitized damage). The energy can be transferred to another molecule, which could become chemically reactive (e.g. radicals and reactive oxygen species) (Foote, 1976).

The interaction of an excited triplet state with molecular oxygen (which is in a triplet state in its ground state) leads to an energy transfer (Type II of photosensitized damage), and oxygen is activated to an excited singlet state, called singlet oxygen ( $^1\text{O}_2$ ). The chromophores, which upon photoexcitation undergo intersystem crossing and

produce free radicals and singlet oxygen, are known as photosensitizers (PS) (Nouri, 2011).

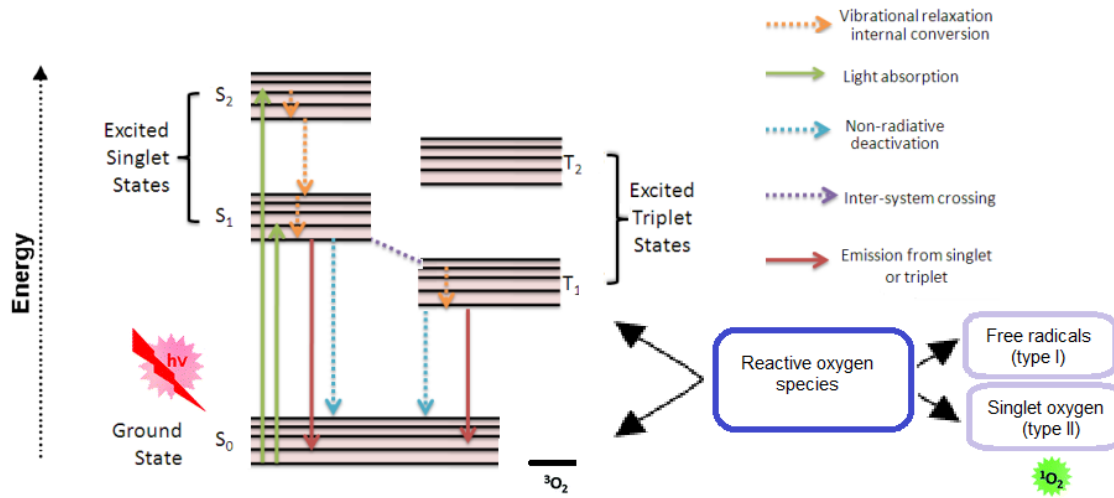

**Fig. 13: The Jablonski diagram and the photochemical generation of ROS**

### ANNEX III Structure of the skin, Fitzpatrick skin type and optical radiation effects on skin

#### Structure of the skin

The epidermis (Figure 14) is the most superficial layer of the skin. Its thickness varies from 50  $\mu\text{m}$  (eye lids) to 1.5 mm (sole of the foot). The epidermis is almost exclusively constituted from a single cell type, the keratinocytes, organized in four cell layers. The basal layer is made from a single layer of actively dividing keratinocytes, adherent to a basal membrane, and containing small keratin filaments. Interspersed within basal keratinocytes are melanocytes (1 to 5%, depending on anatomical location) that produce pigments (melanin) in specific organelles (melanosomes) and emit dendrites through the upper keratinocyte layers. Basal keratinocytes progressively differentiate and migrate to form the upper epidermis layers. Stratum spinosum are made from 5 to 15 layers of large polygonal keratinocytes, and contain some Langerhans cells (dendritic cells, involved in antigen processing). Stratum granulosum is made from 1 to 4 layers of keratinocytes; these cells become flattened, their nuclei begin to degenerate, and they contain granules of keratin precursor (keratohyalin). The most external layer of the epidermis, stratum corneum, is made from 10 to 30 layers of dead keratinocytes (corneocytes) entirely filled with keratin fibrils.

The dermis is a conjunctive tissue, of approximately 1 mm thickness. The upper part of the dermis, papillary dermis, is in contact with the epidermis basal membrane, and forms papillae that increase contact surfaces with the epidermis (rete ridges). It is highly vascularised and contains neurofibrils and sensory receptors (Pacini corpuscles). The most important part of the dermis, reticular dermis, is made from intercrossed protein networks (collagen and elastin) produced by fibroblast cells, and is vascularised in its upper part. Dermis also contains skin annexes: sweat glands, simple tubulous glands of which the extremities form glomeruli deep into the dermis or even in the sub-cutaneous tissue (their mean density is 200 glands/cm<sup>2</sup>, but may reach up to 600 glands/cm<sup>2</sup> in the forehead or in the palms), and hair follicles (actually an invagination of the epidermis) and their erector muscle and their associated oil gland (sebaceous gland).

Sub-cutaneous tissue is essentially made from fat and is vascularised.

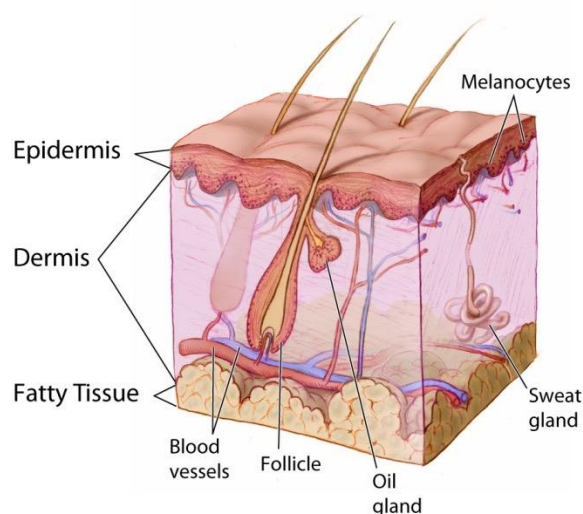

**Fig. 14: Skin and its layers**

(source: [https://commons.wikimedia.org/wiki/File:Anatomy\\_The\\_Skin\\_-\\_NCI\\_Visuals\\_Online.jpg](https://commons.wikimedia.org/wiki/File:Anatomy_The_Skin_-_NCI_Visuals_Online.jpg))



### **Fitzpatrick skin type classification**

Skin type classification has been developed to characterize skin susceptibility to solar ultraviolet radiation.

Skin phototypes have been defined by Fitzpatrick according to the answers of white-skinned volunteers exposed to 3 MEDs (approximately equivalent to 45-60 minutes of noon exposure in the northern (20° to 45°) latitudes in the early summer) to two simple questions: "How painful is your sunburn (i.e. intensity of erythema, oedema and discomfort) after 24 hours?", and "How much tan will you develop in a week?".

Originally, the Fitzpatrick classification comprised four skin phototypes. Skin Phototype I: those who burn easily and do not tan at all; Skin Phototype II: those who burn easily and tan with difficulty (freckled and often red-haired individuals); Skin Phototype III: those who burn moderately, show immediate pigment darkening reactions and tan moderately; and Skin Phototype IV: those who do not burn and develop a good tan. Later, in addition to white-skinned persons, brown-skinned (Skin Phototype V: who seldom burn and always tan) and black-skinned (Skin Phototype VI: who never burn) persons were included in the classification (Fitzpatrick, 1988) – see Table 4.

Skin phototypes are independent of hair and eye colour, e.g., although persons with skin phototype I or II, with a very pale or pale complexion, usually have blond or red hair and light-coloured eyes, but they may have dark hair or eyes.

**Table 4. Skin Phototypes (Modified from Fitzpatrick, 1988)**

<b>Phototype</b>	<b>Skin reaction to sun exposure</b>	<b>Skin colour</b>	<b>Hair colour</b>	<b>Eye colour</b>
I	Always burns, never tans	Pale, Fair	Blond	Blue
II	Usually burns, sometimes tans	Fair, Freckles	Blond, Red	Green
III	May burn, usually tans	Light Brown	Dark Blond, Light Brown	Hazel, Brown
IV	Rarely burns, always tans	Olive brown	Light Brown, Brown, Black	Dark brown
V	Seldom burns, always tans	Brown Moderate constitutional pigmentation	Dark Brown, Black	Dark brown
VI	Never burns	Black Marked constitutional pigmentation	Black	Dark brown

### **Optical radiation effects on skin**

There are no sharp lines in wavelength-dependent biological effects in the skin (Nakashima *et al.*, 2017). Thus, effects commonly known to be induced by e.g. UV-A radiation such as the DNA base damage, 7,8-dihydro-8-oxoguanine, can be induced also by wavelengths of the visible spectrum (Kvam, 1997). Another example is the induction of bulky DNA adducts such as cyclobutane pyrimidine dimers by UV-B irradiation (Lehmann, 1995), which have been shown also to be induced by UV-A in rodent cells (Rochette, 2003).

### **Benign effects of optical radiation on healthy skin**

Mild heating and erythema may occur below certain temperatures and irradiances below about 100 mW/cm<sup>2</sup> (British Standard, 2013). Sub-acute UV damage may cause loss of collagen in the dermis, termed photoaging. The action spectrum for photoaging is not well defined, but the wavelength range from UV to IR-A is suggested. There is no known threshold dose. Beneficial effects of low doses of UV exposure are pigment development through melanin production and skin hardening, both of which contribute to UV protection upon further UV exposure, as well as synthesis of vitamin D (UV-B-induced).

### **Vitamin D**

Vitamin D (a steroid hormone) is essential for human health. It is essential for bone growth and for maintaining bone strength. In addition, vitamin D plays a role in cell growth: the function of many genes is modulated by vitamin D metabolites, and many cells have vitamin D receptors.

Synthesis of pre-vitamin D<sub>3</sub> occurs in the skin from the conversion of 7-dehydrocholesterol from the keratinocytes cell membranes by UV radiation in the UV-B range (the action spectrum of vitamin D induction by UV exposure peaks at 297 nm). A thermochemical reaction leads to the formation of vitamin D<sub>3</sub> (cholecalciferol). Vitamin D<sub>3</sub> is transported to the liver and converted into its stored form, 25-hydroxyvitamin D [25(OH)D] (calcidiol), and further converted into its active form, 1,25-dihydroxyvitamin D [1,25(OH)<sub>2</sub>D] (calcitriol) in the kidneys. [It should be noted that keratinocytes are unique in being able to synthesize 1,25(OH)<sub>2</sub>D, expressing the vitamin D receptor, and responding to the 1,25(OH)<sub>2</sub>D generated (Bikle, 2012)]. Exposure of 600 cm<sup>2</sup> of the skin (i.e. the surface of face and back of hands) only needs 1/3 MED (300 J/m<sup>2</sup> for skin type III) to synthesize 400 IU (10 µg) vitamin D (Miyachi and Nakajima, 2016).

Narrow-band (full width, half maximum 10-30 nm) UV irradiation with LEDs can increase the endogenous production of vitamin D. UV-B and UV-C irradiation with an LED device effectively increases serum levels of 25(OH)D in Vitamin D-starved mice irradiated twice a week for 4 weeks at 1 kJ/m<sup>2</sup> – suberythemal – at wavelengths between 268 and 316 nm (Morita *et al.*, 2016). Barnkob *et al.* (2016) used UV LEDs in the wavelength range 280–340 nm to investigate optimal vitamin D bio-fortification in isolated pig skin fragments. A wavelength of 296 nm was found to be optimal for vitamin D<sub>3</sub> production. The maximum dose of 20 kJ/m<sup>2</sup> produced 3.5–4 µg vitamin D<sub>3</sub>/cm<sup>2</sup> pig skin.

### **Malignant effects of optical radiation on healthy skin**

#### **Photothermal**

Thermal pain is induced by skin temperatures greater than about 45°C (ICNIRP, 2013) (corresponding to about 100 mW/cm<sup>2</sup> (British Standard, 2013)). At this temperature and irradiance levels reversible or irreversible damage to skin structures can occur. The damage is accompanied by an inflammatory reaction in the skin. Normally, the aversion response limits exposure durations. However, in anaesthetised persons the aversion response may be compromised. This situation is unlikely to be relevant for exposure

from non-medical devices. On the other hand, during occupational exposure workers may be prone to exceed the thermal limits. A skin condition caused by regular localised heating of the skin resulting in a reddish-brown colour, called erythema ab igne, may indicate thermal damage of the skin. The presence of such erythematous damage may increase the risk of skin cancer development in the presence of carcinogenic chemicals or UV radiation exposure. The threshold doses to induce erythema ab igne may be below the thresholds of thermal pain (ICNIRP, 2013). If saunas and warming cabinets are equipped with IR-LEDs, these devices may cause erythema below the pain limit.

The SCHEER concludes that thermal effects from visible and IR-emitting lighting sources are unlikely to cause adverse health effects in healthy skin from LEDs intended for lighting purposes and displays. However, there may be effects due to excessively intense sources close to the source, such as from high irradiance (near-) IR sources.

## Photochemical

### Sunburn, erythema and cancers

UV-B and UV-A exposure can induce delayed and immediate sunburn reactions (erythema), respectively, accompanied by inflammatory reactions. The erythematous action spectrum is defined in a standard by the Commission Internationale de l'Éclairage (CIE 1998; ISO / CIE 1999).

Melanoma and non-melanoma skin cancers are the most common types of cancer in the Caucasian population. The very common actinic keratosis (AK) (pre-cancer) can be induced by cumulative solar and artificial UV radiation, as well as by exposure to polycyclic aromatic hydrocarbons. Precise prevalence and incidence figures are often unavailable as the lesions are not commonly reported to cancer registries. AK occurs mostly in skin types I-II (see Table 5). In a Dutch study at least one AK lesion was found in 38% of all subjects investigated above 50 years of age (Flohil *et al.*, 2013). AK is the most common precursor of SCC in Caucasians (Dermatology Information System - DermIS). Basal cell carcinoma (BCC) is induced by UV radiation, chemical carcinogens (e.g. arsenic), immunosuppression and genetic disorders, such as some of the photodermatoses (see Annex III, Photodermatoses). BCC is the most common skin tumour in humans and it seldom metastasises. Seventy-five percent of carcinomas occur in patients over 40 years of age. Cancer registries often exclude non-melanoma skin cancers. In South Wales, United Kingdom, the age-standardised incidence rates per 100 000 population in 1998 were 127.9 for men and 104.8 for women (Holme *et al.*, 2000 in DermIS). Corresponding Danish numbers (per 100,000 person-years) for men and women in 2007 were 91.2 and 96.6, respectively (SCENIHR, 2012). The association between severe sunburns and basal cell carcinomas is likely (SCENIHR 2012), but the pathogenetic pathways of UV-B and UV-A radiation for basal cell carcinomas development need to be clarified (Calzavara-Pinton, 2015). Pathogenetic factors for squamous cell carcinoma (SCC) tumours (metastasising) are UV radiation, chronic inflammatory skin changes, chemical carcinogens, immunosuppression, as well as viral infections. In South Wales, United Kingdom, the age-standardised incidence rates per 100,000 population in 1998 were 25.2 for men and 8.6 for women (Holme *et al.*, 2000). Corresponding Danish numbers (per 100,000 person-years) from 2007 were 19.1 and 12.0, respectively (SCENIHR 2012). Intermittent sun exposure and a history of sunburns, a predictor of intermittent exposure, increase the risk of cutaneous malignant melanoma (CMM) (SCENIHR 2012, Ghasvand, 2016). The pathologic factors for this skin tumour are sun exposure (intermittent burning), artificial UV exposure, as well as phenotypic (fair skin) and genetic nature (in patients with e.g. xeroderma pigmentosum). CMM occurrence is increasing with ambient annual erythemal dose. It is the most frequent cause of death due to a skin disease. In Norway, where the age-standardised incidence rates are similar to those of Australia, the 2016-figures (per 100 000) were 42.2 for men and 38.3 for women (Cancer Registry of Norway, 2017). CMM

incidence has increased faster than any other cancer in white populations during the past decades (Ghiasvand, 2016).

### **Immunosuppression**

UV irradiation of the skin has an immunosuppressive effect. Both overexposure and sub-acute doses (<1 MED) can suppress adaptive cellular immunity (i.e. acquired immunity against a pathogenic agent or substance and effected by direct cell-to-cell contact). The immunosuppressive effects of UV radiation, in particular wavelengths shorter than about 320 nm, have been shown in several studies (reviewed by Schwartz, 2008). In animal studies such UV-induced suppression contributed to skin cancer formation and aggravation of bacterial/viral infections (Norval 2006b in SCENIHR, 2012). In humans, UV overexposure may cause flare-ups of herpes simplex viruses (Norval 2006a, Sayre *et al.*, 2007, both in SCENIHR 2012). In humans, the suppressive effects of UV on skin immune status occur in the UV-B (around 300 nm) as well as in the UV-A (around 370 nm) range (Halliday *et al.*, 2012).

One of the mechanisms is via the immunologically important lymphocytic cells: UV irradiation activates the regulatory T and B cells (Halliday *et al.*, 2012). Urocanic acid, found predominantly in the stratum corneum of the epidermis, acts as an endogenous sunscreen by absorbing UV-B radiation. When exposed to UV-B irradiation, trans-urocanic acid is converted to the cis-isomer which activates regulatory T cells and suppresses induction of immunity in human skin (Dahl *et al.*, 2010).

UV exposure also has the ability to enhance the innate immune response (inborn defence against infectious agents). UV exposure increases levels of anti-bacterial proteins in the skin (Gläser *et al.*, 2009 in SCENIHR, 2012) which may explain why solar exposure does not favour bacterial infections in general (Liu *et al.*, 2006, SCENIHR, 2015).

### **Non-melanoma skin cancers and exposure to UV nail light**

Nail curers uses UV-A radiation to solidify nail polish and/or set acrylic nails. UV-A radiation is provided by small devices, rather inexpensive (from ca. 30 to 100 €), that can be used either in professional nail care salons or at home. For decades these devices have been fitted with fluorescent lamps emitting broad band UV-A (320 to 400 nm) and of a typical power of 36 W. More recently, UV LEDs have been introduced, that emit a narrower UV spectrum (375 to 420 nm), and of a typical power of 14 W.

Concern about the safety of this procedure was triggered by MacFarlane and Alonso (2009), who reported the occurrence of non-melanoma skin cancers on the hands after UV nail light exposure in two women. The first patient was a 55-year-old white woman with no specific risk factors (little recreational UV exposure, no solar damage, and no preceding human papillomavirus infection) who developed a squamous cell carcinoma in situ on the dorsal aspect of her right index finger and had a 15-year history of twice-monthly UV nail light exposure. The other patient was a 48-year-old white woman who developed a squamous cell carcinoma on the dorsum of her right hand. This patient, with moderate recreational UV exposure and no personal or family history of skin cancer, had a Fitzpatrick skin type III, with several actinic keratoses on her face and arms. There was no preceding human papillomavirus infection at this site or elsewhere. Questioning revealed previous exposure to UV nail lights approximately 8 times in 1 year, several years before her first skin cancer.

To evaluate the actual risk of skin cancer associated with exposure to UV-A lamps used in cosmetic nail treatment, Diffey (2012) constructed a mathematical model that combined age and UV exposure to compare the risk of developing SCC due to typical sun exposure with the risk of inducing these cancers from exposure to UV-A nail lamps. Calculations were based upon actual measurements of UV irradiance of a typical 18 watts device, giving an erythemally weighted output of 1.58 SED h<sup>-1</sup> [Standard Erythema

Dose, a measure of erythematous UV radiation exposure dose], and upon the assumption of a session every 3 weeks, i.e. an annual exposure dose of 3.8 SED [this dose can be compared to an estimation of a median baseline sun exposure level of 166 SED year + 85.5 SED per year holiday (SCHEER, 2016)]. Results were expressed as number needed to harm (NNH) and indicate that the risk of inducing an SCC from exposure to UV-A nail lamps is very low for a typical usage, since tens or hundreds of thousands of women would need to use a UV-A nail lamp regularly for one to go on to develop SCC on the dorsum of the hands as a direct consequence. Moreover, this risk can even be reduced to virtually zero by wearing fingerless gloves when the hands are being exposed.

Risk calculations by Diffey were based on measured irradiance of a single device fitted with fluorescent lamps of relatively small power. Markova and Weinstock (2013) measured the spectral irradiance of three common UV Nail Lamp devices: two fitted with broadband UV-A fluorescent bulbs (respectively 36 W with a peak emission at 368 nm, and 9 W with a peak emission at 370 nm), and one fitted with UV LEDs (405 nm, 6 W). They then used the action spectrum for human photocarcinogenesis (de Gruijl and Van der Leun, 1994) to determine the carcinogenic-effective irradiance of a 10 min UV nail lamp session and compare it with that of a single narrowband UV-B phototherapy course, a commonly used dermatological treatment, viewed as low risk for the development of nonmelanoma skin cancer. They calculated that over 13,000 fluorescent lamp and more than 40,000 UV-A LED sessions would be required to equal at the nail plane the UV dose received during one narrowband UV-B course, which represents over 250 years of weekly UV nail sessions to experience the same risk exposure.

Following a request from the Nail Manufacturers Council on Safety (an organization formed by the nonprofit trade association, the Professional Beauty Association), Dowdy and Sayre (2013) conducted a photobiological safety evaluation of six nail curing lamps. Radiant hazards were assessed as defined in ANSI/IESNA RP-27 Recommended Practice for Photobiological Safety. Three of the devices evaluated were fluorescent UV nail lamp systems incorporating 2, 3 or 4 small 9 W lamps. The other three devices were LED-based incorporating arrays of 6 or 32 LEDs or 1 LED (single finger unit). Lamps were evaluated at three positions, 1 cm above the inner surface (approximating exposure to the hand) and the 20 cm RP-27 non-general light source distance, oriented 0° and 45° to the opening. At 1 cm distance, weighted Actinic UV ranged 1.2–1.7  $\mu\text{W cm}^{-2}$ , classifying these devices into RP-27 Risk Group 1 (Low - for the finger unit) or 2 (Moderate); which corresponds to 29.8–276.25 min permissible daily exposure [the RP-27 risk group classification is based on an occupational exposure assumption]. At 20 cm on centre and 45°, actinic UV ranged 0.001–0.078  $\mu\text{W cm}^{-2}$  and unweighted near UV (320–400 nm) ranged 0.001–0.483  $\text{mW cm}^{-2}$ , and UV risk to skin and eyes were all within the Exempt classification. Likewise the retinal photochemical blue light hazard and retinal thermal and cornea/lens IR were also Exempt. According to this evaluation, the total exposure incurred during a typical nail lamp session represents a small fraction of the RP-27 permissible daily occupational exposure.

Shipp *et al.* (2014) measured the unweighted UV-A irradiance of 17 nail polish drying devices (in 16 salons), and evaluated the potential risk to the user by comparison with an energy density of UV-A shown to induce DNA damage (60  $\text{J cm}^{-2}$ ). The median UV-A exposure for a single visit was low (5.1  $\text{J cm}^{-2}$ ). These data suggest that the risk for carcinogenesis remain small. [It should be noted that the devices measured by Shipp *et al.* appear to have been fitted with fluorescent lamps].

In a research letter, Curtis *et al.* (2013) evaluated two nail curing lamps – not LEDs - and found that total MED (Minimum Erythema Dose) per session was 0.1 MED or less, representing annual doses of 1.1 to 1.5 MED, and raised the possibility that long-term exposure to UV nail lamps may have the potential to increase both cancer risk and photoaging.

Thus, regardless the metrics chosen, UV nail lamps and/or LEDs do not appear to significantly increase the lifetime risk of non-melanoma skin cancer. However, data are

lacking regarding the possibility of premature skin ageing, and the risk to the eyes of the professional operators should be considered.

The SCHEER is not aware of UV-LEDs in tanning equipment, but such devices would have the same carcinogenic potential as conventional sources provided the same level of irradiance is received as from the radiation sources that the UV-LEDs have replaced. Cancer is not likely to develop from nail-curing LED-devices if the risk is not already increased in susceptible individuals.

## **Optical radiation effects in pathological conditions**

### **Photodermatoses**

It is reasonable to believe that patients diagnosed with a known photosensitivity disorder will avoid the radiation responsible for their symptoms. However, UV exposure may both relieve and aggravate symptoms in patients with conditions such as acne, psoriasis and atopic dermatitis. Also some viral infections, such as herpes simplex virus, can sometimes be exacerbated by UV. Individuals who experience intermittent or infrequent outbreaks of their condition may not avoid UV exposure at all times. Many lupus erythematosus patients may not be aware of their photosensitivity (SCENIHR, 2012) and therefore, will not always avoid UV exposure. Indoor lighting-triggered disease activity has been reported previously (SCENIHR, 2012).

The SCENIHR opinion on artificial light (2012) provides a comprehensive, yet not exhaustive list of various photodermatoses. Below, only a few of the most commonly occurring diseases/conditions are mentioned. A majority of both optical radiation-induced and -aggravated photodermatoses listed in the previous Opinion (SCENIHR, 2012) manifest with possible or established ocular involvement (Rambhatla *et al.*, 2015).

#### **A. Diseases induced by optical radiation**

The wavelength dependency of some optical radiation-induced photodermatoses is presented in Table 6. The prevalence Figures presented below for the various diseases were found at <http://www.orpha.net/> if not specified otherwise.

##### **1. Idiopathic or immune-based**

Actinic prurigo can have childhood onset or onset before 20 years of age. The prevalence varies from 0.003% in Scotland to 8% in Chimila Indians of Colombia (Valbuena *et al.*, 2014). Chronic actinic dermatitis (CAD) is an uncommon dermatitis thought to be a delayed-type hypersensitivity response against photo-induced cutaneous antigens, similar to allergic contact dermatitis (Rambhatla *et al.*, 2015). CAD has adult onset. Prevalence is estimated to 1-5 in 10 000. Hydroa vacciniforme is a rare photodermatosis with childhood onset (Rambhatla *et al.*, 2015). Indicated prevalence is 1-9 in 1 000 000. Lupus erythematosus can have various sub-types (see SCENIHR, 2012). They can have childhood onset and affect all age groups. Systemic lupus erythematosus (SLE) has prevalence in Europe of 12.5-39 per 100 000 (SCENIHR, 2012) while autosomal recessive SLE has a prevalence of <1 in 1 000 000. Polymorphic light eruption (PLE) can have childhood onset, but mean onset is in the second or third decade of life. PLE is the most common photodermatosis. In European countries the prevalence is up to 20% (Gruber-Wackernagel *et al.*, 2014). PLE affects mostly women, and a prevalence of 33.4% in females of skin type I was reported by Rhodes *et al.* (2010) in Europe. Solar urticaria is an uncommon condition that affects all ages, but with a peak during the fourth and fifth decades of life (Rambhatla *et al.*, 2015). Prevalence numbers are stated as 36 per 100 000 (orpha.net, 2016).

## 2. Genophotodermatoses

The diverse group of inherited photosensitive diseases is rare, and the diseases present with various wavelength susceptibility (SCENIHR, 2012). Xeroderma pigmentosum (XP) is characterised by defective DNA repair mechanism for UV damage associated with chromosome instability. XP has a prevalence of 1 in 1 000 000 in the USA and Europe, with higher Figures in other countries and continents particularly in communities with a high degree of consanguinity (orpha.net, 2011). Birth prevalence is 0.23 per 100 000 in Europe (Orphanet Report Series, 2016).

## 3. Porphyrrias

Porphyrias constitute a group of disorders related to enzymatic defects in the haem synthesis (Rimington, 1985). These result in increased synthesis of porphyrins and for some of the diseases, with possible cutaneous photosensitisation. The porphyrin absorption range is about 320-600 nm with the largest absorption maximum about 400 nm and smaller maxima between about 500-700 nm. Hepatocytes and bone marrow erythroblasts are the major cell types involved in haem synthesis and thus, enzymatic defects will be manifested in these cells (Rimington, 1985; Sassa, 2006). Six of the nine porphyrias described are associated with photosensitivity. Two of these are among the second and third most often occurring types. They can be of either erythropoietic or hepatic type or both (Sassa, 2006). The skin localisation of porphyrins of hepatic or erythrocyte origin is dependent on the water solubility of the porphyrins (Brun *et al.*, 1991) and not necessarily the depth at which they accumulate. Thus, knowing the type of porphyria in a patient cannot indicate "safe" wavelengths within the porphyria absorption spectrum by choosing "appropriate" penetration depths. Porphyrias are, in general, rare diseases and prevalence and incidence vary between type of porphyria and country (Table 6). As an example, erythropoietic protoporphyria (EPP), an autosomal recessive disease, has been described worldwide. The prevalence of EPP may vary based on the population allele frequency of the low-expression IVS3-48T>C allele, which ranges from approximately 1% in African Americans to approximately 43% in Japanese (Balwani *et al.*, 2012).



**Table 5: Prevalence and incidence of photosensitive porphyrias. Total incidence of all porphyrias in Denmark is 0.52 in 100000 per year 1989-2013 (Christiansen *et al.*, 2016) a) Most common porphyria in children, third most common of all porphyrias. b) Holme *et al.*, 2006**

Porphyria	Prevalence per million inhabitants (95% CI) if not otherwise stated	Geographic location	Reference	Prevalence, per million inhabitants Ref : orpha.net (year)	Incidence per million inhabitants (95% CI) if not otherwise stated	Geographic location	Reference
Variegate porphyria	3.2 (2.4-4.0)	11 European countries	Elder <i>et al.</i> , 2013	1-9 (2009)	0.08 (0.06-0.10)	11 European countries	Elder <i>et al.</i> , 2013 (2007-2009)
	Low: 0.4 High: 10.4	Poland Switzerland			Low: 0.01 High: 0.26	Poland Switzerland	
					9 (1989-2013)	Denmark	
Erythropoietic protoporphyria <sup>a)</sup>	9.2 (7.7-11.6)	11 European countries	Elder <i>et al.</i> , 2013	1-9 (between 1/75000 in the Netherlands and 1/200000 in Wales <sup>b)</sup> (2013))	1) 2-5 2) 0.12 (0.10-0.15)		1) Pagon <i>et al.</i> , 2014 2) Elder <i>et al.</i> , 2013 (2007-2009)
	Low: 1.5 High: 27.7	Poland Norway			Low: 0.03 High: 0.36	Poland/ Spain Norway	
					73 (13 per million) (1989-2013)	Denmark	

Potential risks to human health of LEDs

Final Opinion

Porphyria cutanea tarda	1 per 10 000	Sweden, Norway	Rossmann-Ringdahl <i>et al.</i> , 2005; Mykletun <i>et al.</i> , 2014	1/25000 Western Europe (2009)	650 (1 per 10 000) (1989-2013)	Denmark	Christiansen <i>et al.</i> , 2016
Hereditary coproporhyria	1 per 100 000	Czech Republic	Martásek, 1998	1/1 mill (2009)	4 (1989-2013)	Denmark	Christiansen <i>et al.</i> , 2016
Congenital erythropoietic porphyria					1 (1989-2013)	Denmark	Christiansen <i>et al.</i> , 2016

#### 4. Photosensitivity with exogenous origin

Photosensitivity can be induced by skin exposure to plant and vegetable compounds (phytophotodermatitis), drugs, chemicals and cosmetics, all in combination with optical radiation. The most common mechanism for photosensitivity induced by drugs is phototoxicity, while a less frequent mechanism is photoallergy. Photoallergic contact dermatitis is a delayed-type hypersensitivity reaction in susceptible individuals. Most of these drugs or chemicals cause reactions after UV-A exposure although some can cause sensitisation with UV-B radiation or visible light (SCENIHR, 2012). A list of drugs associated with photosensitivity is provided by Valbuena *et al.* (2014) and a list of drugs and other compounds absorbing in the 290-700 nm wavelength range exhibiting phototoxicity can be found in Kleinman *et al.* (2010).

Photosensitisers used in photodynamic therapy of various cancers can elicit reversible skin phototoxic responses upon subsequent exposure to visible radiation (SCENIHR, 2012), such as from artificial light sources including LEDs.

##### A. Photo-aggravated dermatoses

This is a large and diverse group of diseases which are not primarily caused by optical radiation, but which can be exacerbated by such radiation. Examples of diseases and conditions are listed in e.g. SCENIHR 2012 and Rambhatla *et al.* (2015). Mechanisms of disease and wavelength dependence are not always known.

##### B. Susceptible groups

Children in general and persons affected by photodermatoses are susceptible to excessive optical radiation exposure of their skin. Childhood onset can occur for e.g. actinic prurigo, hydroa vacciniforme, lupus erythematosus, polymorphic light eruption, solar urticaria and xeroderma pigmentosum. Photosensitivity occurs in children for (at least) the following porphyrias: erythropoietic protoporphyria, congenital erythropoietic porphyria and hepatoerythropoietic porphyria.

**Table 6: Wavelength dependency in photodermatoses (amended from Table 5 in SCENIHR, 2012) \*Established or possible ocular involvement (Rambhatla et al., 2015)**

Classification	Photodermatosis	Wavelengths (nm)			
		UV-B (280-315)	UV-A (315-400)	Visible blue (400-500)	Visible green-red (500-780)
"Light"-induced, endogenous	Actinic prurigo*				
	Chronic actinic dermatitis*			(seldom)	
	Hydroa vacciniforme*				
	Lupus erythematosus* (may also be photoaggravated)		(UV-A?)		
	Polymorphic light eruption				
	Porphyria				
	Solar urticaria*				(green light?)
	Xeroderma pigmentosum*				
"Light"-induced, exogenous	Drug-/chemical-induced*			(few)	
	Photoallergic contact dermatitis				

### Conclusions on photodermatoses

Prevalence and incidence figures vary substantially between type of porphyria and country. The absorption spectrum of the porphyrins present in patients with photosensitive porphyrias overlaps the emission spectra of LED lighting sources. The SCHEER could not find evidence for increases in the incidence of porphyrias and photodermatoses since the publication of the Opinion on artificial light (SCENIHR, 2012). Theoretically, the incidence of the chemical/drug-induced types of porphyrias and induction and aggravation of any of the photodermatoses may increase with increased light exposure in general. Although it seems possible to elicit certain visible-light-induced

photosensitivity disorders with LED lighting sources, it must be kept in mind that these diseases are rare.

## ANNEX IV Photometry, Radiometry and Dosimetry

### Photometry and Radiometry

Photometry is the science of the measurement of light, in terms of its perceived brightness to the human eye. It is distinct from radiometry, which is the science of measurement of radiant energy (including light) in terms of absolute power. Concepts such as radiance, irradiance, radiant power and radiant intensity used in radiometry can easily be defined via simple geometric relationships. While sharing these identical relationships, photometry also introduces detector response modelled after human visual characteristics.

Power (watts) is converted to luminous flux in lumens via the integral equation:

$$\Phi_v = K \int_{380}^{780} P_e(\lambda)V(\lambda)d\lambda,$$

where  $V(\lambda)$  is the photopic response function of the human eye in day light,

$\Phi_v$  = flux (lumens),  $P_e$  = power,  $K$  = constant (683 lm/W for photopic). The unit of luminous flux is the lumen.

### Dosimetry

The emissions from an LED source can be quantified in terms of radiant power (watts). This should not be confused with the electrical input power used historically to specify incandescent lamps. The radiant power is usually the total emission of the source and is most appropriate for sources that emit equally in all directions. If the source is directional then it is more appropriate to specify the radiant intensity (watts per steradian) and if the source is not a point source, radiance (watts per square metre [of emitter] per steradian). These quantities are radiometric quantities and are appropriate across the optical spectrum (for ultraviolet, visible and infrared emissions).

It may also be appropriate to specify a spectral quantity to show how the contributions to the above quantities vary with wavelength – the emission spectrum.

With the spectral information, it is possible to weight the emission for a range of factors to take into account human (or other) responses. The response of the eye to optical radiation at different wavelengths has been experimentally determined and weighting with the response function, particularly for high light levels, gives the photometric quantities. Luminous flux (lumen) is equivalent to radiant power, weighted at each wavelength with the luminous efficacy function and summed across all wavelengths. The equivalent quantities for radiant intensity and radiance are luminous intensity (lumen per steradian, or candela) and luminance (lumen per metre squared per steradian, or candela per metre squared), respectively.

All of these quantities are parameters associated with the actual source or a virtual source (due to the use of a diffuser or reflectors).

The optical radiation incident on a surface, which could be the eye or the skin, is quantified in terms of irradiance (watts per square metre). The equivalent photometric quantity is illuminance (lumen per square metre, or lux). Since radiance is generally

conserved in an optical system, the radiance on the retina will generally be the same as the radiance of the source.

Spectral data for the optical radiation incident on a surface, for example in watts per square metre per nanometre, can be used to weight for a range of hazard or beneficial effects. In this Opinion, reference is made to a number of studies, which suggest that the blue emission from LEDs may be of concern. The International Commission on Non-Ionizing Radiation Protection (ICNIRP, 2013) has published guidelines on limits for exposure to blue light, which take into account the effectiveness of optical radiation to cause adverse effects at different wavelengths.

The spectral irradiance from an LED source is weighted at each wavelength and the resulting weighted spectrum is summed for comparison with the ICNIRP exposure limit. Since the weighting function peaks at about 440 nm, decreasing by a factor of ten for wavelengths less than 400 nm and greater than 500 nm, any incident blue radiation is more significant. This is shown in Fig. 15.

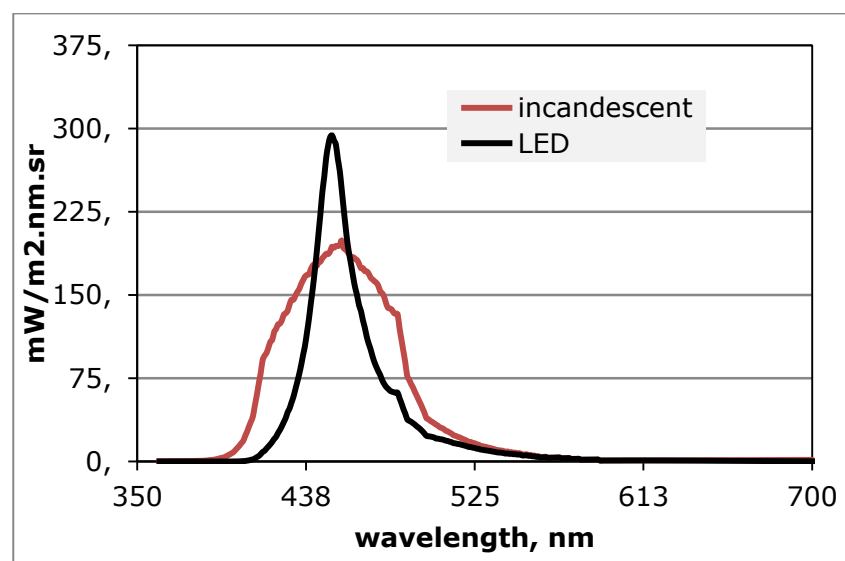

**Fig. 15: Emission spectra from an LED and an incandescent lamp (in Figure 3), weighted with the blue light action spectrum (source: John O'Hagan, 2017)**

Fig. 15 shows the weighted (for blue light hazard, Fig.7) spectral radiance of the incandescent lamp and LED lamp shown in Fig. 3. When the values were summed, the weighted radiance was  $14 \text{ W m}^{-2} \text{ sr}^{-1}$  for the LED lamp and  $10 \text{ W m}^{-2} \text{ sr}^{-1}$  for the incandescent lamp. The ICNIRP exposure limit for long-term exposure ( $> 10000 \text{ s}$  or about 3 hours) is  $100 \text{ W m}^{-2} \text{ sr}^{-1}$ .

Most lighting sources are not directly visible to observers in order to avoid a glare source. Sources may be shielded or fitted with diffusers. The exceptions are indicator devices and, for example, vehicle lighting, which is in the direct field of view, and illuminated screens. Therefore, the general exposure condition is to indirect optical radiation. ICNIRP provides a general rule for white light sources, which is that if the luminance is less than  $10^4 \text{ cd m}^{-2}$ , it is unlikely to be a hazard. Screens are usually up to about 4% of this luminance (O'Hagan *et al.* 2016).

## ANNEX V Circadian rhythm

### Generation of the circadian rhythm

The biological clock consists of multiple 'clocks': 1) the central clock in the brain (the suprachiasmatic nucleus or SCN) and 2) peripheral clocks in almost all organs including heart, liver and kidneys. The peripheral clocks are regulated by the central clock (Dibner, Schibler et al. 2010). A self-sustaining molecular oscillator generates the circadian rhythms at a cellular level. This oscillator comprises genes and proteins that are organized in positive and negative transcription and translation feedback loops (Takahashi, 2017). In short, the heterodimer transcription factor CLOCK/BMAL1 drives the transcription of the *Period* and *Cryptochrome* genes. The proteins translated from these transcripts gradually accumulate in the nucleus and shut down the expression of their own genes by repressing the transcription of the CLOCK/BMAL1 heterodimer. This process is influenced by post-translational modifications that affect the stability of the clock proteins and, thereby, influence the periodicity of circadian rhythms. In turn, this determines, for example, a person's chronotype (i.e. a morning or evening person) (Takahashi, 2017).

### Function of circadian rhythms

Circadian rhythms most likely evolved to adapt and respond optimally to daily environmental cycles. It enables anticipation to expected events and ensures that bodily processes occur in a temporal and synchronized fashion at the most optimal timing related to the environment. A simplified example: eating when food is present and subsequently optimize metabolism processes after eating. The bodily processes regulated in a circadian fashion are widespread and linked. Ranging from behaviour (sleep/wake cycles), cognition (attention, concentration), the immune system and repair mechanisms, to numerous physiological processes including endocrine functioning, metabolism, cardiovascular functioning etc. It has been shown that circadian rhythms occur in 2-10% of a tissue's molecular processes and, in addition, several post-transcriptional mechanisms result in circadian rhythms in protein expression (Takahashi 2017).

### Measuring circadian rhythms in humans

To determine if circadian rhythms are influenced by external stimuli, several biomarkers for circadian rhythms are usually investigated. These include body temperature, melatonin and cortisol, of which melatonin is the most widespread used marker. Melatonin is one of the hormones with a robust circadian rhythm and its levels are easily assessed using saliva, serum or urine. The timing of melatonin production from the pineal gland is directly regulated by the central clock in the brain, the SCN. During night time, norepinephrine is released from sympathetic nerve endings to the pineal gland which regulates the key enzyme in melatonin production, arylalkylamine N-acetyltransferase (AANAT) (Schomerus and Korf 2005). Melatonin levels rise during the dark period and decrease at the end of the dark period. However, regulation of melatonin is not only via light/dark, since melatonin levels decrease towards the end of the night when no light is present and darkness during the day will not result in melatonin production. As such, melatonin levels are often used as a marker for a person's circadian phase, although this relation involves other aspects as well. Exposure to light at night reduces the production of melatonin, since norepinephrine levels drop (Schomerus and Korf 2005), but changes in circadian phase depend on other aspects as well (light during the day and other zeitgebers, such as food). Melatonin also rises at night in nocturnal animals, and, as such, it is better described as a hormone of the night, rather than a sleep hormone.



**Consequences of disturbance of the circadian rhythm by light**

As described in section 6.8.1 negative health effects of optical radiation from LEDs, specifically, have not been investigated. It is expected that these effects are not LED-specific; they apply to exposure to light during the evening that influences the circadian system in general. The effects may, however, be enhanced or reduced for LEDs compared to traditional light sources at similar illumination levels, due to the particular spectral emission pattern of certain types of LEDs. In addition, it is important to note that direct causal relations of the use of LEDs or other artificial light sources during the evening on health have not been investigated. Indications are obtained from association studies, circumstantial evidence and hypothesized effects based on studies investigating other types of circadian disturbance.

Disturbance of the circadian system has been associated with several negative health effects. This is mainly the case for relatively severe disturbances of the circadian system that, for example, occur due to shift work or jetlag. For example, circadian disturbance as is commonly caused by shift work has been associated with cancer, metabolic health effects, and cognitive functioning (IARC 2010, Wang, Armstrong et al. 2011, ANSES 2016, Mattis and Sehgal 2016). Although the circadian disturbance observed due to evening light exposure is less severe, some underlying mechanisms and consequences might be similar.

An important consequence of the circadian disturbance due to light during the evening is its effect on sleep. As described in more detail above, the studies by Cajochen *et al.* and Chang *et al.* indicate that use of certain types of LEDs, similar to other artificial light sources, can result in reduced sleepiness (Cajochen, Frey et al. 2011, Chang, et al. 2015) and increased latency to sleep (Chang, et al. 2015), possibly causing shorter sleep duration and poorer sleep quality. It is important to note that, regardless of the cause (i.e. being artificial light or other factors), reduced sleep duration and quality is associated with poorer cognitive performance, fatigue, altered mood and increased health and safety risks (Christoffersson, Vagesjo et al. 2014, Engle-Friedman 2014, Burke, Scheer et al. 2015, Cedernaes, Schioth et al. 2015).

Furthermore, additional light during the evening has been hypothesized to phase delay circadian rhythms. Delay in the circadian rhythm can result in 'social jetlag'. This refers to the phenomenon that the circadian rhythm is delayed but the social environment requires behavioural patterns to remain at the earlier phase (Wittmann, Dinich et al. 2006). In other words, a person still has to get up early in the morning to go to work/school. This can cause several important bodily processes to occur 'out of sync' with the biological clock, such as food consumption. This desynchronization of external and internal stimuli might be underlying some of the health effects related to disturbances of the circadian system. Social jetlag has mainly been associated with risk factors for cardio-metabolic diseases (Parsons, Moffitt et al. 2015, Wong, Hasler et al. 2015). Furthermore, evening light exposure might enhance delayed sleep-wake phase disorder (DSWPD) in sensitive persons. This disorder is characterized by late sleep and wake times and poorer sleep quality (Joo, Abbott et al. 2017, Magee, Marbas et al. 2016).

In addition to observed effects of evening light on sleep in experimental settings, it has been suggested that evening exposure to light might have a direct effect on food consumption and metabolism (Versteeg, Stenvers et al. 2016). It has been hypothesized that evening light causes increased food consumption at unfavourable moments (i.e. when metabolism processes are in their rest phase). In addition, an association has been observed between melatonin levels and metabolic disorders. Melatonin might have a direct effect on food intake and melatonin receptors are also present on pancreatic cells.

Polymorphisms in the melatonin receptor have been associated with increased risk of type 2 diabetes (Versteeg, Stenvers et al. 2016).

In summary, disturbances of the circadian rhythm can result in negative consequences on sleep, cognitive performance and, in the long term, on metabolic risk factors. However, most of the described experimental studies are performed in laboratory settings and using protocols that do not readily translate to normal exposures and behaviours. Furthermore, since no experimental studies have been performed with chronic exposure (multiple years) to artificial light during the evening, it is currently unknown if the disturbance of the circadian rhythm remains, increases or reduces after chronic exposure to light during the evening.

**ANNEX VI Hazardous waste due to the materials used for producing Light-Emitting Diodes (LEDs)**

A South Korean/U.S. investigation on the toxic potential of LEDs, CFLs and incandescent lamps, found that in comparing the bulbs on an equivalent quantity basis with respect to the expected lifetimes of the bulbs, the CFLs and LEDs have 3-26 and 2-3 times higher toxicity potential impacts than the incandescent bulb, respectively (Lim *et al.*, 2011). Arsenic, present as gallium arsenide, is found in light emitting diodes (LEDs). The element is a human carcinogen and exposure to arsenic can result in various skin diseases and can decrease nerve conduction velocity<sup>6</sup>. Lead is a potent neurotoxin, and short-term exposure to high concentrations of lead can cause vomiting, diarrhoea, convulsions and damage to the kidney and reproductive system. It can also cause anaemia, increased blood pressure, and induce miscarriage for pregnant women. Children are considered to be particularly vulnerable to exposure to lead, for it can damage nervous connections and cause brain disorders<sup>7</sup>.

Except for these heavy metals, TBBA (tetrabromobisphenol-A), PBB (polybrominated biphenyls) and PBDE (polybrominated diphenyl ethers) could be encountered as fire retardants for plastics (thermoplastic components, cable insulation). TBBA is presently the most widely used flame retardant in printed wiring boards and covers for components - brominated flame retardants (BFRs). The combustion of these halogenated compounds releases toxic emissions including dioxins which can cause reproductive and developmental problems, damage the immune system, interfere with hormones and also cause cancer<sup>8</sup>.

Polyvinyl chloride (PVC) is mainly found in the plastic components of electrical and electronic equipment. When burned, PVC releases dioxins, furans and phthalates, some of which are known reproductive toxicants and carcinogens (Hazardous substances in e-wastes., 2009).<sup>9</sup>

Phthalates used as softeners to PVC can easily leach into the environment. Epidemiological data has suggested an association between indoor exposure to phthalates and asthmatic and allergic reactions in children (Bornehag *et al.*, 2010)

---

<sup>6</sup> World Health Organization (WHO), Arsenic, Fact Sheet 372 (June 2016)  
<http://www.who.int/mediacentre/factsheets/fs372/en/>

<sup>7</sup> World Health Organization (WHO), Lead poisoning and health, Fact Sheet 379 (September 2016)  
<http://www.who.int/mediacentre/factsheets/fs379/en/>

<sup>8</sup> World Health Organization (WHO), Dioxins and their effects on human health, Fact Sheet 225 (October 2016)  
<http://www.who.int/mediacentre/factsheets/fs225/en/>

<sup>9</sup> Hazardous substances in e-wastes, (2009). Retrieved May 17, 2015 at <http://ewasteguide.info/hazardous-substances>.

## **ANNEX VII: Literature review**

Comprehensive literature searching involved capturing the scientific literature about the LED effects on skin, eye, retina, macula, cornea, lens tear film, circadian rhythm, circadian disruption, melatonin suppression.

### **Search strategy and selection of publications**

#### **Example Topic: circadian effects (Search EC library and e-resources centre)**

Selection on Title of the following topics: 19 references

Circadian rhythm: 8 out of 12

Blue light AND circadian AND human: 1 out of 9

Blue light AND circadian disruption: 4 out of 15

LED AND circadian rhythm: 2 out of 2

Melatonin suppression: 4 out of 16

Circadian light: 0 out of 3

Based on abstracts, 9 papers were excluded, since they were not relevant; 3 papers were excluded because either the full text was not available or they were not available in English; 7 publications were included in the present opinion.

References from RIVM report 2014: 13 references were selected from this report. The search strategy used in this report was also repeated to get an update on the literature since 2014. This resulted in 179 publications. Based on title, 7 publications were selected. Based on abstract 4 publications were excluded since they were not relevant. 3 publications were used in the Opinion. One of them had also been identified in the search of the EC library and e-resources centre.