

WA POLICE ACADEMY COMMAND & LAND OPERATIONS UNIT

AIDS TO SURVIVAL

Twenty Fourth Edition [First Issued 1979]

July, 2004

This book is a Western Australia Police Academy Publication and is available free of charge to individuals from their local Police Station. Organisations or groups requiring larger quantities can access and download this publication from the Western Australia Police website –

<http://www.police.wa.gov.au/RecruitingandTheAcademy/pdf/aids22.pdf>

The book is offered as an ongoing service in the interest of community safety. The contents are not subject to copyright and there are no restrictions on copying in any form by interested individuals and groups.

In keeping with the mission of the Western Australia Police Service to work in partnership with the community to create a safer and more secure Western Australia by providing quality police services the Command & Land Operations Unit at the Western Australia Police Academy invite comments, affirmations and suggestions for possible inclusion in future editions in an endeavour to improve this publication. Comments may be forwarded to the Command & Land Operations Unit at the Western Australia Police Academy.

A copy of this publication has been deposited in the Australian National Library.

ISBN: 0-646-36303-4

Introduction

Aids To Survival is a Western Australia Police Academy publication initially written and compiled by Sergeant Bert O'Meagher APM, Officer In Charge, Command & Land Operations Unit at the Western Australia Police Academy in collaboration with First Class Constable Dennis Reid and Dr Ross Harvey, M.B, B.S. D.Obst. R.C.O.G. A.C.C.A.M.

The Command & Land Operations Unit was introduced to provide members of the Western Australia Police Service with the necessary knowledge and skills to carry out their duties in outback Western Australia and to enable them to co-ordinate or participate in emergency operations and advise on outback safety. In keeping with the WA Police Service mission to provide a safer and more secure Western Australia the unit is concerned with the education of interested community groups and individuals.

Originally the book was produced to provide members of the Western Australia Police Service with a locally produced source of reference for use in training and for dissemination to the public. To this end the book has proved to be extremely successful, this being the 24th edition with over 430,000 copies being distributed since its introduction in 1979. It is now available on the Internet under the WA Police Service website.

The book is required reading for several community groups, youth organisations, education institutions and industry trainers throughout Western Australia. Contents have been provided to Royal Flying Doctor Service WA] for inclusion in their publication, Safety & Survival Handbook.

A dedicated group of community minded individuals and organisations have contributed information and items over the years and their efforts and contributions are much appreciated. Contributors include - Peter Bindon, Vern Delgado, Arthur Connor, Graham Brammer, Ronele and Eric Gard, Richard Lushey, Ric Clifford, John Evans, The Duke of Edinburgh's Award [WA], The Royal Lifesaving Society [WA], St John Ambulance [WA], Red Cross [WA], Bureau Of Meteorology [WA], Australian Communications Authority and Sergeant Phil Ramsay [WA Police]. Diagrams were originally drawn by Western Australian Government Print Artists and updated as required.

Staff at the Western Australia Police Academy Command & Land Operations Unit who have contributed to the book include; Senior Constable Paul McKee, Senior Constable Ian Thomson, Senior Constable David Stark, Senior Constable Douglas Fleetwood, Senior Constable Glen Blackwell and Senior Constable Shaun Jackson.

Thanks are also extended to students of classes conducted by the Western Australia Police Academy Command & Land Operations Unit and members of the community of Western Australia who have provided valuable comment and feedback.

M.W. SHERVILL.
SUPERINTENDENT
PRINCIPAL
WESTERN AUSTRALIA POLICE ACADEMY.

June-04

Contents

CHAPTER 1	7
Safe Outback Travel	7
PRIOR PREPARATION & PLANNING	7
VEHICLE SELECTION	9
VEHICLE PREPARATION	9
VEHICLE AWARENESS	11
VEHICLE CHECK LIST	12
VEHICLE TOOL KITS	13
VEHICLE RECOVERY EQUIPMENT	13
OFF-ROAD DRIVING TIPS	14
OUTBACK TRAVEL CODE OF ETHICS	15
CHAPTER 2	16
Outback Survival.....	16
BASIC REQUIREMENTS FOR SURVIVAL	16
ACTIONS BY SURVIVORS	17
SURVIVAL PLANS	18
WAPS PERSONAL SURVIVAL KIT	20
WAPS VEHICLE/AIRCRAFT EMERGENCY PACK	20
Water	21
THE IMPORTANCE OF WATER TO SURVIVAL	21
TIME FRAME FOR SURVIVAL [TFFS].....	21
HOW FLUID IS LOST FROM THE BODY.....	21
WHEN TO CONSUME WATER IN A SURVIVAL SITUATION	21
METHODS OF WATER PROCUREMENT	22
WATER PURIFICATION	26
Shelter.....	27
TYPES OF SHELTERS	27
Warmth.....	30
FIRE LIGHTING WITHOUT MATCHES	30
Food.....	33
LIVING OFF THE LAND	33
THE FOOD PREFERENTIAL	33
SNARING ANIMALS	34
ANIMAL BUTCHERY	40
PREPARATION & COOKING OF GAME	40
PRESERVING MEAT	41
EDIBLE PLANTS.....	42
PLANTS TO AVOID.....	42
THE ‘TASTE TEST’ FOR PLANT EDIBILITY	42
SOME COMMON TYPES OF EDIBLE VEGETATION	43
EDIBLE INSECT ACTIVITY ON PLANTS	45
CHAPTER 3	46
Direction Finding.....	46
WATCH METHOD	46
TRADITIONAL BUSHMAN’S METHOD [KANGAROO WALLOWS]	46
HAND SPAN METHOD	47
THE SHADOW STICK	47

AIDS TO SURVIVAL

THE SOUTHERN CROSS METHOD - AT NIGHT48
NAVIGATING AT NIGHT WITHOUT A COMPASS.....48

CHAPTER 4 49

Emergency Procedures 49

 PROCEDURE IF LOST.....49
 ELECTRONIC SAFETY AIDS.....50
 EMERGENCY SIGNALS50
 BUSHWALKING SAFETY52
 BUSHFIRE SURVIVAL53

CHAPTER 5 54

Radio Communications..... 54

 CITIZEN BAND RADIO54
 OPERATING PROCEDURES54
 EMERGENCY RADIO PROCEDURES56

CHAPTER 6 57

Creek & River Crossings..... 57

 APPRECIATIONS.....57
 METHODS OF CROSSING CREEKS & RIVERS58

CHAPTER 7 59

Bush First Aid..... 59

 CONDITIONS59
 BASIC LIFE SUPPORT60
 FRACTURES.....61
 FRACTURES OF THE SPINE.....61
 SPRAINS61
 HEAD INJURY.....62
 BURNS AND SCALDS.....62
 BLEEDING63
 PAIN.....63
 HYSTERIA63
 ASPHYXIA.....63
 INSECT BITES.....64
 SNAKE BITE.....64
 CUTS AND ABRASIONS65
 BLISTERS65
 SPLINTERS65
 CARE OF FEET.....65
 CASUALTY ACTION65
 HYPOTHERMIA.....66
 FROST BITE.....66
 HYPERTHERMIA.....67
 SALT DEPLETION67
 WAPA TEAM FIELD FIRST AID KIT68
 WAPA FIELD HEADQUARTERS BASE FIRST AID KIT.....68
 ST JOHN AMBULANCE HIKERS FIRST AID PACK.....69
 RED CROSS HIKING FIRST AID KIT69
 ACTIVITY-SPECIFIC FIRST AID KITS.....69
 DEALING WITH DEATH70

CHAPTER 8	71
Land Navigation	71
MAP READING	71
TERMS USED IN MAP READING	73
NAVIGATION ROUTE PLAN	74
WAPA NAVIGATION ROUTE PLAN CARD	75
GRID REFERENCES	76
MEASURING DISTANCES ON A MAP	77
THE POINTS OF A COMPASS	77
NORTH POINTS	78
The Orienteering Compass	79
MAGNETIC VARIATION	80
CONTOURS	81
DRAWING A SECTION	82
PREDICTING WALKING TIME	82
SETTING THE COMPASS TO WALK ON A MAGNETIC BEARING	82
TO TAKE A MAGNETIC BEARING	83
BACK BEARINGS	83
ALTERING DIRECTION TO AVOID AN OBSTACLE	83
COMPASS ERRORS	83
COMPASS RESECTIONS	84
Global Positioning Systems	84
CHAPTER 9	85
Expedition Skills & Campcraft	85
THE ROLE OF EXPEDITIONS	85
EXPEDITION LEADERSHIP	85
PRE-WALK CONSIDERATIONS	86
THE EXPEDITION PLANNING PROCESS	87
BRIEFINGS	87
EXPEDITION PLANS	87
DE-BRIEFINGS	88
PRACTICAL BUSHWALKING	89
JOURNAL WRITING	90
SAFETY CONSIDERATIONS	90
PRINCIPLES OF MINIMUM IMPACT CAMPING	91
FOOD AND COOKING	92
WAPA RATION PACK – 8 HOUR FOR 1 PERSON	94
WAPA RATION PACK - 24 HOUR FOR 1 PERSON	95
RECREATIONAL 2 – DAY RATION PACK FOR 1 PERSON	96
CLOTHING AND EQUIPMENT	97
PERSONAL & EMERGENCY EQUIPMENT	99
INDIVIDUAL CAMPING EQUIPMENT	100
GROUP CAMPING EQUIPMENT	102
EXPEDITION EQUIPMENT CHECK LIST	104
PACKING AND LOAD CARRYING	104
CAMPCRAFT	105
HYGIENE	106
WEATHER CONSIDERATIONS	106
WEATHER PATTERNS IN WESTERN AUSTRALIA	107

Safe Outback Travel

Adequate preparation before undertaking a journey or accepting employment in the outback will lessen the chance of jeopardising human life. There have been many cases where loss of life has resulted from a lack of foresight into the problems involved. The WA Police Service in it's mission to create a safer and more secure Western Australia provides a service which is responsive to community needs and is willing to act as a first point of call for safe outback travel. Members of the public are encouraged to discuss their trip plans and post notifications with local police.

PRIOR PREPARATION & PLANNING

There are a number of things to be considered before starting to pack for your trip, these are known colloquially as the 'Rule of P' and are linked to the premise that -

Prior Preparation and Planning Prevents Poor Performance.

Equipment Required

The equipment you are taking must be serviceable and sufficient for the trip. Allow additional equipment if in doubt. Maps should cover the entire area of the trip.

Radio Communications

For close range communication between vehicles a citizen band UHF or VHF radio may be used, however for long-range radio communication a HF radio is essential, these can be hired from communications suppliers at reasonable rates. Whilst travelling in the outback it is good practice to set up a communication schedule with the Royal Flying Doctor Service and contact them daily advising them who you are and where you are.

Satellite/Digital Telephone Communications

It is now possible to ensure telephone communications in the outback with the introduction of a system of digital telephones that allow the user to call on his/her digital phone and be connected automatically to a satellite system with no time delay if in an area not covered by a digital network. This system has a saturation system of satellites that download to ground stations and ensure instantaneous voice communication with no time delay between sending and receiving.

Terrain to be covered

A map study should be done to ascertain –

- Whether it is accessible by vehicle
- Where the fuel and water sources are located
- What is the best route
- What alternate route could you use if necessary
- What aids to navigation will you have
- What positions of evacuation are available
- Where are the local inhabitants

Use of Maps

The Western Australian bush is very monotonous with very few landmarks and a lack of signposts on outback roads. Be wary of spoken directions as they can be misinterpreted and the wrong track easily taken. In the absence of an official map, try to obtain a rough map drawn on paper with as many landmarks as possible indicated showing the necessary distances. Mark your position on the map as you proceed so you can pinpoint your location at any given time. Do confirm your position at every opportunity.

Weather Conditions

The weather must be considered as many road conditions vary according to the local rainfall. You should be aware of the changes of season in the area of your trip, this will ensure that you are going at the best time of year. Check with police or local authorities after rain as many outback roads can be closed.

Time allowance

You should consider carefully the time and space you are allowing for your trip.

Considerations should include -

- When are you leaving?
- How long will it take?
- Where do you propose stopping to camp?
- When will you arrive?
- Have you allowed a safety margin in case of minor mishaps?

Learn about the country

You should learn as much about the country you are to travel, as possible. This will assist you if you have to survive in it.

Things to study would be –

- Dangerous animals and reptiles
- Insects, flies and mosquitoes
- Prickle bushes and any poisonous or discomfiting plants
- Any edible wild foods and bush tucker
- Available water sources
- Caves, mine-workings, holes and local problems
- Diseases to guard against

Notifications

Before leaving on a journey through remote areas always notify a responsible adult in the form of friends, relatives, station owners or police of the following information –

1. Estimated time of departure [ETD]
2. Proposed and alternate routes
3. Estimated time of arrival [ETA]

Note:

Don't forget to notify those concerned once you have safely completed the journey.

VEHICLE SELECTION

Selection of a suitable vehicle for safe outback travel will rely on the load that you are going to carry.

As well as major items of fuel, food and water you may also be carrying camping equipment, cooking gear, vehicle spares, tools, recovery equipment, an extra spare tyre and passengers.

If you choose to travel 'off road' you will need to be sure your vehicle can withstand the harsh and rugged conditions you will encounter.

VEHICLE PREPARATION

Your vehicle will not only be your means of transport but if you are travelling 'off road' it will be your home and of course your biggest aid to survival should something unforeseen happen to you. As such it must be in first class mechanical condition.

If you are not a mechanic it is best to take the vehicle to one who specialises in this type of vehicle. Explain the nature of your trip and have them go over the vehicle from top to bottom. Short courses in vehicle maintenance are offered by most community, TAFE Colleges, etc.

Roof Racks

To carry the intended load you will probably need to install a roof rack. Buy only from a reputable manufacturer who specialises in your type of vehicle.

Under Body Protection Plates

These are considered necessary by some people for rocky creek crossings, etc. They can be a problem in spinifex country as after only a few kilometres' spinifex packs tightly under the plate and creates a definite fire hazard.

Roos and Scrub Bars

These are not essential items for off-road travel but they can be good value should you be unlucky enough to hit a kangaroo or other large animal.

Spinifex Protection

Some spinifex grows to a height of nearly 2m and the seeds can be drawn into the radiator. At least 3 layers of fibreglass wire netting should be placed over the front of the vehicle.

Fire Extinguishers

It is good planning to carry at least 5 litres of water in a plastic garden spray for spinifex and grass fires as well as an extinguisher suitable for electrical or fuel fires.

Tyres

It is important to discuss your tyres with your local tyre dealer before your trip. Ensure you have the right tyres for the task. Eight ply radials are recommended as a minimum for off-road use. Two spares plus an additional 2 tubes should be carried.

Wheel Rims

It is easier to change a tyre on a split rim than on a pressed safety rim or alloy rim so stick with the standard steel split rim if possible otherwise a specially designed bead-breaker should be carried for removing tyres from rims and replacing them.

Recovery Equipment

A valuable accessory for getting out of bogs is the exhaust jack. This is a blow-up heavy duty rubber/canvas bag, which is placed under the vehicle and inflated by connecting it to the exhaust pipe with the engine running. Its purpose is to jack up the vehicle on any surface.

Winches

Types of winches range from hand, electric or power take off. If you have a winch fitted to your vehicle make sure you know how to use it. Some simple safety rules include -

- Always use a sling around an anchor point rather than forming a loop.
- Never place your hands within 1m of the drum if the winch is operating.
- Always leave six turns of cable on the drum.
- Run the engine when using an electric winch.
- Do not pull if the cable is more than 15° to either side.

Dual Battery Systems

When operating in the outback each battery should be used individually on a daily basis. When making camp for the night the appropriate drill should be used to ensure that the alternate battery is fully charged and will start the vehicle in the morning. The battery used for overnight use [refrigerator, etc.] may go flat.

Fuel

Long-range fuel tanks are an excellent idea but make sure yours is fitted in the approximate centre of the vehicle between the chassis rails. Use the rear tank first to equalise load. If you do not have a long-range tank then 20 litre jerry cans are an excellent method of carrying fuel. If you carry jerry cans make sure they are metal or designed to carry fuel and use tie wire on all caps to prevent spillage.

Water

Allow 4 to 5 litres of drinking water for each person per day while travelling. If you have a built in water tank fitted with an external tap it should be fitted with a tap guard and the tap itself lock-wired when moving.

Emergency Pack

Enough spare food, water and blankets should be included to allow for any unforeseen delays. Emergency rations should last at least three days on top of your planned trip. A three-day emergency pack for each person should consist of –

- 6 ready-to-eat meals in cans [or other]
- 4 litres of water
- Foil emergency blanket

Vehicle Loading

The loading of the vehicle is critical and the vehicle's centre of gravity kept as low as possible always. Get in the habit of checking whenever you stop.

VEHICLE AWARENESS

The development of electronic [computer] engine management systems for modern diesel engines has forced a change in the way diesel 4WD owners operate their vehicles. The reservations a lot of people had with the development of computer engine management systems in petrol-powered 4WD vehicles in the early 90's were in most cases largely unfounded. What was required then and now with the modern diesel is driver education.

Gone are the days when all a diesel 4WD owner had to worry about with a water crossing was keeping the air intake out of the water. In effect these new generation 4WD diesels, because of the electronics, have to be treated like petrol-powered vehicles. Contact your local dealer or 4WD service centre and have them point out the location of the vulnerable points [electronic] under the bonnet of the vehicle.

Remember a clean engine is less likely to short out. To prevent condensation [a problem for any electrics] clean the engine bay when the engine is cold with low-pressure cold water.

Once these vulnerable or sensitive components are located suitable precautions can be taken. The location of the main computer is usually under the seats or behind the front left or right inside kick panels, near your feet.

A word of caution with these computer managed 4WD's for those who traditionally fit their own radios and other electrical accessories. Finding the nearest live wire or earth and connecting to it is fraught with danger. If the pick-up wire is part of the computer management hardware that carries signals and mixed voltages you could unknowingly cause expensive irreparable damage.

Note:

To prevent damage have any electrical accessories fitted by a professional.

Jump-starting is no longer a matter of connecting any set of jumper leads between vehicles. Your leads should have a surge protector fitted to prevent a possible voltage spike, which will damage most computers.

Most 4WD vehicles with computer management systems will have an emergency limp home mode that comes into play when the engine management system has been adversely affected. Although the extent of operation will vary from vehicle to vehicle road speed will be limited and cruise control, traction control and other non-vital functions will be disabled. Visually, a dashboard-warning icon will be displayed telling you which system has been disabled.

The benefits gained from computer engine management systems for diesels such as more power, better fuel economy and lower fuel emissions should not be jeopardised by a driver's level of ability or lack of knowledge and understanding of the vehicles systems and components.

Note:

As a new owner you should take the time to study the owners manual and consult with your dealer or 4WD service centre before you venture off road.

VEHICLE CHECK LIST

The following items should be checked at the end of each day. This procedure should be conducted as part of your everyday routine and should never be neglected.

1. Check engine drive belts
2. Check engine oil levels
3. Check coolant levels
4. Check fuel filter [if possible]
5. Clean air cleaner
6. Clean radiator fins
7. Check brake fluid levels
8. Check clutch fluid levels
9. Check power steering fluid level
10. Check engine for oil leaks
11. Check engine for coolant leaks
12. Check transmission for oil leaks
13. Check differential for oil leaks
14. Check all steering rods for wear and cracking
15. Check all joints for wear and cracking
16. Check all tyre pressures
17. Check all tyres for damage
18. Check battery levels
19. Check chassis rails for cracks
20. Tighten all mounting bolts, etc.

VEHICLE TOOL KITS

A comprehensive tool kit should be carried and should be suited specifically to your vehicle. Suggested items include -

Vehicle Tool Kit

Screwdriver, 200mm	Oil Filter
Screwdriver, Phillips	Insulating tape, roll
Pliers, general purpose	Alligator clips, electrical
Pliers, long nose	Electrical wire, roll 3mm
Spanner, adjustable 200mm	Tyre levers and wheel brace
Tyre pressure gauge	Wheel brace
Set metric spanners and sockets	Feeler gauges, set *
Small hammer, hacksaw and blades	Fan belt and Power steering belt
Spark plug socket *	Contact points* and Spark plugs*
Set of radiator and heater hoses	Jumper leads
Tyre pump, hand or foot operated	Grease, 500gms and Epoxy resin
Condenser and Coil *	Fuel filter
Funnel	Masking tape
Can of aerosol de-wetting agent	Rubber vulcanising tape
Brake fluid, 500ml	Plastic tubing, 8mm
Engine oil, 5L and Gear oil, 500ml	Paint brush
Trouble light	Magnet
Araldite fixative	Electrical fuses, set
Bead-breaker & tyre re-fitting tool	

Note:

* Diesel vehicles do not require these items.

VEHICLE RECOVERY EQUIPMENT

If you travel in the outback "off road" at some stage you are going to encounter sand dunes, claypans, salt lakes and rocky creek beds. You are eventually going to become stuck and a complete vehicle recovery kit should be carried.

Vehicle Recovery Kit

Recovery equipment carry bag. Ground sheet. Leather gloves. Long handled and short handled shovels. Axe [medium size]. Winch [hand or fully fitted electric]. Snatch strap 9m based on 4WD size 8,000kg – 11,000kg – 15,000kg. Tree trunk protector 3m [12,000kg]. Recovery bridle. Drag chain 8mm diameter, 5m long [8,500kg]. Bow shackle 2.35T. Bow shackle 4.75T. Marlin spike. Snatch block. Centre pull recovery adaptor for fitting to tow bar. Vehicle jack with base plate [300x300 recessed marine ply]. Hi-lift jack [remember to fit jack lift points]. Air jack [Bull bag]. Air compressor.

OFF-ROAD DRIVING TIPS

Whether you intend travelling to the Pilbara, the Kimberly or out to the Bight the locations may be vastly different but the off road driving principles remain the same. Your trip can be safer and free from costly damage to your vehicle by following these driving tips -

- First of all find out the overhang distance of your vehicle. This is the distance from the front of your vehicle to the first point you see on the road in front of the vehicle. The point in front of the vehicle is calculated with you seated normally in the drivers seat. You will be surprised at how far this overhang distance extends to the front.
- As the road is constantly changing you must learn to search ground quickly and make decisions on wheel placement early.
- Lower your radio aerial to prevent damage or fit one with a spring base.
- Search the ground in a rectangular pattern looking from the front as far out as possible on the drivers-side wheel track and then back in towards the vehicle along the passenger-side wheel track.
- Identify and avoid any object that can damage the tyres or under-body components of the vehicle such as stumps, sharp rocks, or deep potholes. At times it may be better to drive a wheel over a large rock rather than have the vehicle straddle it. By doing this you raise the vehicle's differential ground clearance and you prevent possible under body damage by hitting rocks. Assist with this by learning the location of the front and rear differentials in relation to where you as the driver sit.
- Remember where applicable to lock your free wheeling hubs or central differential.
- It is a good idea to lower your tyre pressure to around 80% of your highway running pressure. This will give the tyres a little more flex and grip to mould over rocks and loose gravel rather than causing the wheels to spin and lose traction, which would occur if the tyres were left at the hard highway running pressure.
- When driving in soft or sandy conditions the lowering of tyre pressures can prevent bogging. Tyres can be lowered to a minimum pressure of 16psi in both split and safety rims. Tyres must be re-inflated immediately after traversing the obstacle, failure to do so will lead to tyre damage.
- Where you are going up or down a steep hill always engage low range on the transfer case. For those vehicles that don't have a low range capability be very careful to assess the terrain so that you may safely negotiate it.
- For those auto transmission 4WD vehicles select low range and lock the gear lever in low gear whenever descending a steep off-road track.
- Drivers of manual 4WD vehicles should remember that depressing or riding the clutch off-road is fraught with danger.
- If you stall or stop the vehicle on a descent you can restart in low range with the vehicle in gear. Simply turn the key on and do not depress the clutch. Cover the brake pedal and be ready to apply brake pressure if the vehicle surges forward [common with fuel-injected vehicles]. This ensures you are under control at all times with the engine running and gears engaged. Don't ride the brakes but feather them as required to slow the rate of descent.

OUTBACK TRAVEL CODE OF ETHICS

Outback travellers should consider themselves caretakers of the land and ensure that their actions do not add to the degradation of the landscape.

- Do make sure your vehicle is in sound mechanical condition and equipped with all necessary fuel, food, water and spares needed to complete the journey.
- Do have the ability to communicate with the outside world either by radio, satellite phone or global positioning system e-mail.
- Do tell someone of your intentions. Notification of your time of departure, intended route, campsites and estimated time of arrival at your destination may be posted at local police stations.
- Do camp in designated campsites or in natural clearings if none are available.
- Do observe fire restrictions, clear around fire areas and extinguish all fires.
- Don't break or cut live branches from trees and shrubs for fires or campsites.
- Don't leave garbage in the bush. Carry garbage bags with you and remove your waste.
- Do stay on existing tracks and endeavour not to create new tracks or short cuts.
- Do clear fallen trees or logs if possible rather than driving around them.
- Don't camp near stock troughs or in water catchments.
- Do carry maps, information on terrain, track and weather conditions, navigation equipment and set escape routes.
- Don't travel off-road at night. If you must travel at night use only 50% of the speed you would use during the day and do not attempt rocky ground, mud patches or deep water crossings.
- Do know your vehicle controls so you know where they are in an emergency.
- Do know the length and width of your vehicle for negotiating difficult terrain.
- Don't infringe on the privacy of aboriginal people or any settlement and be aware that permission must be obtained to cross aboriginal reserves and communities.
- Don't carry firearms on pastoral leases without permission from the lessees.
- Travellers from outside Western Australia must obtain a temporary firearms permit from the nearest Police Station on entering the state.

Outback Survival

While the chance of the average individual becoming lost or stranded in Western Australia is remote, there are people every year who find themselves in unexpected outback survival situations where they are forced to battle the elements to survive.

For some, who are fitter than most and having sufficient strength of purpose and possessing the propensity for making the best of a poor situation, the task will be a lot easier. The majority of the general public unfortunately are not gifted in this way.

Survival Defined

Survival is defined as staying alive and in the outback is a day-to-day proposition with each day being broken into two parts, day and night.

The First Rule Of Survival

The first rule of survival is 'don't panic'.

The Survival Mnemonic

The word 'survival' is an aid to what you should do. You must memorize what each letter signifies and remember that some day you may have to make it work for you. It is a good tool for helping you focus and avoid immediate panic.

- S** Size up the situation
- U** Undue haste makes waste
- R** Remember where you are
- V** Vanquish fear and panic
- I** Improvise
- V** Value living
- A** Act like the locals
- L** Lean on your basic skills

BASIC REQUIREMENTS FOR SURVIVAL

There are four basic requirements for survival; they are –

1. Water	2. Shelter	3. Warmth	4. Food
----------	------------	-----------	---------

Generally the priorities will be as listed, however, in some situations you may alter them to suit; for instance shelter may be number one priority if water is available.

Prior Planning and Preparation

Adequate preparation before undertaking an outback journey or outdoor activity will lessen the chance of jeopardising human life. Unfortunately there have been too many cases where loss of life has resulted from a lack of foresight into the problems involved.

If you have advised someone where you are going and how long you intend to stay a search will no doubt be conducted for you if you are overdue. Your task will be to use the knowledge and skills you have to stay alive until found.

The Rule of 'P'

Prior planning and preparation prevents poor performance
--

ACTIONS BY SURVIVORS

While a survival situation will be a traumatic experience for most people the effect it will have will depend on circumstance. For instance a person suffering a vehicle breakdown in spring in the southwest of Western Australia will have a different reaction to a person who suffers a similar breakdown in mid-summer in the Great Sandy Desert.

Stress and Survivors

Stress is defined simply as ‘reaction to pressure’. Unforeseen events or overload situations that arise can put a strain on our ability to cope and make us feel out of control. It is this feeling of not being in charge of a particular situation that we label as stress.

Stressors

Stressors are events that cause stress, the most common to survival include heat, cold, thirst, hunger, fatigue, isolation, fear, uncertainty, lack of control, injury, illness and death.

Reactions To Stress

There are natural reactions to stress that need to be recognised, expected and for which strategic interventions need to be implemented. Signs that indicate stress include –

Fear Anxiety Guilt Anger Panic Aggression Depression

Do not over-react and remember, too much stress leads to ‘distress’ resulting in anti social behaviour, angry outbursts, difficulty making decisions, unwillingness to accept responsibility, inability to get on with others and eventual withdrawal from the group.

Coping With Stress

In order to cope with stress, you must; keep your emotions in check, stay as physically relaxed as possible, take constructive action and use common sense.

Initial Critical Reactions In Unexpected Survival Situations



- S Stop:** Calm down, keep your emotions in check, recognise that you are in a survival situation, adopt a positive attitude and remember that your life and the lives of others who are relying on you to do your share are at stake.
- T Take stock of your situation:** Stay physically as relaxed as possible and ask yourself; how much water do you have and how will you procure more, what shelter from the elements is needed, will you need a fire, how much food do you have and what is available?
- O Organise your thinking:** Get your thoughts on track and take constructive action by employing the survival mnemonic, recognise any survival stressors that are present and overcome any attitude assumptions [*She’ll be right. It will never happen to me. If anything does happen my instinct, faith and/or inner strength will get me through, etc*].
- P Plan for your survival:** Make an honest appraisal of the situation, use common sense and remember that your physical strength and emotional resources are strongest in the first three days of survival.

Survival Situation Appreciations

The six elements to a survival situation appreciation are –

1	2	3	4	5	6
Review the situation	Determine your aim	List the factors affecting your survival	Identify all courses open to you	Select the best course of action	Make a plan

SURVIVAL PLANS

The Survival Plan is the final process by which you or the group have chosen to stay alive. It is the final result of your appreciation and should be based on the facts at hand that have been subject to thorough and systematic thought and/or discussion. It needs to be prepared in a systematic way and re-examined regularly. It must be accurate, brief but clear, contain all necessary information and most importantly be capable of being carried out.

Layout of survival plans

Plans need to follow a logical sequence to ensure all aspects are covered. The five headings covered by the plan should include –

- S** Situation
- M** Mission
- E** Execution
- A** Administration & Logistics
- C** Command & Communications

SITUATION [brief description of what has happened]

This is a brief description of factors known and assumed from what has happened and should include the following details -

Human resources

What skills are available within the group? Does anyone have any survival knowledge? Is there anybody in the group with professional or specific capabilities? Does anyone have any disabilities or limiting health conditions?

Water

What water do you have? Is it likely to rain? Is there any water available in the area? What equipment do you have for storing water, carrying water and water procurement?

Shelter

What prevailing conditions do you need to shelter from? What can be improvised to provide shelter? What items do you have that can be used to build shelters?

Warmth

Do you have matches or a cigarette lighter? Can you identify any alternative methods of lighting fires? Can you gather enough fuel to sustain warmth for a period of days?

Food

What food do you have? Is there any food available in the area? What equipment do you have for hunting, gathering and storing food?

Location

What is your present general location?

Direction

Can you indicate north, south, east and west?

Rescue

How do you expect to be rescued? What direction do you expect rescue to come from? How will you signal rescuers? What is available to build rescue signals?

Equipment

What equipment do you have and what can be improvised?

MISSION [overall objective of what you hope to achieve]

A clear, concise, single purpose statement of the overall outcome to be achieved. In all survival situations the mission statement is - *To Stay Alive*.

EXECUTION [what you are going to do in order to achieve the mission]

Should contain details of your best course of action and how the mission will be accomplished. It must include a general outline together with details of roles, tasks, methods, boundaries and special equipment. If possible people in a survival situation should remain with their vehicle or aircraft and if on foot establish a camp as soon as practicable. If in a group task leaders should be elected and teams nominated for each of the following requirements -

Water

Develop a control and distribution plan for any available water and discuss and implement water procurement strategies and methods to be used.

Shelter

Conduct an audit of useable items available; nominate a shelter-building team to determine the type of shelter or shelters required and methods of construction.

Warmth

Identify ways of staying warm and develop strategies and procedures to cope. Nominate a team responsible for gathering fuel, identifying any available accelerants and identify suitable fire lighting methods.

Food

Develop a control and rationing plan of available food and discuss and implement food procurement strategies and methods.

Direction

Locate north and construct an earth compass.

Location

Locate your position relative to identifiable landmarks and easily recognisable features and set boundaries for movement outside the camp area.

Rescue Signals

If in a group elect a task leader, develop rescue strategies, build and maintain rescue signals and implement the 24 hour manning of fires and emergency signals.

Co-ordinating Instructions

Details common to all members of the group providing a standard by which elected leaders can maintain control and group members maintain focus. They include details of timings, movement, navigation and actions-on for injuries, lost persons and death[s].

ADMINISTRATION & LOGISTICS [what is needed and what is available]

Details of food and water available with distribution and consumption arrangements along with dress standards and equipment requirements should be detailed.

COMMAND & COMMUNICATIONS [who is in charge and details of signalling]

If in a group the elected group leader and those in charge of the various tasks must be known and agreed to by all. The agenda for group meetings should be set along with timings for task completion. Those responsible for manning emergency signals and fires should be nominated.

WAPS PERSONAL SURVIVAL KIT

These personal survival kits have been designed to assist in managing unexpected survival situations in remote areas by ensuring that survivors have the means to provide the four basic requirements for survival. They come in a compact hip-belt pack and should be carried with you at all times when away from your base camp or vehicle.

Some thought should be given to selecting items normally carried to allow for future improvisation; bootlaces and hat bands can be replaced with cord, neck scarves with netting, watches worn, compasses placed on key rings, matches and a whistle carried.

Survival Kit Contents

- Survival kit with belt - Can be used for first-aid slings, carrying items and shelters.
- Water bottle – Flexible with a capacity of 1 litre, filled with drinking water.
- Water bottle cover – Clarifying filter, carry bag.
- Survival Knife – Lightweight, double-edge blade with spear point suitable for cutting, slicing, skinning, hacking, chopping, digging and grinding.
- Plastic bags - Ground sheet, raincoat, shelters, carry bags and water collection.
- Foil rescue blanket - Shelter, warmth, water collection and signalling aid
- Nylon cord - Shelter building, weapons, traps and snares.
- Fishing gear - Fishing, shelters, traps and snares.
- Elastic rubber tubing - Slingshot, gidgee, drinking straw, traps and snares
- Canvas tape - First aid, shelter building and repairs to gear.
- Netting - Fishing, traps and snares, carry bag.
- Alfoil – Cooking, water collection, containers and for distillation.
- Signalling mirror – Lightweight, small, strong, signalling aid.
- Magnetic compass – Direction finding.
- Waterproof matches / Disposable lighter - Fire-lighting and signalling.
- Water purifying tablets - Water purification.
- Barley sugar - Energy food source.
- Notepaper and pencil - Keep diary, record plan and write messages.

WAPS VEHICLE/AIRCRAFT EMERGENCY PACK

This emergency pack is designed to provide each person with the basic requirements for survival for the three-day period following a vehicle breakdown or air emergency. There should be one pack carried for each person. It should be carried in your vehicle or aircraft at all times and it must be easy to access in the event of an emergency.

Emergency Pack [per person]

- Water bottles rigid or collapsible - Complete with 4 litres of drinking water.
- Foil rescue blanket - Shelter, warmth, water collection and signalling aid.
- Food - 6 ready-to-eat meals in cans, bars [or other].

Water

THE IMPORTANCE OF WATER TO SURVIVAL

In Western Australia, people do die after becoming lost or having their vehicle break down in the remote and arid areas of the state.

In the past twenty years, 44 people have perished in WA due to excessive heat, thirst and exposure. Many of these deaths occurred because of poor survival techniques. The average person can expect to survive without water for 2-5½ days depending on the climate and what they try to do. Some individuals have perished within hours of becoming lost.

You must conserve any water you have, including that in your body. Water is required to replace fluid that is lost, so by conserving body fluid you will require less water intake. Reduce your food intake until your water supply is assured, as fluid is needed to digest food.

TIME FRAME FOR SURVIVAL [TFFS]

Research has indicated there have been cases where in ambient temperatures of 37°C and above, survivors have stayed in the shade at all times, followed good survival principles and survived for the following periods when in possession of the nominated amount of water.

No water	1 litre	2 litres	4 litres	10 litres
2-5½ days	6 days	6½ days	7½ days	11½ days

HOW FLUID IS LOST FROM THE BODY

Fluid is lost from the body by perspiring, breathing, urinating, vomiting, crying and talking.

Perspiring

Perspiration is a mixture of salt and water with the amount of salt varying from person to person. It is a normal bodily process that has a cooling effect as moisture evaporates from the skin surface. A person resting in the shade when the temperature is 35°C would lose about 2 litres of fluid in a 24-hour period. It is important to keep activity down to a minimum and conserve existing body fluids as any rise in body temperature can see losses in excess of 1 litre of fluid per hour resulting in dehydration.

Urinating

Is also a normal bodily process and cannot be prevented. However, it should be held as long as possible to slow down this fluid loss from the body. On no account drink urine unless it has been distilled. You could apply it to the skin surface with a sponge, in the hope that it will reduce your body temperature.

Vomiting

Can generally be avoided by leaving bad or harmful food well alone.

Crying

Should also be avoided, but it may be difficult to convince a child of this.

WHEN TO CONSUME WATER IN A SURVIVAL SITUATION

You should always drink to replace fluids lost from your body, however if you are unable to locate or procure water and are limited to the water in your survival kit it should be consumed in small sips to replace some of the fluid lost to your system. This one litre of water will increase your time frame for survival by up to half a day.

METHODS OF WATER PROCUREMENT

Your first efforts in a survival situation should be directed towards establishing a good water supply. Initially you should look for ground water using the following methods.

Creek beds

Are easily discernible in dry areas because of the relatively green vegetation and taller trees following the course of the creek. Unless there has been recent rain in the area the creek bed will probably be quite dry. You may be lucky enough to locate damp sand or mud at the bends of the creek or by digging in the creek bed at a likely spot. Water can be extracted from the damp sand or mud by soaking a rag in soil and wringing out the water into a container.

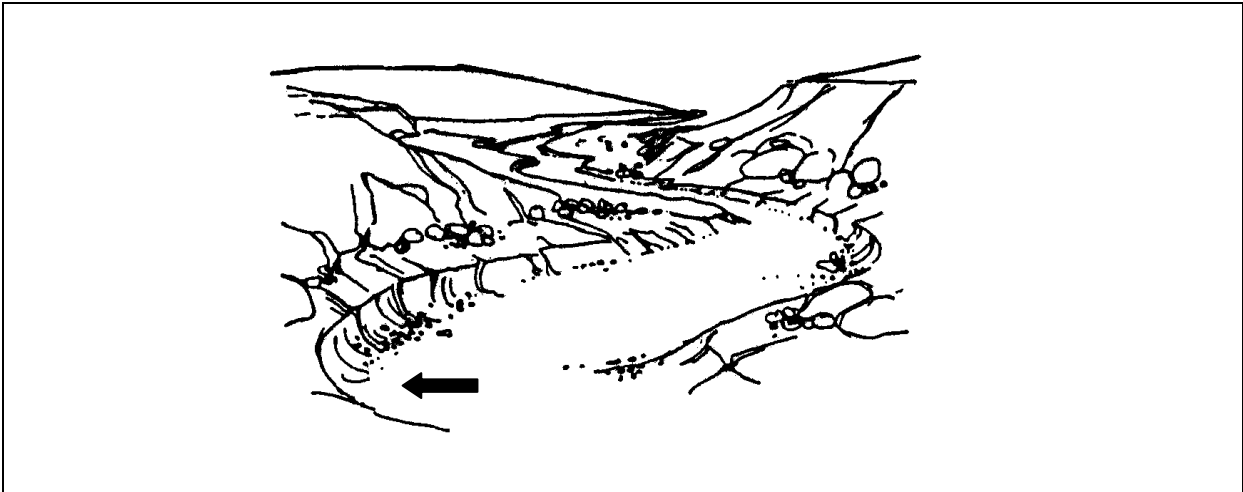

Where To Dig In Creek Beds For Water

Rock Formations

If there is any water seepage from the ground, it is usually to be found near rock formations, where the country is rugged and undulating. It may also be found in some apparently dry areas. Rocky areas are ideal for rain catchments. Rain soaks very quickly into the soil, whereas it can lie in pools on a rocky surface for some time.

Salt Lakes

After rain has fallen, the top 3mm of a salt lake is fresh water. It can be siphoned off by using a grass straw or tubing from your survival kit.

Windmills

These have been erected on most farms and stations throughout the state at such locations as wells, dams and soaks. These can be seen from a long distance and usually have animal tracks leading to them. Check the water at these mills has not gone salty.

Animal Trails

Animals need water the same as humans and they will travel great distances regularly each day, leaving trails to the water source. Where a large number of trails converge together, it would indicate that the water was not far distant.

Water seepage

Sometimes water can be found close to the surface in natural springs and soaks or at the base of cliffs and rock-piles where vegetation appears to be thriving.

Tree Roots

In the early morning before the heat of the day, the roots from trees such as the boab, kurrajong, wattle and some gums can be cut into short lengths, stood end-on with their thickest ends down in a container allowing the fluid to drain. It is best to use roots that are easily obtained with a minimum of effort. The ideal location for this is in creek beds and washouts where parts of the roots are already exposed or near the surface. Remember that the roots from trees growing in gullies will contain more water than trees growing on hills.

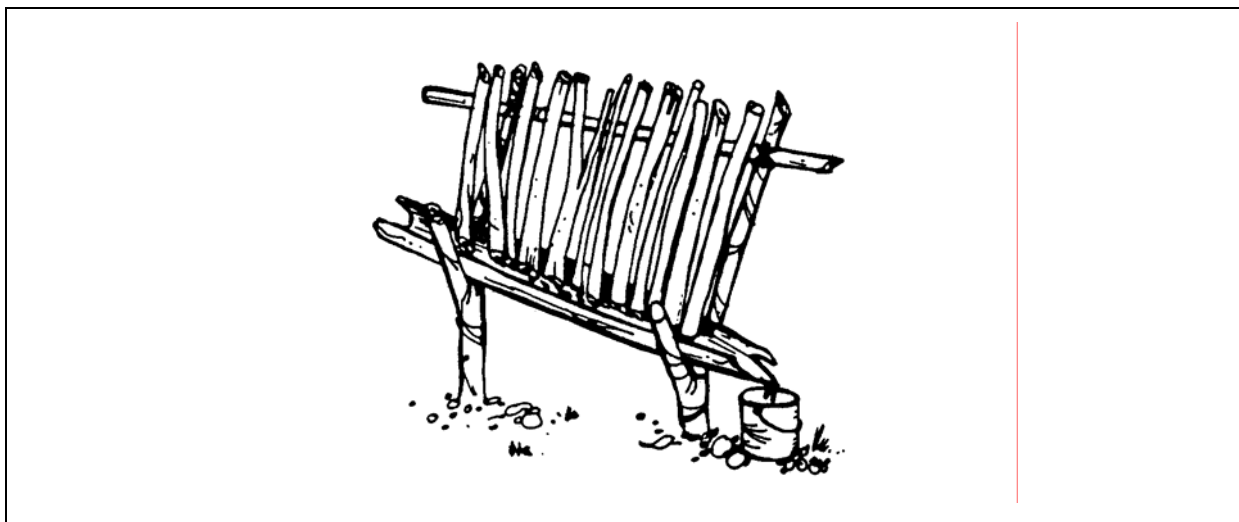

Draining Water From Tree Roots

Certain Trees

Some trees such as the boab, desert-oak, she-oak and paperbark store water. Water will collect in the crevices of some of these trees after rain, in blisters under the bark in others such as the paperbark and in the sapwood under the bark of the boab.

A length of rubber tubing can be used to siphon water from crevices and the water from blisters and under the bark of some trees can be extracted by cutting a 'V' through the bark and collecting the escaping water in a container.

Note:

Chewing the sapwood of trees is not recommended as it may aggravate thirst.

Coastal Water Sources

You can obtain drinking water by digging high up on the beach above the tidemark or behind the first sand hills. It tastes brackish and should only be used in small quantities.

Dew

The collection is tedious, but of some value in heavy grassland. Tie clumps of grass or cloth around ankles and walk around in dew-drenched grass at dusk or dawn. Squeeze moisture into a container and repeat. If you have a vehicle, wipe down the vehicle with a cloth and collect the dew in a container. You can also dig 'dew holes' and line them with plastic to collect the dew.

Foliage Bags

If there are no large trees in the area you can break up clumps of grass or small bushes and place them inside the bag, the same effect will take place as in transpiration. Make sure you follow the guidelines and provide a sump and remember to replace the foliage at regular intervals when water production is reduced.

Transpiration Method

Water can be obtained by placing a clear plastic bag over the leafy branch of a non-poisonous tree [you must 'taste-test' the foliage] and securing the bag with tape at the end of the branch. Seal any holes with tape, band-aids, etc. The action of the sun on the plastic will cause water to be drawn from the leaves and run to the lowest part of the bag. Do not disturb the bag to collect the water, simply cut a small hole in the bag then reseal it. The leaves will continue to produce water as the roots draw it from the ground.

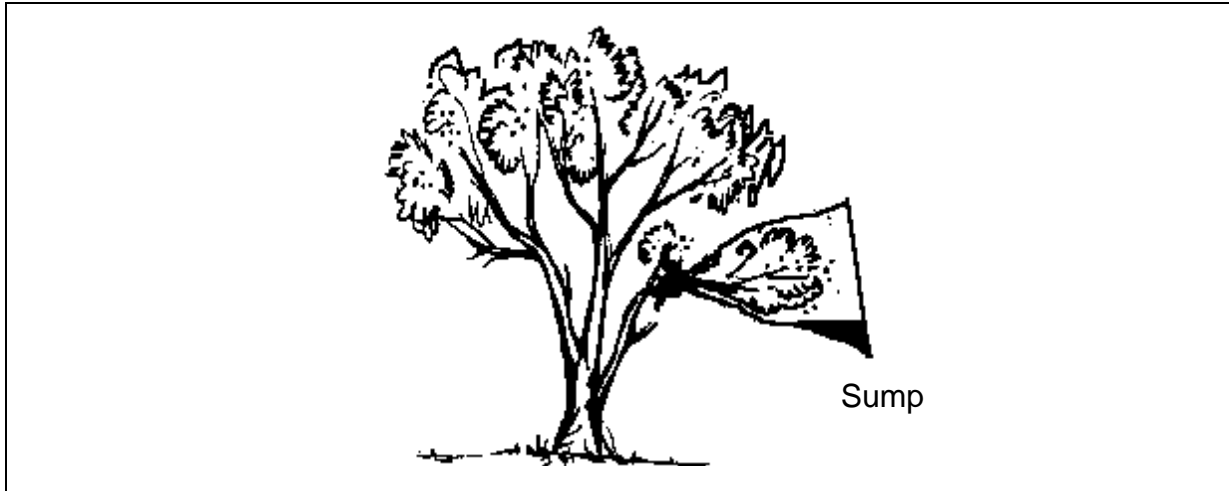

The Transpiration Method

The water should be drained off every two hours and stored. Tests indicate that if this is not done the leaves stop producing water. Probably the heavy concentration of moisture-laden air reduces the effectiveness of the sun. Ensure these bags receive maximum sunshine at all times. Exposed roots can be tested for water content prior to bagging the tree. Soft pulpy roots will yield the greatest amount of liquid for less effort.

Note:

A piece of cord can be tied around the bottom of the bag to form a sump and will stop sticks, leaves and insects from contaminating the water or blocking the tapping hole. It will also stop alkalines leaching from the foliage into the sump.

The Desert Still

Dig a hole approximately 1m x 1m x 60cm deep, line the hole with non-poisonous vegetation and place a container in the centre with a piece of rubber tubing leading from the container out of the hole for use as a drinking straw. Cover the hole with a clear plastic sheet and seal around the edges with soil from the hole. The plastic sheet should be weighted with a stone placed in the centre so it forms an inverted cone to allow condensed water to run into the centre on the underside of the plastic and drip into the container.

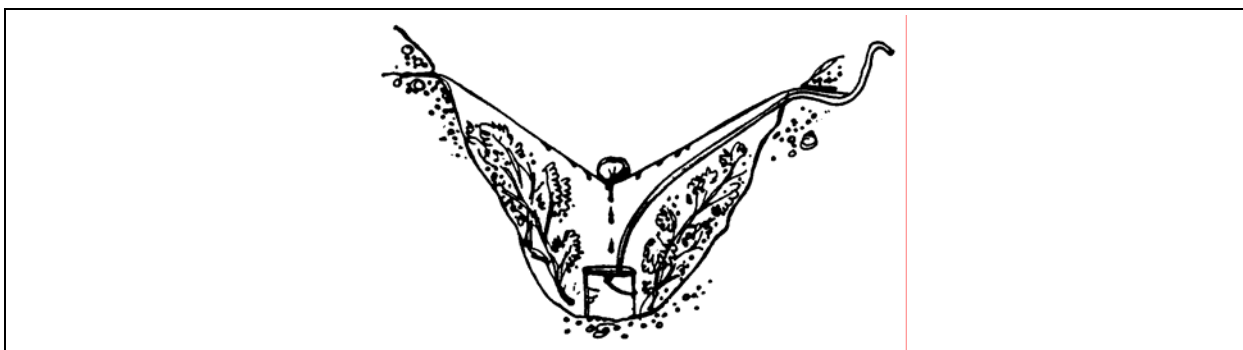

The Desert Still

The desert still method will work without the drinking straw, however to collect the water the edges of the plastic must be lifted allowing moisture-laden air to escape. The foliage will need to be replaced when water production falls off. Care should be taken that the plastic sheet does not touch the foliage as this will prevent the condensed water from running into the container. Additional fluid such as salt water from salt lakes, urine, etc. can be added to the hole.

Note:

This method while efficient has the disadvantage of requiring a lot of effort and subsequent loss of fluid from the body through perspiration and therefore is not recommended in areas where the transpiration bag can be used.

Distilling Sea Water

If only salt water is available a distilling plant can be made. You will have to improvise and use containers that can be found or that you may have. First you require a container of seawater and material to seal the container to prevent steam from escaping. Push one end of the tubing or rubber hose through this seal material and check to see that the seal remains intact while blowing into the loose end of the tubing. Place the container onto a fire and bring to the boil. Steam will be forced through the tube where it condenses and fresh water will drip from the end, into another container.

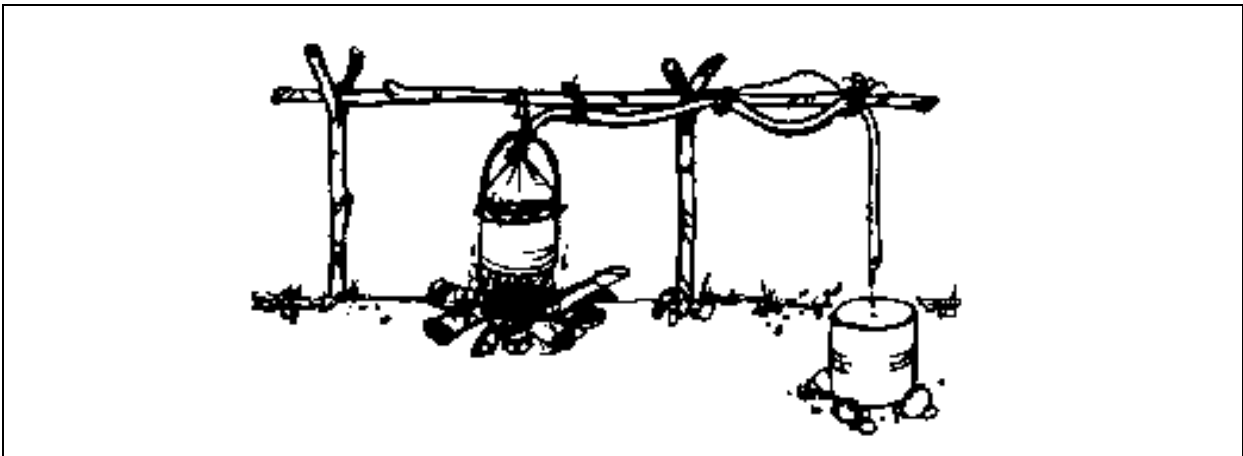

The Condensation Method Of Distilling Water

Another method is to simply bring water to the boil and catch as much steam as possible on a piece of cloth and then ring it out. Although this method works, it is not the most efficient.

You must remember that the steam is the fresh water and therefore you must trap the steam to get fresh water. Any improvised method will do even if you place an open container on the fire and bring it to the boil, and then arrange a small plastic 'tent' on top of it. The steam will strike the tent, condense and run down to your container or containers.

Note:

Alfoil or similar would make a seal around the container by folding it into a cone shape with the tubing attached to the small end of the cone and placing the large end around the container, secure ends of cone with wire to make the seal. Run the tubing through a cooling agent [water].

WATER PURIFICATION

You must always ensure that the water you drink will not cause internal infection as this will lead to further loss of fluid. You must purify any natural water that you drink by using a water filtration device, adding sterilization tablets such as Micropur Tablets or Puritabs, or by boiling it.

Note:

Salt water should never be drunk unless distilled.

Clarification of water

Drinking water should be as clear as possible. It can be left for twelve hours to settle or strained to remove suspended matter. One method of doing this is to use a canvas 'Mills Filter'.

An improvised filter can be made from the leg of a pair of trousers or a shirtsleeve. Into this place fine sand for one third of the filter, charcoal for the next third and fill to the top with gravel, small stones, etc. Hang the filter in a tree or similar and pour in the muddy water. It will take a little time but clarified water will seep through the filter and drip into a container placed underneath.

Note:

Remember that while more palatable, this water is not purified.

Sterilisation of water

Because the water is clear does not mean that it has no bacteria in it. To make sure of this you must sterilise any natural water that you drink. To sterilise water you can use several methods; the recommended method is to put in sterilisation tablets from your survival kit. The alternatives would be to boil the water or to use other chemicals that will neutralise any bacteria such as condies crystals or Betadine Solution from your first-aid kit.

Note:

It is extremely dangerous to use improvised water purification methods and you should ensure you have a reliable water purification strategy.

Portable Water Filters

These are designed for the world's diverse water conditions and usually combine a ceramic filter with activated carbon granules. Worldwide studies have shown, that bacteria accumulates in every activated carbon filter, which is why manufactures now put the ceramic filter after the carbon filter thus eliminating not only micro-organisms such as Giardia, Cryptosporidium, Salmonella, E-Coli and Cholera, but also some chemicals.

To operate the unit, the intake hose is suspended in the untreated water. The filter is held vertically and pumped until purified water begins to flow from the outlet. As bacteria and particles of dirt become trapped on the surface of the ceramic filter pumping will require greater effort. The filter should then be cleaned and not forced.

Note:

Most units do not de-salinate salt water. You should check the exact capabilities and limitations of your unit with the supplier when purchasing.

Shelter

Extremes of heat and cold are the enemies of human survival and both these qualities are found in inland arid regions where very hot days can be followed by cold nights. In the past twenty years sixteen people have died due to excessive heat and thirteen have died due to excessive cold in Western Australia.

A shelter will provide you with protection from the elements, insects and animals. It is also a big psychological boost that will help you feel that you are managing. Determine what type of shelter you require and plan accordingly.

While building your shelter remember that keeping in the shade and moving as little as possible in the heat of the day can avoid heat stroke and loss of body fluid.

Using Vehicles as Shelter

Vehicles are a source of shelter as they provide protection from the sun, rain and prevailing weather during the day and the cold air at night. Tarpaulins, blankets or branches can be used to keep direct sun from the vehicle and interior linings, doors, boot lids and bonnets can also be removed.

Foil Rescue Blanket

Space and/or rescue blankets are cheap, lightweight and an ideal item to assist in providing shelter. The reflective surface reflects the sun's rays from the person sheltering underneath.

Natural Shelter

If nothing else is to hand you will have to use bush materials, when constructing a shelter you should consider the following points –

1. Type of protection required.
2. Availability of materials.
3. Proximity of water.
4. Close to your emergency signals.

When you begin construction, use larger branches for your basic frame, as you will find a roof fairly heavy when it is wet and they will have to support it. Branches can be tied together using vines, strips of bark or sword grass. If you are near your vehicle, strip out wires to use for this.

Remember that your ability to improvise and see alternate uses for items that you may have available to you could mean the difference between life and death.

TYPES OF SHELTERS

Any survival situation will involve the construction of some form of shelter from the elements.

The need for shelter and the type of shelter should be identified in your survival situation appreciation. It is important that you base any decision to build a shelter on your survival plan.

Note:

Be careful not to use items from your survival kit, which might have a higher priority of use.

Building shelters

Your shelter will depend largely on what is available to use and what the conditions are. Common sense will guide you but be warned, a shelter takes a good deal longer to build than one imagines. If you can find something that will provide a part of a shelter such as a hollow log, then use it as the basis of your shelter, this will save time and energy.

Some fairly simple types of shelter, which you can build, with a minimum of effort include the following -

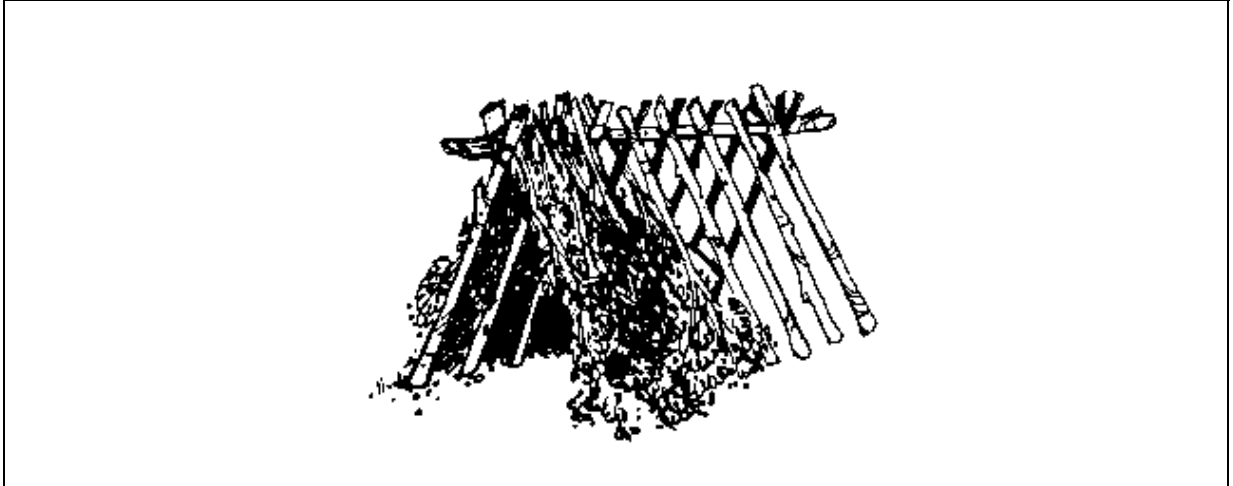

The A-Frame Shelter

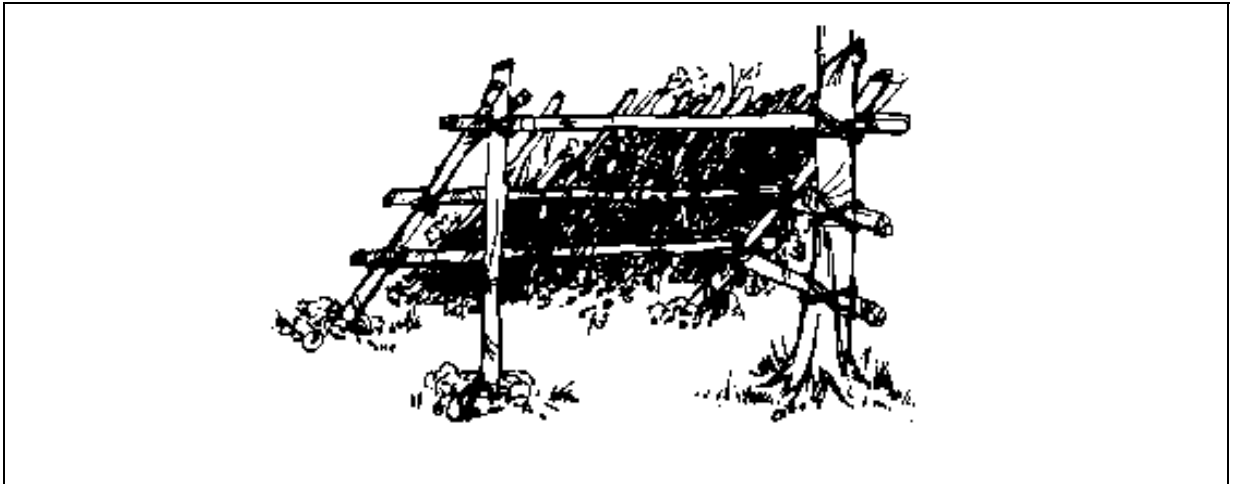

The Lean-To Shelter



The Aboriginal Shelter

Using a tarpaulin/overhang/hootchie for shelter

A tarpaulin, overhang or hootchie can be a valuable aid to providing shelter from the elements as there is no limit to the uses it can be put to. Remember that today they are fairly lightweight and may be dropped to you by rescue aircraft.

In hot conditions they can be used solely as a base to protect from radiated ground heat when used in conjunction with any shelter designed to provide shade. They can also be used in hot conditions to provide deep-shade as the roof of a large A-frame shelter.

In wet, windy conditions they can be used to provide shelter using one end as a base and then using the remainder to provide an outer skin for waterproofing or simply using as a large A-frame with the edges pegged or held in place using rocks etc.

Note:

These items need not be used on their own as shelter but can be utilised to supply additions and improvisations to other forms of shelter you may build.

Roofing

If your vehicle is handy, you can pull out the head lining to use to make a waterproof roof. If not, then blankets, sleeping bags or even spare clothes can be used.

Thatching

Waterproofing and shade can be provided using a technique called thatching. This can be done by using materials such as palm fronds, leafy branches, tufts of long grass, reeds, sedges and/or long stalked ferns. A good method to employ is called “tuft thatching” using long, pliable tufts of grass, reeds or sedges. These are better used when dry or partly dry as they will not shrink and fall apart in windy conditions. To make a “tuft thatch” –

1. Gather the material into small sheaves or handfuls and bend the end of each sheaf over a batten or long stick.
2. Twist a few strands of the material around the sheaf a few times and push it through the bunched up material to hold the sheaf together.
3. Completed “tufts” are then slid along the batten to make a neat thatch.
4. Each completed batten is then lashed to the frame to provide a wall or roof as required when used to overlap completed battens.

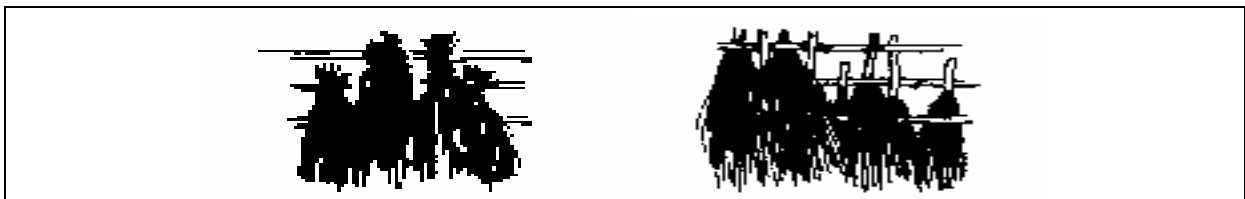

Examples Of Thatching Using Tufts and Fronds

Use Of Debris

Once you have constructed the skeletal structure for your shelter in cold or wet weather you should consider the use of debris for protection and insulation. Over the framework heap a pile of light, soft debris. Leaves, grasses, brush, or any type of leaf litter will do.

The debris should eventually form a large dome shaped mound some 60cm thick over the structure. Remember the thicker the pile the better the insulation and the steeper the pitch the better the rain protection. On top of the debris add some bark slabs or moss to form a protective waterproof layer and to assist in keeping it together.

Low debris shelters built using this method are sometimes called ‘oven shelters’

Warmth

FIRE LIGHTING WITHOUT MATCHES

In Western Australia in the past twenty years, thirteen people have died due to excessive cold. Many of these deaths could have been prevented had the individuals possessed the resources and skills to light a fire.

Fire cooks, warms, sterilises and acts as a signal if necessary. To start a fire requires an understanding of combustion. For combustion to occur requires the presence of fuel, heat and oxygen. Fuel may consist of; dry vegetable matter, dry animal manure, reactive chemicals, kindling and timber. Heat can be provided by friction, chemical reaction, spark or magnification. Remember that oxygen is the essential ingredient to produce flame from heat and fuel.

Always carry some form of fire starter with you on trips such as waterproof matches or lighter. If you do not have these then your skills should include at least one of the following methods. Remember that traditional methods of fire lighting require a high degree of patience and skill and should be learned and practiced in a training environment.

Tinder

Tinder is very important to fire lighting and care must be taken in collecting it to ensure it is dry and suitable. Commercial tinder is available and can be carried in your survival kit.

Some suitable sources of natural tinder are; dry root rot, animal manure, bulrushes, fluff from birds nests and crushed bark and/or grass.

Note:

Make sure that you have tinder prepared and ready when lighting fires.

Vehicle Method

Your vehicle has probably been fitted with a cigarette lighter. Use this to ignite a petrol soaked rag [outside the car]. If you do not have a lighter then remove the battery from the vehicle, pull out two wires from the vehicle and attach these to the terminals of your battery and run them away to the ground. When the ends are touched together they will spark and ignite tinder.

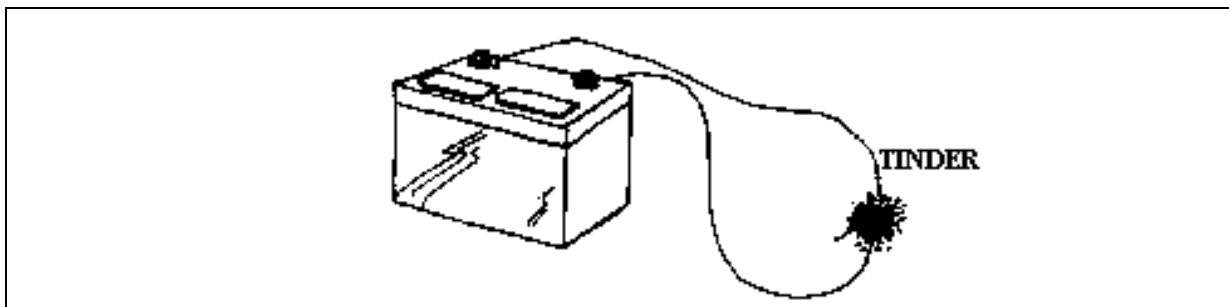

The Battery Method Of Fire Lighting

Note:

The gas produced by a battery is highly volatile and if exposed to a spark could cause an explosion. Make sure the fire is started away from the battery.

The Fire - Bow Method

This method is used by many indigenous people around the world and is also the most difficult of all the methods advocated. It basically involves using the heat caused by friction when rubbing two pieces of wood together to ignite the resultant sawdust [punk] and produce an ember. Western Australian aborigines used a derivative of the method by simply rubbing two pieces of wood together by hand using a circular or sawing movement. The fire-bow method is simpler as it employs mechanical advantage for a more efficient operation.

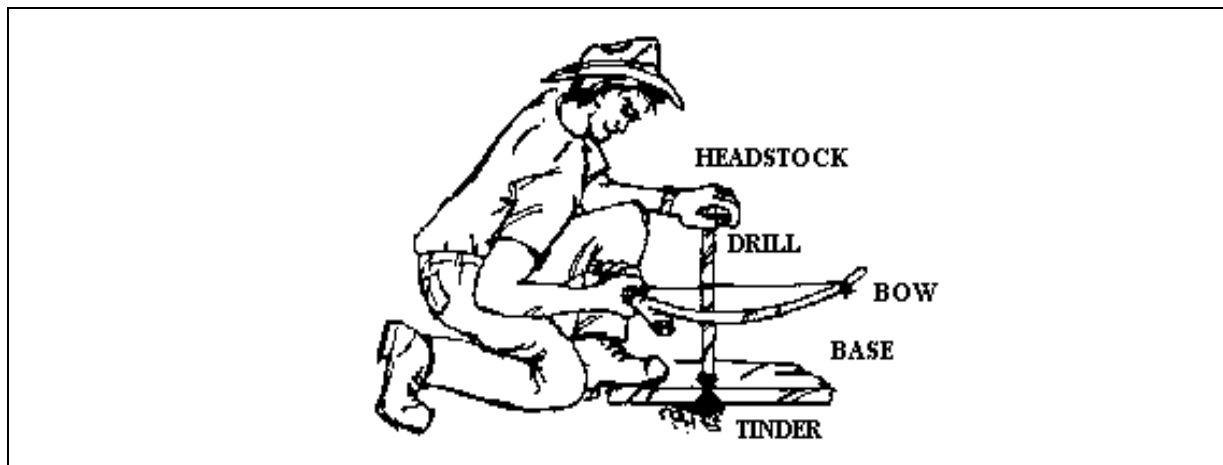

The Fire-Bow Method Of Fire Lighting

Component Parts of The Fire-bow

The base is a piece of dry, soft wood flattened top and bottom so it will sit on the ground. cut a small circular depression on one side of the top of the base and a small groove from this depression into the side of the base directly beside where the drill is to be used to allow the shavings or punk to fall onto the tinder.

The bow can be any branch of a tree and should be approximately 45cm to 60cm long. It can be 'L' shaped or straight but works best if flexible. The bow-string can be string, green-hide, leather thong, bootlace or nylon cord from your survival kit.

The head-stock is a piece of hardwood with a depression cut in to it to hold the top of the drill and allow it to rotate.

The drill consists of a piece of dry wood of soft texture 30 - 40cm long and as straight as possible. The diameter should be 1.5cm to 2cm, the drill sharpened to a point at both ends to fit into the starting groove of both the base and head stock.

Using The Fire-bow

To use the fire-bow take a turn around the drill with the nylon cord attached to the bow with the drill outside the bow [if you have used green timber for a bow the tension will be applied automatically, otherwise use your fingers to hold it tight].

Place the tip of the drill into the depression in the base and hold the headstock onto the top of the drill. Push and pull the bow to rotate the drill. The over-heated shavings [punk] will fall through the groove in the base onto the tinder.

The small ember, which will form, should be held in the tinder and blown until it ignites.

Note:

One of the better types of wood to use for both the drill and base is the lower wooden portion of the flower stalk from the balga plant.

Torch Battery Method [6V]

A fire can be started by holding very fine steel wool from your tool kit over the negative terminals of a 6-volt torch battery and brushing it against the positive terminal.

The sparks produced should ignite the steel wool [make sure you have tinder ready].

The Lens Method

Strong sunlight focused through a convex lens can produce enough heat to ignite tinder. The lens can come from a magnifying glass [including the base of some compasses], binoculars, camera or telescopic sights from firearms.

Flint, Steel and Magnesium Blocks

Flint is a stone which if struck with a piece of steel produces sparks. Magnesium blocks with flint attached are available commercially for use as emergency fire-lighters.

These are used by scraping off shavings of magnesium with a knife blade then striking the attached flint with the back of the knife blade and directing the resultant sparks onto the shavings.

Some of the commercial fire-starters come with their own supply of tinder.

Chemical Methods Of Fire Lighting

While your survival kit may not contain a great quantity of chemicals your situation may produce some common agents that can be used to start a fire.

Condies Crystals and Sugar

Condies crystals [carried in some survival and/or first aid kits] can be used to start a fire by mixing in equal amounts with sugar [barley sugar can be used] and grinding them with the flat of a knife blade. The result is a brief intense flame.

Condies Crystals and Brake Fluid

A brief intense flame is attained by adding small quantity of brake fluid to a teaspoon of condies crystals. The resulting chemical reaction will produce a flame in approximately 15-20 seconds. The mixture should be left alone and not stirred while waiting.

Condies Crystals and Glycerine

Chemical reaction should produce a brief flame in approximately 15-20 seconds if a few drops of glycerine are added to a teaspoon of condies crystals.

Food

LIVING OFF THE LAND

Although food is not as important as the other three requirements for survival it is necessary for a prolonged survival situation. Any available foods should be eaten sparingly, keeping in mind that it is better to have one meal a day than to nibble small amounts.

The average healthy adult can live for several weeks without food so this will give ample time to locate nourishment from natural sources if necessary.

Food sources

Sources of food available to survivors include; animals, bird life, marine life, insects, grubs and plant life. In considering natural sources of food, there are some important points to remember

- Most animals, bird and plant life are protected and should only be used for food sources in emergencies. Should it be necessary only kill what is needed for survival.
- The body needs fluid to digest food, so foods with a high water content should be considered before others. If no water at all is available, then food should be avoided, particularly meat, which requires more fluid to digest than vegetation.
- You do not need to be a skilled hunter to obtain food. Even without weapons of any kind enough lizards, insects and grubs can be found to keep a person alive for several days simply by looking under rocks, dead branches, tree stumps and anthills.
- If possible all foods should be cleaned carefully by washing, then cooked, thus lessening the chances of any infection or stomach upsets.
- Generally bush food is tough, fibrous, unpalatable, and to some, even nauseating; nevertheless it is food.

THE FOOD PREFERENTIAL

Most people when forced to live off the land will find it easier to try to eat food that reminds them of their normal diet at home.

Because early settlers in Western Australia were mainly British this heritage still shows in our choice of food and we tend to categorise our food preferences to what we recognise and feel comfortable with. For instance after eating snake when asked what it tastes like we will invariably reply –‘chicken’. Our food preferences can be divided into three classes.

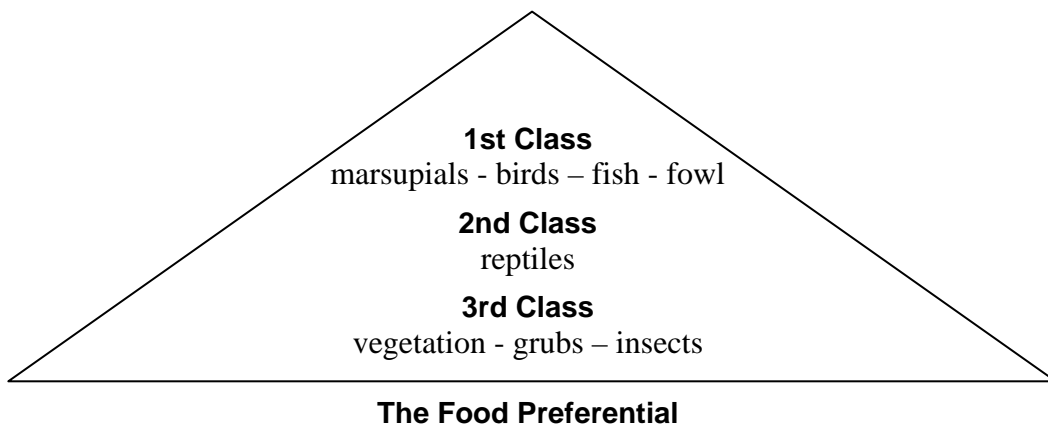

ANIMALS

The presence of any animal or bird life in an area is evident by tracks, droppings and traces of fur or feathers. If you have been lucky enough to find a waterhole used by animals it is a simple matter to sit under cover, down-wind from the water source and either shoot or snare the animals as they come to water.

Even by walking through the bush quietly during the day it is possible to surprise sleeping animals in creek beds, under shady trees and amongst rocky outcrops.

Some of the most likely animals seen in the bush include kangaroos, small marsupials, wild goats, donkeys, pigs, rabbits, snakes, lizards, frogs, sheep and cattle.

Some imagination and bushcraft skills are needed in knowing where to look, how to recognise tracks and how to snare the faster moving animals.

SNARING ANIMALS

It should be remembered that the use of traps and snares is illegal in Western Australia and must only be used in survival situations when your life is in danger.

The Animal Snare

Without a firearm or manufactured animal trap most animals can be snared with a wire noose placed in a convenient position such as the entrance to a hole or above an animal path between two trees.

The noose should slide freely and the other end of the wire should be anchored securely to a tree or post. As the animal passes through, the noose tightens around the neck quickly killing it as it tries to pull free. This type of trap is generally successful at night when the animal cannot see the snare. Care should be taken not to leave any human smell on the wire.

Owing to the cruel nature of the snare, it should only be used when other methods fail.

If setting a snare look for signs of fur around a tree's base or signs along a fence line to indicate where an animal has passed through. Animals will return to the same place to sleep and will continue to negotiate fences at the same spot.

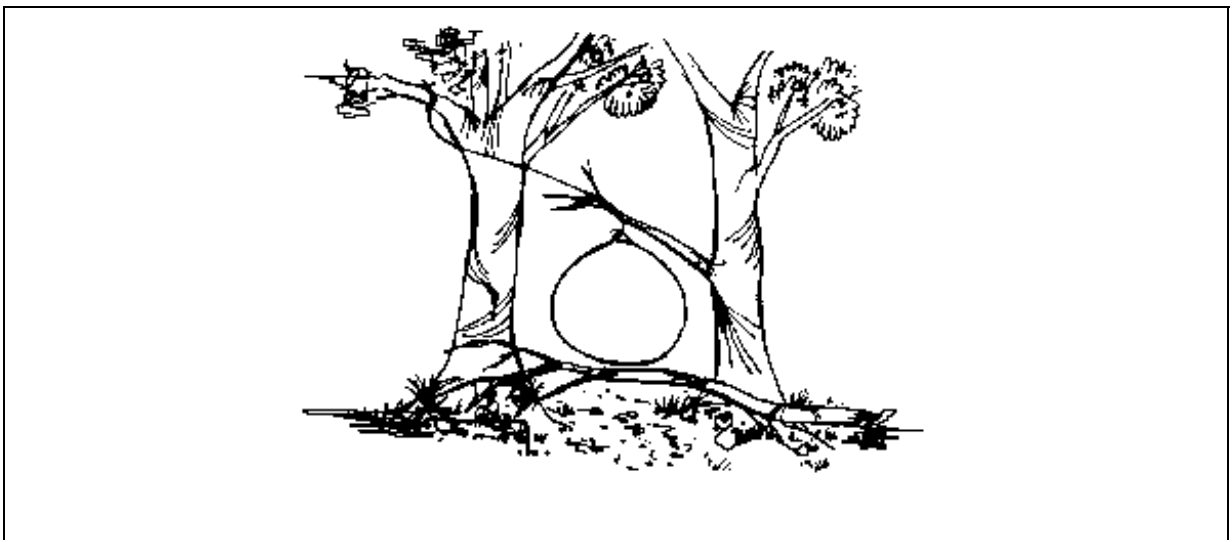

The Animal Snare

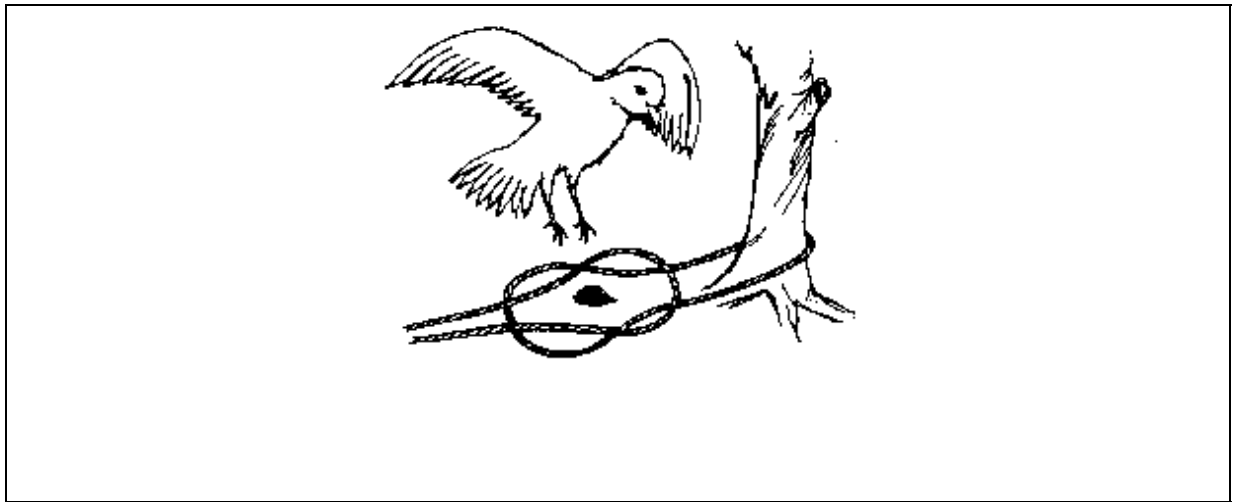

The Reef Knot Snare



The Possum Snare

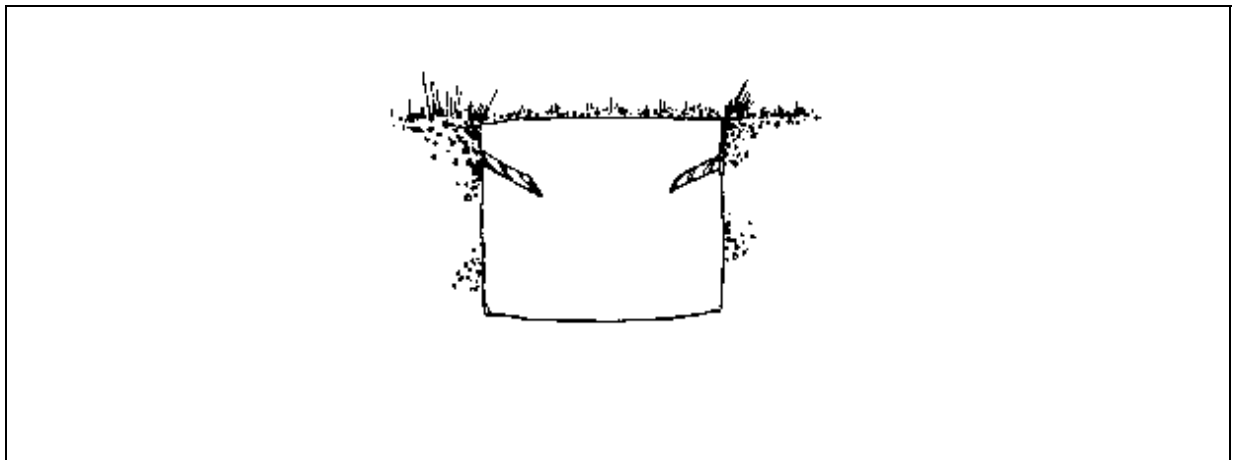

The Pit Trap

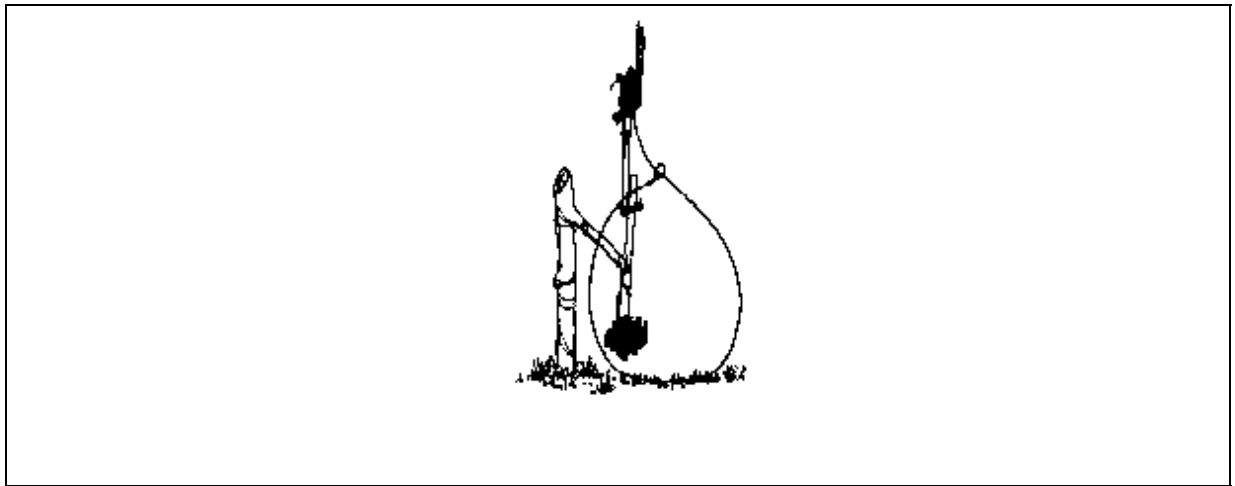

The Bait-Stick Snare

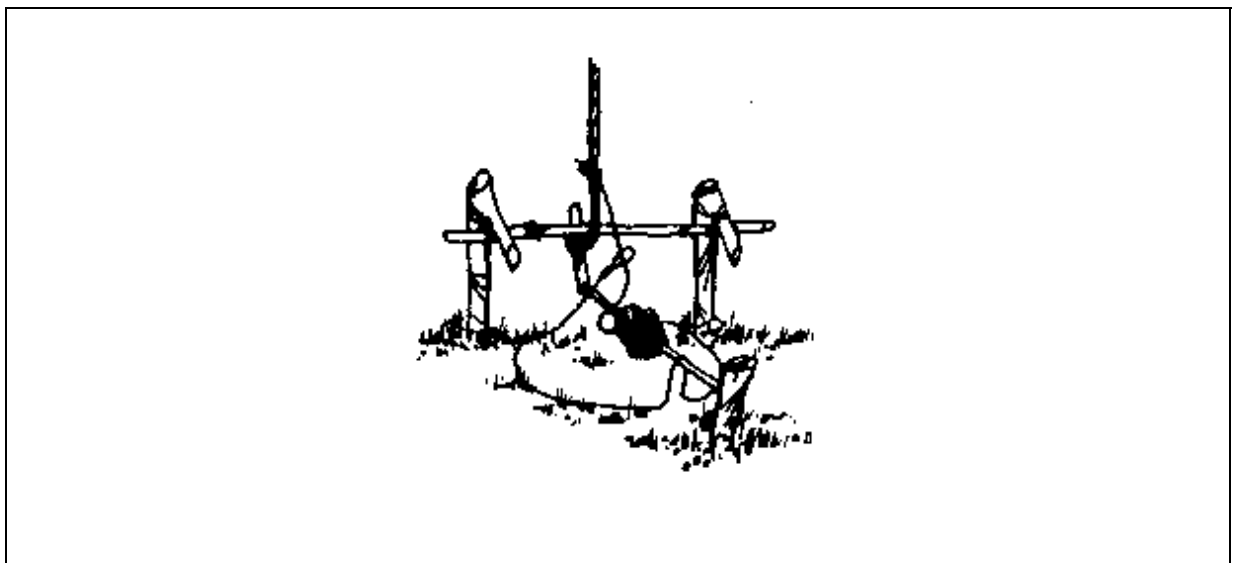

The Toggle Stick Release Snare

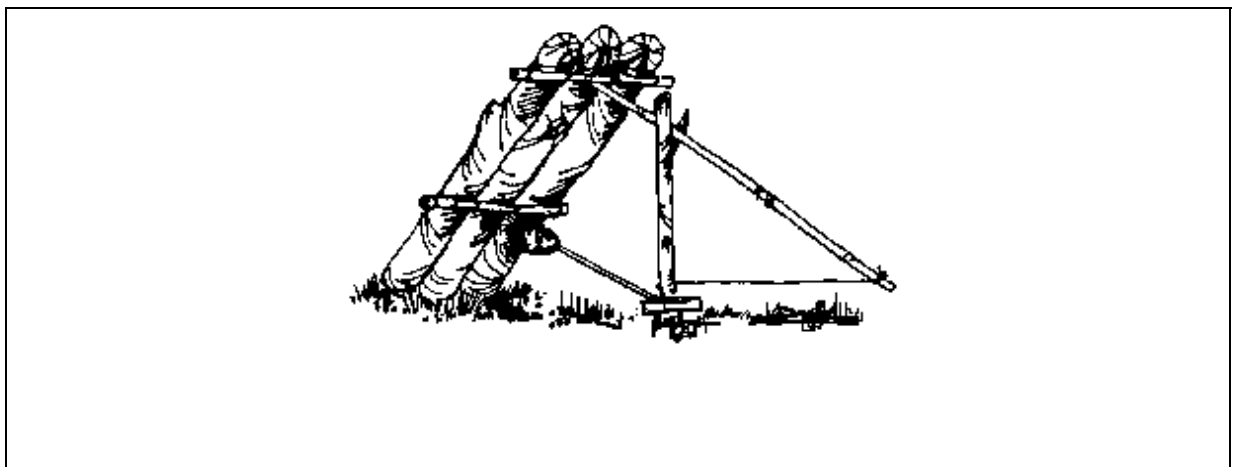

The Toggle Stick Deadfall

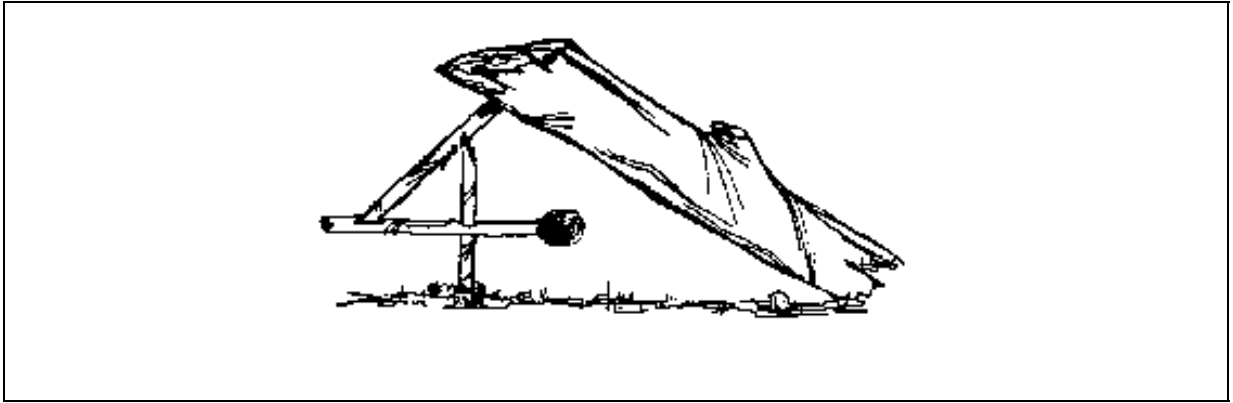

The Figure-Four Deadfall

Remember traps and snares are illegal in Western Australia and should only be used in survival situations when your life is in danger.

BIRD LIFE

Ground feeding birds can be trapped by placing grass or other bait under a cage made from wire netting or green sticks woven together. The cage is propped up with a stick that is pulled out by a hidden observer tugging a string as the bird walks under the cage. The cage falls, trapping the bird.

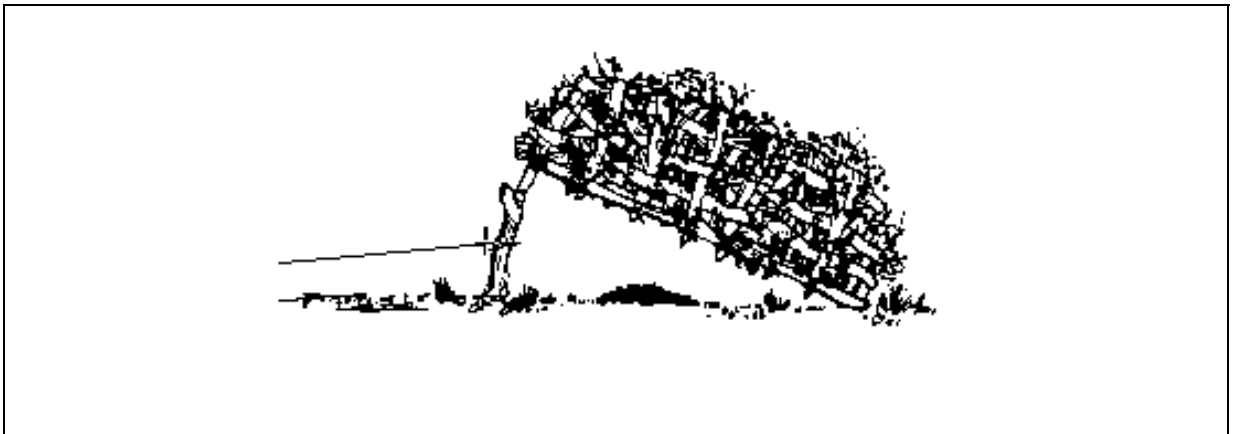

The Bird Trap

A fishing line can also be used successfully. Bait the hook with an insect, bread, or other edible matter; tie the line to a tree or stick where the birds frequent.

Birds are rather difficult to shoot or trap because of their flighty nature but you may be lucky enough to locate a nest, either on the ground or in the trees, containing eggs or young.

Most birds try to confuse intruders by flying away from their nest at the approach of any danger. This has the effect of leading the intruder in the wrong direction, thus protecting the eggs or young.

Emus are very common in outback areas and can be enticed towards bright objects waved by a person hiding behind a bush. As the bird's inquisitive nature leads it within metres of the object, the person can then step out and kill the bird with a suitable weapon.

When shooting or trapping, frequent a water source if possible. Stealth, not speed, is of great importance when shooting and patience at a water hole at dawn or dusk is usually rewarded.

MARINE LIFE

Fish are a valuable food source containing protein, vitamins and fats. All freshwater fish are edible. It takes skill to catch fish but by considering their feeding habits and following some simple methods you can be successful.

Where to fish

Fish frequent those places in the water where they are most comfortable and where they can feed. The ambient temperature of the area will affect these places. You should remember –

- If it is hot and the water is low they will seek shaded, deep water.
- In cold weather they will choose a shallow place where the sun warms the water and in lakes they will keep to the edges where the water is warmer.
- If the river is in flood they will seek slack water generally on the inside of bends or in small tributaries feeding into the main stream where the water may not be so turbulent.
- Fish and marine life like to shelter under banks or below rocks and submerged logs.

The Forked Fishing Spear

Fish can also be speared using a forked fishing spear. These are more effective than a single pointed spear at holding a speared fish and are made from a green sapling, split at one end and carved into two sharp prongs complete with inward pointing barbs. Before carving, separate the prongs with a wooden wedge then lash the two prongs together using cord from your survival kit. After carving the spear can be hardened over a fire.

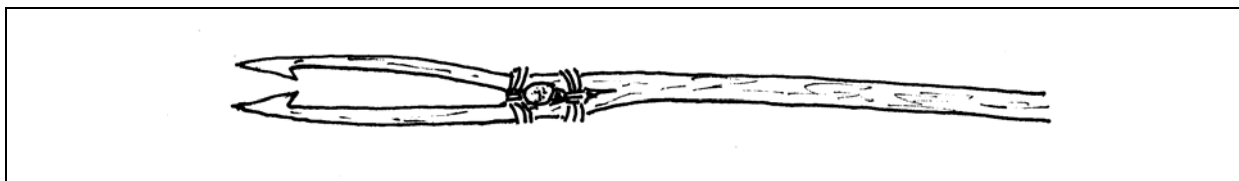

The Forked Fishing Spear

Tidal Fish Traps

Fish can also be trapped near the water's edge by using a fence of upright sticks or rocks pushed into the sand close together and left in place. This type of fish trap is used by fishermen in tropical areas with extreme tides where netting is used in place of the sticks. The fish are trapped by the mesh of sticks or rocks and easily removed when the tide goes out.

Gathering Shellfish

A method of gathering seafood on the coast is by digging in the sand or turning over rocks for shellfish at low tide. This is how some fishermen collect bait for line fishing.

The Marron Snare

A traditional method of catching marron is to tie a small piece of meat to a length of cord or fishing line and throw it a metre or two into the water. In clear water you will see the marron coming to the meat. Once they take the meat they will hang on stubbornly and can be drawn to the edge of the water and lifted out onto the bank.

Marron can also be caught by using a pole with a running loop of snare wire tied to the end and placing it over the marron from behind and dragging them out of the water.

The Basket Trap

Freshwater crustaceans [marron, etc] can be caught in simple basket traps baited with animal entrails or decayed meat and left in position. They should be fitted with a funnel at one end and tied together at the other. It is important they be weighted down, staked in position or tied to the bank to ensure they are still there when you check them. To make a basket trap –

1. Cut a bundle of green sticks 1m in length and mark out a circle on the ground the size of the end of the trap. Make holes in the ground around the circle with a stick every 4cm and stand a stick from your bundle in each hole.
2. Weave around the bottom of the trap three times with a long piece of thin green stick and tie off with cord to keep it together.
3. Tie the top of the trap together with a piece of cord to form a cone shape and weave a length of thin green stick around the trap basket fashion.
4. Make a smaller similar cone with the narrow end open and place it inverted inside the large cone to form a lid and entry.

REPTILES

All reptiles are edible including venomous snakes [remove the head and portion of the neck to remove the venom glands]. Goannas being reptiles are fatty and oily so if you have to eat these, overcook them. Remember, care must be taken when catching venomous snakes and other reptiles, as their bite can be fatal or lead to infection.

Note:

Since 1983 thirty-nine deaths have been attributed to snakebite in Western Australia.

GRUBS**Witchetty Grubs**

Witchetty grubs are found after examining for the characteristic borer holes and by digging up the surface roots of the Witchetty Bush [acacia kempeana] in the central desert area. They live on the dissolved sugars from the sap of trees, are highly nutritious and are high in calcium. Entrails should be removed by pulling the head and the tail apart.

Note:

Do not eat furry grubs or grubs with black showing through the skin and remember that while snails and slugs can be eaten they are an unlikely source of food as they favour wetter areas and there would probably be better alternate food available.

INSECTS

Insects and their larvae are often overlooked as a source of food even though they are widespread, a good source of nourishment, have a high food value, high fluid content and are easy to obtain. Fried termites and ant larvae are a rich source of food [100gms = 2,200kj].

Termites

In some overseas countries, maggots, grasshoppers and termites form part of the natural diet. Termites can be obtained by picking them up on the end of a wet fingertip after breaking open anthills or dead wood. The taste of termites and ant eggs is not offensive.

Honey Ants

Honey ants can be collected near the base of trees in the arid zone and on the branches in tropical areas. The fluid from their abdomens is good nourishment as is honey from wild bees.

Green Tree Ants

Found in the northwest in simple leaf nests sewn together by larval silk. Although very aggressive their bite is not considered dangerous. A good source of Vitamin-C when crushed and added to water to make into a drink or crushed and added to food for flavour.

ANIMAL BUTCHERY

Most animals can be eaten although most of us have a preference for herbivorous animals such as cattle sheep, pigs, horses, rabbits and poultry. There is no reason however, that you cannot eat vermin in a survival situation.

Signs Of Disease

Check all animals for disease, the body should look well fed and be clean smelling. If in doubt a small piece of meat can be boiled in a covered pot, when the water is boiling if the vapours have a bad smell you should not eat the meat.

Do not eat birds when the flesh is flabby, purple, a green discoloration around the neck, stiff feet, collapsed eyes or a sour smell present. If you can pull out a rabbit's fur, if its eyes are enlarged and dull or its body cavity slimy it should not be eaten.

PREPARATION & COOKING OF GAME

The size and type of animal will determine your method of preparation for cooking.

Large Animals

Should have the throat cut to 'bleed' the carcass, hung up by the hind legs, the gut contents, head, and skin removed then cut into joints.

In a survival situation meat can be cooked by boiling, frying, grilling, baking or steaming depending on what resources are available.

Kangaroo

Kangaroo meat is very low in fat and very high in protein and iron. Because of its low fat content it tends to dry out quickly and must be cooked carefully. Cook it quickly by grilling over an open fire as steaks or kebabs.

Emu

Emu meat is very low in fat and high in protein, iron and vitamin C. It is red in colour and similar in texture to lean beef. The tenderness and texture of the meat enables it to be prepared in many ways. It is best cut into thin steaks and lightly grilled over an open fire.

Rabbits

Should be skinned, gutted and have the head and feet removed. They are best cooked by inserting a green stick in the body cavity and turning them over hot coals.

Snakes

Should have the head, skin and stomach removed and be cut into pieces. The meat is best grilled over hot coals.

Lizards

Are prepared simply by removing the head and gut contents. They are best grilled over hot coals with the skin left on.

Birds

Should be bled as soon as possible after death and have the head, feathers and the intestines removed. Birds can be cooked by wrapping them in foil from your survival kit, clay, large leaves or paperbark and placing them in the coals.

Fish

Fish should have the intestines removed and be cooked with the scales and skin on. They can be wrapped in foil from your survival kit, bark, leaves, mud or clay and cooked in coals.

Note:

Remember to wash all meat of blood before cooking, make sure that you wash all blood and meat from your hands after handling dead animals.

PRESERVING MEAT

The most popular methods used to preserve meat in a survival situation are by drying or smoking. It must be remembered that only fresh meat should be used to ensure protection against infection.

Drying meat

Drying meat is a good method for preserving it if you have more than you can eat immediately. It is also advantageous if it has to be eaten over a period while travelling on foot as the weight of the meat is reduced by approximately 70%. This is because the water content of the meat is removed in the drying process leaving behind the tissue containing protein and nutrients. Dried meat cut with the grain is known as 'biltong' and across the grain as 'jerky'.

The process for drying meat is –

- Construct a simple tripod frame to hold the meat strips.
- Cut the meat into thin strips and remove all fat and gristle as the fat will not dry and will encourage the growth of bacteria. The thinner the strips the faster water will be extracted. It is best to cut a small hole in one end of each strip of meat and pass a stick through the hole rather than folding the strips over the stick as this provides an area on the underside of the meat that will not dry and will harbour bacteria.
- Hang the strips in a sunny, breezy spot for 2-3 days to sun-dry it or place it alongside a slow burning fire to smoke it until the meat goes hard to the touch and dark in colour. When meat is smoked the smoke will solidify the protein content of the meat and stop decomposition and seal in any flavour.
- When smoking meat do not let the fire produce flames and remember that the best way to produce smoke is to use sawdust, wood chips or crushed bark as fuel for your fire.
- During the day you will need to keep flies, insects and scavengers such as birds, goannas, dogs, cats and rodents away from the meat. It is a good point to remember that any scavengers attracted to the drying or smoking meat may also be a source of food to be trapped or killed.
- At night all the meat strips should be taken off the drying-frame and wrapped in material to protect them from dew and moisture.

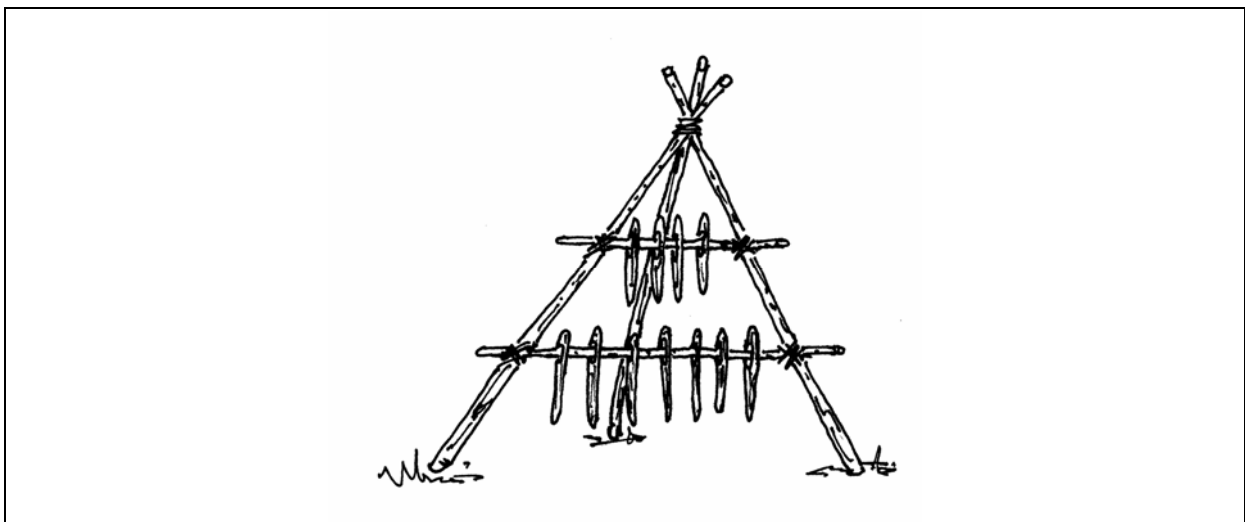

The Tripod For Drying/Smoking Meat

EDIBLE PLANTS

A vast number of plants that can provide food in an emergency occur naturally in Western Australia. However, many of them are hard to identify without expert help and many more have sharp or tangy juices that discourage people who cautiously taste them. It is recommended that when travelling around the state you should source information on edible and poisonous plants from locals, resident experts and local authorities relevant to their area.

PLANTS TO AVOID

The seeds of many of the native pea and bean family are highly poisonous. It is best to avoid these native plants even though garden varieties are good to eat. After all, if you are already working hard at surviving, you do not want to add illness to your misfortunes.

You should also avoid the palm-like plants. *Zamia* palm fruits contain poisons and so do the young shoots. Unless you are absolutely certain of the identity of the palms that you are about to eat they are best left alone.

Fungi are another group of plants best avoided. Although many of the fungi that are found in Western Australia can be eaten they provide little nourishment and there is no rule to eliminate the deadly species.

THE 'TASTE TEST' FOR PLANT EDIBILITY

Should you find vegetation that you think is edible you must carry out the taste test to reduce the chance of eating something that will harm you.

Choose young, healthy looking plants and remember testing must be done in order and the test stopped immediately if any discomfort or adverse reaction is experienced.

You should wait approximately 5 minutes between stages and remember that each stage of the 'taste test' must be done using a fresh sample of the plant being tested.

LOOK

Does it look like something you can eat? Look for poison indicators such as prickles or milky sap. Another indicator is any fruit that is divided into five divisions. Discussion with experts will indicate peculiarities specific to particular regions.

SMELL

Break open, crush it and smell it. Be wary of things that smell like almonds or peaches.

TOUCH

Rub on to a tender part of your body such as the inside of the wrists and wait approximately 20 minutes to see if a rash develops.

TASTE

Rub on the inside of the lip and top of the tongue, testing for flavour and reaction. The plant should be discarded as a food source if a sharp, stinging or burning sensation is present.

EAT

Eat a very small portion if all the above tests prove negative and wait for a few hours to see if there are any reactions. If there is no reaction then you may eat a larger portion, continue to do this until you are sure that even large quantities will not harm you.

Note:

Always carry out the taste test on anything that you cannot positively identify and remember should the part you have tested prove to be inedible then do not discard it as cooking may make it edible. If one part of a plant proves to be inedible then you should be prepared to test the other parts [roots, leaves, etc].

SOME COMMON TYPES OF EDIBLE VEGETATION**Australian Bluebells [*sollya heterophylla*]**

A hardy rounded shrub or climber that rambles through adjacent trees and shrubs with edible, fleshy, blue-black fruits, which turn translucent when ripe

Banksias [*banksia* sp] & Grevillea [*grevillea* sp]

The flowers from the banksia family contain large amounts of sweet nectar that can be sucked directly from the flower or stirred in water to make a refreshing sweet drink. For best results this should be done early in the morning when dew is present.

Balga [*xanthorrhoea* sp]

Grows in the form of a grass tree that is widespread and common in a variety of habitats, especially low-lying damp areas. The flowering stems have an edible gum and the white tips of the green leaves are also edible, this is quite sweet when eaten raw. The plant is killed when you remove this growing heart.

Berry Saltbush [*rhagodia baccata*]

A spreading shrub that grows to 2m with short, grey-green leaves that grows near the coast in dunes and limestone outcrops. It produces small edible red berries that are very sweet when ripe. The leaves can also be boiled and eaten like spinach.

Bloodroot Yams [*haemodorum* sp]

These plants consist of brown-black flowers on slender stalks and are common in the south of the state and grow to 2m. The bulbs are eaten raw or roasted. They are sweet, juicy and hot, somewhat resembling a very mild onion in flavour but with considerable bite.

Boab [*adansonia gregorii*]

The nuts should be collected when mature but before they harden, the seeds and pith can be eaten raw or soaked in water, they have a taste like dried condensed milk.

Bracken Fern [*pteridium* sp]

This and some other large ferns are edible while the green shoot is in the "fiddle head" stage. Although they can be eaten raw, they are more palatable when cooked, the underground stems although stringy are rich in starch and roast up well in the campfire.

Bush Tomato [*solanum diversiflorum*]

These grey coloured shrubs grow to about 50cm and have prickles on the stem and leaves, the flowers are purple. The fruit when ripe are pale yellow with black seeds surrounded by pulp. The fruit is cooked in ashes, the seeds removed and the flesh eaten.

Bulrush [*typha* sp]

These plants generally grow along the edges of lakes, swamps and large dams. The horizontal stems are rich in starch but need pounding to separate this from the strong fibres running through the plant.

Christmas Tree [*nuytsia floribunda*]

A small tree that grows to 8m. The young roots are edible and are peeled and eaten they have a moist brittle centre that tastes like sugar. The flowers can be soaked in water to make a sweet refreshing drink and the gum can also be eaten.

Coastal Sword Sedge [*lepidospermia gladiatum*]

This plant grows to 2m and grows in coastal sand dunes and woodlands in wet areas. They are identified by their long dark green sword-like leaves. The base of the stem is edible and can be eaten raw or roasted.

Desert Raisin [*solanum centrale*]

A small shrub with purple flowers and soft leaves that usually grows to 30cm in spinifex sandplains and dunes. The fruit is eaten raw when green-white to yellow-brown. When dried it has the taste and appearance of a dried sultana and can be stored.

Desert Kurrajongs [*brachychiton* sp]

Identified by their boat shaped pods filled with shiny, yellow seeds. Use a stick to remove the seeds as the small hairs surrounding them are irritating to the skin. The seeds should be winnowed by pouring between two containers to allow the wind to carry away the prickly hairs then pounded and roasted with a little water to make porridge or roasted until black and then crushed and used like ground coffee to provide a drink.

Desert Figs [*ficus* sp]

Wild figs of one kind or another are found across much of Australia's inland. They grow as a large shrub to 4m, their glossy, green leaves are very distinctive and the red, pulpy, ripe fruits are excellent eating. Dry fruits can be collected from under the trees and ground into a paste which can be eaten raw or rolled into balls and stored for future use.

Emu Plums [*podocarpus drouynianus*]

A low growing shrub found in the southern forests that yields a dark purple, edible fruit of good flavour. The attached green "seed" should be discarded.

Geebung [*persoonia* sp]

These shrubs or small trees grow to 2m and are found mainly in the south of the state. The pulp from the small green-yellow fruit is edible and tastiest when collected from beneath the tree, the skin and seeds should be spat out. These are also known by the unappetising name "snotty-gobbles".

Milkmaids [*burchardia* sp]

Small plants growing to 30cm with white flowers maturing to pink with a brownish centre. The root tubers are edible and can be eaten raw or roasted.

Native Banana [*leichardtia australis*]

Is a vine with greyish leaves, tiny flowers and white, milky sap. Even though milky saps usually indicate that poisons are present, these immature, large, greenish, pear shaped fruit can be eaten raw or cooked, once ripe only the yellow seeds are edible.

Native Yam [*dioscorea* sp]

A climber that grows to 2m in low-lying ground among basalt and granite outcrops. The tubers are edible and are roasted, pounded and then eaten.

Pigface [*carpobrotus* sp]

A succulent prostrate shrub has red-grey trailing branches that grow to 2m. They are found in sandy areas of the state near the coast. Although the water in their fleshy leaves is a little salty it can be purified. When the petals drop off the flowers the purple-red base is revealed and the juicy centre of seeds in a white pulp can be eaten.

Pigweed [*portulaca oleracea*]

A succulent annual with red-brown stems lying flat on the ground these are widespread in arid regions. The leaves are high in vitamin-C and can be eaten raw or boiled like spinach. They can be used as a source of water if no trees are available for transpiration by placing them in foliage bags.

Quandong [*santalum accuminatum*]

A common medium tree growing to 6m that favours sandhills and sandy plain country. They are well known for their round, wrinkled seeds the roasted kernels of which are edible and quite nutritious. The bright red, outer flesh of the ripe fruits is also edible tasting somewhat like an unripe apple. A related species, the Native Plum [*santalum lanceolatum*] bears a tasty, dark purple fruit.

Ruby Saltbush [*enchylaena tomentosa*]

A straggling shrub growing to 1m. The edible fruit is berry-like, small, green or bright yellow turning red when ripe. They are collected by shaking the branches over a container. The young leaves can be eaten after boiling in two changes of water to remove bitter soluble salts.

Sandalwood [*santalum spicatum*]

A shrub that grows to 4m in areas of red loam or on granite outcrops. The fruit are spherical with a thin green or brown skin. The nuts contain a white kernel that is edible.

Wandoo [*eucalyptus wandoo*]

A smooth-barked gum tree that grows to 30m the outer parts of the roots can be scraped off and eaten to provide a sweet, juicy delicacy. The flowers produce abundant nectar, which can be collected by soaking the flowers in water and then drinking the water.

Watercress [*rorippa nasturtium-aquaticum*]

A trailing, herbaceous perennial found in fresh, flowing water. The leaves and stems can be eaten raw or cooked as a vegetable.

Water Lilies [*nymphaea sp*]

These are common to the northern part of the state and are among the water plants that have edible tubers or potato like growths at the base of the stems, they taste best when roasted in the ashes of the campfire. The stems of the leaf and flower of the giant water lily have the texture of celery and can be eaten raw.

Wattle [*acacia sp*]

These shrubs grow to 3m and are common in sandy and limestone soils. The hard black seeds are ground to a chalky white powder that can be eaten raw, cooked as a damper or mixed with water into a drink.

EDIBLE INSECT ACTIVITY ON PLANTS**Sugar Bread** [*lerp scales*]

Small sap-sucking insects that feed on plant sap extract the nutrients they need and then excrete a crusty white substance on gum leaves known as lerp scales. These sweet tasting crusty particles can be eaten or dissolved in water as a refreshing drink and were an important source of carbohydrate to traditional aboriginal people

Mulga Apples [*insect galls*]

These are insect galls and are the result of a wasp that burrows under the bark of Bloodwood and Mulga trees. The galls are approximately 2-3cm across and contain a small amount of fluid and an edible grub. The soft fleshy part of the gall and the grub itself can be eaten.

Direction Finding

If stranded it is best to stay with your vehicle or aircraft, as searchers will find this easier to locate than a lone person. When you have become isolated from a walking party however and find yourself lost without a compass you will have to know how to navigate without map or compass to proceed on your pre-set escape route to safety.

Sun Movement

The sun's position north or south of the equator is called declination. It is furthest north on June 21, crosses the equator on September 21, is furthest south on December 21 and re-crosses the equator on its way north on March 21. Any east-west line indicated when the sun crosses the equator on the 21 March and the 21 September will be accurate.

WATCH METHOD

To find north using your watch simply -

1. Stand holding your wristwatch horizontal with the figure 12 pointing at the sun
2. Bisect the angle between the hour hand and the 12 O'clock position
3. The line will indicate approximately north and is accurate within 5-8 degrees

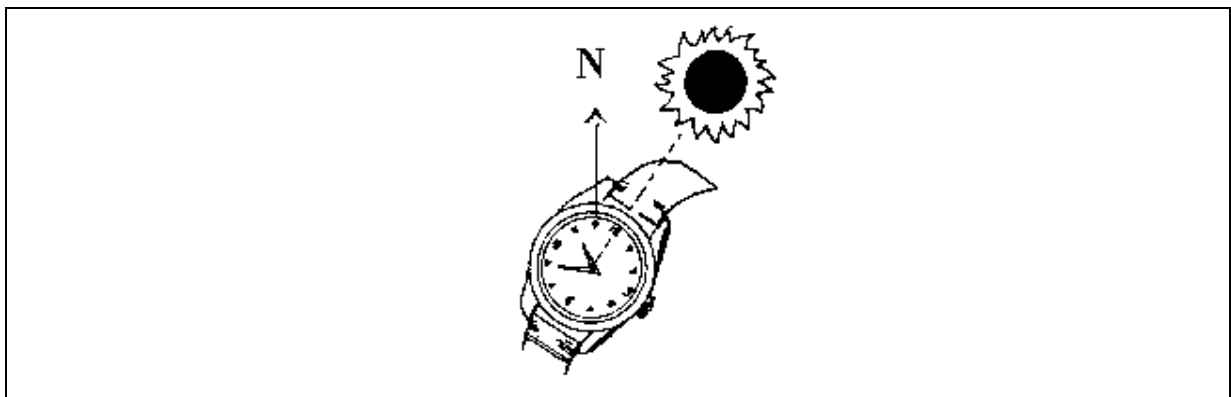

Direction Finding Using A Wrist Watch

Note:

This method will not apply to areas north of the Tropic of Capricorn during the period of the midsummer equinox for your area.

TRADITIONAL BUSHMAN'S METHOD [KANGAROO WALLOWS]

Early settlers often gained a rough estimate of south by remembering that kangaroos rested in areas of shade during the heat of the day. They were aware of signs of disturbed earth where the kangaroos scooped out a hollow in the shade of low bushes. As we are in the southern hemisphere the shade areas were always on the southern side of the bushes.

Note:

This method is still applicable and may provide an easy method of direction finding.

HAND SPAN METHOD

The sun crosses the imaginary north/south line [meridian] every day at noon and there are 24 hours between crossings of the meridian. During this time the earth revolves through 360°. It can therefore be said the sun travels from east to west at a speed of 15° per hour. To find north simply note the time and plot the sun from its present position backward or forward as the case may be to its noon position. The diagram below will give you a general indication of measuring degrees using your hand span. You can experiment with this method and increase accuracy by measuring sun movement with your hand and then measuring it with a compass for comparison.

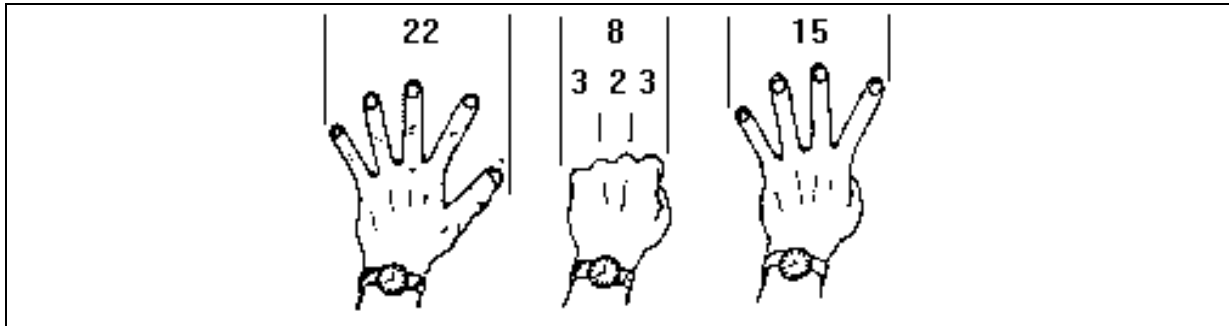

The Hand-Span Method Of Measuring Sun Movement By Degrees

THE SHADOW STICK

To use the shadow stick method -

1. Push a stick vertically into the ground
2. Place a stone at the end of the shadow
3. After a wait of 20 minutes place another stone at the end of the shadow
4. A line drawn from the first stone through the second stone will be a west-east line
5. Face the stick with your left foot between the stones and your right foot past the stones on the line drawn and you will be looking north
6. This method is accurate within 2-3 degrees [is more accurate when taken over an hour]

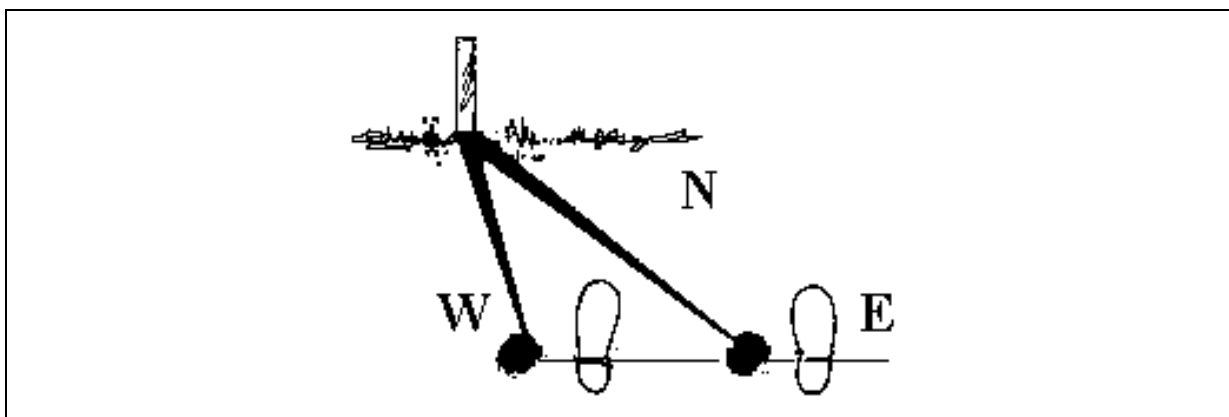

The Shadow Stick Method Of Direction Finding

Note:

In midsummer in areas north of the Tropic of Capricorn the shadow stick will be behind you.

THE SOUTHERN CROSS METHOD - AT NIGHT

The Southern Cross can be used to indicate south at night by –

1. Extending an imaginary line through the long axis
2. Locating the two pointers and bisecting them at right angles with another line.
3. Where these two imaginary lines meet drop a line straight down to the horizon
4. This will indicate south [approximately]

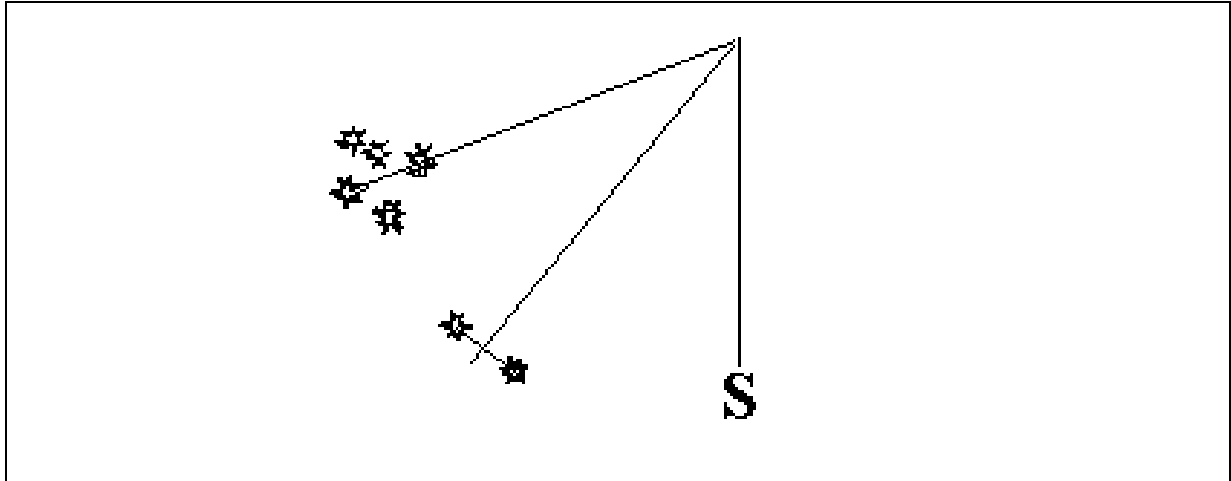

Direction Finding At Night Using The Southern Cross

NAVIGATING AT NIGHT WITHOUT A COMPASS

You will find it very easy to navigate using the stars, particularly in the more arid regions of Western Australia.

You will need to establish where north or south is then draw a earth compass on the ground by drawing a line on the ground indicating north - south, bisect this line with another line at 90°, this will show east and west. You now have your earth compass.

Once you decide in which direction to travel, you can stand on your makeshift compass and face the direction you intend moving. Look for a bright star or better still, a group of stars that are in the required direction and move towards them.

Try to select stars that are not right on the horizon as you will lose sight of these when moving around trees.

Remember that stars move from east to west in the same manner as the sun and you will have to allow for this at 15° per hour.

Note:

Stop periodically and check your direction by drawing your earth compass on the ground again.

Emergency Procedures

In the interests of prior planning and preparation those who live, work or travel in the outback of Western Australia should be prepared for any foreseeable emergency whether they are on foot or in a vehicle. 'Actions on' should be planned and the knowledge and skill to carry them out should be acquired through training.

A personal first aid kit and a personal survival kit should always be carried, notifications should always be posted and safe practices must be a priority.

PROCEDURE IF LOST

If you do become lost, try to remain calm as panic will put you at a psychological disadvantage, the situation is not as hopeless as you may think.

If by any chance you have taken the wrong track and do not know where it is going to lead you, it is pointless going on any further. It would be safer to return the way you came by retracing your tracks back to a point where you can establish your location.

Case histories reveal that most people, when lost push on blindly in a state of panic, hoping that they might end up 'somewhere'. In these cases their efforts either take them further away from civilisation or around in circles. Do not under estimate the huge vastness and great distances of our Western Australian outback.

In a vehicle

If in a vehicle stay with or near your vehicle as it is a source of shelter and water [provided there are no chemical additives in the radiator]. Also it is easier for search parties to locate a vehicle than to locate a solitary human wandering around somewhere in the bush.

If you have to leave your vehicle temporarily to search for food or water mark your trail on the ground with sticks or stones so you can find your way back. Otherwise you may find it hard to locate your vehicle once it is out of sight. Only walk in the cool part of the day to minimise fluid loss and exposure to the sun.

On foot

If on foot once you decide you are lost consult your map and use it in conjunction with your recollection of the country you have traversed to try to identify a feature.

You can retrace your route to your last known position, or you can make for higher ground in an attempt to fix your position.

If you are operating with a pre-set escape route and all attempts to fix your position have failed then you should proceed on the bearing to safety.

If none of the above options apply then you should stay where you are, set up camp and wait for rescue.

ELECTRONIC SAFETY AIDS

There are many aids available to the outback traveller and it is worth considering these when planning for outback travel both on foot and by vehicle.

Radio Communications

For close range communication between vehicles a citizen band UHF or VHF radio may be used, however for long-range radio communication a HF radio is essential, these can be hired from communications suppliers at reasonable rates. Whilst travelling in the outback it is good practice to set up a communication schedule with the Royal Flying Doctor Service and contact them daily advising them who you are and where you are. Some HF radios also have an emergency beacon to contact the RFDS fitted.

Satellite/Digital Telephone Communications

It is now possible to ensure telephone communications in the outback with the introduction of a system of digital telephones that allow the user to call on his/her digital phone and be connected to a satellite system with no time delay if in an area not covered by a digital network. This system has a saturation system of satellites that download to ground stations and ensure instantaneous voice communication with no time delay between sending and receiving. The Royal Flying Doctor Service has a toll-free emergency Satellite Telephone number that should be known and recorded as part of your trip plan.

Position Indicator Beacons [EPIRB]

There are several rescue instruments available for the purpose of signalling for assistance, these include different types of rescue beacons. Travellers in isolated or outback areas should seriously consider their use. They can be hired from commercial outlets.

Satellite Navigation Systems [GPS]

Global positioning systems are available in Western Australia for purchase or hire. These are a hand held system that allow you to find your exact position. They also allow you to plan routes and navigate by giving you a read out of your exact heading and speed over the ground. Even though the cost may be a factor these units are of obvious value to off road travellers, particularly when travelling through unfamiliar territory.

Note:

Due to the technical nature of GPS, users are advised to ensure they understand their operation. Map suppliers should be consulted to ensure that maps used are compatible, as not all maps [particularly older ones] use the grid system used by GPS.

EMERGENCY SIGNALS

The following methods can be used to indicate your position.

Fires

A smoking fire will aid searchers, both in daylight hours and at night. Extreme care should be taken when lighting signal fires as some have got out of hand to the extent of causing major bush fires further endangering survivors and searchers.

Whistle Signals

Distress signal by lost party	three	3 blasts together, regularly spaced
Searchers looking for lost party	one	1 blast at regular intervals
Acknowledgement of distress signal	two	2 blasts repeated regularly
Recall signal for search parties	four	4 blasts

Gun Shots and Torch Flashes

When using gunshots or torch flashes the signals are the same as whistle signals. Remember that guns should be discharged into soft ground, never into the air.

WAPA Signalling Mirrors

These signalling mirrors are 75mm x 50mm x 6mm, made of glass and backed with canvas tape to improve durability. They can be improvised by removing wing and rear vision mirrors from vehicles, using the mirror on orienteering compasses [if fitted], the mirrors from make-up kits or using foil from survival kits if you do not have a survival mirror or heliograph.

If no aircraft or rescue vehicle is visible, continue sweeping the sky and/or horizon as mirror flashes can be seen for many kilometres, even in hazy weather.

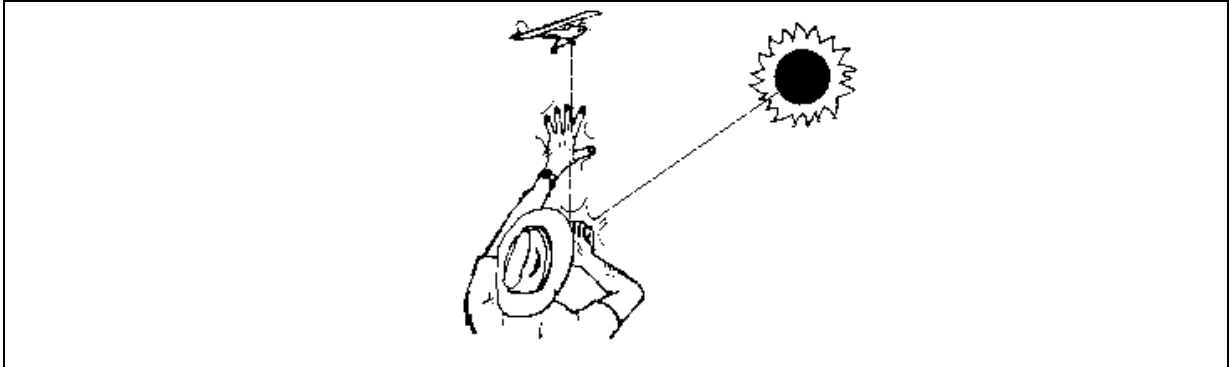

Signalling Using WAPA Signalling Mirror

Survival Signalling Mirrors

These are available commercially and are quite small at 7.5cm x 5cm x 5mm, they are made of laminated glass or polycarbonate with a sighting hole containing a special reflectorised screen that directs a beam of sunlight onto a target. They are operated by –

1. Holding the mirror in one hand and directing sunlight onto your other hand.
2. Slowly bring the mirror up to eye level and look through the sighting hole. You will see a bright light spot. This is the aim indicator.
3. Hold the mirror close to your eye and slowly turn and manipulate it so the bright light spot [aim indicator] is on the target [aircraft, helicopter or distant search party].

Ground to Air Code

This is a universal code used to communicate with rescue aircraft. The figures should be approximately eight to nine metres in length and contrasting material such as rocks; logs or brush should be used. Trenches in sand can also be used to throw a shadow.

Ground to air visual code for use by survivors

The ground to air code that should be used by survivors is as follows; If in doubt use international symbol - 'SOS'

- V** – Require assistance
- X** – Require medical assistance
- ↑** - Proceeding in this direction
- Y** - Yes or affirmative
- N** - No or negative

Actions by Aircraft

- If your signals have been seen and understood the aircraft will rock from side to side in daylight hours and flash landing or navigation lights twice at night.
- Lack of the above signals indicates that the message has not been understood

Rescue Helicopter

Never approach a helicopter on the ground. Position yourself in front but well away from the helicopter, in view of the pilot and wait until approached by a crew-person.

BUSHWALKING SAFETY

Route plans

All members of the group should have a copy of the route plan and should be aware of any hazardous sections and ensure all maps are current and accurate

Leaders

If there is a leader appointed they should be competent in all skills required and assistant leaders must be experienced enough to safely care for the party should something unforeseen happen to the leader. Both should be conversant with the area.

Medical limitations

Prior to setting off it is essential that the leader of any group be made aware of any medical condition or any limiting personal factors affecting any member of the group.

Actions-on

In the interests of safety 'actions-on' should be set for all foreseeable emergency situations and all members of the group must know the agreed emergency procedures. It is a good idea for an individual emergency procedure card to be printed and issued to each person.

Escape Routes

Escape routes should be set prior to departure and must be known and written down by all members of the group.

Notifications

Notifications need to be posted prior to departure and cancelled on return. Police in the area of the walk should be notified [it is good practice to discuss your plans with them].

Walking Formation

In the interest of group safety a system of walking in single file through the bush is recommended rather than having the group walk scattered over a large area where should a walker be separated from the group he will most likely not be missed until the group stops at the end of the day.

If the group walks in an orderly line then there is less chance of an individual becoming isolated.

Navigation tasks should be divided between group members and tasks interchanged regularly in order to increase team spirit and skill practice. Roles within the bushwalking formation should be -

Position and role in walking formation

Listed below are the roles of walkers when walking in single file. Numbers are from the front to the rear –

1. Responsible for carrying the compass and direction of travel
2. Carries the map and responsible for map-to-ground observations
3. Records the distance travelled by counting paces
4. Responsible for communications and navigation log
5. Uses the GPS if carried to verify position
6. Carries first aid kit and performs the duties of 'whip' [always last in line]

BUSHFIRE SURVIVAL

Every year in Australia there are serious bushfires in which people are caught and sometimes die. In some cases these deaths could have been prevented if the people involved had not panicked and had a basic knowledge of bushfire survival. Here are some basic rules.

Avoid

Take immediate action to leave an area as soon as you become aware of the fire. Every minute may be critical especially if on foot.

Panic

Causes energy loss and poor judgement, act calmly and do not run.

Breathing

When the smoke is dense the air closest the ground will be cool and fresh.

Heat

Radiated heat is the real danger; use anything to avoid it such as culverts, running streams, ponds, rocks or depressions.

Flame Fronts

Do not attempt to run through flame fronts. Always move downhill from a fire as fires travel faster uphill. Avoid dense areas with heavy fuel such as swamps or creeks.

Critical Periods

When you have no possible escape you should lie on the ground [bare ground, in a rut or behind a log or rocks] or bury yourself and stay put.

Clothing

When you realise that you are in danger from a bush fire cover as much exposed skin as you can with any clothing available. Do not use nylon clothing.

If your clothes catch fire do not run as this feeds air to the fire, roll on the ground or use items such as blankets to smother the fire.

In a vehicle

Many tragedies have occurred because people left the safety of their vehicles and tried to flee from a fire. Your vehicle will provide much protection from radiated heat.

Park the vehicle in a clear area away from heavy fuels; protect yourself from radiated heat with blankets, towels, coats, etc. Close all windows, doors and vents. Leave the hazard lights on, leave the engine running. Turn the air-conditioning on, set to re-cycle.

Note:

Remain in the vehicle as long as possible. Exit the vehicle on the lee side avoiding hot door handles, etc.

Radio Communications

CITIZEN BAND RADIO

The Citizen Band Radio Service [CBRS] is a two-way, short distance, voice communications service that can be used by any person in Australia. CB radios provide a cheap and reliable means of communications.

The service operates in two distinct frequency bands - the High Frequency [HF] band [26.965 – 27.405 MHz] and the Ultra High Frequency [UHF] band [476.425 – 477.400 MHz]

The service is for public access and is available to everyone and as a private operator no licence or fees are required.

There are specific calling channels for CB operators in both frequencies. Channel 11 [27.085MHz] & channel 16 [27.155MHz] in HF band and channel 11 [476.675MHz] in the UHF band. These are call channels and once contact has been made conversations should be continued on another separate channel, allowing the call channels to remain free for other users. If you are travelling in a convoy it makes good sense to settle on a usual ‘working’ channel.

OPERATING PROCEDURES

When operating your CB radio following the guidelines set out below will assist in your transmission being received and maintenance of the mandatory standards specified for radio users by the Australian Communications Authority being maintained.

- Listen before transmitting to ensure that the channel is not already in use.
- Use call signs, of those stations you want and your own.
- Keep conversations brief and to the point. Know what you are going to say before you start your transmission
- Use the word “OVER” at the end of each transmission. This indicates you are waiting for a response.
- Use the word “OUT” at the end of communications to indicate to other stations that you have finished and the channel is free.
- Do not respond to a call not intended for your station, thus keeping the channel free of unnecessary congestion.
- Use appropriate language. Your transmissions will be heard by anyone with a radio tuned onto your channel.
- Speak clearly and slowly, holding the microphone 5-8cm away from the mouth. Use a normal speaking voice, there is no need to shout.
- Use the phonetic alphabet when communications are difficult and accuracy is important.

Phonetic Alphabet

Using the phonetic alphabet when communications are difficult and accuracy is important will assist you; the phonetic alphabet consists of –

A Alpha	F Foxtrot	K Kilo	P Papa	U Uniform
B Bravo	G Golf	L Lima	Q Quebec	V Victor
C Charlie	H Hotel	M Mike	R Romeo	W Whiskey
D Delta	I India	N November	S Sierra	X X-ray
E Echo	J Juliet	O Oscar	T Tango	Y Yankee
				Z Zulu

Parts of a transmission

- CALLSIGN - Of station called
- THIS IS - Proword
- CALLSIGN - Of station calling
- TEXT - Message contents
- ENDING - Proword e.g. “OUT”

Prowords

Prowords are words that are commonly used and accepted when making transmissions. They are designed to assist in keeping transmissions brief and conveying meaning in a single word or short phrase. Common prowords are listed below –

Proword	Meaning
Correct	You are correct
Correction	An error has been made and the correct message will be sent
I say again	Used when repeating all or part of a message
I spell	Used to indicate that you are about to spell the next word phonetically
Mayday	A distress signal not normally used in land communications and only used in an emergency
Out	Transmission has ended and a reply is not required
Over	Transmission has ended and a reply is expected
Read back	Receiving callsign is to repeat the message back to sender. This assists in showing message was understood.
Roger	Message received and understood
Say again	Repeat your entire message. Used when the message is not understood.
Send	Ready to receive a message
Sitrep	Situation report
Verify	Used when repeating part of a message you want clarified
Wait	Indicating a pause is required in transmission

EMERGENCY RADIO PROCEDURES

In an emergency situation where you require assistance, specific channels are set aside for broadcast. These channels are -

Channel	Frequency	Band
9	27.065MHz	HF
5	476.525MHz	UHF
35	477.275MHz	UHF

If your radio has the ability these emergency channels should be programmed into your set for easy access. These channels are monitored on a 24-hour basis by voluntary groups to assist in contacting the appropriate emergency service on your behalf.

If you have had no formal radio training the following broadcast transmission guidelines will assist in obtaining assistance -

Send - AB123 [or any station] This is [your call sign if you know it or your name]
Urgent message, calling any station, Urgent message - Over.

Reply - [Await reply from monitoring group] ACRM Base receiving, send. Over.

Send - AB123 Urgent message
Our location is [your position. From GPS if possible]; and
Nature of emergency, - Over

Reply - ACRM or monitoring agency will assist and guide you from here.

Note:

It is a good idea to teach all persons in your group how to operate your radio, advise them to stay calm and to speak slowly and clearly.

Creek & River Crossings

The question of crossing creeks and rivers is a vexed one and one that usually results in people avoiding them because of the inherent danger. It is possible in a survival situation however that you may have no option but to cross a creek or waterway to make your way to safety.

Note:

Under no circumstances should you cross an expanse of water that is deeper than the groin level of the shortest member of your party unless your survival depends on it.

If however you are required to cross a water hazard then there are accepted methods and safety procedures that can be applied.

APPRECIATIONS

Before proceeding, conduct a mental appreciation including reviewing the situation and making sure there are no alternatives and the crossing is unavoidable. Have a clear understanding of what is required by listing the factors that will help or hinder you. Consider the courses open to you and select the best course.

Considerations

If you decide you have to cross then there are several points you should consider, these include -

1. The shape of the water hazard to be crossed.
2. The composition of the ground underfoot.
3. Speed of flow of the water
4. Turbulence of the water.
5. Depth of water.
6. Temperature of the water.
7. Proposed entry and exit points.
8. Capabilities of members of your group.

Acceptable places to cross

There are two places where you should be safe during a crossing including shallow water [approximately thigh deep] over a gravel bed with accessible banks or a deep, slow flowing river that is not too wide.

Unacceptable places to cross

High and discoloured water with excessive flow, volume and river width.

Note:

Remember you will need to consider whether to cross or not, where to cross and which method to employ.

METHODS OF CROSSING CREEKS & RIVERS**Without aid**

Used when the water is below knee deep, the crossing should be in a diagonal downstream direction with the body parallel to the water flow. It is easier to maintain stability by ensuring one leg is upstream and one downstream. There is a danger that the rushing flow of water may cause your legs to buckle if you are facing downstream.

Single Pole Crossing

Used when the water is between the knee and groin in depth and the bottom is smooth with no obvious obstacles. The line of crossing should again be diagonal and downstream. The pole [2 m long x 5cm diameter] must be positioned on the upstream side. You should use the pole as a prop and you should lean in to it and walk in an arc until you have to stop and re-position the pole.

Note:

When using this method the body should remain parallel with the water flow.

Group Pole Crossing:

Used when the water is above groin height. This method provides mutual support and is suited to groups of 3 to 6 people. The crossing should again be diagonal and downstream in direction. The group should be parallel to the flow of water with the strongest person on the upstream end and the next strongest on the downstream end. The pole should be grasped with the upstream arm over and the downstream arm under.

Note:

If conditions are too difficult then retreat by walking backwards, do not try to turn around.

Swimming method

Used where the crossing is deep, the river is clear of debris and the current is not a problem. Waterproof your pack and use it as a flotation aid by holding it in front of you with one hand and using your other hand and legs to propel yourself forward.

Points to remember

The following points are listed to assist you in any water crossing –

1. Move side on to the current, take small steps and keep your eyes on the far bank.
2. Move diagonally across the river to lessen the effect of the current.
3. Never fight against the current or hold onto submerged logs or rocks.
4. Keep your boots on and avoid loose baggy clothing.
5. Wear thermal clothing next to the skin in cold conditions.
6. Waterproof your pack, loosen the shoulder straps and unfasten the waistband.

Bush First Aid

First Aid is what you can do to assist an injured person at the scene using only what is available under the prevailing circumstances. You may only have your two hands, remember that first aid does not rely on equipment. In some circumstances if there is nothing, or nothing more to be done, then first aid may mean going for assistance. Remember the patient is relying on you to go carefully to avoid accident or injury to yourself. Possibly the most important aspect of practical first aid, particularly in the bush, is clear logical thinking and the ability to improvise.

Factors

First aid is based on three factors -

1. Common sense
2. Knowledge
3. Technique

Order of urgency

- Ensuring first-aiders have regard for their own safety.
- Protection of the patient from further injury.
- Restoration of breathing and heart beat.

Further responsibilities

Stop bleeding, minimise pain, reassure the patient, seek further aid and if necessary transport the patient to hospital.

Making a diagnosis

Before you can commence rational treatment, a diagnosis must be made consisting of-

- **History** - the story of how the injury occurred
- **Symptoms** - what the patient feels
- **Signs** - what you can observe or find out by examination of the patient

CONDITIONS

Unconsciousness, shock, bleeding, pain and hysteria

Unconsciousness

There are many causes and these include, heart attack, drowning, electrocution, head injury, fainting and smoke inhalation. General treatment is the same -

1. Remove the patient from the cause or the cause from the patient
2. Examine the patient quickly
3. Commence cardio pulmonary resuscitation where necessary
4. Stop bleeding if necessary
5. Turn the patient on his/her side in the recovery position

Shock

Shock is a fall in blood pressure that, if unchecked results in irreversible changes in the body functions at cellular level resulting in death. ‘There is a point of no return’. The onset of shock is often delayed, such as when a person first starts bleeding. They may not be shocked, but if they go on bleeding [externally or internally] they will eventually become shocked. Prevention is extremely important because of the ease and subtlety with which a state of irreversibility can develop.

Causes of Shock

Shock is caused by the actual or relative reduction of intravascular volume where not enough blood is available for the heart to pump to vital organs, or the pressure is too low to be of use. Specific causes of shock include bleeding, burns through loss of fluid to damaged tissues, heart attack, painful injuries, fractures, fainting and blood loss at fracture site. Shock is also caused by disease and infection, heat stroke, fluid loss, salt loss, fatigue and vomiting.

Recognition of Shock

Cold and clammy, rapid feeble pulse, rapid shallow breathing, thirst, weakness, anxiety, restlessness, inability to speak and nausea

Treatment of Shock

Minimise fluid loss, raise the legs, protect from elements, maintain temperature, reassure, moisten lips and **do not** give alcohol.

BASIC LIFE SUPPORT

In the management of collapse it is important that no time is wasted. Immediately call for medical assistance, stay with the collapsed person and follow the steps as outlined below -

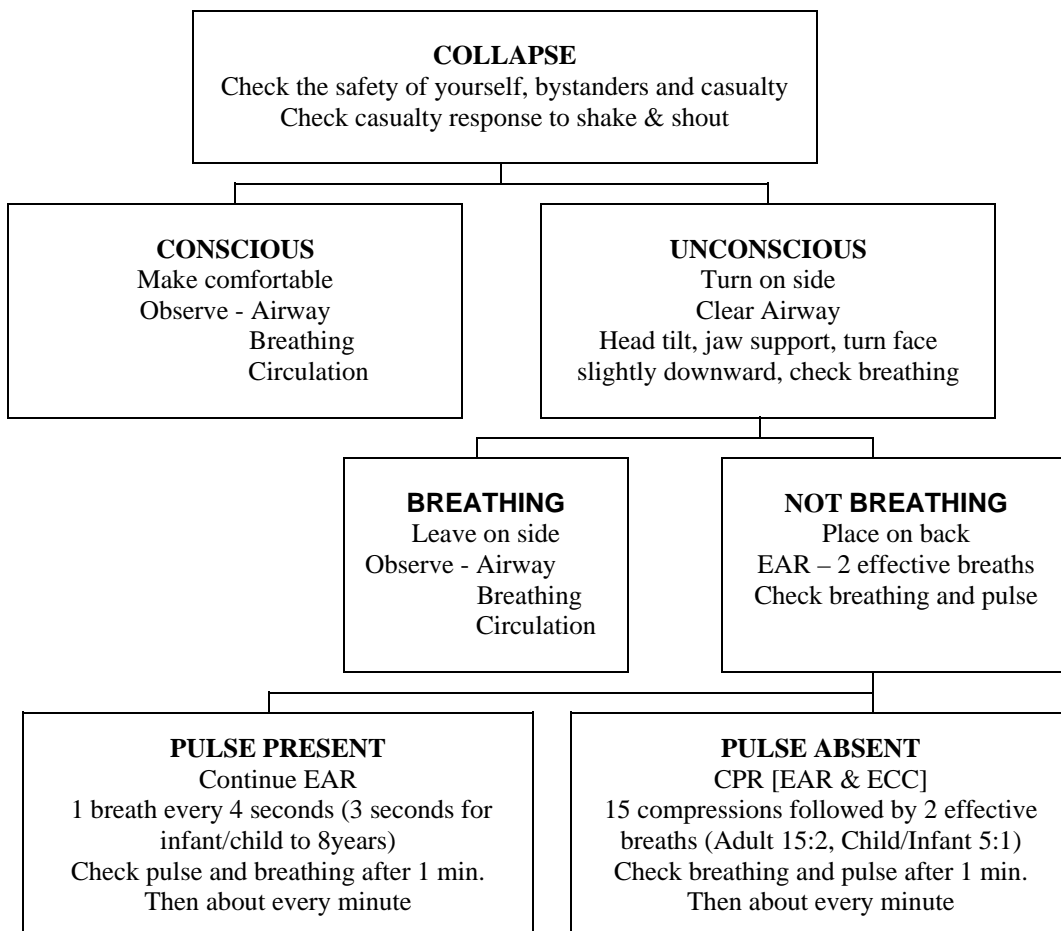

FRACTURES

The key to the treatment of fractures is immobilisation. A mobile fracture is painful, can cause internal bleeding, may become compound [break through the skin] and is a major cause of shock.

Treatment of Fractures

Assess the situation and see if you can immobilise the site, reduce or re-position [only reduce a fracture if you must] and then support [axial traction if necessary.]

Method of Immobilisation

- Fingers - strap the broken one to the adjacent finger
- Legs - strap legs together or splint
- Pelvis - strap legs together
- Upper arm - collar and cuff sling and bandage upper arm to chest
- Ribs - leave alone

Note:

If the patient faints with pain do not stop, reduce and splint the fracture

FRACTURES OF THE SPINE

Fractures of the spine are associated with large forces and may be complicated by damage to the spinal cord. Therefore to avoid permanent damage, careful protective handling aimed at minimising spinal cord damage is essential.

Signs and Symptoms

These may range from severe pain to loss of sensations and lack of control over limbs.

Treatment

The aim of treatment is to prevent farther damage by immobilising the spine. If the patient should be immobilised do so by strapping the legs together, maintaining body position with improvised padding and keeping the head straight and in extension to ensure an open airway.

SPRAINS

Sprains involve the abnormal stretching or the partial tearing of the supporting ligaments of any joint, ankles are the most common in outdoor activities.

Diagnosis

Pain, swelling, tenderness and bruising but still able to use the joint or limb.

Treatment

In bush walking situations it may be better not to remove the boot if it comes above the ankle. Otherwise contrast bathing if available [alternate bathing in warm and cold water, 5 minutes at a time] or immerse in cold water for 15 minutes then bandage.

HEAD INJURY

If a patient is unconscious and has not obviously been electrocuted or drowned then you should think of head injury, remember there may be no signs. Bleeding from the nose, mouth or ears may indicate a fracture of the skull. If a patient who has been unconscious recovers and then loses consciousness again you may assume head injury.

Treatment

Treatment is very simple and general first aid principles apply. Turn into the recovery position and transport to hospital.

BURNS AND SCALDS

- 1st degree - superficial burns such as sunburn
- 2nd degree - partial thickness burns where blisters are present
- 3rd degree - full thickness with charred skin or white skin with a red edge

Rule of 9's

The area of burn is important once the burn has been diagnosed as 2nd degree or worse. The burnt area can be assessed as a percentage of the body surface using the following table -

Arms	9% x 2	18%
Lower leg	9% x 2	18%
Upper leg	9% x 2	18%
Stomach	9% x 1	9%
Buttocks	9% x 1	9%
Chest	9% x 1	9%
Back	9% x 1	9%
Head	18% x 1	18%
Groin	1% x 1	1%

Significant fluid loss occurs in tissues damaged by burns. A person sustaining partial thickness burns to 5% or more of their body will require hospitalisation. An area of 9% or more will require hospitalisation and intravenous fluids.

Full thickness burns to 2½% or more of the body area will require hospitalisation while full thickness burns to 5% or more will require hospitalisation and intravenous fluid.

Treatment

Cold water should be used to irrigate any burn of any thickness. If possible the burnt part should be immersed in water for twenty minutes, [not ice].

The use of an antibiotic cream or Betadine ointment is useful to prevent infection because infection will convert a partial thickness burn into a full thickness burn.

Note:

Do not use butter as this will introduce bacteria and leave any blisters intact.

BLEEDING

Blood flows through the circulatory system using arteries and veins, if there is a break or a hole in an artery or vein then bleeding will occur.

Treatment

Simply plug the hole, do not worry about whether it is arterial or venous bleeding. Remember, 'bleeding is bleeding'. First wipe away any blood or remove the clothing so you can see where the bleeding is coming from. Next hold, press or apply pressure with a pad and bandage the source of the bleeding. Then elevate the bleeding site if practical.

If there is much bleeding the patient will develop shock quickly.

Note:

Tourniquets are generally a big 'no - no' and are only to be used if you cannot stop the bleeding in any other way. Tourniquets do cause more damage and the limb may be lost altogether but use common sense, if the limb is severed use a tourniquet first as you cannot do any further damage to a limb that is not there.

PAIN

There are many causes of pain. They may be uncomfortable, incapacitating or minor injuries [stings, bites, splinters, blisters, etc] remove the cause and/or treat the injury.

HYSTERIA

Defined as irrational behaviour caused by fear or anxiety such as claustrophobia when caving, freezing when climbing a rock face or crossing a stream by way of a log bridge.

Treatment

Reassure and secure the patient from danger. This may mean immobilising him/her or roping them to a rock face or whatever. Retrieve the patient by leading or removing him/her off the offending environment to a secure position.

ASPHYXIA

Asphyxia is a state of unconsciousness induced by lack of air due to drowning, smoke inhalation, choking [foreign body in throat], foul air or gas, suffocation by sand or paralysis of respiratory muscles as in blue ringed octopus bites or cone shell stings.

Treatment

Begin cardio pulmonary resuscitation [CPR] and keep going until help arrives, remember this may be 1 or 2 hours or more.

Note:

Marine stings, cone shell and blue ringed octopus victims may start breathing by themselves some considerable time after lapsing into unconsciousness.

INSECT BITES

The only recorded fatal bites are from ticks [spiders are not insects]. Red-back spiders and scorpions cause pain, not death. The other major problem is allergy and an anaphylactic [severe allergic] reaction may occur in some people.

Treatment

Insects inject their venom below the skin but agents such as alcohol, ammonia and methylated spirits may be useful as counter irritants.

Bee-stings have a poison sac attached to the sting and the sting being barbed will often remain in the skin. It should be removed with the blade of a knife or the edge of a piece of paper, not between the fingers as this will squeeze the sac and inject more venom.

Ticks should be removed using alcohol to irritate and then pulling off using tweezers or tick-pliers on either side of the mouth part. Do not hold by the body and pull it off as this may leave mouth parts embedded in the skin. Wash the bite area with soap and water

Prevention

Simple self protection measures can be used to minimise contact including avoiding outdoor activity at dawn and dusk, wearing long sleeved, light coloured loose clothing and not using perfume, cologne or after shave. Use insect repellents with a DEET content of between 15 – 20% on exposed skin.

SNAKE BITE

90% of snakebites in Australia are at the ankle or below, 8% occur on the hands and 2% elsewhere on the body. You should assume all snakes are venomous and always believe someone when they say they have been bitten, even though you may not see any puncture marks. Since 1983 thirty-nine deaths have been attributed to snakebite in Western Australia.

Signs and Symptoms

Puncture marks, slight bruising, redness and swelling, nausea, sweating, diarrhoea, pains in the chest and double vision.

Treatment

1. Apply broad firm elastic pressure bandage over bite and as much of the limb as possible. After covering bite continue bandaging up the limb and if sufficient bandage back down again.
2. Immobilise limb with splint. On leg, splint in straight position. On forearm, splint to elbow and support arm in sling.
3. Keep victim still. Bring transport to victim and convey to nearest hospital.
4. For bites on trunk of body or face, apply local pressure only with flat of hand.

Note:

Do not wash venom from bite site. Bandages and splints should be left on and removed only by a doctor.

Prevention

The best guard against snakebite is protection. If you wear above ankle boots and/or thick socks and long trousers you are less likely to be bitten by anything. Use gloves when collecting firewood, never put your hand under anything without first rolling it over with your boot, watch where you put your feet when walking and never step over logs, always step up on them and then step down.

CUTS AND ABRASIONS

Treatment

Clean with water and apply antiseptic cream or solution as this may prevent infection later. Cover with band-aid, dressing or bandage to avoid further contamination of the wound.

BLISTERS

Treatment

Leave them intact, if you make a hole for the fluid or blood to get out you have made a hole for germs to get in. Pad away from the area causing pressure using band-aids, felt strips, a felt pad with a hole cut in it or a specially designed blister dressing

Note:

Do not put the dressing directly on the blister unless it is specifically designed for this purpose as this increases pressure.

SPLINTERS

Treatment

The skin is very elastic therefore a splinter stretches the skin as it goes in and the skin then closes over it or at least grips the splinter. A small [painless] superficial cut with a scalpel at the site of entry is helpful in removing the splinter.

CARE OF FEET

Your feet get you wherever you are going, especially on bush walks, it is therefore important to take care of them. Wear suitable footwear, preferably hiking boots or shoes with a heavy sole, hygiene is important so wash feet daily and apply foot powder

CASUALTY ACTION

If you are on foot in a group and a member sustains an injury preventing him/her being carried out then a team consisting of at least two people should remain with the casualty.

A second team of no less than two people should continue to the next organised check point or aid station with a written casualty report containing –

- Designation of the group
- The names of all group members.
- Name of casualty
- The nature of the problem or injury.
- Assistance required.
- Map details and the location of the casualty.
- The food and water state of the group.

HYPOTHERMIA

Hypothermia is the lowering of the body core temperature.

Factors Influencing Development

These include -

- Low air temperature.
- Conditions of high wind chill.
- Unsuitable clothing – ineffective insulation, unprotected head.
- Wet clothing – rain, sweat.
- Level of exercise - sustained exercise and hunger causes fatigue.
- Body build – thin people with low body fat are more susceptible.
- Level of fitness/health - people with underlying disease, illness or injury are at risk.
- Inadequate equipment – poor protection from cold, wind and wet.
- Age – elderly, frail at higher risk.

Recognition Of Mild Hypothermia

- Skin feels cold.
- Skin looks blue or livid [mottled].
- Patient shivers, feels cold and says so.

Recognition Of Severe Hypothermia

- Skin is cold and mottled.
- No shivering, [shivering response has failed].
- Irrational behaviour and speech, may be uncooperative.
- May be unconscious, [if so is near death].

Treatment

Re-warm critical areas including the chest, neck and head by body-to-body contact with two or more persons or by placing heated objects such as hot rocks or water bottles filled with hot water and wrapped in towels to prevent burning the skin about the areas mentioned, particularly the sides of the chest.

Several people, if possible should breathe warm air near the patient's mouth to warm the air breathed into the lungs.

If conscious, re-hydrate with warm, non-alcoholic drinks. If unconscious, transport to hospital and leave the patient cold while transporting, insulate with blankets to prevent further heat loss.

Note:

A victim of hypothermia can be resuscitated after a much longer period of technical death, when no pulse or breathing can be detected than a patient at normal temperature.

FROST BITE**Recognition**

Pain in extremities with failure of skin sensation, the skin does not move freely over toes and knuckles.

Treatment

Do not thaw if likely to re-freeze, do not rub frozen parts. Thaw rapidly and completely in warm water [40° to 42°C]. Protect thawed regions, do not break any blisters and keep the whole body warm to promote circulation.

HYPERTHERMIA

Hyperthermia is Heat Stroke and may be fatal.

Factors Influencing Development

These include -

- High air temperature.
- Conditions of high humidity.
- Unsuitable clothing - reduces sweat evaporation.
- Level of exercise - sustained exercise causes internal heat generation.
- Body build - big, well-muscled or overweight people are more susceptible.
- Level of fitness - fit people have better blood flow to muscles and skin.
- Dehydration - reduces blood volume.
- Age - elderly at higher risk than young.
- Climate - acclimatisation to hot conditions reduces risk.

Recognition [In hot conditions]

- Skin feels hot and dry to the touch.
- Face is flushed.
- Rapid pulse at rest.
- Dizziness.
- Excessive fatigue.
- Lethargy, and no will to go on.
- Irrational behaviour.
- Cessation of sweating.

Treatment

Transfer to a cool, shaded location.

Immerse in cold water if possible, apply ice packs to the armpits and groin area if available and cool the skin by sponging with water or alcohol.

Concentrate on cooling head, neck and chest.

Keep the patient at rest and re-hydrate by giving frequent small amounts of cool fluids [not alcohol], to drink.

SALT DEPLETION

Recognition

Muscle cramps after sweating in hot conditions.

Treatment

Give oral fluids, preferably one of the commercially marketed balanced electrolyte replacements dissolved in water. Most of these are suitable and are aimed at the average amount of salt lost. They contain glucose and a mixture of sodium, potassium and chloride, which are the three main mineral electrolytes that people lose.

The cramps occur because of an imbalance between the electrolytes and the fluid levels in the muscle cells.

WAPA TEAM FIELD FIRST AID KIT

1 Pkt x 24, Panadol 500mg tablets	2 Probes splinter, double ended
1 Bandage, conforming 50mm	1 Bag x 12, Stainless steel safety pins
1 Bandage, conforming 75mm	1 Pair, Forceps blunt stainless
1 Bandage, crepe heavy	1 Pack, Dressings assorted shapes plastic
1 Roll, Dressing tape, zinc oxide 25cm x 5m	1 Dressing, non-adherent 7.5cm x 10cm
4 Swabs antiseptic, Betadine	1 Eye pad, 7.5cm x 6cm
6 Swabs antiseptic, Alcohol	1 Antiseptic steri tube 30ml
1 Stingose gel 25g	1 Burnshield dressing 10cm x 10cm
1 Pair, Scissors surgical 125mm	1 Digit burn dressing 25mm x 500mm
2 Saline steri tubes 10ml	1 Medical Box

Resuscitation Face Mask. Foil Rescue Blanket. Sanitary Napkins. Tampons. Small Plastic Garbage Bags. First Aid Notes. Notebook & Pencil. Disposable Gloves. Tissues. Petroleum Jelly. Insect Repellent [DEET -30%]. Sun-Block [SPF 30+].

WAPA FIELD HEADQUARTERS BASE FIRST AID KIT

1 Pack Sterile Gauze Swabs	5 Antiseptic Wipes
1 No.13 Wound Dressing	1 Tube Insect Bite/Sting Relief Gel
1 No.14 Wound Dressing	1 Tube Antiseptic Ointment
1 No.15 Wound Dressing	1 Bottle Antiseptic Solution
1 Roll Band-Aid Adhesive Dressing Strip	1 Container Antiseptic Powder
1 Pkt Band-Aid Adhesive Dressings	1 Pkt Paracetamol Tablets
1 Roll Waterproof Adhesive Tape [2.5cm]	1 Pkt Paracetamol Tablets With Codeine
5 Non Adherent Dressings [10cm]	1 Bottle Cough Medicine
1 Sterile Combine Dressing Pad	1 Pkt Medicated Throat Lozenges
2 Elastic Bandage [7.5cm]	1 Bottle Eye-Stream Irrigation Solution
2 Elastic Bandage [10cm]	1 Bottle Eye Drops
3 Calico Triangular Bandages	1 Bottle Ear Drops
3 Sterile Eye Pads	1 Pkt Antihistamine Tablets
3 Tullegras Sterile Dressings [10cm]	1 Pkt Anti Diarrhoea Tablets
1 Pkt Butterfly Wound Closures	1 Pkt Laxative Tablets
1 Pkt Cotton Buds	1 Pkt Electrolyte Replacement Powder
1 Pkt Cotton Balls	1 Bottle Oil Of Cloves
1 Pair Scissors	1 Pkt Antacid Tablets
1 Pair Tweezers	1 Bottle/Tube Liniment
1 Sterile Needle	1 Instant Ice Pack
1 Sterile Scalpel Blade	

Resuscitation Face Mask. Foil Rescue Blanket. Sanitary Napkins. Tampons. Small Plastic Garbage Bags. First Aid Notes. Notebook & Pencil. Large Kidney Dish. Disposable Gloves. Tissues. Safety Pins. Tick Removal Pliers. Insect Extractor Kit. Petroleum Jelly. Insect Repellent [DEET -30%]. Sun-Block [SPF 30+].

Note:

Those responsible for group first aid should have a current relevant first aid qualification. All treatments must be recorded. Personal medication should remain the responsibility of individuals.

ST JOHN AMBULANCE HIKERS FIRST AID PACK

1 Adhesive shapes, assorted 50pkt	1 Scissors, stainless steel
1 Adhesive tape [zinc oxide] 2.5cm x 5m	1 Forceps, stainless steel
1 Triangular bandage 110 x 110 x 155cm	3 Towels, disposable
1 Conforming bandage 5cm	2 Gloves disposable
2 Non-adherent dressing 10 x 10cm	3 Plastic bags, re-sealable
1 Wound dressing, No.14	1 Notepad and pencil
3 Gauze swabs 7.5 x 7.5cm	1 First Aid Quick Reference Guide
5 Safety pins	

Packed in a soft, green vinyl pouch designed to be worn on a belt

RED CROSS HIKING FIRST AID KIT

1 Contents list	2 Non-adhesive dressing 10 x 10cm
1 Adhesive tape, 2.5cm	1 Gloves, disposable
1 Scissors, blunt, sharp stainless steel	1 Pkt tissues, 10
1 Combine dressing, 90 x 200mm	5 Safety pins, 40mm
5 Adhesive dressing strips	1 Splinter forceps
1 Crepe bandage, 7.5cm	1 Normal saline, 30ml
1 Disposable foil blanket	1 Triangular bandage not less than 900mm
1 Eyewash, 30ml	1 Conforming bandage 5cm
1 Gauze bandage, 5cm	1 Wound dressing, No.14
1 Gauze bandage, 7.5cm	1 ARC First Aid Notes
3 Gauze swabs	1 Pencil and notepad
3 Individual plastic bags 150 x 200mm	

A red, water resistant nylon fold out soft pack with zippered inside compartments designed for organisations and individuals involved in outdoor activities

ACTIVITY-SPECIFIC FIRST AID KITS

A wide range of activity-specific first aid kits is available from St John Ambulance, Red Cross and outdoor suppliers to cope with outdoor recreation, adventure events and commercial 4WD and outback touring activities.

Most new first aid kits available today are self-contained, compact and lightweight and include a variety of first aid requirements. Basically there is a comprehensive range of first aid kits available to cope with emergency and first aid situations, which vary in price according to individual needs.

DEALING WITH DEATH

While it is an accepted fact that only a qualified medical practitioner can certify that a person is dead, and that treatment once started should be continued, there are occasions, particularly in remote areas where the casualty is dead and a decision must be made to start or stop treatment [as the case may be].

Signs of Death

- Fixed dilated pupils, not responding to resuscitation.
- Absence of spontaneous heart beat in spite of prolonged resuscitation.
- Rigor mortis [stiffening of the body] is a late but reliable sign of death.

Note:

Resuscitation should never be stopped when medical aid is imminent.

Dealing with a Dead Body

Whilst this may be an unpleasant topic it is a possibility that should be dealt with properly to avoid further stress among witnesses and address the problem in a manner to satisfy the law and to facilitate the later recovery of the body.

If on foot the group should not attempt to carry the body out with them and for purposes of morale should not split themselves up and have some of the group remain while others go for help. They should leave the body and walk out in a group.

Before doing this you should carry out the following procedure -

1. Get everybody in the group to take careful notes of the circumstances surrounding the death, as statements will be required for the coroner.
2. Wrap the body in a tent or ground sheet and firmly secure it with rocks etc., to protect it from animals and the elements.
3. Mark the spot and the trail out to allow easier location later.
4. On return to civilisation report the matter to the police.
5. Take possession of all valuables found on the deceased, have somebody witness them and give them to the Police when you are able.

Effects of Death on Others-

Watch for signs of shock [witness shock] in the party. At the very least there will be depression and distress that must be handled by the group before it leads to worse manifestations of stress and shock.

Land Navigation

Good map reading and land navigation is an essential requirement for bushwalkers and travellers in the outback. Maps enable users to find their way about the country; allow recognition of features and gives the user an understanding of the information given on the map allowing it to be related to the surrounding countryside. Maps also assist in the transmission of information.

MAP READING

Map reading is the extraction of information shown on the map; the relationship of the ground to the map and the map to the ground.

To make full use of a map, it is necessary to give and read grid references, to take bearings and to measure distances. The ability to use or read a map is called 'map craft'.

Reliability of maps

A map is a plan of the ground. Remember however, it is a plan of the ground at a certain date. If it is a long time since the map was produced or revised much may have changed. Towns grow, roads and railways are built and forests grow and are cut down. No map can be taken as being reliable except concerning the main physical features of the land. Even these may change slowly, as coastlines erode and in some places rivers may even change their courses.

Note:

It is very important to note the date the map was produced or revised and to judge its reliability accordingly.

Care of maps

Maps are valuable documents and the supply is never unlimited and they should be treated with care to prevent damage. Most damage to maps occurs when the users open them outdoors or in moving vehicles. There is always the chance of a slight breeze that might catch them and start small tears that can quickly spread.

To prevent tears, maps should be folded in such a way that any part can be referred to without having to be fully opened.

Once a map is folded, leave it folded, the detail at creases is sure to deteriorate but less than if the map was constantly unfolded and folded. Protect the folded map by placing it in a plastic map case when not in use.

Marginal information

Printed around the margin of the map is the information needed when the map is being used. This is referred to as Marginal Information. The type of information and the layout may differ from map to map.

Marginal Information Contents

On Australian maps a standard layout is adopted which gives the following information -

- **Sheet Name**
This is usually shown on the top centre of the map
- **Map Edition**
Usually located at the top right of the map
- **Sheet Number**
Maps are commonly referred to by sheet number, name and edition
- **Grid Reference Block**
Located at the bottom of the map and explains how to calculate a six figure grid reference
- **Legend Panel**
Located at the bottom of the map and gives a legend of the conventional signs used
- **Sheet History**
Located at the bottom of the map and gives production details
- **Index to Adjoining Sheets**
Located at the bottom the map
- **Magnetic Variation Information**
Located at the bottom of the map and gives the annual magnetic variation
- **Reliability Diagram**
This diagram does not appear on all maps, indicates the reliability of the information shown on a map
- **Representative Fraction**
A method of indicating the scale of the map. Usually located at the top left of the map.
- **Linear Scale**
Usually located at the bottom centre of the map

Conventional signs or legend

The mapmaker tries to show objects on the ground in the clearest possible way. These objects are not shown as they appear because they would be too small to recognise. Instead, simple symbols, referred to as conventional signs are used to indicate the objects. It is important to note that the centre base of the particular sign indicates the position of the object on the map.

Scale

The scale of a map is the relationship of the distance between two points on the map and the distance between the same two points on the ground.

Other types of maps

The information contained in this manual refers mainly to topographical maps. These maps present a complete and accurate picture of the ground by showing as much detail as their scale allows. It may be that accurate topographical maps are not available for a particular area and in this case an alternate map such as a road map, orthophotomap or air photograph will have to be used.

TERMS USED IN MAP READING

Some terms used in map reading to describe physical features include –

Basin

An area of reasonably level ground surrounded, or nearly surrounded by hills. It can also be the description used to depict the area drained by a river and its tributaries.

Breakaway

A small gully or low cliff line formed by erosion.

Crest

The highest part of a hill or mountain range. Specifically it is that line on a range of hills or mountains from which the ground slopes down in opposite directions.

Escarpment

The steep hillside formed by a sudden drop in the general ground level. This feature usually comes off a plateau.

Gorge

A deep ravine usually with very steep sides.

Knoll

A small knob-like hill.

Plateau

A tableland or generally level elevated region of considerable extent.

Ravine

A long, deep valley worn by a stream.

Re-entrant

A valley or ravine usually located between two spurs running inwards towards the hill or mountain-top.

Ridge

The line along a hill or range of hills or mountains from which the water flows in opposite directions. Sometimes it is described as the crest of a line of hills as it appears along the horizon.

Saddle

A depression between adjacent hill or mountain-tops; also called a col.

Spur

A minor feature generally in the form of a ridge running out from the hill or mountain.

Undulating ground

Ground that rises and falls gently.

Watershed

The line separating the water flowing into two different river systems.

NAVIGATION ROUTE PLAN

The importance of this document should not be underestimated. It can be in the form of a pre-prepared card or alternatively data written in a notebook.

The route plan expresses the intentions of the individual or group as to where they are going, how long it should take and what to do in the event of an emergency. If in a group it is important that everybody in a group has the same information.

The process of preparing a navigation route plan whereby members of the group are required to sit down and express their ideas and reach conclusions by consensus is an integral part of the teambuilding process. Such information should include -

Group details

Name of the group, the full names of all group members and whether any members of the group have any limiting medical conditions or are taking any medication.

Map details

The map title, edition number and scale should be recorded along with the magnetic variation applicable to the map. A sketch map should be drawn.

Route details

This should include Route numbers and the numbers of legs, which make up each route.

Waypoints

Details of each waypoint or landmark should include not only its position expressed as a six-figure grid reference but also a detailed description of that location.

Distance

The distance to be covered should be expressed in metres over the ground and an estimate of the number of paces required to cover the distance.

Heading

The grid bearing should be determined and the magnetic bearing to be walked should be calculated by applying the magnetic variation for the map to the grid bearing. Both bearings should be recorded.

Description of going

A 'section' of each leg must be drawn and entered in the route plan as a cross-sectional diagram supported by a description of the terrain, density of vegetation and any features that will be encountered.

Estimating journey time

Estimates of journey times should be calculated using Naismith's Rule. This rule is a guide only and can be modified with experience.

Escape routes and safety procedures

Escape routes should be pre-determined and should be entered along with details of any safety instructions.

Any safety instructions should be clear, concise and must be written in language that is clearly understood by members in an emergency.

WAPA NAVIGATION ROUTE PLAN CARD

Side 1 - Administration Details

SKETCH MAP

DETAILS

Name _____

Date _____

Exercise _____

Map _____

Scale _____

Team Number _____

Team members

1 _____

2 _____

3 _____

4 _____

5 _____

6 _____

7 _____

8 _____

9 _____

Do any team members have limiting medical conditions or disabilities *Yes* *No*

Side 2 - Navigation Information

Route & Leg	From	To	Distance <i>metres & paces</i>	Bearing <i>grid & magnetic</i>	Description Of Going <i>terrain, vegetation, features</i>	Estimated Time <i>minutes</i>	Escape Route & Safety Instructions

ESTIMATING JOURNEY TIME

Allow 1 hour for every 5000 m - easy going
 3000 m - scrambling
 1500 m - rough going

Add 1 hour for every 450 m - ascent
 900 m - descent
 5 hours walking [fatigue]

MAGNETIC VARIATION

GRID REFERENCES

Superimposed over the entire map are vertical and horizontal lines. These lines are known as grid lines and are numbered at each end. To assist the user when giving grid references these grid lines are defined as eastings and northings.

Eastings

The vertical grid lines that run from bottom to top [or south to north] and divide the map from west to east are commonly known as eastings. They are numbered from west to east.

Northings

The horizontal grid lines, which run from left to right [or west to east] and divide the map from south to north, are known as northings. They are numbered from south to north.

The squares that are formed where eastings and northings cross are known as grid squares.

Obtaining a 6 Figure Grid Reference

To obtain a 6 Figure Grid Reference of a position on a map with a scale of 1:25,000 or 1:50,000 use the relevant roamer scale located on the compass base plate.

Grid references should always begin with the letters GR to show that they are grid references and nothing else.

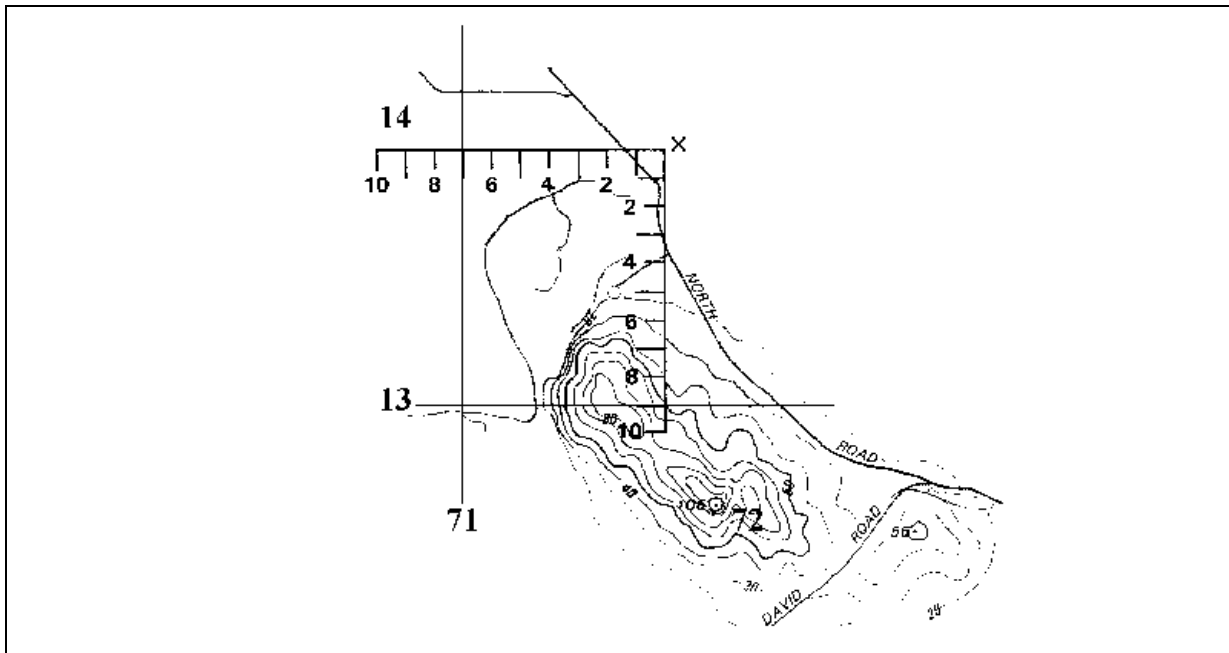

Six Figure Grid Reference [GR 717139]

MEASURING DISTANCES ON A MAP

To measure the distance in a straight line between two points on a map, lay the straight edge of a piece of paper against the two points and mark the distance on the paper.

Next lay the paper along the linear scale and with the right hand mark against one of the primary divisions and the left hand mark against the secondary divisions to the left of the zero point on the scale. The total distance is the distance to the right of zero, plus the distance to the left of zero.

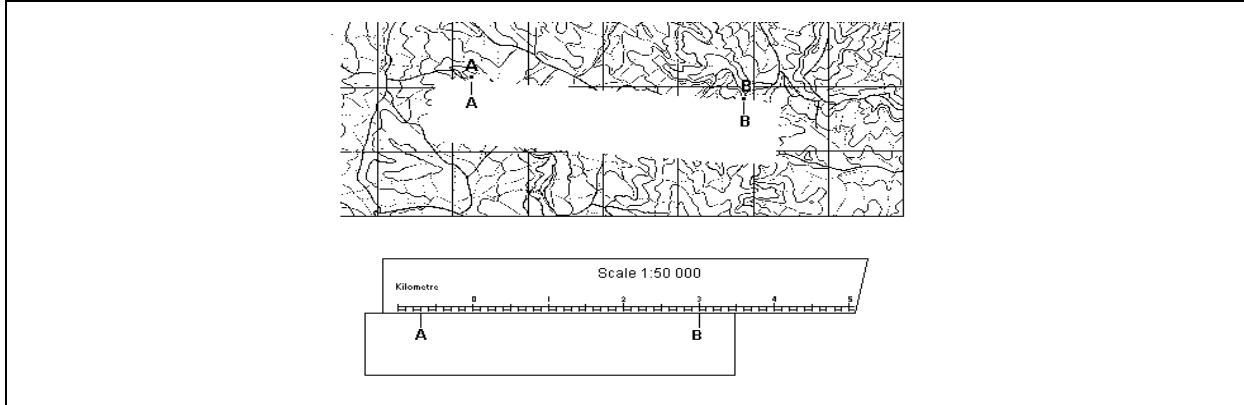

Measuring Distance [3.7 km or 3700 m]

PACING

Counting the number of paces you have taken and converting the number of paces to metres is the most reliable method of measuring distance travelled. Before setting off you will need to work out exactly how many paces you walk per 100m so you can convert your paces to metres. Pacing is done by counting the number of paces that you take and recording them using a pace counter or sheep counter [you can also tie a knot in a piece of cord or transfer a pebble from one pocket to another at each 100 paces]. Some walkers find it easier to count double paces, left foot to left foot, or right foot to right foot and double the total before converting to metres.

Note:

Most people on flat ground average 130 paces per 100 metres.

THE POINTS OF A COMPASS

North, East, South and West are the four cardinal points of the compass. There are, in all, 32 points of the compass, but only sixteen are normally used in map reading. These are the four cardinal points and twelve intermediate points.

The degree system

The points of the compass give an approximate indication of direction only, for greater accuracy the circle is divided into 360 degrees [000 or 360 being the north point].

The four cardinal points of the circle are each 90 degrees and therefore the East, South, West and North points are at 090, 180, 270 and 000/360 degrees respectively.

The four quadrants of the circle cover 90 degrees each and therefore the North-East, South-East, South-West and North-West quadrants are located between 000-090, 090-180, 180-270 and 270-000 degrees respectively.

Each degree is subdivided into 60 minutes and each minute into 60 seconds. Degrees are marked $^{\circ}$ minutes ' and seconds ''.

For practical purposes, readings to one degree are generally sufficient.

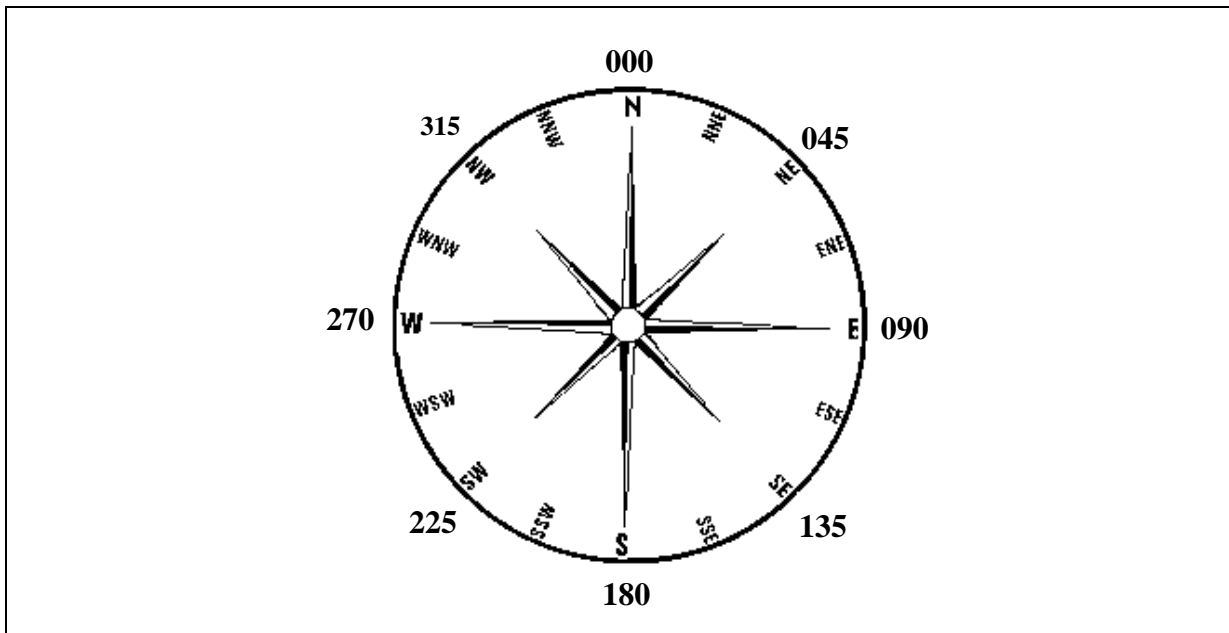

Points Of A Compass

Note:

Some organisations [Australian Army] measure angles in mils; 6,400 mils = 360°.

Bearings

The purpose of a bearing is to give an accurate indication of the direction of one point from another. A bearing is the angle, measured clockwise, that a line makes with a fixed zero line. The zero line is always taken to be north.

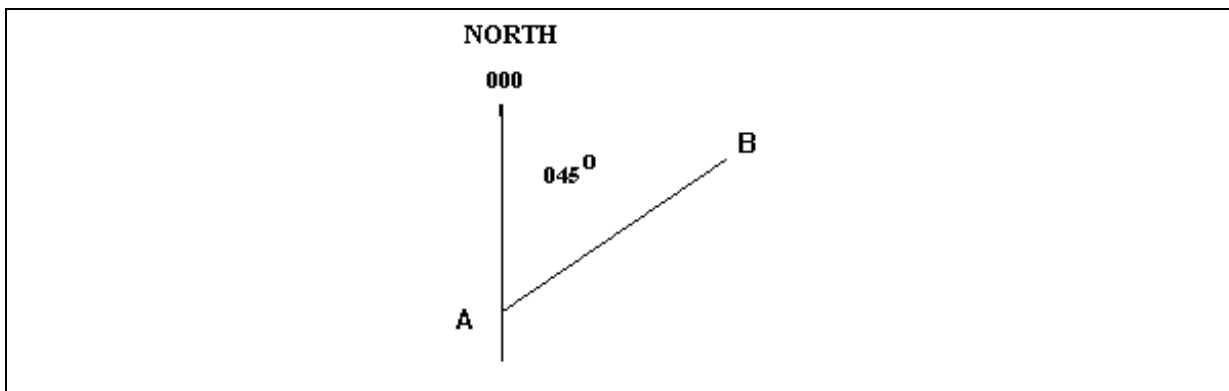

Measuring Bearings In Degrees [A - B = 045 degrees]

NORTH POINTS

In map reading, reference is made to three north points and each is detailed below:

True North

The earth spins on an axis that passes through the north and south poles. The North Pole is geographical north, or true north. Lines drawn from the North Pole to the South Pole are true north - south lines. True north is therefore the direction from any point on the earth's surface to the North Pole.

Magnetic North

To say a compass points north is only relatively true because a compass needle does not point to the North Pole. It points to a place in the far north of Canada known as the magnetic pole. The direction a compass needle points is known as magnetic north.

Grid North

The grid lines on a map do not lie true north and south, except along one standard meridian; elsewhere on the map they make an angle with the true north-south line. Since the grid lines are parallel and are drawn on the map it is very convenient to use them for drawing or measuring bearings. The direction of the north-south grid lines [eastings] is therefore known as grid north.

The Orienteering Compass

The orienteering compass was developed in the 1930's and are now used widely throughout the world by armed forces and many other organizations as a general-purpose compass. The most useful and durable of these have a base plate which makes the carrying of a protractor unnecessary. They also come complete with a cover which provides protection and a mirror which makes sighting objects easier as well as doubling as a signal mirror in emergencies.

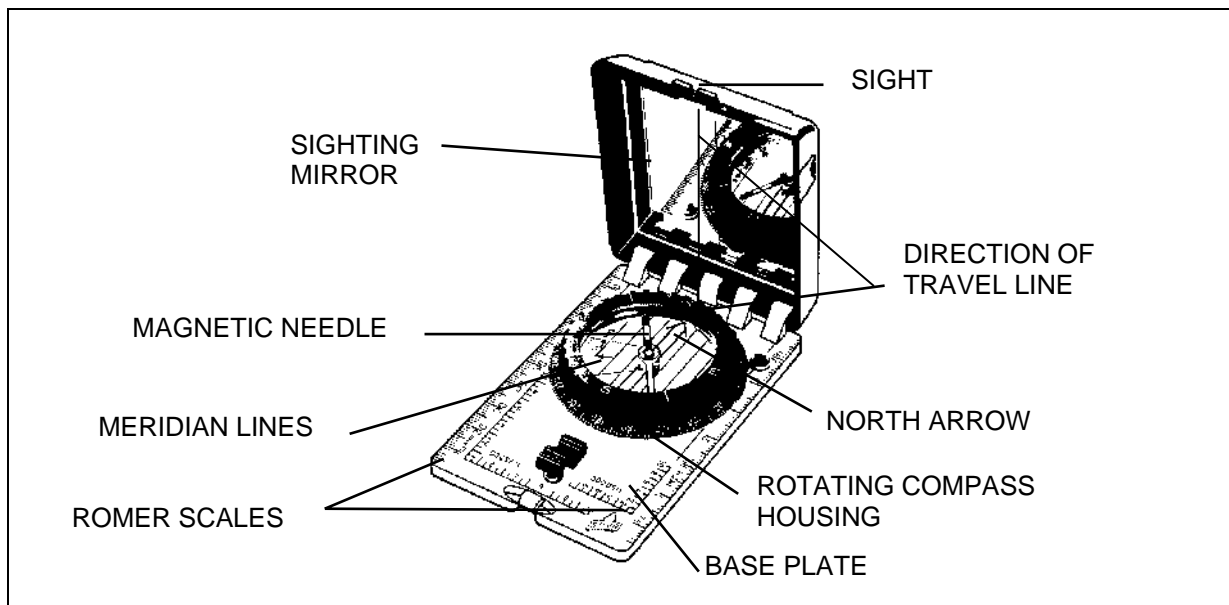

The Silva 15T Orienteering Compass [with cover and sighting mirror]

Use of the compass

Because of its unique design, the orienteering compass is very simple to use.

To take a grid bearing from a map

The procedure for calculating a grid bearing from a map is as follows –

1. Place the long edge of the compass plate along the desired bearing making sure that the direction of travel line on the compass plate points in the direction you wish to travel [if your compass has a sighting mirror at the front remember this coincides with the direction of travel line].
2. Turn the compass housing so that the meridian lines are parallel with the grid lines [eastings] on the map.
3. Read the grid bearing on the housing where the index line intersects it.

MAGNETIC VARIATION

The angle between the magnetic north line and the grid north line plus the annual change is known as magnetic variation or the grid-magnetic angle. The position of the magnetic pole is not fixed, it moves slightly from year to year. As a consequence, the direction of magnetic north, and therefore the magnetic variation also changes by a small amount each year. Though this change is not constant it can be forecast with sufficient accuracy over a number of years and details of the annual change are given in the marginal information as illustrated in the diagram.

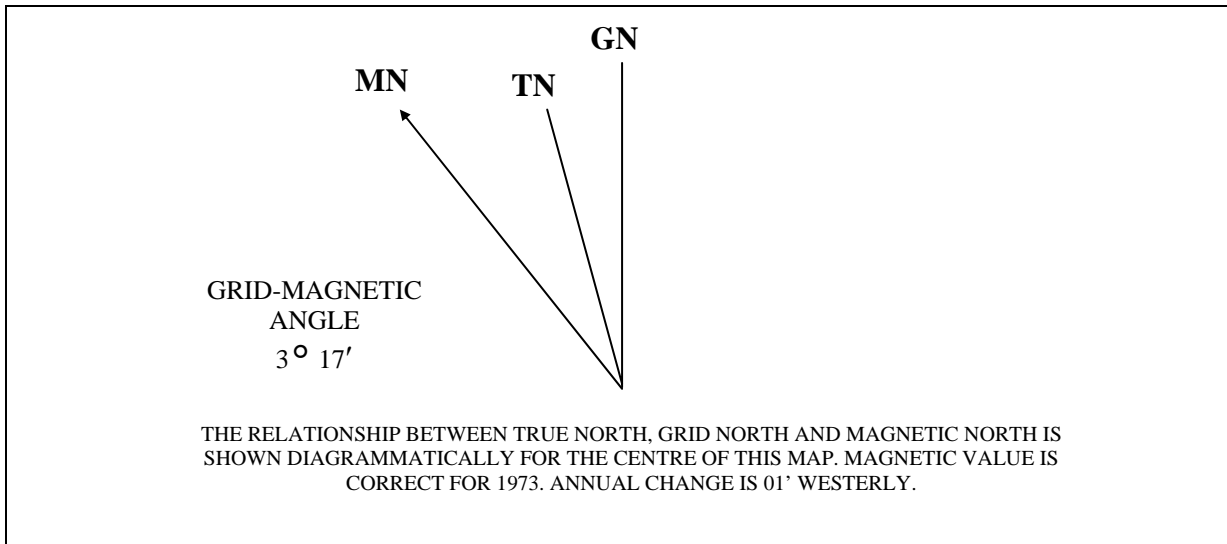

Example of magnetic variation diagram

Lines joining places with equal magnetic variation are known as isogonals. They do not themselves point in the direction of magnetic north. It might be expected that isogonals would follow a regular pattern but the earth's magnetic field at any point is affected by the land and mountain masses and the presence of metallic ores. Therefore, the isogonals are pulled out of shape and follow no regular pattern.

Adjusting grid bearings for variation

When the compass is used with a map or in conjunction with map bearings, an adjustment should be made to allow for the variation. This is especially important if there is considerable variation in your area or if accuracy is important. With one turn of the dial you can make the proper allowance of any variation. You must do this every time you wish to apply a variation to a bearing.

Find out the amount of variation in your area and then simply turn the dial as per the following rule-

- **From grid to magnetic**

If the variation works out to be west, then you will need to leave the compass on the map and turn the dial west the required number of degrees.

If the variation is east then turn the dial east.

- **From magnetic to grid**

Simply reverse the step.

CONTOURS

The usual way of showing the shape of the ground on modern maps is by contour lines. Contour lines make no attempt to give any visual illusion of relief and it is the failure to recognise this that causes difficulty to some people, in understanding them. The idea of a contour is very simple. It is an imaginary line drawn on a map, joining all places of equal height above sea level.

Height of Contours

On the map each contour is drawn at a specific height above sea level and the vertical distance between each is the same. The difference in height between contours is called the Vertical Interval and is shown in the marginal information on the map.

It is from the height and spacing of the contours that the shape of the ground is deduced and if necessary it can be calculated accurately. Some contour lines have the height above sea level printed at intervals along their length.

Another simple starting point in determining the general topography of an area is to use the flow of streams in conjunction with contours.

Contour Patterns

Each topographical feature such as a spur or a knoll is represented by its own particular contour pattern.

Important Points

The most important points to remember about contour patterns are –

- Contour lines close together indicate steep slopes
- Contour lines far apart indicate gentle slopes
- Evenly spaced contour lines indicate uniform slopes
- When the spacing of contour lines, reading from high to low, decreases, the slope is convex
- When the spacing of contour lines, reading from high to low, increases, the slope is concave

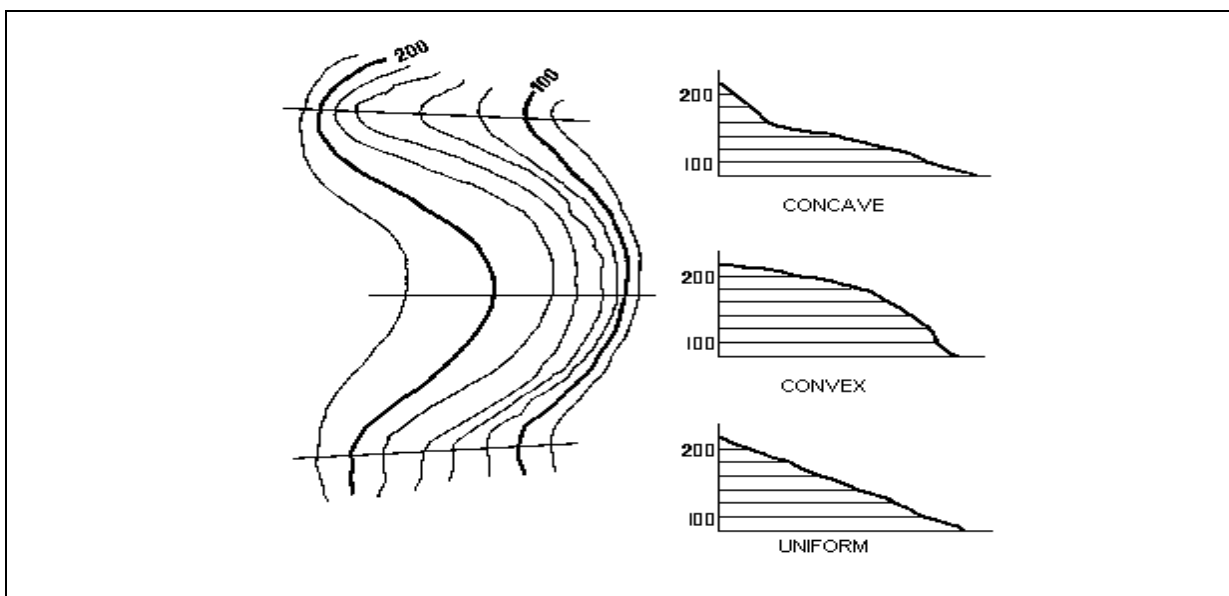

Contour Patterns

DRAWING A SECTION

To draw a section between two points on a map lay the edge of a piece of paper between the two points, mark it at these two points and again where the contours on the map cut this edge. Parallel to the edge of the paper draw lines representing heights of contours from highest to lowest on the route to be followed.

From each mark you have made on the edge of the paper drop a line to the corresponding height line and join these points to complete a section.

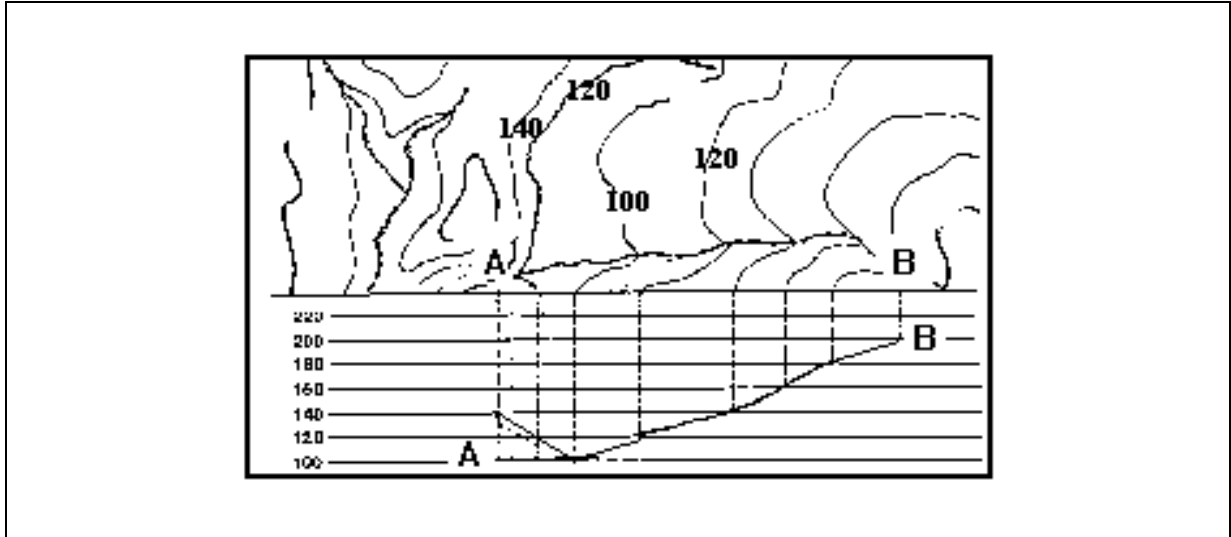

Drawing A Section

PREDICTING WALKING TIME

The following method known as ‘Naismith's Rule’ is a general rule for calculating trip times for an average walker with a medium weight pack.

- Allow 1 Hour for every -
5000 m Easy Going, 3000 m Scrambling or 1500 m Rough Going
- Add 1 Hour for every -
450 m Ascent, 900 m Descent and for every 5 Hours walking to cope with fatigue

SETTING THE COMPASS TO WALK ON A MAGNETIC BEARING

The following procedure should be followed when setting the compass to walk on a magnetic bearing -

1. Set the magnetic bearing on the compass by rotating the compass housing until the required bearing is in line with the index line on the compass plate.
2. Holding the compass flat in the palm of the hand turn around until the red end of the compass needle points to the north mark on the compass housing and is parallel to the meridian lines.
3. The direction arrow now points along the required magnetic bearing.

TO TAKE A MAGNETIC BEARING

The procedure for taking magnetic bearings to an object is detailed below –

1. Hold the compass with the direction arrow pointing to the object.
2. Rotate the compass housing until the red arrow of the meridian lines is directly beneath the red [north] end of the compass needle.
3. Read the magnetic bearing on the housing where the index line intersects it.

BACK BEARINGS

Unlike most other types of compasses there is no requirement to calculate back bearings with the orienteering compass. Simply turn around to face approximately the direction travelled along and reverse the compass so that the direction arrow is towards the user. Orient the compass by turning the whole body until the red end of the compass needle points to the north point on the housing and travel in the direction in which the rear of the compass plate faces.

ALTERING DIRECTION TO AVOID AN OBSTACLE

There may be occasions when it will be necessary to alter the direction of travel to avoid a major obstacle. This is best done by travelling around the obstacle using a series of right angles. With the orienteering compass this can be done without any alterations to the original compass setting simply by taking advantage of the right angles of the compass plate.

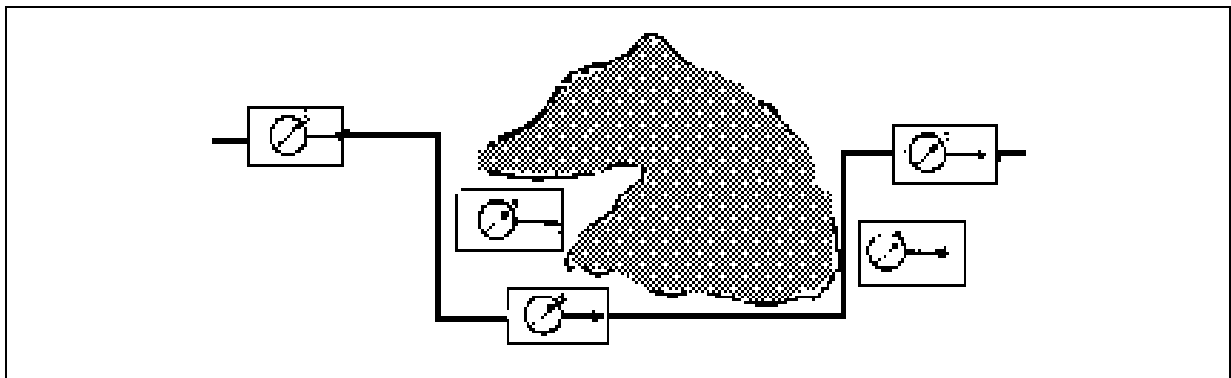

Altering direction using the base plate of a compass

COMPASS ERRORS

When using a magnetic compass, the user should be aware of the two main causes of variation in compass readings:

Individual Compass Error

Each compass has its individual variation that is it does not point exactly to magnetic north, the compass needle itself may not be quite true with the markings on the card and slight divergences may be caused in other ways.

The error may be negligible or comparatively large and therefore it is important to have compasses checked regularly. Any known error should be noted on the compass and when readings are taken allowance must be made for the individual variation.

Local Magnetic Attraction

Local magnetic attraction is due to the presence of any iron ore nearby. The compass is a delicate instrument and quite small quantities of iron have a surprisingly large effect on its behaviour.

A wristwatch or steel framed spectacles will affect the compass reading.

Take the precaution of seeing that all iron or steel objects are at a safe distance before using the compass. Small articles will be safe in a trouser pocket but larger articles should be placed two or three metres away.

Note:

Remember to keep away from power lines, wire fences, vehicles and railway lines when using a magnetic compass.

COMPASS RESECTIONS

The following procedure can be used to fix your position when you can recognise features on the ground and on the map but are unable to fix your exact map position.

1. Select 2 or 3 prominent, widely spaced features that you can recognise on the map and on the ground.
2. Using the compass, take a magnetic bearing to the first feature.
3. Convert the magnetic bearing to a grid bearing.
4. Convert the grid bearing to a back bearing and plot this bearing with a thin line from the feature on the map.

Carry out the above procedure until you have plotted the back bearings on the map from each of the features you have selected, your position is that point where the back bearings intersect.

Should they form a small triangle then your position is the centre of the triangle, however, there should be sufficient detail on the ground and the map to confirm this.

Global Positioning Systems

GPS stands for Global Positioning System. It is a military satellite-based navigation system, free for civil use. The system was developed by the US Department of Defence and owned by the Department of Transportation.

The process of Selective Availability [S/A] was turned off in May 2000. Selective availability caused the GPS position to drift randomly & unpredictably giving an inaccurate reading position up to several hundred metres from the true location. Selective availability was at best accurate up to 100 metres for 95% of the time and up to 300 metres the other 5% of the time. GPS accuracy is now to within 10 metres of the true position at all times.

The system uses 24 satellites that circle the earth twice a day in 6 pre set orbits at an altitude of 22,200 kilometres to calculate position, altitude and velocity. This is achieved by GPS receivers on the ground using these satellites as precise reference points to fix their position by measuring the travel time of a signal transmitted from each satellite. The GPS then computes it's distance from the satellite and with this distance and distances from at least 4 satellites can deliver reliable predictions.

Expedition Skills & Campcraft

The rise in popularity of outdoor recreation has led to an increase in the number of bushwalkers and expedition groups visiting national parks and wilderness areas. It is important to remember that as well as recreational bushwalking in small groups there is much interest in the more institutional 'expedition skills training'. This aspect of bushwalking is generally oriented toward youth groups and educational institutions. An expedition is defined as a journey with a purpose.

Groups and organisations are encouraged in the interest of safety to prepare a written plan and leave a copy with a responsible adult in the form of friends, relatives, property owners, rangers or police in the area of the expedition as part of their 'notification'.

THE ROLE OF EXPEDITIONS

Expedition training presents an exciting challenge to groups, it requires them to train for and carry out expeditions or explorations with a specific purpose in unfamiliar country.

Prior planning & preparation

Organising, planning, training for and completing any expedition requires a high level of teamwork, self-reliance and co-operation between group members. Emphasis should be on a preliminary training program designed to develop specific skills related to the particular type of expedition. Ideally the expedition should aim at encouraging group members to gain confidence in meeting new challenges and to develop a spirit of adventure through personal accomplishment.

Expedition purpose

All expeditions should have a clearly defined pre-conceived purpose and all members of the group should have been involved in the planning process and be aware of the purpose of the expedition.

EXPEDITION LEADERSHIP

Organisers of expeditions must be aware of their responsibility under duty-of-care legislation and any appointed leaders should be prepared to accept responsibility for the safety of the group on expedition.

Duty of expedition leaders

The duty owed by an expedition leader to a group can best be described as the duty of a reasonably prudent leader or supervisor who has a duty to take reasonable care to avoid exposing the group to unnecessary risk of injury and while there may be no consideration of remuneration there is nevertheless a relationship whereby the group may be expected to submit to a course of instruction which at times will require them to undertake training and perform tasks in what may prove to be dangerous situations.

The expedition leader is required to provide a safe system for the group and give adequate instruction. There is seen to be an element of dependence upon the leader by the group.

Note:

The expedition organiser is required to guard against a risk of harmful event and injury that is reasonably foreseeable.

Qualifying expeditions

Organisers should be satisfied that the group has completed an appropriate course of instruction for the proposed expedition. Where the requirements for a qualifying expedition state the group must act independently and not be accompanied they should ensure the group are capable of conducting the planned expedition.

Under normal circumstances and if the age of the group requires it the group should be accompanied on the expedition. If they are accompanied on any qualifying venture the leader must ensure that group members make all decisions affecting the outcome of the expedition.

Leaders acting in a supervisory capacity and not accompanying the group must remain in close proximity. The supervisor should be in contact with the group throughout the day and for reasons of safety be available at night.

Note:

The supervisor should have good oversight of the group throughout and accept responsibility for their plans and safety.

PRE-WALK CONSIDERATIONS

To walk with the least impact on the environment the right equipment is needed and all expeditions should be well planned with environmental impact a major consideration.

Expedition members

All group members should have completed a preliminary expedition skills training programme applicable to the level of the expedition.

Notifications

Before you leave let someone know where you will be walking, where you will camp, when you are due back and what equipment the group is carrying. A copy of your plan should be lodged with a responsible adult in the form of friends, relatives, property owners, rangers or police in the area of the expedition.

Note:

Remember that a search will be mounted for you only when you are classified as overdue.

Group size

Go in a small party [6-10] rather than a large one. Large parties usually have more impact on the environment and are socially more unwieldy. Should your group be larger, split up and meet at meal times and at campsites suitable for large groups.

Land owners

As a courtesy ensure that landowners have been contacted before entering their property. If traversing aboriginal land make sure you have the necessary permits, etc.

Environmental impact

In some national parks walking tracks have been upgraded to offset the impact of increasing foot traffic. You can help limit damage by staying on the track and walking through rough and muddy sections rather than widening the damage by walking on track edges. Also avoid cutting corners on steep 'zigzag' tracks.

Both these practices increase erosion and visual scarring as well as causing confusion for future walkers. Sensitive vegetation is easily destroyed by trampling, so stay on rocks and hard ground wherever possible. Choose your footwear for the terrain. Solid lightweight walking boots can be used on most tracks. Wear joggers around the campsite rather than thongs or bare feet.

THE EXPEDITION PLANNING PROCESS

Expeditions require plans to be produced and briefings and de-briefings to be conducted. Briefings are the provision of general information whilst plans contain directives. The de-briefing is used to obtain on-going information and eventual assessment.

BRIEFINGS

The two distinct parts to a briefing are the preparation of the briefing and the conduct of the briefing.

Preparation for a briefing session

Experience has proven that the selection of the best possible venue, and the use of suitable aids will enhance the value of the briefing. Things to be considered include presentation, venue, location, lighting and weather protection. Briefing aids include maps, models, photographs and display boards.

Conduct of a briefing session

Having prepared the venue and aids, the briefing should be conducted in such a manner that the briefing officer controls the activity. The sequence is to conduct an introduction, make sure everyone can see, encourage the taking of notes and set up a format for asking questions.

EXPEDITION PLANS

Expedition plans are the vehicle by which the expedition plan is conveyed to those involved in the expedition. Such orders need to be correctly prepared, presented in a systematic way and re-examined as a result of information gained through de-briefings. They must be accurate, brief but clear, contain all necessary information and most importantly be capable of being actioned.

Layout of expedition plans

Plans need to follow a logical sequence to ensure all aspects are covered. The five headings covered by the plan should include -

- S** Situation
- M** Mission
- E** Execution
- A** Administration & Logistics
- C** Command & Communications

SITUATION [introduction]

Gives background information in sequence and gives general details of the expedition, people involved, topography, others in the area and any resources available.

MISSION [expedition purpose]

A clear, concise, single purpose statement of the overall outcome to be achieved.

EXECUTION [how the expedition will be conducted]

Details how the mission will be accomplished and includes a general outline including details of roles, tasks, method, boundaries and special equipment. This section of the plan should also contain the co-ordinating instructions for the expedition.

Actions On [contingency plans]

Actions to be taken in the event of an emergency or an unexpected happening. These include when the expedition is terminated before the planned finishing time, injuries, lost persons, vehicle break-down, medical emergencies and casualty evacuations.

Co-ordinating Instructions

These are the details common to all members by which the expedition organiser or leader maintains control. Includes details of timings, movement, navigation and transport.

ADMINISTRATION & LOGISTICS [what is needed and what will be provided]

Details of food and water, re-supply arrangements and dress and equipment requirements.

COMMAND & COMMUNICATIONS [leader details and any communications]

Who will be in control and details of communications system including the type of radio, primary and secondary frequencies, call signs, situation reports, radio schedule times, code words and details of telephones and any other methods of communicating.

DE-BRIEFINGS

No expedition should be concluded until a de-briefing has been conducted. This is the primary method employed to assess performance. Depending on the size of the activity and the number of participants there may be different types of de-briefings including phase de-briefings to update information and revise plans and de-briefing of all involved prior to conclusion to determine effectiveness.

De-briefing Methodology

It is a good idea to have a structured approach to de-briefings which requires course participants to analyse the experience by concentrating on performance and outcomes. Activities should be examined to determine what went well and what did not, rather than who went well and who did not. This separation of ego from performance is vital. Activities should be addressed by sequentially examining the following specific aspects –

Facts

This aspect deals with what has occurred and should concentrate on data and facts.

Emotions

Participants should be encouraged to discuss how they feel about the experience and concentrate on intuition, gut feelings, emotions and hunches.

Negatives

Everybody should be given the opportunity to discuss what did not fit and to be judgemental. This aspect deals with negatives, caution, risk and why things went wrong.

Positives

This aspect should always be dealt with after the negatives and should address what went well. It encourages optimistic thinking and deals with positives, benefits and merit.

Creativity

Deals with growth, ideas, alternative uses for what has been learned and future possibilities.

Focus

Finally the group should focus on whether the activity delivered and if all objectives were achieved and the purpose accomplished. Agendas should be set for any future change.

PRACTICAL BUSHWALKING

For members of a group to walk a long way with packs on their backs is as much about mental attitude, self-discipline and teamwork as about physical effort.

Setting off

The first step is to agree on a time of departure and for all to be ready to depart on time with all packs properly packed, being suitably dressed for the weather and taking a last look over the campsite to make sure nothing has been left behind. The first leg of the route should be appraised and maps should be ready.

Walking rhythm

After making a note of the time on your route plan card set off, walking at a slow, steady, deliberate pace. Establish a walking rhythm be aware of it and try to maintain it.

Observations

Keep checking the landmarks and terrain with the map as you reach them. After you have been walking for fifteen or twenty minutes it may be necessary to remove or adjust clothing. It is vital to avoid clothing being soaked in perspiration.

Coping with steep terrain

When the trail becomes steep, shorten your stride but try to maintain the same steady rhythm. If the route should become steeper it will be necessary to zigzag to reduce the steepness of the climb. This enables the heel of the foot to be placed on the ground as it places a great strain on the leg muscles if you only walk on the front of the foot.

Walking down steep terrain may not be exhausting but it can be uncomfortable and more slips and falls occur while descending than while climbing. When you walk on flat ground you automatically lean forward to maintain balance, when walking downhill there is often a tendency to lean back, away from the slope, which can have upsetting results. Make sure that you bend the knees to avoid jarring the joints and zigzag downhill in the same fashion as walking up hill. By doing this, rhythm can be maintained and the whole of the foot can be placed firmly on the ground to improve grip and reduce the chance of slipping.

Note:

Never run downhill and always be careful never to dislodge stones that may injure anyone below.

Wet weather routine

If it should start to rain the whole group should decide to stop together and don wet weather clothing. It is as important to prevent clothing being soaked with rain as it is with perspiration.

Schedules

If the group is falling behind time it may be necessary to reduce some of the breaks or meal stops to catch up with the schedule. This should be discussed within the group to ensure that any changes are not going to place unreal expectations on individuals. It may be that your schedule is beyond the physical capabilities of the group or individuals within the group.

It is a good idea to be realistic when setting schedules and build in an amount of recovery time into a route plan to cope with unforeseen circumstances or slow pace over the ground.

Actions at waypoints

Once you have completed each leg note the time and attend to all needs during the break such as adjusting clothing and packs, checking the route plan, studying the map and visualising the next leg before noting the time and resuming your journey.

Personal fitness

Much of the slow progress and unduly prolonged journey times associated with expeditions lasting a few days are due to a lack of physical fitness. This is especially apparent when faced with carrying a loaded pack.

Any physical exercise or training that will increase stamina will be beneficial before undertaking an extended bushwalking expedition. The personal fitness levels of group members should be accounted for in the planning stage.

JOURNAL WRITING

Journals can help to measure the process and task orientation of an expedition by providing expedition members with a vehicle to focus in a rational way and then reflect on the processes involved in the expedition. They can also be a source of enjoyment and interest for recreational bushwalkers. Interest can be heightened by the inclusion of sketches, maps and photographs.

Journal writing guidelines

The following are general guidelines to what might be written in a journal -

- Feelings on commencing the expedition.
- Understanding of the processes involved and what it is like to be involved.
- Performance as a group member.
- Feelings as a leader when [and if] required to lead.
- Ability and willingness to achieve the set objectives.
- Identifiable behaviour both of self and others.
- Any obvious areas of concern.
- Comments on planning, clothing, equipment and food.
- Any plan for future change not only for physical resources but also behaviours.

SAFETY CONSIDERATIONS

Before any trip the leader and the group should discuss and set their trip objectives. It is important that these should be within the capabilities of the entire group.

Responsibilities of organisers

Organisers should realise the scope of their responsibilities and the duty-of-care questions that may be asked by authorities should any form of accident or disaster overtake an expedition they have organised or sanctioned.

Planning

A brainstorming session with leaders and group members is a good idea in the planning stages of an expedition.

Route plans

All members of the group should have a copy of the route plan and should be aware of any hazardous sections and ensure all maps are current and accurate

Leaders

If there is a leader appointed they should be competent in all skills required for the trip. Assistant leaders must be experienced enough to safely care for the party should something unforeseen happen to the leader. Leaders and assistant leaders should be conversant with the area in which the expedition is conducted.

Medical limitations

Any medical condition suffered by any member of the group or any limiting personal factors or disabilities must be known to the leader prior to commencing the expedition.

Actions-on and safety

In the interests of safety 'actions-on' should be set for all foreseeable emergency situations and all members of the group should know the agreed emergency procedures. An individual emergency procedure card can be printed and issued.

Escape routes and actions should be set prior to departure and must be known to all members of the group.

Notifications

Notifications need to be posted prior to departure and cancelled on return with a responsible adult in the form of friends, relatives, property owners, rangers or police in the area of the expedition.

Police in Western Australia receive training in bushcraft and survival skills and it is a good practice to discuss your plans with them.

Note:

If a walker or group is lost the nearest police should be notified immediately as it is the role of police to organise land search operations in Western Australia.

PRINCIPLES OF MINIMUM IMPACT CAMPING

With the rise in popularity of outdoor recreation has come an increasing risk of damage to the natural environment. Fortunately along with the increasing number of walkers a new bushwalking ethic has also developed. The minimum impact philosophy is now being widely adopted for bushwalking and expeditioning in Western Australia.

Campsites

Look for low impact campsites, sandy or hard surfaces are better than boggy or vegetated areas. Where possible camp at an existing campsite rather than creating a new one. If a campsite does not exist camp at least 50 metres away from watercourses and the track. Spend only one or two nights at such a campsite. With modern camping equipment you should leave a campsite looking as if you have never been there.

Fireplaces

Use only existing and safe fireplaces and remember that compared to campfires fuel stoves are faster, cleaner and a lot easier to use in wet weather. If you need to use a fire use an existing fireplace. Collect only deadwood and keep the fire small and manageable.

Note:

Be aware of fire bans and how they relate to the use of stoves.

Washing-up

Remember that detergents, toothpaste and soap [even biodegradable types] harm fish and water life. Wash 50 metres away from lakes and streams and scatter the wash water so that it will filter through the soil before returning to the stream. Avoid putting food scraps into streams or lakes. Do not wash-up directly under the tap of a rainwater tank. Under no circumstances should you wash in stock troughs on pastoral properties.

Rubbish disposal

Pack to minimise rubbish and avoid carrying potential rubbish such as bottles, cans and excess wrappings. Do not burn, bash or bury rubbish as this disturbs the soil and the rubbish is likely to be dug up and scattered by animals. Carry out all your rubbish.

Note:

If you come across other people's rubbish pick that up too.

Toilets

Where there is a toilet please use it, in areas without toilets bury your faecal waste. Choose a spot at least 100 metres away from camp-sites and watercourses and dig a hole 15cm deep within the soil's organic layer [a hand trowel is useful for this] and bury all faecal waste.

FOOD AND COOKING

The need for a balanced diet becomes increasingly important as the length of an expedition increases. For journeys lasting up to four or five days following normal eating habits will ensure that the diet is adequately balanced. Probably too much thought is given to achieving variety in the menu instead of paying more attention to the need to maintain an adequate intake of liquids, especially in hot weather. Considerably more energy than usual will be expended during a camping expedition, and so more food will need to be eaten to maintain a balance.

Planning menus for bushwalking expeditions

When planning a menu a balance needs to be achieved where you will need to remember that since the food will have to be carried too much will add unnecessary weight to the load. If too little food is taken then the group will go hungry and the efficiency of the group may be impaired. The prime need is to pack as much energy into the smallest possible weight and volume. Increasing the amount of carbohydrates and fats and by using dehydrated, freeze dried and canned food usually achieves this.

Supermarkets carry an endless variety of dehydrated foods and freeze dried meals so if there is a plentiful supply of water there is no need to carry the extra weight of canned food. The packaging of such products is good, they are quick to prepare and usually only require the addition of water. Check how long the food takes to cook and wherever possible choose those that cook in the shortest possible time.

Only carry the foods you like and enjoy and keep all meals uncomplicated and simple to prepare, meals such as soups, stews, casseroles and pasta dishes are ideal. To ensure that you drink sufficiently especially in hot weather always carry more tea, coffee, milk and sugar than you think you will need. Fruit flavoured drink powders and cordials are also useful.

Breakfast

Bushwalking diet is very much a matter of individual preference and the most important consideration is to make it right for you.

Most bushwalkers begin the day with a substantial breakfast and no day would be complete without it. Others prefer to do without washing up greasy pans and prefer cereals or muesli that only requires the addition of hot or cold milk followed by biscuits or bread and jam.

Lunch

Lunches do not usually play an important part in most bushwalkers dietary routine and a little and often is the rule. Cheese and biscuits or biscuits with some spread such as jam or peanut butter are popular as are nuts and dried fruit supplemented with chocolate or sweets. These are a concentrated form of energy and can be eaten on the move. Others prefer sandwiches and fresh fruit.

Dinner

The evening meal is usually the main meal of the day and even when limited to one stove and two or three pans it is possible with a little practice to prepare a hot, filling three course meal in a very short time.

A typical meal might consist of a soup, stew, casserole or pasta dish followed by dessert [hot or cold] or cheese with biscuits and coffee.

A visit to the local supermarket will reveal a great variety of dehydrated meats, textured vegetable protein, soybean, potato, peas and other vegetables, pre-cooked rice, noodles and various pastas and instant soups. There is also a wide selection of whips, mousses and instant desserts that require the addition of cold water or milk and preparations that only require hot milk to turn them into nourishing desserts.

Note:

Plan your menu ahead and experiment with different foods by cooking and eating them at home.

Preparing a meal

When the tent has been pitched and you are ready to prepare your meal, lay out all the ingredients and allocate the pans in which they are to be cooked.

Some prefer to cook a course, eat it while it is hot and then prepare the next course. Others prepare the whole meal and then eat it.

Whichever you choose it is essential to economise on the use of fuel and this can be done by planning the order in which the food is cooked and eaten.

After the preparation of the main course water can be boiled for washing up and for coffee or tea. After the meal the experienced camper will wash up, tidy up, and pack away gear that will not be needed during the night.

WAPA RATION PACK – 8 HOUR FOR 1 PERSON

These ration packs are produced and issued by the Command and Land Operations Unit at the Western Australia Police Academy and are available in two menus and both have been designed to ensure food and vitamin needs are sufficient to meet daily requirements when involved in practical activities in the outdoors.

They have been designed to meet the requirements for a day-walk that does not involve an overnight camp. Each menu contains morning tea, lunch, afternoon tea and trail snacks. With some adjustments to the tea and coffee components both menus are suitable for days of total fire ban.

In keeping with the need for minimum impact on the environment these ration packs are issued in a pre-packed cardboard box and all litter from the pack is to be placed in the plastic bag contained there-in and discarded on return from your trip. No litter is to be burned and/or buried in the field.

An adequate fluid intake is encouraged throughout the day.

MENU 1	MENU 2
1 Can Tuna	1 Can Meat
4 Serves Crispbread	4 Serves Crispbread
1 Single Serve Sweet Biscuits	1 Single Serve Sweet Biscuits
2 Sachets Jam/Honey	2 Sachets Jam/Honey
2 Serves Tea	2 Serves Tea
2 Serves Coffee	2 Serves Coffee
8 Serves Sugar	8 Serves Sugar
1 Can Fruit	1 Can Fruit
1 Energy Bar	1 Energy Bar
1 Serve Cake	1 Serve Cake
1 Packet Sultanas/Sweets/Chocolate	1 Packet Sultanas/Sweets/Chocolate
2 Serves Cheese	2 Serves Cheese
1 Plastic Knife	1 Plastic Knife
1 Plastic Fork	1 Plastic Fork
1 Plastic Spoon	1 Plastic Spoon
2 Sachets Salt	2 Sachets Salt
2 Sachets Pepper	2 Sachets Pepper
1 Serve UHT Milk	1 Serve UHT Milk

WAPA RATION PACK - 24 HOUR FOR 1 PERSON

These ration packs are produced and issued by the Command and Land Operations Unit at the Western Australia Police Academy and are available in two menus and both have been designed to ensure food and vitamin needs are sufficient to meet daily requirements when involved in practical activities in the outdoors.

They have been designed to meet the requirements for a bushwalk that involves an overnight camp. Each menu contains breakfast, morning tea, lunch, afternoon tea, dinner and trail snacks. With some adjustments both menus can be made suitable for days of total fire ban.

In keeping with the need for minimum impact on the environment these ration packs are issued in a pre-packed cardboard box and all litter from the pack is to be placed in the plastic bag contained there-in and discarded on return from your trip. No litter is to be burned and/or buried in the field.

An adequate fluid intake is encouraged throughout the day.

MENU 1	MENU 2
1 Single Serve Packet Breakfast Cereal	1 Single Serve Packet Breakfast Cereal
1 Can Tuna	1 Can Meat
8 Serves Crispbread	8 Serves Crispbread
1 Single Serve Sweet Biscuits	1 Single Serve Sweet Biscuits
2 Sachets Jam/Honey/Vegemite	2 Sachets Jam/Honey/Vegemite
4 Serves Tea	4 Serves Tea
4 Serves Coffee	4 Serves Coffee
20 Serves Sugar	20 Serves Sugar
2 Cans Fruit	2 Cans Fruit
1 Energy Bar	1 Energy Bar
1 Serve Cake	1 Serve Cake
1 Packet Sultanas	1 Packet Sultanas
1 Packet Sweets/Chocolate	1 Packet Sweets/Chocolate
2 Serves Cheese	2 Serves Cheese
1 Freeze-dry or Can Meal	1 Freeze-dry or Can Meal
1 Plastic Knife	1 Plastic Knife
1 Plastic Fork	1 Plastic Fork
1 Plastic Spoon	1 Plastic Spoon
2 Sachets Salt	2 Sachets Salt
2 Sachets Pepper	2 Sachets Pepper
2 Serves UHT Milk	2 Serves UHT Milk

RECREATIONAL 2 – DAY RATION PACK FOR 1 PERSON

This has been designed for bushwalkers for a lightweight 2-day bushwalk and takes into account the fact that a well-cooked meal resembling normal meals can add to the enjoyment of a trip and maintain morale.

It must be remembered that cooking is a skill that must be learned and this food pack encourages experimentation and practice in preparation using everyday items so that preparation methods and times are known before setting out.

As you are carrying this food weight and bulk is important and a good rule is to ensure that food weight does not exceed 1kg per day and provides close to the daily requirement of 15 kilojoules of energy required for bushwalking.

In keeping with the need for minimum impact on the environment food should be packed in a plastic bag and all litter from the pack should be replaced in the plastic bag and discarded on return from your trip. No litter is to be burned and/or buried in the field.

An adequate fluid intake is encouraged throughout the day

Food item	Grams per day	Total weight	How packed
2 Cereal	60	120	Individual packs
Continental bacon	60	120	Wrapped in cloth
2 eggs	60	120	Section of egg carton
4 Biscuits	60	120	Individual packets
Bread	40	40	Plastic bag
4 Margarine or butter	30	60	Pre-packed serves
2 Cheese	60	120	Aluminium foil
4 Honey or jam	30	60	Pre-packed serves
4 Peanut butter	30	60	Pre-packed serves
1 Instant soup	15	15	Foil sachet
1 Freeze-dry meat	70	70	Foil pouch
Fresh vegetables	40	40	Plastic bag
Dried fruit	60	60	Plastic bag
Sweets	30	60	Plastic bag
Chocolate	60	120	Individual bars
Sultanas	60	120	Packet
Milo / Tea / Coffee	30	60	Individual serves
Sugar	90	180	Plastic bag
Salt / Pepper	6	12	Plastic container

CLOTHING AND EQUIPMENT

The careful selection of clothing and equipment is not only important where safety is concerned but is vital to your comfort and enjoyment. This does not mean buying the most expensive, but seeking the advice of those experienced in the outdoors and then making the right choices.

Many authorities have pools of camping equipment that may be borrowed or hired. It is a good idea to do this as it gives you an opportunity to test and gain experience of a variety of equipment before buying your own.

All walkers should have their own clothing, wet weather gear, personal items and emergency equipment. It is desirable that all should eventually have their own pack and sleeping bag.

Use of check lists

Walkers should make a checklist of equipment when they prepare for their first journey. This list should be kept in a notebook and used to check equipment before departure on any future walks. With all the items that need to be carried it is easy to forget one item that may turn out to be vital.

The list should be made under the headings of personal clothing, personal and emergency equipment, personal camping equipment and group camping equipment.

Personal clothing

Clothing must be capable of protecting you under the worst conditions that may be encountered. The rapidly changing conditions and the unpredictability of these changes makes the problem of choosing suitable clothing all the more difficult. The solution lies in carrying extra clothing and then adding or removing layers according to the weather and the amount of physical exertion being undertaken.

Insulation is provided by the air trapped between the fibres of the cloth and between the layers of garments. Therefore two light jumpers weighing 500 grams each provide more insulation than a heavier jumper weighing a kilogram. There is also the added advantage that you can wear one only and regulate your temperature.

Clothing loses most of its insulating qualities when wet. Whether the soaking comes from rain or from perspiration it is essential to keep clothing as dry as possible. This means reducing sweating when working hard by opening or removing clothing and wearing waterproof clothing when it is raining hard.

There are several materials that retain much of their insulating properties when wet, one is wool and another is synthetic fibre-pile. A mixture of wool and synthetic fibre is usually more suited to bushwalking.

Whatever fabrics are used it is customary to have an inner layer of clothing to absorb perspiration, a middle layer to provide insulation and an outer layer to keep the wind and wet weather out.

Garments should be loose fitting either to trap air or allow it to circulate as the need arises. Outer layer garments should be controllable so it is possible to open them up or close air circulation down by fastenings at the cuffs, waist and neck.

Footwear

Boots should be light with flexible, cleated rubber, environmentally friendly soles thick enough to prevent sharp stones being felt and to absorb the pounding associated with bushwalking. The uppers should be made of leather, preferably in one piece with the smooth side out so that they can be polished. A sewn in tongue [bellows type] will prevent water getting in and a combination of D-rings and hooks will make it easier to put them on and take them off.

When you buy boots always take the socks that you are going to use with the boots to wear when you try them on. Even light summer boots need breaking-in so wear them whenever possible and remember that liberal applications of a suitable wax preparation will help the process.

Once boots are broken in regular applications of a suitable leather dressing after use is all that is required to keep them supple and waterproof.

Many bushwalkers wear joggers and while these are adequate they do not offer protection from water and sharp stones or give ankle support. Joggers are often carried as spare footwear and are useful around camp. For safety reasons thongs are not recommended.

Note:

Never borrow boots and always seek advice before buying new ones.

Socks

Socks have to cushion the feet, absorb perspiration and provide insulation. Socks specifically designed for bushwalking are recommended. Frequent washing is necessary.

Underwear

This is largely personal preference although pure cotton is often the better choice. Thermal underwear is popular in cold conditions.

Shirts

Tee-shirts are popular but they do not have a collar to shield the neck from the sun. A 'polo' type shirt with a collar is better. Tank tops and singlets are not suitable for bushwalking as they expose the shoulders to the sun. They also encourage chafing and rubbing from the pack. In colder conditions long sleeved flannelette or wool mixture shirts are effective and are usually good value for money. In hot conditions a cotton shirt with a collar and long sleeves is recommended.

Trousers

Trousers should be loose fitting and suited to bushwalking and for this reason cotton army-type pants are popular. Denim jeans are generally unsuitable as they are usually cut too tight, give little protection in wind and rain, become heavy when wet and take a long time to dry.

Headgear

In the warmer months some form of sun hat is essential. It must have a wide brim and as well as giving protection to the head and face it should also give some protection to the neck. In the cold much body heat is lost through the head and it is essential to protect the head to stay warm. A wool or synthetic 'beanie' or balaclava is recommended.

Gaiters

Specially designed bushwalking gaiters help keep the feet dry in bad weather and when conditions are soggy underfoot. They also save the lower legs from being scratched, keep grass seeds out of socks and boots and give protection from snakebite.

Wet weather clothing

A waterproof jacket provides an outer shell that protects against the elements. Being waterproof, condensation is inevitable and the clothing underneath is bound to become wet through perspiration so these garments should not be worn continually but carried in the pack and only worn when required.

Rain jackets made out of fabrics that 'breathe' can overcome this problem. A jacket with full zip is preferable and a storm flap should protect the zip. The jacket must be large enough to accommodate all the clothing you are likely to wear underneath and long enough to come well down over the hips almost to the knees. A hood, underarm vents, adjustable cuffs and a waist draw-cord will provide maximum control of air circulation.

Waterproof trousers should be able to be put on over boots and it is essential to ensure that they are wide enough in the leg or have zips at the ankles.

Gore-Tex fabric

Essentially a water repellent, protective outer nylon shell glued to a highly breathable membrane of expanded Teflon. With three layer Gore-Tex fabric there is another layer of fine mesh bonded to the inside of the garment that protects the Teflon laminate from the inside and increases the rigidity and durability of the fabric. Because of its expansion process the laminate has more than a billion microscopic pores per square centimetre. Each of them is big enough to let water vapour [perspiration] out but too small to let water droplets [rain] in. The result is an extremely durable fabric that is waterproof, windproof and breathable.

Helly-Tech fabric

A waterproof, breathable fabric that works using a combination of very durable micro-porous and hydrophilic coatings. The coating next to the wearer's body is the hydrophilic layer which serves two functions: it draws water away from the insulating layers closest to the body towards the external environment and also protects the micro-porous layer between it and the outside shell from body oils and other contaminants. The micro-porous layer forms a highly moisture permeable matrix that binds the shell fabric and the hydrophilic coating. The type of face fabric used is also important to the overall performance of Helly-Tech fabric.

Mont Hydronaute fabric

A water repellent nylon face fabric coated with a hydrophilic polyurethane compound that maintains a waterproof, windproof and breathable barrier between the wearer and the elements. The latest generation Hydronaute fabric also has a fine mesh bonded to the inside of the garment to improve durability.

PERSONAL & EMERGENCY EQUIPMENT

Along with the clothing that will be worn or carried in the pack there are a small number of items of emergency equipment that should always be carried by every member of the party. The amount of equipment should be kept to the barest minimum or the exercise becomes self-defeating as the increased weight leads to fatigue.

Essential items

Spare clothing may range from a spare jumper and socks for a day journey to complete changes of clothing for a camping expedition. All group members should carry a small torch, spare bulb, batteries and waterproof matches. A plastic whistle should be carried as well as a pencil and notebook.

Emergency Rations, Personal Survival and First-aid Kits

Chocolate, nuts and dried fruit are a good source of energy and a quantity should be carried as emergency rations. A personal survival kit and personal first aid kit should also be carried.

INDIVIDUAL CAMPING EQUIPMENT**Expedition Packs**

Your pack should be large enough to hold all your equipment and suit your needs. A tough cordura or canvas is suitable and you should try the pack on fully loaded paying particular attention to the waist belt, shoulder straps and harness adjustability. Shoulder straps should be wide and well padded. To take some of the weight off your shoulders a well-padded adjustable hip belt is essential. Modern packs have adjustable back lengths and are ergonomically designed with an internal frame that allows natural body movement.

The pack and our body - a combined system

When we wear a pack, our body and the pack move and work as a combined system. To understand how this system functions it is easiest to first visualise it as four separate 'parts'; the body, the loaded pack bag, the internal frame system and the harness system.

Our Body

Humans come in a wide variety of shapes and sizes. With a typical pack weighing between 15 and 30kg these differences need to be specifically designed for if any measure of pack carrying comfort is to be achieved. Some things to think about first are -

Upright stability. Normally sideways stability is not a problem. By placing our feet far enough apart our weight automatically anchors us between them. This is the low energy stance for riding a bus or train and is automatic. In contrast, if we are pushed or pulled forwards or backwards we must exert muscle force to maintain balance. This big difference between side-to-side and front to back upright stability makes pack shape and load distribution important.

Wearing a pack causes our bodies to incline forward. The human spine carries all of our upper body weight. Its curves, especially the lower or lumbar curve are vital to absorbing the shock of vertical movements like stepping or jumping down. It is essential that our natural posture be preserved as closely as possible when carrying a pack.

Considering all the swinging, twisting, rising and falling of arms, legs, torso and head that goes on when our bodies move, walking is an amazingly effortless process. The reason is that our body parts move in dynamic balance. In our combined pack-body system, packs that are poorly designed, poorly loaded or badly adjusted interfere unnecessarily with our natural dynamic rhythm and demand more energy to carry.

The last thing to note about our bodies is which regions are best able to bear the load of our pack. Only areas well padded by muscle and with some upward facing aspect are able to react to pack weight and comfortably bear the pressure of the pack harness. The upper buttocks extending out to the sides are best suited to bear pressure at the hip level. The back muscles either side of the spine and extending up over the shoulders as well as the muscles on the front of the chest also have sufficient bulk to serve as load platforms. The central lumbar region of our lower spine is poorly padded.

What profile for a given capacity pack bag?

The shape of the pack bag and the way it is packed affects our upright stability and the dynamic balance of our combined system.

Putting on a pack forces us to lean forwards [otherwise we would fall over backwards]! If the pack bag is box-shaped this tilt opens up a wedge between the back surface of the pack bag and the vertical. If the volume in the pack bag is located at the top, we don't need to lean forward so far. This is because the shape puts the pack weight [acting from the pack centre of gravity] closer to directly above our footprint. A more natural posture is possible. As a consequence of this optimal volume distribution for top loading packs the wide bag opening makes packing and access to gear very convenient.

Except for technical activities where turning stability calls for a lower centre of gravity, heavy items like water, fuel or food should be packed against the pack frame just below shoulder height.

For side-to-side stability the bag should be symmetrical and evenly loaded. For dynamic balance the arms need to swing freely, counter-balancing leg movements. Practical issues like moving freely through scrub require clearance, especially at shoulder height. Viewed from the back the bag shape is chest wide at the top broadening out to hip width or more at the base.

Single Compartment Expedition Pack

This type of expedition pack is a rugged, simple expedition pack designed for schools, outdoors clubs, youth organisations, equipment pools and hire agencies. It is generally made from canvas and cordura in 55lt, 60lt and 65lt capacity. They are fitted with an adjustable harness system and weigh approximately 2kg.

The bag features have generally been chosen primarily for minimum maintenance, and lifetime economy. A throat is avoided by cutting the main bag high. They have a simple, laddered and lined lid and highly effective back pocket that completely eliminates zips. The natural wet weather performance of these canvas packs is good insurance against novice users having to suffer the consequences of wet gear.

Twin Compartment Expedition Pack

A twin compartment pack whose capacity and comfort simplifies the load carrying problems of ambitious bushwalkers when factors like the need to carry fresh water, additional food, cold weather clothing or specialised equipment arise. These are usually made from canvas and cordura in 80lt, 90lt and 95lt capacity. The zippered access into the lower part of the pack is useful when early starts and long days limit the opportunities to dry damp sleeping bags and other gear normally stowed low in the pack. A simple, yet strong shelf separates the two compartments.

Sleeping Bags

It is impossible for one sleeping bag to cope with all extremes and most bushwalkers settle for an all-season bag. Outer material is usually downproof rip-stop nylon with the inner made from nylon. In between there is a synthetic fibre filling that provides very high thermal insulation for its weight. This fibre has an exceptional rebound factor allowing it to be compacted into a small space and is warmer than down filling when wet.

An inner cotton or polyester bag must be used with hired or borrowed sleeping bags and they should be used in down bags to keep the bag clean. An inner bag also gives you more versatility in very hot weather as you can sleep in it on top of your sleeping bag.

Sleeping Mats

A closed cell foam sleeping mat or self-inflating mattress is essential and as the foam does not absorb water they can be carried on the outside of the pack.

Water

Each member of the party should carry their own water and between one and four litres will be needed per day depending on local conditions.

In-camp gear

Each individual needs a plastic mug, a steel or plastic plate and cutlery. Toilet gear should include soap and towel, toothbrush and toilet paper. All members must take responsibility for their own garbage and carry sufficient garbage bags for the trip.

GROUP CAMPING EQUIPMENT

Tents

A tent is the typical symbol of camping, but it is much more than that. In the most extreme environments the correct selection of shelter is often the most important decision you can make. Of course, even if it's not life or death and for most of us happily it is not, the right choice does make all the difference if you want to have an enjoyable time in the field.

There are dozens of lightweight tents available for the bushwalker to choose from and they come in all shapes and sizes. Many authorities have tents that they lend or hire out. Before you buy a tent borrow one of the same kind so you can examine the quality of construction and try it out for size and convenience.

The tents used on expeditions usually hold two or three persons with the load being shared between the occupants. It is usual to have a breathable nylon or cotton inner with a waterproof nylon fly and a slightly heavier, waterproof nylon floor. If a borrowed tent is to be used, pitch it before the start of your venture to ensure it is complete and that you know how to erect it.

The Dome Tent

These are compact, easy to carry and usually have two diagonal tent poles with a vestibule. They are easy and fast to assemble and are best fitted with pole clips. Usually constructed with a waterproof polyester fly and waterproof nylon floor all seams should be tape seam sealed for immediate use. They are suitable for most camping and bushwalking expeditions.

The Tunnel Tent

This type of tent is recommended as a compact 2-person, ultra-lightweight, double-skinned, expedition tent with good ventilation suitable for warm weather conditions as well as for travel in snow, across exposed country and in severe weather. The design is a classic two arch tapered tunnel with careful attention paid to equalising skin stress over the outer tent surface and to avoiding unnecessarily large areas of unsupported fabric. Access into the tent is usually provided at each side of the main arch. Both ends of the outer and inner can be fully unzipped for ventilation. Gear stowed under the vestibule should not hinder access to the tent.

Overhangs

Overhangs are a simple, lightweight shelter suitable for most conditions in Western Australia and are the shelter of choice for CLOU trainers and students on field operations where a tent is inappropriate. They are simply a lightweight tarpaulin, made from UV resistant, waterproof ripstop polyester and are considered to be the lightest and most compact two-person shelter available. They should be catenary cut, reinforced where needed, be factory seam-sealed and all edge guy points should be fitted with guy cords and adjusters that stow in pockets at their attachment position so massive tangles can be avoided when the overhang is unpacked ready to pitch. When tension to the guy lines is applied they should pitch taut without excessive stress anywhere.

When used as an individual primary shelter in hot dry conditions overhangs work effectively pitched up high to provide shade and catch any breezes. They should be pitched low if it's wet and windy with one end filled in with your pack to provide a buffer against wind.

Alternative uses for overhangs include -

- They make an ideal cooking or field meeting shelter and work effectively pitched up high.
- They can be used on the side of a vehicle as an awning.
- One point can be weighed down to collect water.
- They can be used as a ground sheet whenever the need arises.

Cooking Stoves

Cooking should be approached as an enjoyable part of expeditions and stoves need to be light and compact to carry in a pack and not too expensive. They should be simple to assemble, operate and clean. They should also require no special maintenance and be easy to light. Even in the harshest of weather conditions you need to be able to easily light the stove and successfully cook food or heat water in a short period of time.

Methylated Spirit Stove

These stoves are very popular and serve a dual function of stove and cooking set. They are easy to light and there are no complicated ignition devices. By turning the ventilation holes into the wind you optimise the oxygen supply to the burner, which increases the efficiency of the unit. These stoves are very stable with pots set deeply in the upper windshield. Handles, pots, kettles and a frypan, which doubles as a lid are included in the unit.

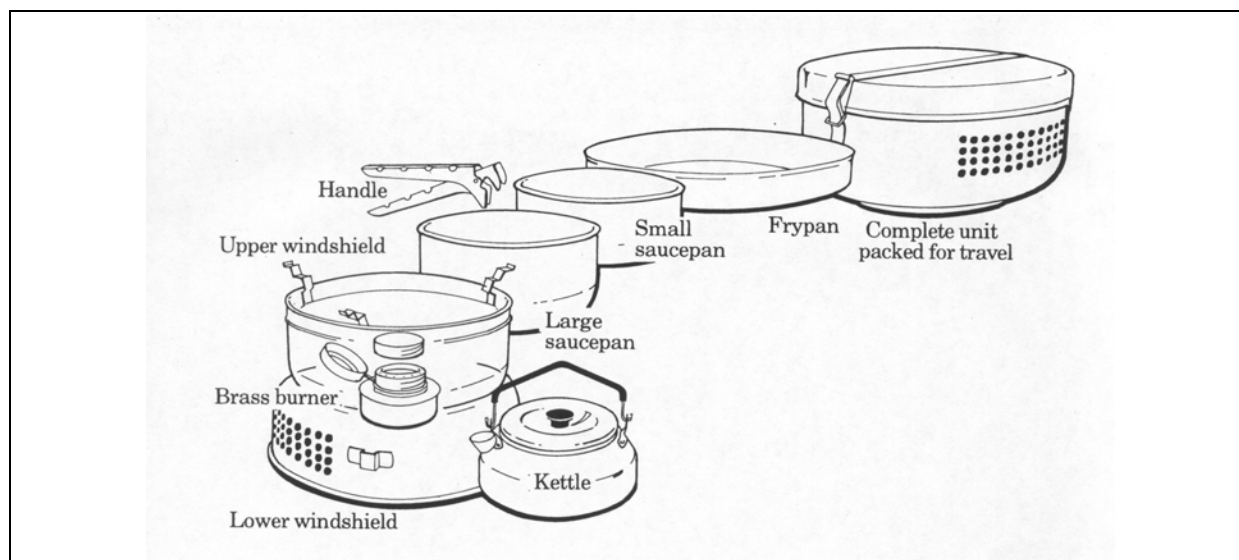

The Trangia No.25-8 Camping Stove

Note:

Methylated spirit burns with an invisible flame in sunlight and care must be taken to ensure the flame is completely extinguished and the burner cooled before refuelling.

Multi Fuel Stove

The multi fuel stove is ideally suited to extremes of weather and they usually have an extra flame control valve that allows immediate control over a very broad range of temperatures. They are fully field maintainable, extremely compact, burn shellite, unleaded petrol, aviation fuel, diesel, and kerosene along with a few others. The best are fitted with a 'shaker' jet for self-cleaning. Correct use and maintenance is required for safety reasons.

Carrying liquid fuel

Liquid fuel should only be carried in an Australian Standard approved bottle with a secure screw top.

Portable Gas Stove

These are extremely simple to operate and are favoured for day walks and situations where cooking needs are minimal. Features on the best of them include an automated match-less lighting system and specially designed burner grates. They generally boil water in 3-5 minutes and usually burn for one hour on high or two hours on low using a standard gas cartridge.

EXPEDITION EQUIPMENT CHECK LIST**Clothing**

Boots, joggers, socks, underwear, trousers, shirts, jumpers, jacket, headgear, gloves, waterproof jacket and waterproof over-pants.

Emergency equipment

Maps and map case, watch, compass, whistle, emergency rations, matches, torch with spare globe and batteries, knife, survival kit, first aid kit, note book and pencil

Personal equipment

Backpack, sleeping bag, sleeping mat, inner bag, toilet gear, toilet paper, water bottle, cup, plate, knife, fork and spoon.

Group equipment

Tent, stove with fuel, group water container, dish washing, soap pads or nylon scouring pad, trowel, cloth or tea towel and garbage bags.

PACKING AND LOAD CARRYING

Packs are rarely waterproof and experienced walkers solve this problem by using a heavy gauge plastic bag inside the pack as a waterproof liner. In addition every item of clothing carried in the pack along with the sleeping bag and the food should be protected individually by placing them inside plastic bags and sealing them.

Pack weight

Pack weights should not exceed a quarter [25%] of your body weight and the nearer this load is to your centre of gravity the less strain and fatigue it will impose on your body. Modern packs are designed to do this and you can assist by placing heavy items high up in your pack and as near to the body as possible.

Considerable experience is needed to keep pack weight to a minimum and to avoid anything but the essentials being carried. Inexperienced walkers are often inconsistent in their attitude to weight. Packs must always be weighed before departure and it is a good idea to keep placing them on bathroom scales while you are gathering your equipment. In this way if items have to be eliminated it will not have to be done in a hurry before setting out.

Packing is largely common sense but it is necessary to balance conflicting needs. Since the 'last in - first out' rule applies, items that will be needed en-route should be placed in the side pockets or at the top of the pack. Wet weather gear, spare clothes such as jumper, gloves or headgear and food that is to be eaten during the journey should be ready to hand. The sleeping bag and clothing that will not be needed during the walk and which are bulky but lightweight should go to the bottom of the pack. Heavy items or shared group equipment such as the tent and stove should be divided equally between the occupants of the tent and can go into the pack next with the rest of the gear on top.

Many problems arise from packing at the last moment and then throwing in whatever comes to hand. Forethought is required and your kit should be assembled well in advance for the expedition. Planning to do the job well always takes longer.

Note:

All gear other than sleeping mats should be carried inside the pack.

CAMPCRAFT

Camping improves with practice and the ability to provide food and shelter under all conditions is a skill worth acquiring. It will give you confidence, satisfaction and enjoyment as well as allowing you to participate in other outdoor activities.

Choosing a campsite

Choosing the right campsite is not only important for your comfort and enjoyment but can affect your wellbeing. Finding shelter from the wind and prevailing weather should always be uppermost in your mind when using a lightweight tent. This usually means seeking lower ground using hollows or the leeward side of a ridge, hill or trees as a windbreak between your tent and where the wind or weather is coming from. Other factors to be considered when choosing a campsite include making sure it is free from hazards such as flooding, falling rocks or tree branches. Where possible make sure it is reasonably near to water and offers the prospect of a reasonable night's comfortable sleep.

Note:

Remember; 1600 hours [4 pm] is a good time to make camp, 1700 hours [5 pm] is running it a bit tight and 1800 hours [6pm] is leaving it too late.

Pitching tents

The ground under the tent needs to be as clear and level as possible. If there is a slope then it is best to sleep with your feet down hill. The ground needs to be reasonably dry and soft enough to sleep on and to take tent pegs. Remove any object that might puncture the tent floor. Pegs need to be driven into the ground at an angle of 45°. Guy lines and pegs should be run out in line with the seams and heavier or larger pegs used for the main guys. If the ground is too soft then stones will need to be placed on top of the pegs. The tent should be pitched so the entrance faces away from the wind.

Note:

Tents should never be pitched under trees.

Living in a tent

When two or three people are living in a small tent personal organisation and tidiness is essential. Campers should be prepared for the worst with equipment no longer needed being restored to the pack. Everything should be in its place and torches handy before turning in. Sleep with your head to the door of the tent to allow easy exit in an emergency.

Establishing a routine

A routine should be established between the inhabitants of a tent and the question of who does what should be sorted out on reaching the campsite. No matter how footsore and weary the group may be it is good practice to pitch the tent when reaching an overnight campsite.

Daily Routine

Morning	Afternoon
<ol style="list-style-type: none"> 1. Wake party. 2. Light fires/set up stoves. 3. Take down and pack tents and shelters. 4. Attend to personal hygiene. 5. Breakfast. 6. Fill and check water containers/bottles. 7. Attend to first-aid and inspect feet. 8. Check and pack gear. 9. Conduct a group briefing and set off. 	<ol style="list-style-type: none"> 1. Lunch. 2. Check and pack gear. 3. Conduct a group briefing and set off. 4. Set up overnight campsite. 5. Attend to first-aid and inspect feet. 6. Dinner. 7. Attend to personal hygiene. 8. Conduct a group de-briefing. 9. Write up track logs and/or journals.

Cooking

In dry weather cooking can take place in a sheltered place away from the tent making access to the tent easier. In wet weather cooking should be done outside the tent under the shelter of the flysheet or vestibule. There should never be any need to cook inside the tent. While one person, having removed boots and water-proof clothing cooks in the shelter of the doorway the others in the group can ensure that everything needed for the meal and the washing up afterwards is within easy reach of the person doing the cooking.

Note:

Boots or outside footwear and wet clothing should not be worn inside the tent. The lightweight floor of the tent must be treated with great care.

HYGIENE

Hygiene is an important aspect of expeditions and camp discipline and personal cleanliness needs to remain at a high level. Face, hands and feet should be washed and teeth cleaned at the end of each day. Socks need to be washed frequently and can be dried if the weather is fine by attaching them to the outside of the pack while walking.

Water supplies must be kept clean and dirty washing up water should be poured into a hole made with a trowel in soft ground well away from the water source. Dirty or greasy water must never be thrown back into creeks or waterholes and personal washing should be done away from the source of drinking water.

Do not wash-up or use soap in stock troughs. All litter must be removed from the campsite and carried out by the group. It is no longer acceptable to bash, burn and bury rubbish. Be prepared to remove your rubbish by carrying a few plastic garbage bags with you.

WEATHER CONSIDERATIONS

No matter how much information there may be on a weather map it must always be read with an eye to local geographic conditions. With a little experience it is possible to predict when it will be wise to stay and when it will be possible to venture out.

Sky Signs

For all the scientific tricks there may be up our modern sleeves, we still rely for local forecasting on some of the weather lore of our forefathers. It is still true to say that a red or clear sky at sunset usually predicts a fine day to follow, while a grey or dark cloudy evening or a diffuse watery sky suggests a wet or windy tomorrow.

When clouds break up at sunrise, or the sun comes up through haze into a clear sky, it usually heralds a fine day, but the early red sky or a colourless sun, especially if there is a rainbow or halo around it, warns of rain and unsettled conditions. The larger the halo, the sooner the rain will arrive. The behaviour of the barometer should not be neglected when making such judgements.

Behaviour Of The Barometer

Rapid falls in pressure always precede rain and storms, and maybe a change in wind direction, squalls or the imminent arrival of a cold front. If at the same time the temperature is above normal and the humidity high or rising, unsettled weather and rain are usually on the way. Once the change is past, cooler and clearer weather will follow.

When the barometer steadies and begins to rise, clearing weather comes quite rapidly. Remember however that any really rapid rise in barometric pressure after bad weather can bring wind and unstable conditions instead of the expected fine weather.

When the barometer begins to fall slowly after a spell during which it was steady, the area is likely to be visited by unsettled and wet weather, and a halo round the sun or moon will usually confirm that forecast. No matter how long it stays fine as the barometer goes lower, it is certain wind and rain will eventually come. Usually a high barometric reading brings settled conditions.

WEATHER PATTERNS IN WESTERN AUSTRALIA

It is possible by examining weather patterns over a period of time to predict the kind of weather that may be experienced at any particular time of the year. But even when it is based on an average of the statistics remember that such forecasting is never infallible.

January – February - March

Western Australia is so extensive it samples all possible climates except perhaps alpine. In January, low-pressure troughs bring hot continental winds. February brings great contrasts in rainfall, with occasional tropical cyclones and heavy rain. Apart from these, the month is quite dry, but the humidity can be high. The rainfall is heavier in March, but mainly in the north where there is a risk of rivers flooding.

April - May

The high-pressure belt begins to drift northward in April, and westerly winds become more general in the southwest. The rainfall also increases. The increase continues through May, when the westerlies become more general, with a few fogs developing.

June

The high pressure belt continues to drift northward through June and it brings the low pressure systems closer to the coast in the south, increasing the rainfall still more until it is the heaviest of any month in the year, especially near the south coast.

July - August

July is the coldest month of the year in the state. There are occasional gales and flooding in the southwest, but elsewhere there is generally a noticeable decrease in rainfall. The high-pressure systems begin to move southward in August, but the weather remains similar to that of July. In the north it is the driest month of the year, but it is still fairly wet in the southwest, with occasional flooding.

September – October - November

In September, the low-pressure systems are more southerly, and the winds move westerly in both the north and south, but easterly in central coastal areas. There are likely to be some gales in the southwest, but little rain. The belt of high pressure systems moves farther south in October, and by November is in southern waters, but occasionally it moves north enough to bring westerly winds and showers.

December

There can be cyclones during this month and these are even more likely in the north-west when there are low-pressure systems in the Bight, and easterly winds farther north. The tropical areas have more westerly winds and much more cloud at this time, but it remains hot.

Summary

On the whole, Western Australian weather is under the influence of a belt of high-pressure systems that crosses the north of the State in winter and brings fine weather so long as it remains. This belt drifts southwards for summer and takes it's fine weather with it. Cyclones form from the low-pressure systems that move in to fill the area left.

