

By the Same Author

THE JUNIOR BOOK OF CAMPING AND WOODCRAFT

WOODCRAFT

JUD GOES CAMPING

DANCES AND STORIES OF THE AMERICAN INDIAN

DRUMS, TOMTOMS AND RATTLES

ROPING

PRIMITIVE AND PIONEER SPORTS

CAMPING AND EDUCATION

THE BOOK FOR JUNIOR WOODSMEN

As co-author with E. D. Mitchell

SOCIAL GAMES FOR RECREATION

ACTIVE GAMES AND CONTESTS

THE THEORY OF PLAY

# WOODSMANSHIP

by **BERNARD S. MASON**

drawings by **Frederic H. Kock**

A. S. Barnes and Company      New York

Copyright, 1945 and 1954, by A. S. Barnes and Company, Inc.

All rights reserved. No part of this book may be reproduced in any form, either wholly or in part, for any use whatsoever, including radio and television presentation, without the written permission of the copyright owner with the exception of a review quoting brief passages in a magazine or newspaper. Manufactured in the United States of America.

Published on the same day in the Dominion of Canada  
by The Copp Clark Company, Ltd., Toronto.

Library of Congress Catalog Card Number: 54-5406

Most of the material in this book previously appeared in  
THE BOOK FOR JUNIOR WOODSMEN (A. S. Barnes, 1945.)

## CONTENTS

Men of the Woods	1	Cording	40
Dressed for Yonder Country	2	The Handy Pulphook	41
Sure Footing	3	Carrying Logs	43
Pole-ax	4	Come-alongs	44
Cut to Your Size	5	Skidding	46
Double-bit	6	Pike-poles	47
Cruiser Ax	7	Birling	48
Axes, Axes, Axes	8	Splitting Logs	50
Handle with Care	10	Wedges and Gluts	51
The Hang of It	11	To Drive Wedges	52
Whose Fault?	12	As Thin as a Rail	53
Muzzled Axes Don't Bite	13	Horse-high, Bull-strong and Pig-tight	54
Giving it Teeth	14	Beetles	55
For Speed and Safety	15	Chopping Blocks	56
The Old Grinding Wheel	16	Splitting Stovewood	57
Chopping	18	Getting the Shakes	58
High, Low, and in the Middle	19	Hew to the Line	60
How Big is the Cow's Mouth?	20	With the Aid of an Adz	61
Misery Whips	22	Shaving Horse	62
Don't Drag Your Feet	24	Crooked Knife	64
Old-Fashioned Bucksaw	25	Stump Vise	65
Modern Bow-Saw	26	Barking	66
Its Teeth Need Brushing	27	Brushing	68
Felling with an Ax	28	Getting Down to Roots	70
Which Direction?	29	Taking the Stump	72
Felling with a Saw	30	More Power to You	73
If the Tree Leans	31	Wilderness Auto Tracks	74
Freeing a Lodged Tree	32	Catamaran	75
Pushing Them Down	33	Your Ax is Your Knife	76
"T-I-M-B-E-R" - Beware	34	Slab Pigs	77
Watch Out for Kickbacks	35	Backwoods Plumbing	78
Lopping the Branches	36	Water Boy	79
Bucking Up	37	Giving 'er Snoose in the Roleo	80
The Bucker's Horses	38	Nailing Down the Size	82
Peavey and Cant-hook	39	Logging Lingo	84



*WOODSMANSHIP*

## SURE FOOTING

NOTHING ROBBS A MAN OF HIS COURAGE in crashing the brush and slash-piles so much as flimsy shoes. When well-shod and rough, he wades right into the mess, but with poor foot protection, he minces his way, picking every step, and worrying lest he bark his ankle or crack his shin. The wise look well to their boots.

Nine inches is the proper height for a boot, not over ten. Lower than that they offer no shin protection, and shins are sensitive; and, moreover, the pants leg cannot be tucked in, and tucked in they should be lest the flappy bottoms catch on every stub to trip and rip. Those who prefer their pants legs open should cut them off at the top of the boots, stag-pants style. If low shoes must be worn, wrap the pants leg around the ankle and tie them. Knee-high boots are seldom worn in the bush—they are hot, heavy, and wholly unnecessary.

The *moccasin pac* is the lightest, most flexible and most comfortable boot made, yet sturdy withal, offering good protection. It has one shortcoming—it is slippery on wet rocks and grassy slopes. In that kind of country, a moccasin pac with a rubber sole is better. Some prefer it anyway because it has a heel.

In swampy going, ordinary rubber pacs are excellent. They are usually worn with an arched innersole inserted. Avoid waterproof leather boots—they are never watertight, and are unbelievably hot.

In working on logs, leather boots with heavy calked soles are necessary to prevent slipping.

Whatever the boot, wear heavy wool socks, preferably two pairs, to give the needed padding. Heavy socks cushion the feet and absorb the shock.

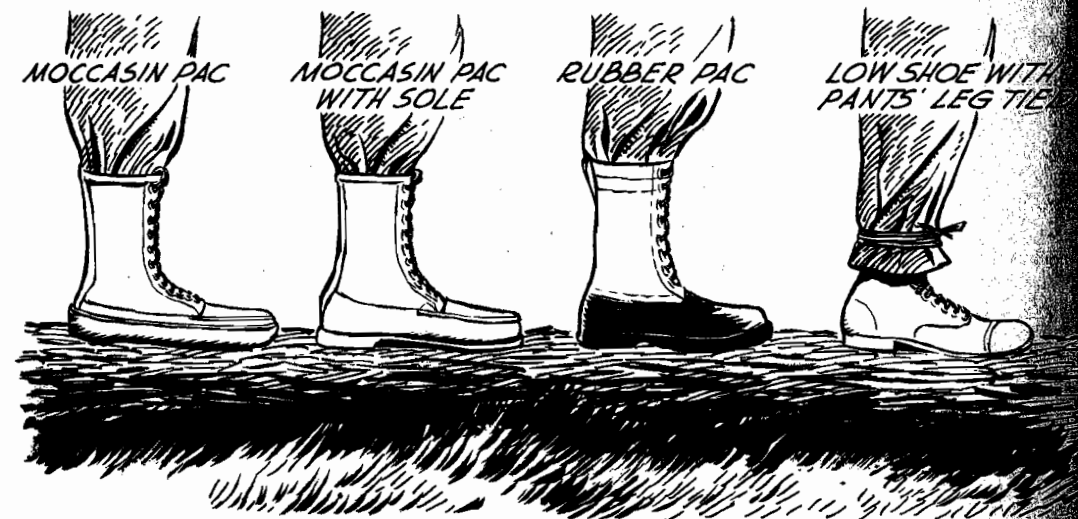

## POLE-AX



EVERYONE KNOWS THE POLE-AX, even though he may not know it by that name. It is an ax with a hammer surface opposite the cutting edge, as shown in the drawing. It is the commonest type of ax, the type that comes to one's mind when the word "ax" is mentioned. The hammer surface is called a *pole*, hence the name *pole-ax*.

While any ax with a hammer surface may rightly be called a pole-ax, including even the little Scout ax, yet the term as it is commonly used refers to a large ax of this type. One speaks of his pole-ax to differentiate it from his double-bitted ax of equal size.

It is a good habit always to speak of one's pole-ax by that name, not merely to call it an ax. In doing so, one is using the terminology of the woods and the logging camps. Similarly, it is important to know the names of the different parts of an ax, and to refer to them by the proper terms. One's talk, as well as his skills, labels him as woodsman or tender-foot.

Of the two main types of axes—*pole-axes* and *double-bitted axes*—the pole-ax is to be preferred for general use. It is the all-purpose ax, meeting the situation whether it be splitting, chopping, or the hammering an ax is called upon to do. It reigns supreme on the woodpile, for it alone is suitable for splitting wood. And it should never be sold short as a chopping tool. If only one ax can be had with which to do all kinds of work, that ax should be a pole-ax.

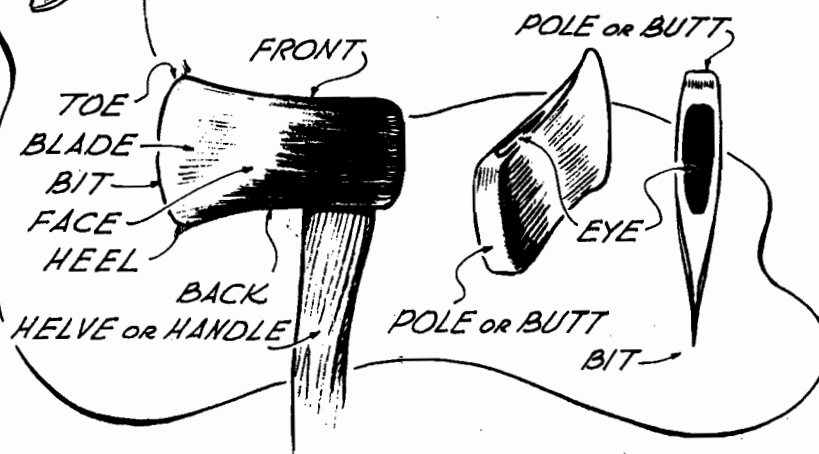

## CUT TO YOUR SIZE

TOO BIG AN AX is a hindrance. It causes strain and destroys your aim. One gets out more work with an ax that fits—one that fits him and fits the job he is doing. No burly lumberjack would use a larger ax than the job requires. A full-sized pole-ax is not needed for chopping as often as one might think. The smaller *pulpwood ax* is usually large enough.

Large pole-axes range in weight from three to five pounds. Most woodsmen prefer a 3½-pound one with a 36-inch handle, which is heavy enough for any use. But such big axes are needed only for splitting firewood and for chopping big timber. For most other tasks the pulpwood size is adequate.

The *pulpwood ax* weighs 2½ pounds and has a 28-inch handle. It is the ax used in pulpwood logging, where the trees seldom run over a foot in diameter at the butt. For such work no logger would ask for a heavier one. It is unexcelled as an ax for boys; indeed, this size is often cataloged by manufacturers under the title of *boy's ax*.

The *cedar ax* is another superb ax of the same size. Its wide bit, shown in the drawing, was developed for use in the cedar country of Texas where a tangle of branches and brush must be cleared away before getting to the tree. But it is becoming popular the country over as an all-round chopping ax for light timber.

These 2½-pound axes with 28-inch helves are referred to as *three-quarter axes*. If one of these is handy, you will find that you will seldom pick up the big pole-ax. They are type-perfect for boys and women, and large enough for the chopping most men will do.

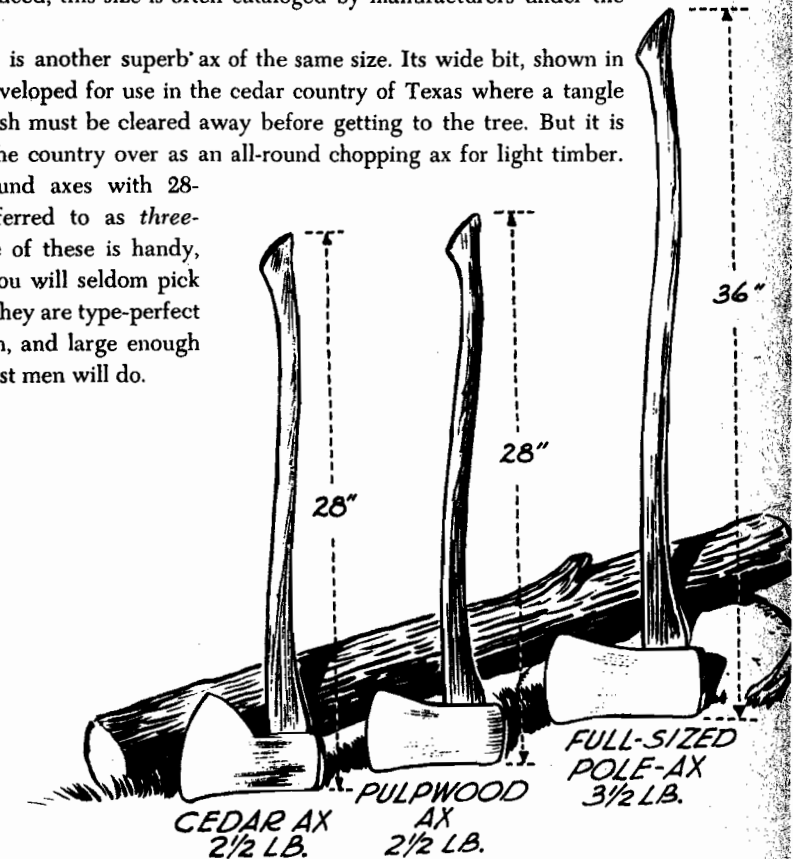

## DOUBLE-BIT



THIS MIGHTY AX of the Northland is the token of true woodsmanship. A *double-bitted ax-man!*—thus is the man spoken of who is master of the skills of the timber country. Not that this ax is so much more difficult to use, but that it is the tool of the professional logger, and as such has become the symbol of expertness.

The double-bitted ax developed in the North country where the trees were big and logging was an industry, and it accompanied the lumberjacks from Maine across to Oregon. One sees double-bits on every hand in these Northland lumber camps, but may search long to find a single pole-ax.

The characteristic of the double-bitted ax is that it has no hammer surface as does the pole-ax, but rather has two cutting edges opposite each other and both in line with the handle.

This chosen ax of the lumberjack has many advantages, and on the other hand, as a tool for the inexperienced it has many disadvantages. Those who are accustomed to it claim that there is a balance and trimness about it that makes the pole-ax seem clumsy by comparison. Its weight is all in line with its cutting edge—it seems to swing more true to its mark, and to bite deeper. More important still, its two blades make it a *dual-purpose* chopping ax—two axes in one. The woodsman grinds the two blades to different thicknesses, each for a different purpose. The thin bit he reserves for clean, fast chopping, and the thicker one he uses around knots, in cutting roots, and in working near the ground where a slip means a nick. Thus he is able to protect his keen bit and keep it razor-sharp.

But be it known that the *full-sized double-bit* is a specialized tool that belongs only in the hands of the professional logger. It is big—and vicious. It is too much ax for the average person. It is dangerous in other than expert hands, and it is not needed outside the logging industry. The lighter and smaller *Cruiser Ax* is the double bit best-suited for average needs.

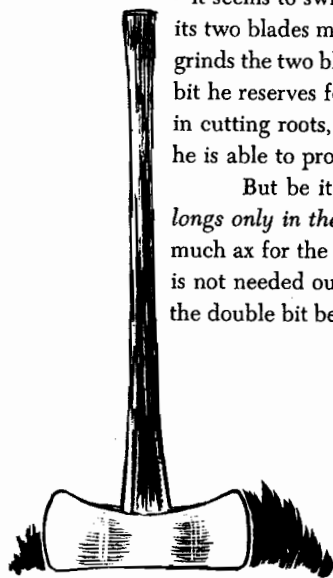

## CRUISER AX

THE CRUISER AX is a double-bit cut down to a size convenient to handle. It weighs  $2\frac{1}{2}$  pounds and has a 28-inch handle. It is thus a three-quarter ax—the double-bitted companion of the pulpwood ax—yet it is capable of tackling with ease any kind of timber up to a foot in diameter. It has all the advantages of the double-bit, yet none of the unwieldiness of its overgrown brother of the logging camps. And it is much safer. Rarely is a larger ax needed outside of the logging industry, and if it is, a pole-ax would be preferable.

The Cruiser is a good ax to know. It is a standard pattern and is made, with slight variations, by all ax manufacturers.

The best feature of the Cruiser is that it can be muzzled, a very important consideration, for double-bits are notoriously dangerous to carry. Sheaths are sold for it, and *in the sheath it should always be when not in use*. When muzzled, both the ax and the people around it are safe. In spite of its long handle it can be carried on the belt, but whether by belt or hand, it should be in its sheath.

The Cruiser was originally developed for use by the timber cruisers of the Pacific Coast who needed a first-class, efficient ax, yet one light enough to be carried while cruising afoot. But filling a widespread need as it did, its popularity spread rapidly to other areas and for other purposes. Today it stands as one of the most useful axes made.

A *measuring stick* is good to have along in the woods, and the handiest place for it is on the ax handle. If the ruler marks are *burned* on with a hot wire they become permanently fixed and clearly visible, yet do not rough up the handle. Never notch them on, for an ax handle must be absolutely smooth and slick. A two-foot ruler can be marked on the Cruiser handle.

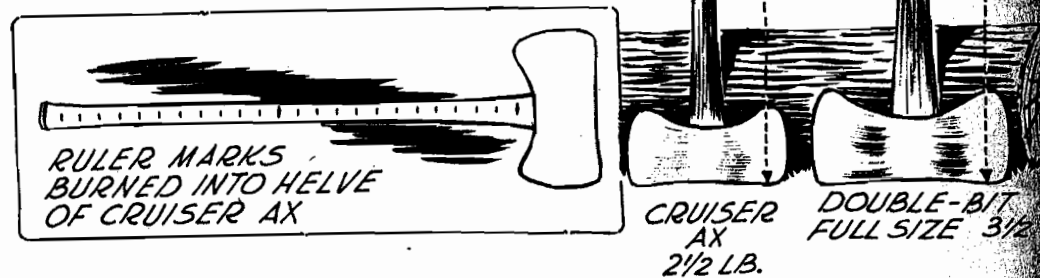
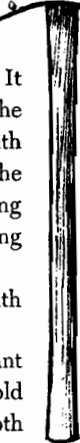
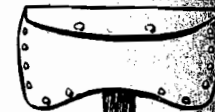

## AXES, AXES, AXES

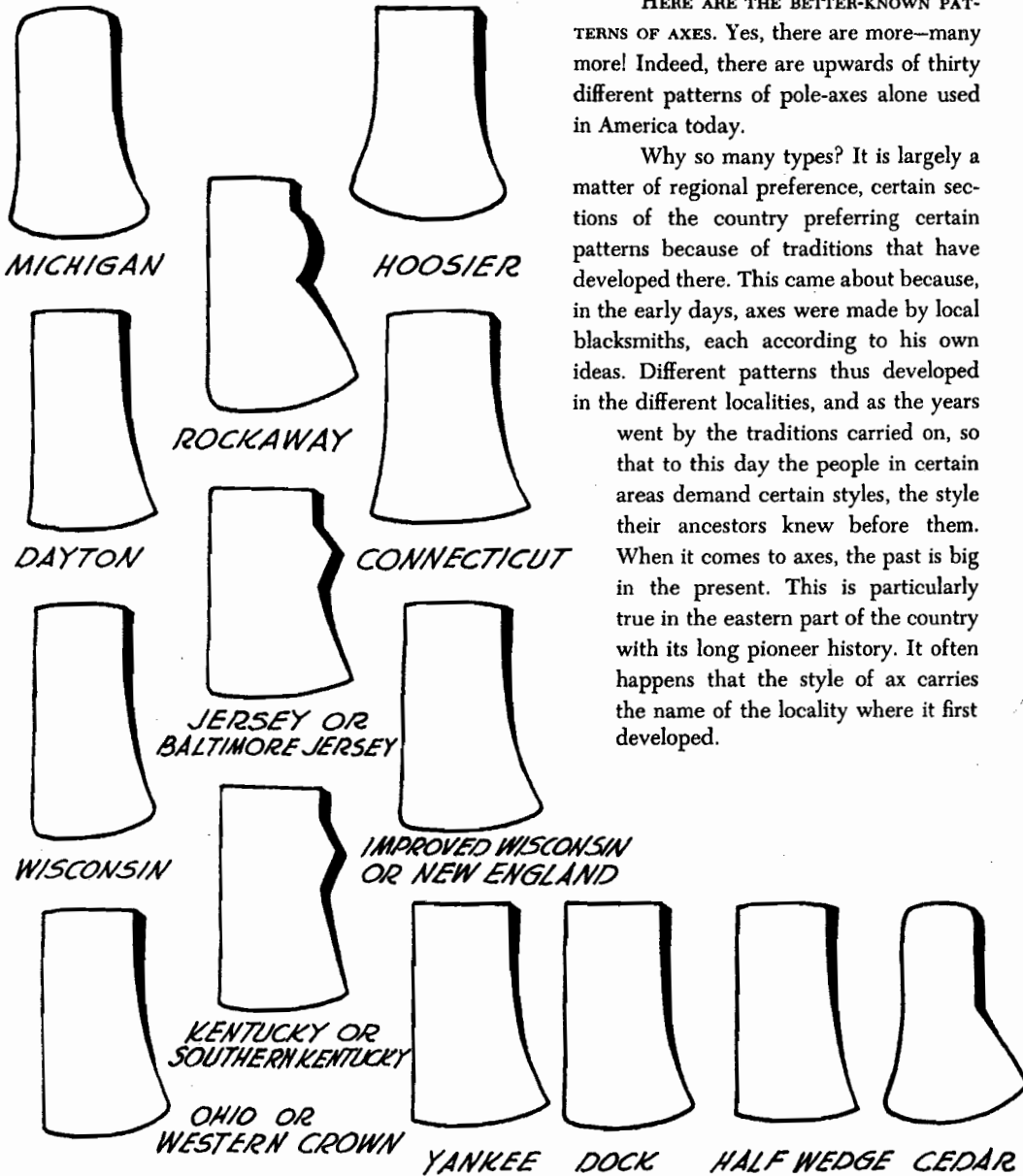

HERE ARE THE BETTER-KNOWN PATTERNS OF AXES. Yes, there are more—many more! Indeed, there are upwards of thirty different patterns of pole-axes alone used in America today.

Why so many types? It is largely a matter of regional preference, certain sections of the country preferring certain patterns because of traditions that have developed there. This came about because, in the early days, axes were made by local blacksmiths, each according to his own ideas. Different patterns thus developed in the different localities, and as the years went by the traditions carried on, so that to this day the people in certain areas demand certain styles, the style their ancestors knew before them. When it comes to axes, the past is big in the present. This is particularly true in the eastern part of the country with its long pioneer history. It often happens that the style of ax carries the name of the locality where it first developed.

Thus it happens that when one goes into a local store to purchase an ax, he usually finds, not many, but one style of ax on display—the traditional style for that particular area. And thus it happens that if one orders an ax direct from the manufacturer without specifying the style, the manufacturer will usually determine the style by the section of the country from which the order came.

How, then, can we select an ax from this maze of patterns? In pole-axes, the *Michigan* pattern is the most widely used, and the next in popularity is the *Dayton* pattern. Unless one wishes to follow the tradition of the particular locality in which he lives, he will do well to select one of these, preferably the *Michigan*, which is probably the pattern best-adapted for general use. Among double-bits, the *Michigan* is again the most widely used, with the *Western* second in popularity.

The axes designed for special purposes, such as the Peeling, Half-Peeling, Falling and Swamping types, for example, are tools for the logging industry, where each has particular duties to do. They are not adapted for general use.

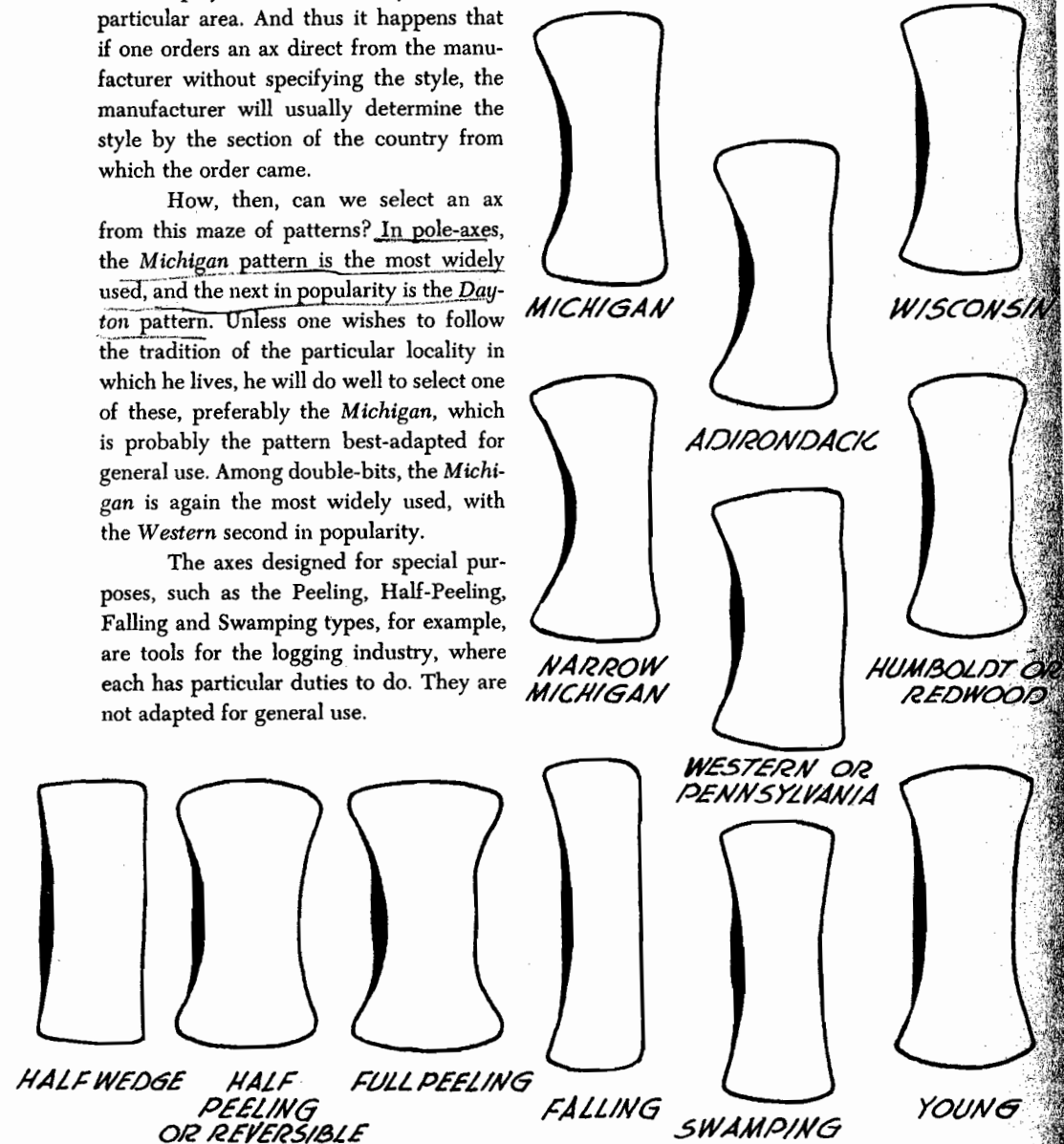

## HANDLE WITH CARE

LIKE AN AUTOMOBILE with a faulty steering wheel, an ax with a poor handle is apt to get out of control and is never dependable. Cheap handles tend to break, split, warp, and fur up, and they seem to do these things just when the ax is needed most. Get the best helve that is made, for the best is none too good. This means to get one of seasoned *second-growth hickory* (or of *hard maple*, as second choice) —avoid those that are not so labeled, no matter how beautifully they may be painted or lacquered. Examine the grain to see that it is straight.

Pole-ax handles are usually curved (Figure A), whereas those used on



double-bitted axes are straight (Figure D). Occasionally a straight handle is seen on a pole-ax (Figure C) but these are not common.

At the end of an ax handle is a knob shaped to fit the hand. The usual type is the familiar *fawnfoot*, seen on practically all pole-ax handles. The *scroll end* is seldom used on big axes. Straight handles have a slight *swell* at the end.

An ax handle should be absolutely smooth so that it will slip in the hand with the utmost ease. All ax handles have a smooth finish when bought, and some are lacquered to give them increased slickness. In time even a good handle may fur up when wet so as to become rough. This may be remedied by soaking the handle in hot water until the grain stands out, allowing it to dry, and then sanding it down smooth. Then give it repeated coats of linseed oil.

Should a handle warp, throw it away and get a new one. In storing an ax for a long time, lay it flat on the floor to prevent warping.

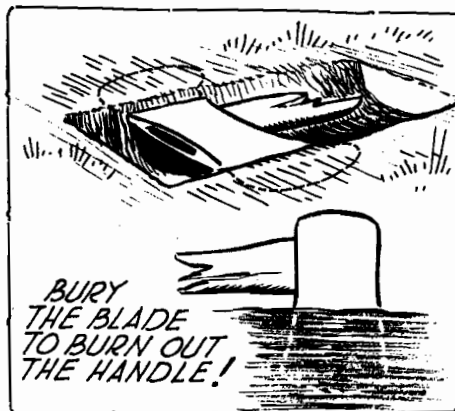
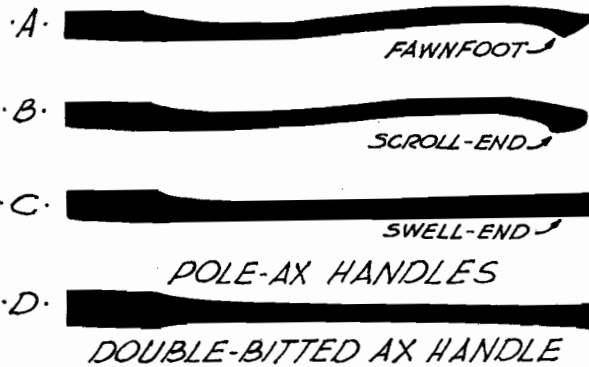

## THE HANG OF IT

CHECK THE HANG OF THE AX before you buy it: Sight down the cutting edge to see if it is in exact line with the end of the handle—if not, discard it. Then place the ax on a table so that both the cutting edge and the end of the handle touch the surface. If properly hung, the cutting edge will touch at a point one-third from the heel, as shown in the drawing. Although tastes may vary, this is the standard and accepted hang for full-sized axes.

In pulpwood logging, however, where the pulpwood ax with a 28-inch handle is used, the preferred hang is with the cutting edge touching at the middle. But even here, the standard hang would be acceptable.

*Removing a Broken Handle.*—Thrust the blade in the ground and build a little fire over it. If it is a double-bit, dig a small ditch, place the ax crosswise of it and cover the cutting edges with earth, then build a fire in the ditch. The earth protects the temper.

*Hanging a New Handle.*—First saw off about one inch from the end of the fawnfoot so as to provide a blunt surface on which to pound. Split the other end so as to receive the wedge, then drive this split end into the eye of the ax by pounding on the fawnfoot. Here is a secret that will make the wedge stick: When the wedge is driven in cut a groove crosswise of it as in the drawing, and then continue driving it in until the groove disappears in the end of the handle. Then *break* the wedge off—it will break at the groove, and the handle of the ax will swell over it and hold it securely. The wedge should be of seasoned hardwood.

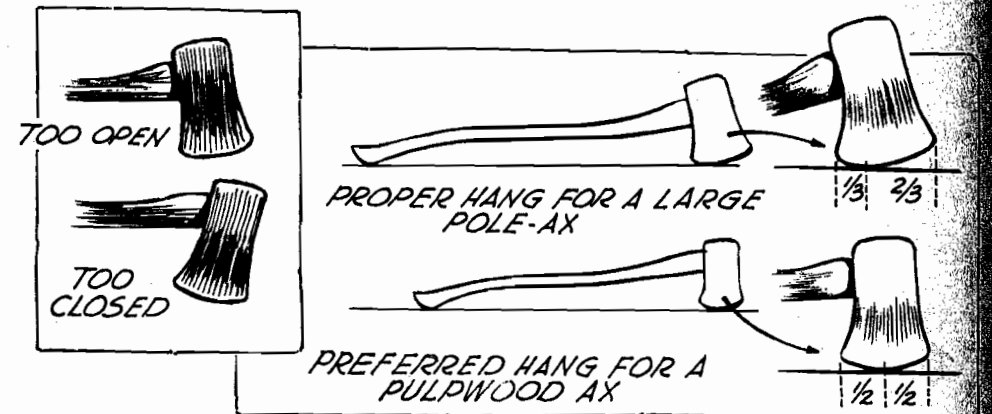
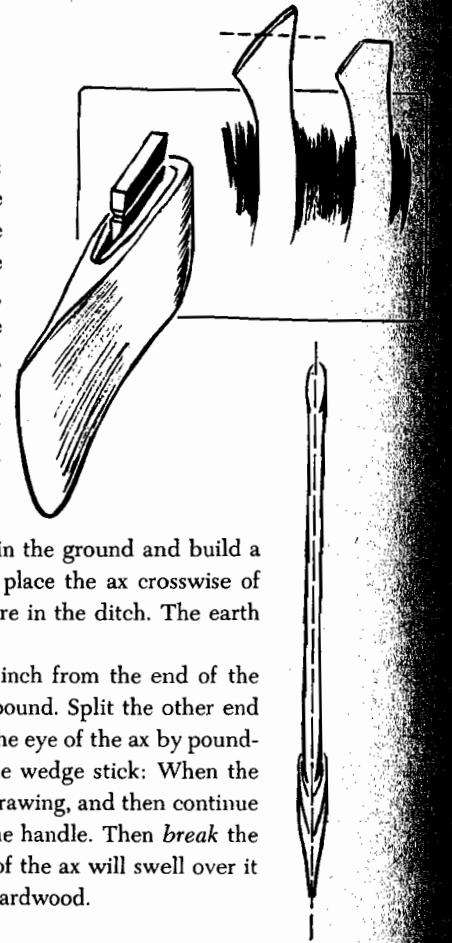



## WHOSE FAULT?

WHEN AN AX CHIPS, we are quick to blame the ax... to condemn not only the ax, but the manufacturer and all the axes that bear his name. Now it may well be that the ax was defective, but it is more probable that the fault rests with the axman. And one glance at the ax will settle the matter, for a sound ax breaks in a different way from a faulty one.

Note the drawing of the ax at the top of the page. This was a sound ax, used by a careless axman. The breaks in it have curved edges; they are small rounded nicks. Such nicks as these are caused by striking an object harder than the ax can cut.

Now look at the picture of the faulty ax below it. Note that these breaks come to a sharp point. Such breaks are caused by cracks resulting from shrinkage after the steel hardened. Any manufacturer of warranted axes will replace an ax that develops such breaks, but will not replace ones with breaks of the type shown in the upper drawing.

Axes are made of steel, and steel will break if struck against too hard an object. They are made to cut wood. If a good ax is handled carefully, it will not break:

1. Never let the edge touch the ground—even a pebble may chip it. Mattocks are made to use in the ground, not axes.
2. Avoid hemlock and balsam knots—they are glass-hard and will break any ax. Never chop any kind of a knot unnecessarily—cut around it if possible.
3. In cold weather, warm the ax before using. Steel with frost in it is very brittle. Don't get it too hot—the test is if you can touch it with your hand.



WARM YOUR AX  
BEFORE USING IT  
IN COLD WEATHER

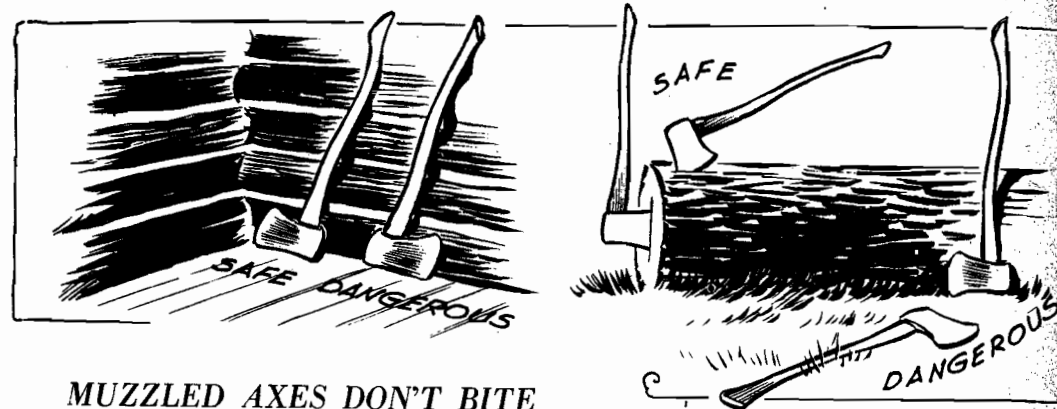
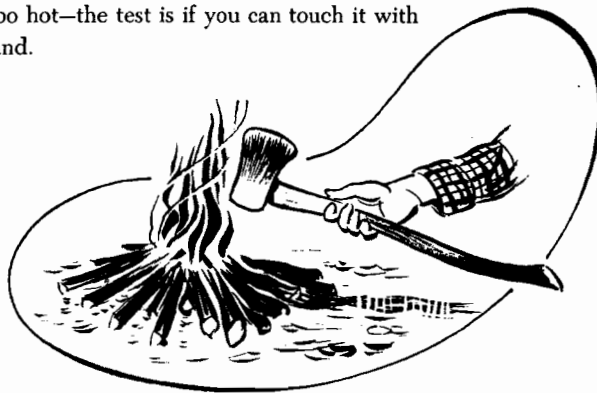

## MUZZLED AXES DON'T BITE

ONLY THE MAN WITH A HOE-DULL AX is careless about where he puts it. Kicking a sharp ax is like touching a razor blade. That keen edge must be kept covered up:

1. When through with a pole-ax, stick it in a log or stump—never lay it down or lean it. (Don't leave it stuck long, however, or it will "sweat" and become dull.)
2. A double-bitted ax should never be stuck in a log so that one bit flares out dangerously. Stick the head under a log, or first drive one bit into a small piece of wood and then stick the other bit in the log.
3. Indoors, place the pole-ax in a corner with the blade pointing inward. A double-bit should be placed in a corner with both blades touching the walls.
4. In carrying a double-bit, grip the handle close to the head and carry at the side, blades up and down. Grip a pole-ax in the same way but with the blade pointing outward. If you stumble, throw the ax.
5. Get the muzzling habit. If the ax has a sheath, use it.

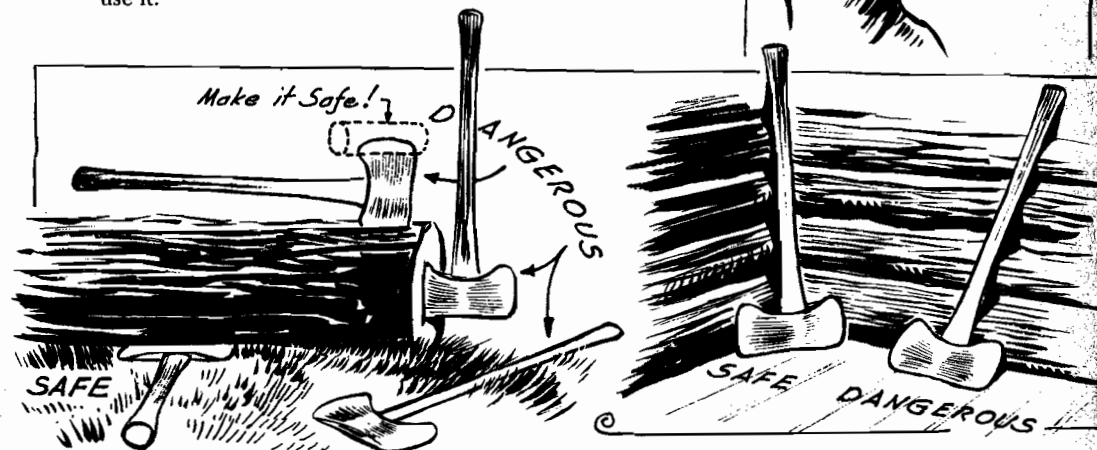
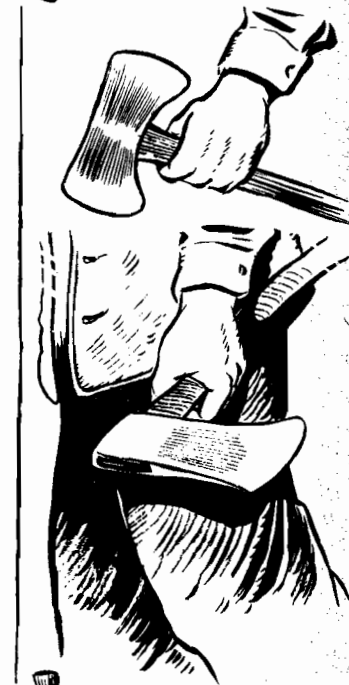



ROUND AX STONE

## GIVING IT TEETH

AN AX IS THE EASIEST OF TOOLS to sharpen. An 8-inch mill file and a round ax stone are needed, both of which should always be handy.

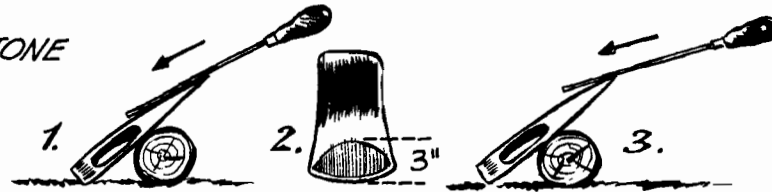

1. First file down the *flat surface* of the blade: Place the file flat on the blade at a point a half-inch from the edge (Figure 1), and push it directly away from the edge. Lift the file off after each stroke, filing only on the forward motion. The file should always be kept at right angles to its cutting edge.

2. Aim for the fan-shaped effect shown in Figure 2, filing back for a distance of three inches from the cutting edge at its middle point.

3. Now file the edge: Place the file on the very edge (Figure 3) and make *rounded* strokes away from the edge to a point a half-inch back from it.

4. Next hone the ax with the round ax stone. Grip the ax as in Figure 4, and rub the edge with the stone, using a circular motion from the toe to the heel. Start with the rough side of the stone and repeat with the fine side. Wet the stone.

5. Hold the ax as in Figure 5 and repeat on the other side.

The ax should now be razor-sharp. Each time it is resharpened, the flat face of the blade should be filed before the edge is touched up. The importance of this will be seen in the next chapter.

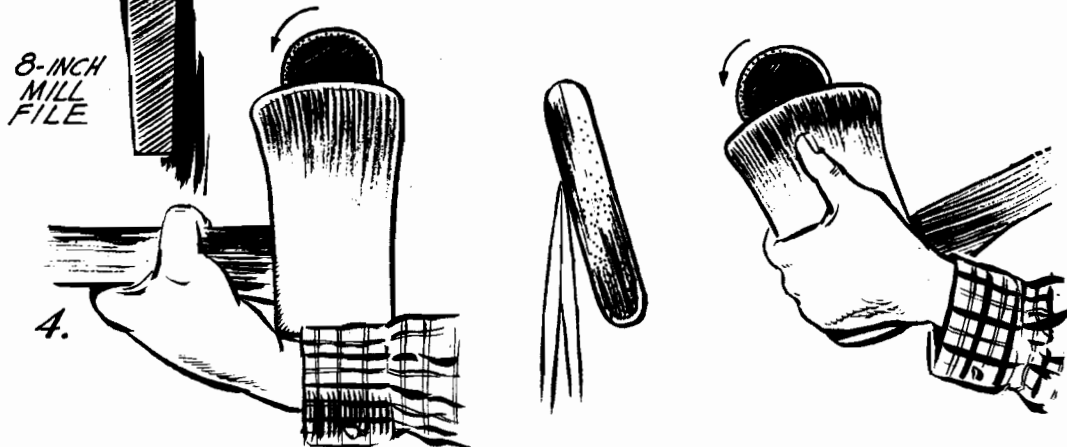

8-INCH  
MILL  
FILE

## FOR SPEED AND SAFETY

A DULL AX is a thing to be feared. Instead of cutting in, it tends to glance off, and herein rests the story of most accidents, for when an ax glances off it flares out wildly and is beyond the control of the axman. Both for speed in chopping and for safety, an ax should be kept razor-sharp.

The need is not only for a sharp edge, but for a blade that is thinned down proportionately. A new ax is usually ground to proper proportions when it is purchased, but when you resharpen it, if you merely file the bevel of the cutting edge without thinning the blade correspondingly, the blade will soon become stunted and

stubby. This is apparent in the bit marked "too thick." That kind of an ax is both inefficient and dangerous. On the other hand, axes are often ground *too thin*, even to the point of giving them a convex grind as seen in the drawing of the blade marked "too thin." Such an ax may break under ordinary chopping.

An *ax-bit gauge* dispels all these worries in sharpening an ax. This is a thin sheet of metal with a slot cut in it of the exact thickness the blade should have. By slipping it over the edge of the ax, one can tell at a glance whether the bit is too thin or too thick. These gauges are not on the market, but can easily

be made from a sheet of soft steel, using the pattern shown at A, which is the exact size.

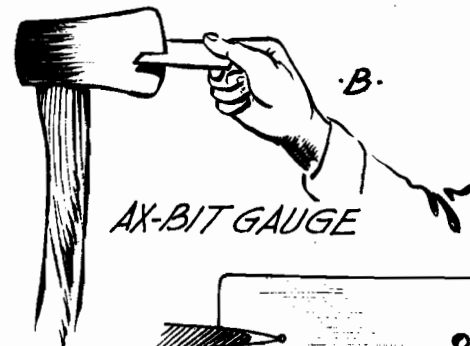

AX-BIT GAUGE

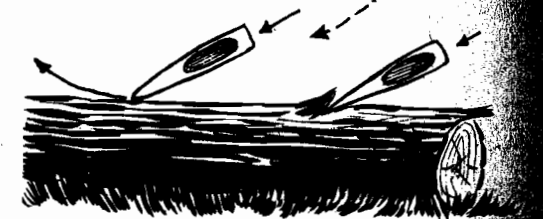
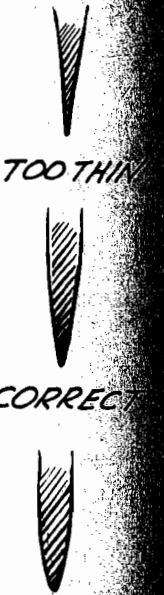

BLUNT AXES GLANCE OFF  
PROPERLY SHARPENED ONES  
DIG IN!

## THE OLD GRINDING WHEEL



IT IS WHEN AN AX is in bad shape and in need of much grinding that the services of the grindstone are sought, but once in shape again, a file is all that is needed to keep it so. Those who touch up their axes regularly seldom need the grindstone.

1. *Keep the grindstone wet.* A dry stone will surely ruin an ax. The temper of its thin edge is easily drawn by the heat of grinding, the steel becomes softened and the ax rendered worthless. For the same reason, *turn slowly*—speed creates too much heat, even when the stone is wet.

2. Turn the wheel so that it moves *toward* the ax, not away from it.

3. Hold the blade of the ax *crosswise* of the stone as in the drawing, so that the stone will stroke it at right angles to the cutting edge. If held as in the picture of the wrong way, a groove will be worn in the middle of the stone so as to ruin it for future use.

4. Follow the same routine as in sharpening with a file, first grinding the flat surface of the blade, then rounding off the bevel of the edge. Read the instructions for filing on page 16—the procedure is the same whether with file or grindstone.

5. *Grind gently*, keeping an eagle eye on the bevel of the bit, so as not to alter its original lines.

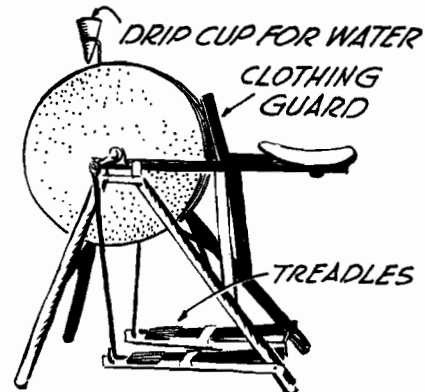

## FOREHAND SWING



## BACKHAND SWING



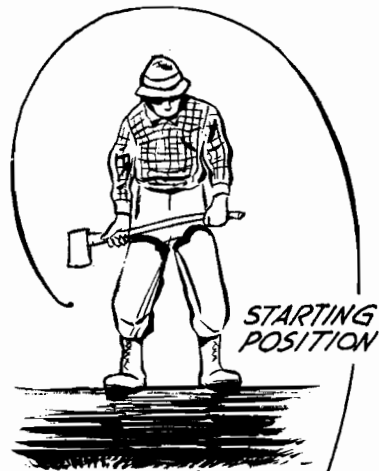

STARTING POSITION

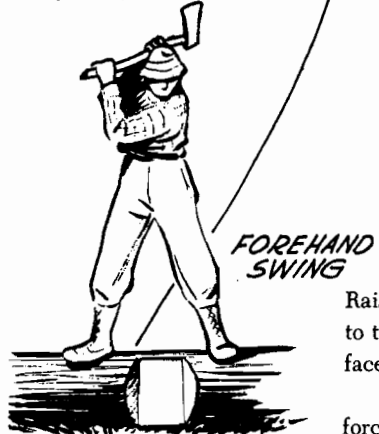

FOREHAND SWING

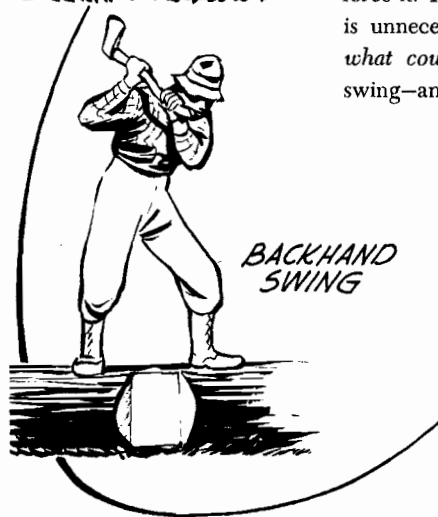

BACKHAND SWING

## CHOPPING

AN EXPERT in the art of chopping is not born in a day. Full mastery comes only after one has had an ax in his hands for years. But the fundamentals are clear, and can be picked up by anyone, and once in hand, will do much to make the big chips fly.

*Holding the Ax.* —Grasp the ax with the left hand just above the knob at the end of the handle, and support it with the right hand about three-fourths of the way up the handle. With the ax held in this way, crosswise in front of the body, we are ready to start chopping.

*The Forehand Swing.* —This is to cut the right side of the notch. Raise the ax up behind the right shoulder as in the picture. The hands are still in the same position as at the start. Now bring it down onto the log with a natural, easy, swinging motion, sliding the right hand down the handle as you do so, so that both hands are together at the end of the stroke. Raise it again, *sliding the right hand up as before*, and start the next swing. The right hand thus slides up and down, while the left remains stationary.

*The Backhand Swing.* —This is to cut the left side of the notch. Raise the ax over the *right* shoulder as before, but lean the body well to the left, so that the ax can be brought down in line with the left face of the notch.

*Chop Gently.* —Above all, take it easy. Never drive the ax or force it. The weight of the ax is sufficient to do the chopping. Force is unnecessary, but worse—it destroys your aim, and *accuracy is what counts*. Swing with a normal, natural, unforced, rhythmic swing—and watch your aim. That is what cuts wood, not brute force.

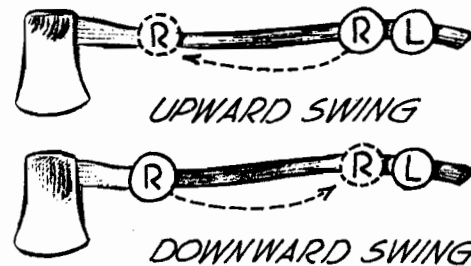

## HIGH, LOW, AND IN THE MIDDLE

THE POSITION from which to chop a log is *standing on top of it*. The reason is simple: A log is chopped by cutting a V in one side of it, and then cutting another V in the opposite side so that the two meet. Of course if the log is small enough to be rolled over, one can stand to one side and chop a V in the top of it, then roll it over and finish on the other side. But if it can't be rolled, which is usually the case, there is no choice but to mount it. from which position you can chop one side, then turn around to chop the other. This is always the best position anyway if the log is large enough to provide footing. If it is tipsy or slippery, rough up footholds on it.

Peter McLaren, of champion chopping fame, first put into words the chopping technique that forms the basis for our motto, "high, low, and in the middle." Standing on top the log, first make three forehand strokes, then three backhand strokes, following the sequence shown in the drawing: the first stroke should strike the log at the *top* edge, the second at the *bottom* edge, and the third in the middle. This is the routine of good chopping—*high, low, and in the middle*.

There is good reason for this: Not until the wood has been cut at the top and bottom can the big center chip be thrown out, and moreover, if the middle stroke is made first the ax will bind and freeze in the solid wood. The top stroke should be so made that the corner of the ax blade extends above the log, and the bottom cut so that the corner extends below—this to prevent the ax from sticking. After the wood has been cut at the top and bottom the middle blow will loosen the center chip easily and the ax will be freed. It is the last stroke in the series—No. 6 in the drawing—that throws the chip to the ground.

Of course in actual practice it will not work out just this way unless every blow is perfectly placed. If the blows are poorly aimed, several extra strokes may be needed. And again, if the log is big, several center strokes may be needed instead of one. But the high-low sequence should be followed regardless.

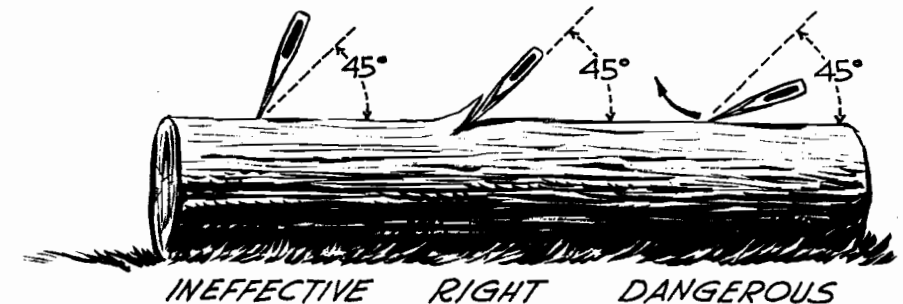
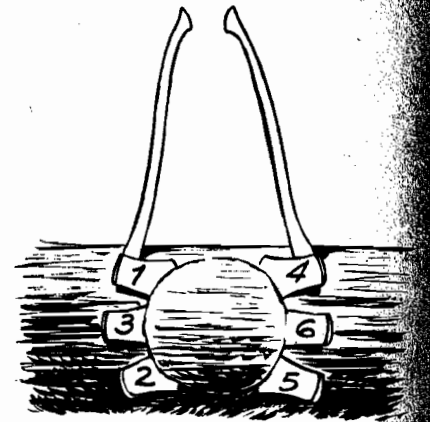

## HOW BIG IS THE COW'S MOUTH?

IT DEPENDS ON THE SIZE OF THE LOG. The commonest mistake is to make it too small, with the result that before the center of the log is reached the V becomes so pinched that the chips cannot be thrown out, and a larger notch must be started.

*The width of the cow's mouth should be the same as the width of the log.* This is really just a trifle wider than necessary, but it is an easy rule to remember and a safe one always. Actually, a 10-inch notch is wide enough for a 12-inch log, but it is better to err on the wide side than the narrow.

Mark the width of the notch on the log before starting, then begin chopping the V, aiming it at the center of the log, so that when the V comes to a point the center of the log will be reached.

*Watch the angle at which you chop.* Only those blows struck at a slantwise angle will bite in. The picture at the bottom of page 19 shows it: To swing the ax

straight at the log will cut no wood—the ax will rebound and merely dent the log. At an angle of 45 degrees or a trifle more the ax takes hold and bites deep. *But beware of glancing strokes.* A blow swung at less than 45 degrees is apt to glance off and send the ax flying wide and far. More accidents result from these glancing strokes than from any other cause. A sharp ax helps, but watch your angle!

Give the ax a little twist each time it hits, to prevent it from sticking and to loosen the chip. It is this twist that bursts the chips and throws them out. With experience it becomes automatic.

The method of cutting the notch changes when the log is more than a foot in diameter. The plan to follow is shown at B: first chop a 10-inch notch, then enlarge it by knocking off chips from one side of it. On an extra big log, enlarge it by chopping chips from *both* sides of it as indicated in C.

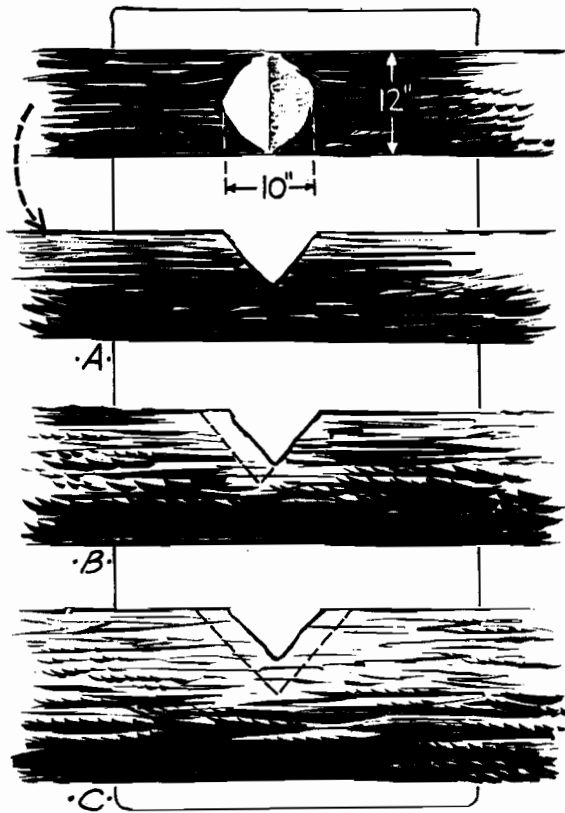

**FIRST HIGH,  
SECOND LOW,  
THEN IN THE MIDDLE.**



## MISERY WHIPS

IN THE TIMBER COUNTRY the loggers spend many more hours a day with their "misery whips" than with their axes. Indeed, to all who work around logs, even if only occasionally, the art of sawing is every bit as important as that of axmanship. The large logging saws are of two types—the two-man and the one-man.

The two-man crosscut saw (usually referred to merely as a *crosscut*) has a detachable handle at each end, and as its name implies, is operated by two men, one at each handle. Some have straight backs, and others have swaybacks, but the cutting edge is always round-breasted as shown in the drawing. While these can be had in lengths from 5 to 14 feet, the usual size is 5½ feet. The handles are attached

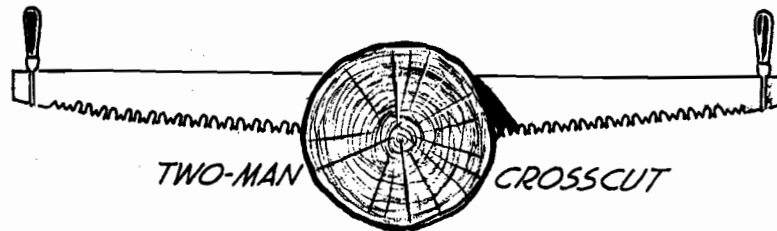

by slipping the loop over the end and twisting. A twist and a jerk will remove them, an essential feature, for in felling trees the handle must be yanked off in a flash.

The man in the picture (right) on page 23 is using the one-man crosscut saw, called a *cedar saw* because of its use in years past in cedar logging. These are 3½ feet in their standard size, and resemble in appearance an overgrown carpenter's saw. In addition to the typical saw handle, a supplementary handle is also provided called a *point handle*, which can be attached just above the regular handle, or at the end of the saw so as to make a two-man saw of it, or left off altogether. Such saws are used in felling cedar and other small softwood trees, and in bucking them up. In recent years they have been largely replaced by the bow-saw (page 26).

The standard tooth patterns seen in crosscut saws are the *tuttle tooth* and the *perforated lance tooth*. The tuttle tooth is more widely used.

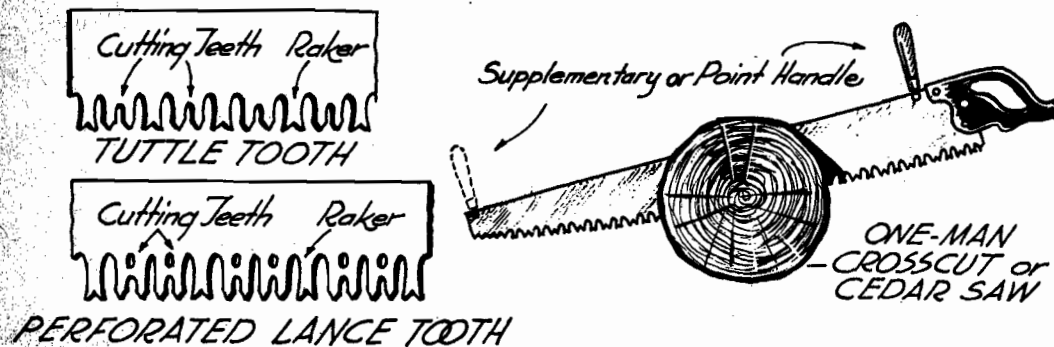

**BUCKSAW** (upper left)  
For sawing firewood

**CEDAR SAW** (upper right)  
One-man crosscut  
for bucking softwood

**CROSSCUT SAW** (right)  
Two-man saw for  
large log work

**BOW-SAW** (bottom)  
For pulpwood cutting  
and small log work

## DON'T DRAG YOUR FEET

MANNING THE BIG SAWS is simple enough, much simpler than handling an ax, but lest "you drag your feet," there are important points to watch:

1. Elevate the log if possible so that the end is free. Note in the pictures on page 23 that a supporting log is placed underneath, just back from the saw. This prevents pinching, because the weight of the log spreads the kerf. If the log is too heavy to lift, saw her "as she lays" and drive a wedge in the kerf to prevent pinching.

2. Remove all thick bark with an ax from the spot where you intend to saw. Thick bark is hard and dulls the saw.

3. Squirt kerosene on the saw for lubrication.

4. Take a good stance, with feet well apart.

5. Pull the saw toward you with long even strokes of the full length of the saw. *Pull it toward you—that, and nothing more:* do not push it back—that is your partner's job. Pushing buckles the blade and doubles your partner's work. On the backward stroke, relax your grip and thrust your arms forward in rhythm with the saw; thus relaxed, your hands cannot push the saw. And do not wrestle the saw to force it downward—pull it with just enough downward emphasis to keep the teeth in the wood.

6. *Keep the saw straight* so as to cut a straight, even kerf. Crooked kerfs pinch.

7. When the saw begins to pinch, drive a wedge in the kerf. When it is nearly through it will probably pinch anyway, wedge or no wedge, making long strokes impossible. Then take short, quick strokes of about a foot in length until the log drops.

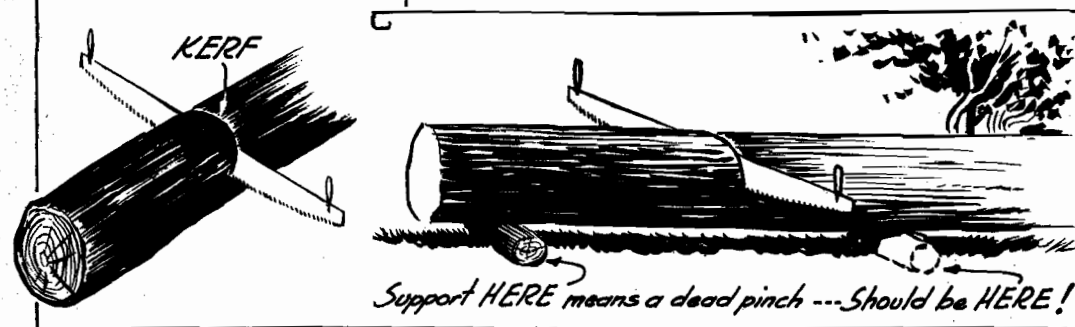
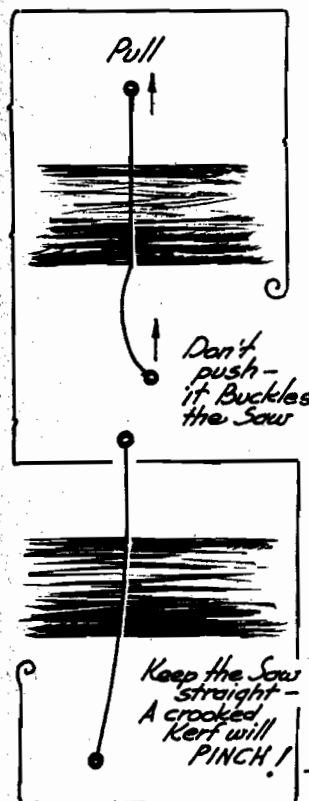

## OLD-FASHIONED BUCKSAW

A BUCKSAW is used for bucking up small logs into lengths. It is an intimate part of the woodpile that feeds the stove and fireplace, for the making of firewood is one of the bucksaw's chief functions.

The time-honored bucksaw with its familiar wooden frame, which has graced the woodpiles of America since pioneer days, is seen in the hands of the man in the photograph (upper left) on page 23. Its wooden frame is collapsible, assembled in five minutes. The metal rod across the top is equipped with a turnbuckle, and by twisting this the blade can be given the necessary tension. The blade should be stretched with all possible tension so as to remove all play. Blades not properly tightened tend to buckle, vibrate and chatter.

Time changes all things, and while the old bucksaw has served well these many decades, it is fast giving way to the modern bow-saw or Swedish buck-saw described in the next chapter, with its metal frame and its faster-cutting teeth.

Its chief shortcoming rests in the blade with which it is usually equipped and with which it works best, which has a series of simple V-teeth. This cuts wood all right, but not with the zip and zest of the bow-saw blade with its coarser teeth. These more highpowered blades can be inserted in the bucksaw, but the wooden frame often has difficulty in providing the necessary tension for them.

Styles change slowly, however, and the old bucksaw will doubtless continue to make firewood on the woodpiles of America for many a long year to come. But its usefulness is confined to the woodpile, while its faster-moving offspring is capable of going out to the woods to fell trees and tackle all log work on timber up to a foot in diameter.

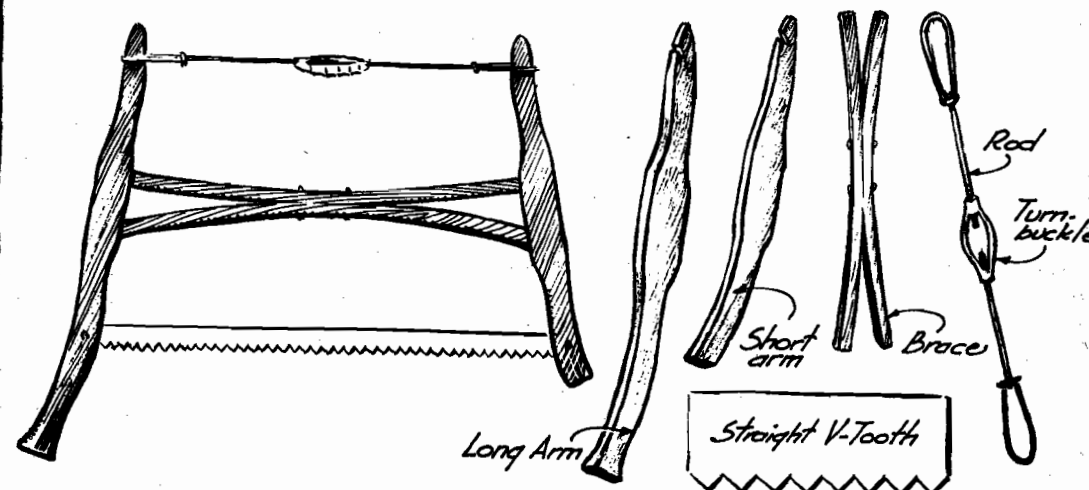

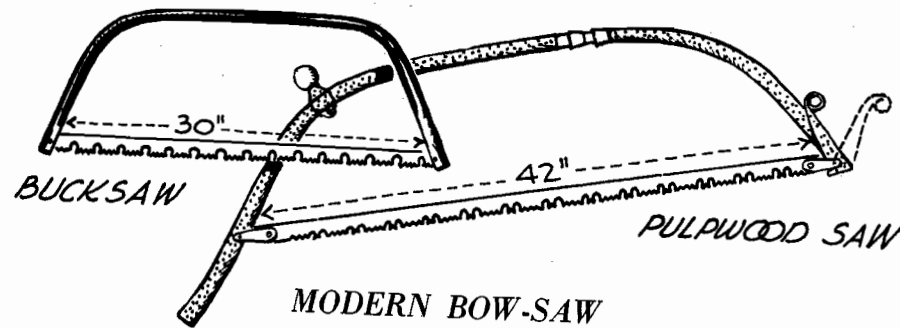

AS COMPARED TO ALL OTHERS of its size it is indeed a dream saw; in its class it has no match. Not only has it just about driven the wooden bucksaw out of the woods, but it has quite generally replaced the one-man crosscut or cedar saw as well, for use on all timber up to a foot in thickness at the stump.

Its superior merit rests first in its frame, which is of hollow steel tubing, is exceedingly light, and gives terrific tension to the blade. But frames do not cut wood, which leads us to the second point of superiority, the business edge of its cutting blade, which is the nearest thing to a buzz saw in the speed and ease with which it zips through timber. As compared to its savage teeth, the V-teeth of the old-style saw reminds one of the horse-and-buggy days. But this takes us back to the frame again, for a less powerful frame would not give the necessary tension for such powerful teeth. But be it known that there are several makes of these saws, with several tooth patterns, some better than others. A tooth pattern particularly to be recommended is *four cutter teeth and a raker*, the pattern of which, shown in the drawing, should be firmly fixed in mind so that it can be readily recognized. The purpose of the *raker* is to clear out the sawdust from the kerf. Another excellent tooth pattern is known as the *Bushman*.

This type of saw is variously called a *bow-saw*, *Swedish saw*, *pulpwood saw*, or in the vernacular of the lumber camps, a *Swede fiddle*, but to those who use it most it is just plain *bucksaw*.

These bow-saws come in various lengths from 24 to 48 inches. As a saw to replace the old-style bucksaw for cutting firewood, the 30-inch size is ideal. For felling trees and for bucking up logs, the 42-inch size is recommended, which is the size used in the pulpwood industry.

The bow-saw was introduced into the American woods from Sweden in the 1890's, and like all new things was slow in "catching on" at first. But today it reigns supreme in the pulpwood camps.

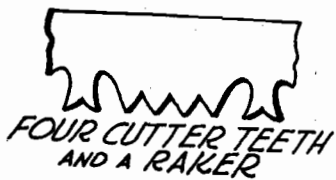

### ITS TEETH NEED BRUSHING

THE PINT BOTTLE you see sticking out of a logger's hip pocket contains coal oil (kerosene) to be squirted on the saw to lubricate it, and to cut the resin in ever-greens. The neck of the bottle is filled with straw or pine needles to make the squirter. The hip-pocket habit is a bad one, however, because the pants get wet and this chafes and irritates the skin. The better way is to wire a hook on the neck.

The thin strip of wood you see on his crosscut saw as he goes to work is a *saw guard*, which performs the same functions as a sheath on an ax, muzzling the sharp teeth so that the saw can be carried with safety, and protecting the teeth from being dulled. Be sure your saw is equipped with a guard when you buy it, and keep the guard on *always* when not in use. Make one if need be, by cutting off a 3/4-inch strip from the grooved edge of a piece of tongue-and-grooved lumber.

Saws, like axes, need sharpening regularly, but unlike axes, they require the experienced hands of the Old Squint Eye. The logger who uses his saw constantly brushes up the teeth at least once a day, and turns it over to the Squint Eye for a complete sharpening at least once a week. Everyone should learn to brush up the teeth, but the how of it is a story too long to be told here—take your saw to an expert sharpener and watch him work—ask questions, and learn.

The daily touching up involves two processes: First, the rakers (page 28) must be shortened or *jointed*, for it is necessary that they be a shade shorter than the cutting teeth, in crosscut saws perhaps 1/64-inch for softwood, and 1/100-inch for hardwood. This is done in a flash with a *raker gauge* which when set to the proper length, is slipped on the raker and a file run over the ends of the raker points. Next, each tooth is sharpened with a 6-inch mill file, care being taken to retain the original shape of each.

Complete sharpening involves, in addition, *setting* the teeth or bending them to the side. Proper setting is very important. Softwood requires more set than hardwood, and if one's saw does not work properly, it probably does not have the proper set for the kind of timber being sawed. Setting requires special tools and skill.

Fill the neck with Straw or Pine Needles to make a Squirter





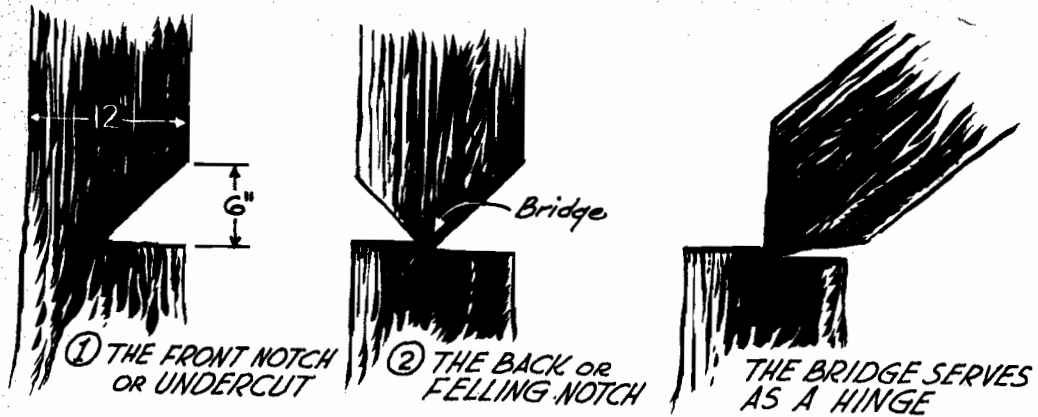

### FELLING WITH AN AX

1. First, cut the front notch or undercut, or *cow's mouth* as the lumberjacks call it. The tree will fall in the direction of this notch. The width of the notch should be *half the width of the tree*—mark it before starting. When the notch comes to a point, the tree should be cut halfway through.
2. Next cut the back notch directly opposite the first and one to two inches higher. This is the felling notch that will send the tree toppling down. It is cut in the same way, and just before it comes to a point the tree will go crashing down in the direction of the first notch.
3. In chopping the notches, the same routine is followed as in chopping a log on the ground: there the rule was “high, low, and in the middle”—here it is “near, far, and in the middle.” The first stroke is on the near side, the second is on the far side, and the third, or as many more as necessary, in the middle, always working from the sides inward (see page 24). First chop the top edge of the notch in this way and then the bottom. It is the bottom strokes that remove the chips, and so the ax should be twisted with each stroke so as to burst the chips.
4. Cut the tree as low as possible. High stumps waste wood.
5. If it is a big tree, the notch is cut as in the lower drawing, by chopping two small notches, then knocking out the block marked X.
6. In the way of the lumberjacks, keep your mouth open a little as you swing, and grunt “Huh” as the ax hits. This keeps you relaxed and otherwise seems to help.



### WHICH DIRECTION?

DECIDING IN WHICH DIRECTION to fell a tree requires study—study of the tree itself, and of the surroundings—for each tree should be felled according to plan, carefully worked out before a blow is struck.

1. *Drop it in a clearing if possible.* The worst is that it get lodged in another tree, for the task of freeing it will then be difficult and hazardous. Do not attempt to drop it between two trees standing close together because the branches are apt to interlace and hold it fast. If there are trees in all directions, fell it toward a smaller one which will be apt to give and let the tree bump through and down.

2. Almost every tree has a slight lean, or has more foliage on one side. *Drop it in that direction if possible.* It is the direction in which the tree will tend to fall anyway, and advantage should be taken of this. One cannot determine the lean while standing under it. Get away from it, walk around it, and use your ax handle as a plumb line.

3. *Drop it with the wind if possible.* Even a slight breeze exerts great pressure on a tree, for the foliage acts as a huge sail to catch the wind. If this is impossible, and it is a big tree and the wind is strong, better wait for a calmer day.

4. In what direction do you want to move the log when it's down? *Fell it in that direction if possible.* Swinging a log in the woods is not easy.

5. If there is a very large and heavy limb extending out low on one side, avoid felling the tree in that direction, for if it should fall directly on this limb, the trunk may break at its middle. The same thing may happen should the trunk fall directly onto a large stump or rock.

These are the factors then that must be considered. If the tree is straight and symmetrical, if it stands in a clearing in all directions, if there is no wind blowing, and you do not intend to move it in any particular direction, it makes no difference where it is felled. But when one or more of these factors enter the picture, decisions must be made before the ax is lifted.



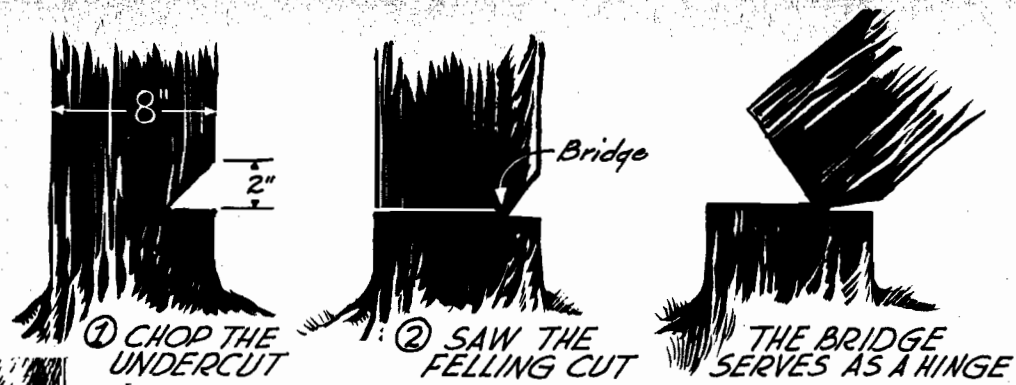

### FELLING WITH A SAW

Don't twist saw  
-it will pinch!

Keep saw  
straight

Barber Chair  
-poor cutting

Flat stump  
-good cutting

DANGER-don't  
saw below notch.  
-Tree will KICK BACK!

1. First, chop the notch or undercut. The tree will fall in the direction of this cut. This notch should be one-fourth the diameter of the tree: an 8-inch tree would require a 2-inch notch.

2. Next, start sawing directly opposite the notch and one or two inches above the lower surface of it. Hold the saw level with the ground so that when the tree falls the top of the stump will be flat. Barber chairs and whiskers are signs of poor workmanship.

3. Keep the cutting edge of the saw even with the notch. When two men are sawing, this is accomplished by each man calling out as the sawing progresses, the number of inches between the saw and the notch on his side. When one calls his number the other answers with his, and if one is farther away than the other the saw is immediately adjusted.

4. To avoid pinching, keep the saw absolutely straight. If it is allowed to bend or twist a dead pinch may result. In cutting big trees, pinching can of course be expected from the sheer weight of the tree, and a wedge will be needed to spread the kerf.

5. Just as the tree starts to fall, withdraw the saw and move off to one side. To do this with a two-man saw, one man untwists his handle and slips it off so that the other can pull the saw through as he turns to leave.

6. Cut the tree as near the ground as possible. It is harder to saw down low but it saves precious timber.

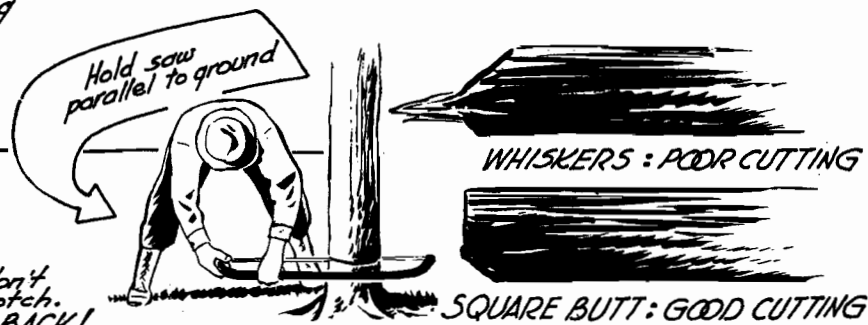

### IF THE TREE LEANS

1. If the tree stands perfectly straight, it should be felled as already described.

2. If the tree has a slight lean in the direction of the fall, it is felled exactly as if it were straight.

3. If the tree has a heavy lean in the direction of the fall, special caution is necessary: cut a deep notch, at least 1/3 the diameter of the tree, then extend the notch to the sides of the tree, making the winged notch pictured on page 34. Be careful not to carry the wings past the middle of the tree, however. Such leaning trees are notoriously dangerous—they are prone to split up the trunk before the sawing is completed, thus imperiling the worker (see page 35). Cutting the notch deeper and extending it to the sides reduces the danger. It is usually safer to fell such trees at an angle to the lean if possible.

4. If the tree leans diagonally to the direction of the fall, the saw should be held at an angle to the notch in the way shown in the diagram. The bridge is thus made narrower on the leaning side, and this tends to pull the tree over in the direction desired. If a wedge is necessary, it should be driven from the angle shown.

5. If the tree has a slight backward lean, it can only be felled with wedges, if at all. Notch and saw as usual, and drive the wedges in deeper and deeper as the sawing progresses. If the tree has a heavy contrary lean it cannot be felled away from the lean at all. All leaning trees are best felled at an angle.

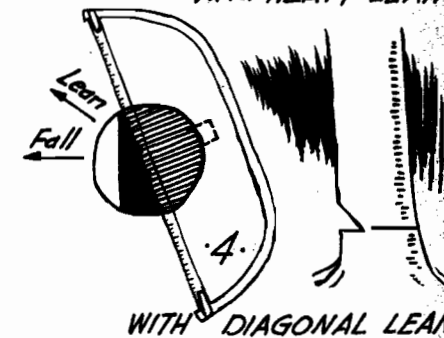
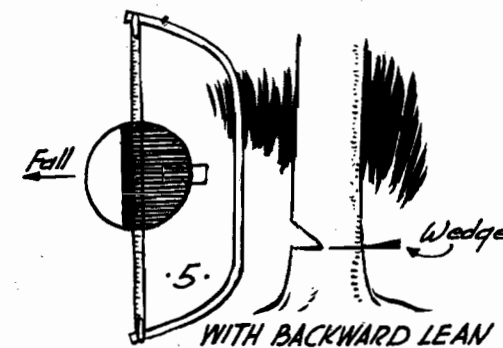
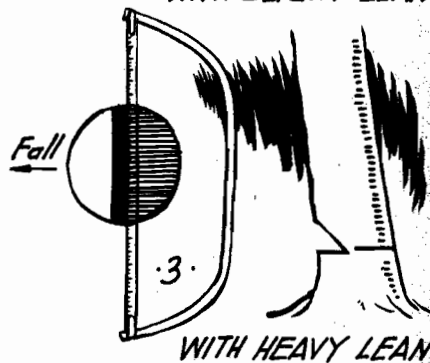
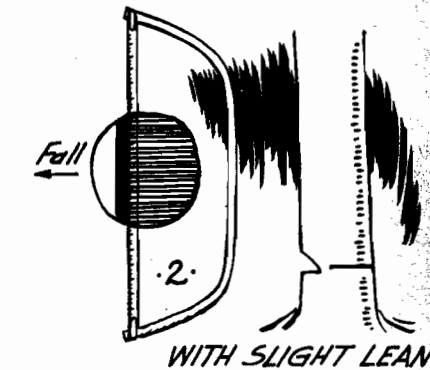
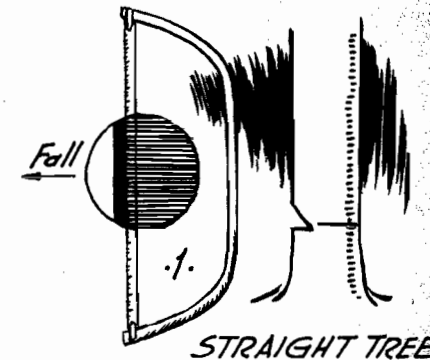

## FREEING A LODGED TREE

TREES DO GET LODGED, in spite of all that can be done to prevent it. It happens in the best of families and is not always an indication of poor felling. Particularly in the cedar swamps and the dense evergreen woods it is an ever-present worry, where the stiff branches refuse to bend to let the tree crash through.

There is no foolproof way to free a lodged tree, always sure to work, but these are the lines of attack:

1. First, try shaking it by pushing against the trunk. If it starts to go, get out of the way fast. *But don't climb up it!* That is a temptation that always seems to lure the greenhorn, and often to his grief, for many a man has been injured that way. It's futile anyway, for if shaking won't free it, climbing it probably won't.

2. If the butt is still resting on the stump, as is usually the case, try prying it off with a pole or by forcing the blade of your ax under it.

3. If it is a small tree, grab it by the butt and drag it directly away from the supporting tree. But for safety's sake, take hold of it at the extreme end only, and do not lift the butt more than a few inches off the ground, sort of sliding it along. Whatever you do, *don't get under it*. For big trees, use a team or a tractor.

4. Felling another tree across it will sometimes free it. The tree should strike it as high up as possible. Never fell more than one tree on it lest a *jackpot* be created, which nothing short of a team of horses can untangle.

5. As a last resort the supporting tree may have to be felled, but this is risky—be sure to stand on the safe side, and give it plenty of room.

Never leave a lodged tree up. It then becomes a *widow-maker* and may come down unexpectedly on some innocent passerby.

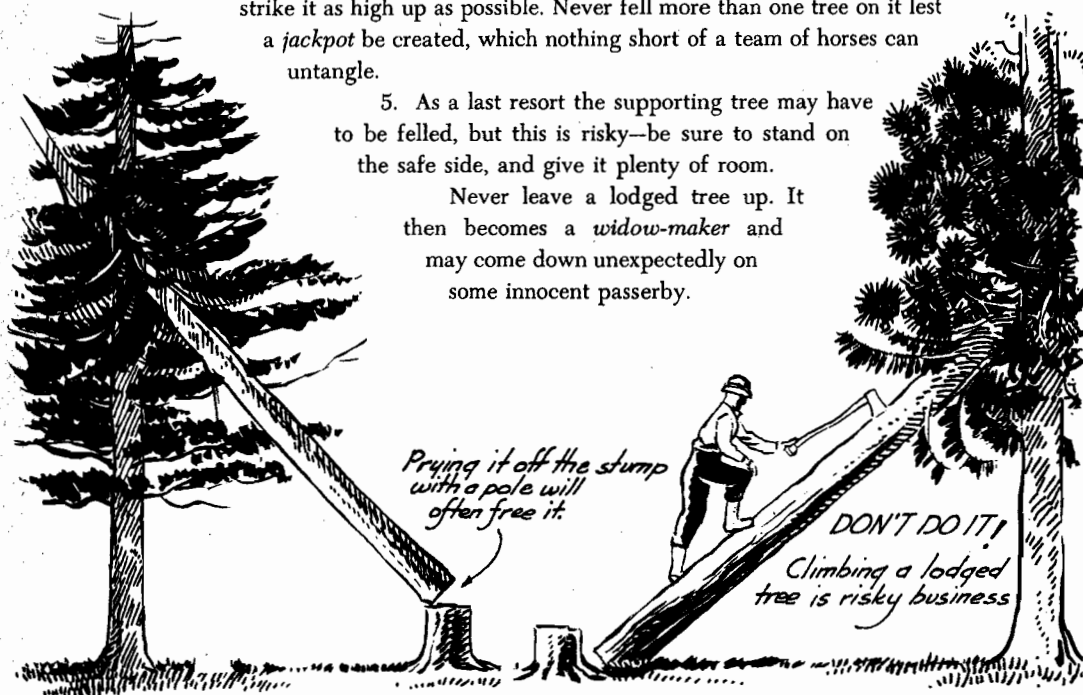

## PUSHING THEM DOWN

Big trees are felled with wedges, which is just another method of pushing, and if there is the slightest question of the tree not falling in the right direction, wedges should be used without fail.

Trees under a foot in diameter, especially evergreens, are usually pushed down with the body. The sawing is stopped just before the tree is ready to fall, leaving a little bridge of uncut wood, then it is given a push, either with the arm or with a pole. This is always safer than continuing to saw clear through, for the bridge serves as a hinge to guide the fall in the desired direction.

A very small tree that stands perfectly straight may be pushed by hand as in the picture, by straight-arming it with the arm at shoulder level and throwing the weight of the body into it. As soon as it starts to go, step quickly to one side. It is easier and always safer, however, to use a pole, because the pole puts the push up higher where it really counts, and permits you to stand farther back out of possible danger. All trees over six inches through, and all trees that lean, should be pushed with a pole, never by hand.

The pole should be held at an angle of 45 degrees, which is the angle at which the greatest force can be applied. A series of short shoves to get it swaying is better than a steady push. Pulpwood loggers carry a *pushing pole* for the purpose, about 2 inches thick and 10 feet long, often with a *pike* (spike) on the end of it, but any similar pole cut on the spot will do. This same pole may be used as a measuring pole for bucking up the logs.

*But mark this:* You may fall and be hurt if your pole slips off the tree. Sharpen the point and work it into the bark before throwing your weight on it, and be careful.

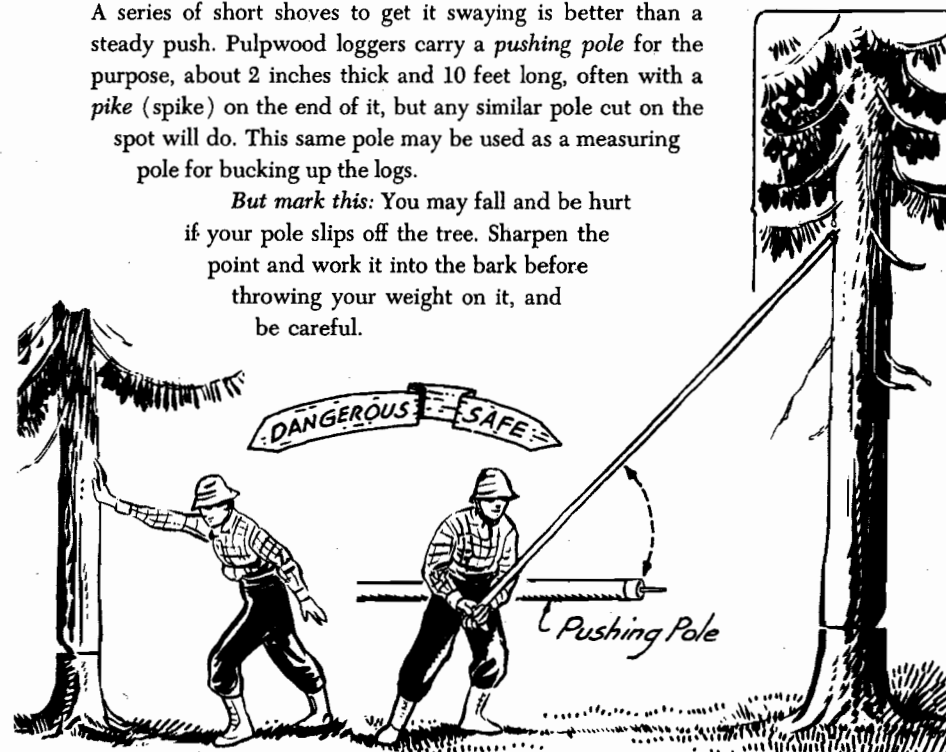

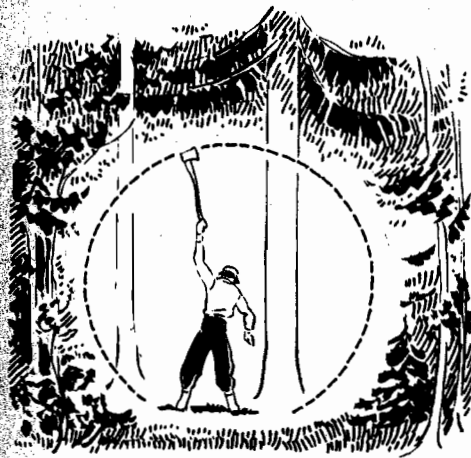

## "T-I-M-B-E-R"—BEWARE

CLEAR AWAY EVERYTHING from around the tree before you start to work—*every branch and sapling, every twig and vine, as far as the ax can reach.* Check by swinging your ax in a circle over your head, then in a circle parallel to the ground. If your ax should as much as touch the tip of a branch, it may be deflected so as to hurt you badly. Novices often start right in to chop with utter disregard for the danger that lurks in every twig. It is such foolhardiness that causes accidents.

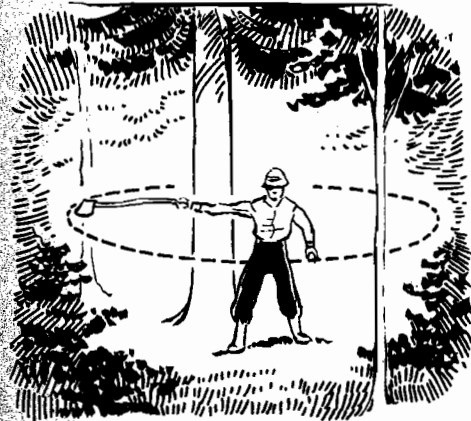

"Timber!" the call echoes through the woods wherever logging is going on—the danger call that warns that a tree is about to crash. Never fail to give it, even if you feel sure you are alone. To fail to do so is criminal neglect.

When the tree begins to sway, move a few yards to one side of it, never back behind it for it may kick back, and never run away from it. Step to one side quickly, and keep your eye on the tree. You know where it is supposed to fall, and if you are to one side of it and close to it, you will have plenty of time to move if it should change direction. But if you run away to where its branches could hit you, you may not be able to get away.

Beware also of the danger that lurks overhead whenever trees are being felled—the *fool-killers* or *widow-makers*, large limbs left hanging in trees, which may crash down at any time and with no call of "Timber" for warning. Keep an eagle eye out for them, and do not work under them. A falling tree may create its own widow-makers, its own branches breaking as it goes down. Such branches are usually thrown back so as to fall near the stump or behind it. Keep your eye on the trunk long enough to make sure of its direction of fall, then look upward for the widow-makers.

A solid tree can usually be depended upon to fall as scheduled, but not so a hollow or rotted one. Always give the tree the ax test to see if it sounds hollow. If so, a *winged notch* should be used.



A WINGED NOTCH SHOULD BE USED ON A HOLLOW TREE

## WATCH OUT FOR KICKBACKS

Yes, watch out for kickbacks! They do not happen often, but when they do they come with the speed of lightning, and are no less deadly. There is no dodging them once they start, and the only way to miss them is not to be in their path. That is why a man never stands behind a tree that is falling.

Kickbacks do not just happen by chance. They all have their causes, and while they cannot always be prevented, they can at least be anticipated. A tree is apt to kick back under the following conditions:

1. *If it strikes another tree in falling:* This often causes the tree to bounce up as it strikes, and to fly backward off the stump. When there is a possibility of the tree striking another, be doubly cautious.

2. *If the tree is felled up a hill:* When the branches strike the ground they spring the tree upward and gravity shoots it down the hill.

3. *If the tree is sawed below the notch:* When it is sawed properly, an inch or two above the lower surface of the notch, a little shoulder is left on the stump which prevents the tree from slithering backwards. To saw low is to invite a kickback.

4. *If the trunk of the tree splits before it is cut through:* This happens in leaning trees and those with a hollow center—beware of them! Remember that such trees should be notched with a winged notch.

But the main rule is, never get behind the tree.

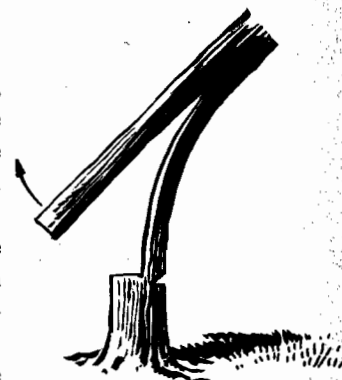

BEWARE OF LEANING TREES—THEY MAY SPLIT

IF A TREE STRIKES ANOTHER TREE IT'S APT TO KICKBACK

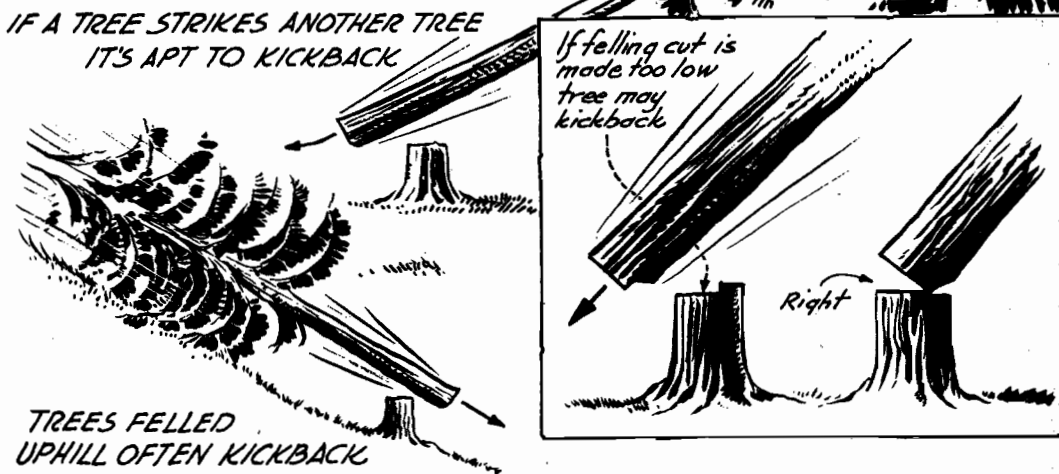

TREES FELLED UPHILL OFTEN KICKBACK

## LOPPING THE BRANCHES

WHEN THE TREE IS DOWN, comes the task of lopping off the branches—a long job or a short one, depending upon how gifted one is with the ax. Here is where deft axmanship counts for speed and for safety. These are the rules which the timber-wise and the experienced follow:

1. Work from the butt of the log up to the top, cutting on the underside of branches. There is good reason for this, for were it done the other way, with the ax swung into the crotch of the branch, the bark would rip loose below the branch and a second swing of the ax would be needed to cut it. An exception is found in the evergreens, where the bark seldom rips, and the branches often extend downward anyway.

2. Always branch from the *far side* of the log, with the log separating you from the ax—this for safety's sake, for the branching is fraught with hazard. In no other task is there such constant danger of the ax glancing off.

3. If the log is so big you cannot reach over it, trim off the top first, then stand on top and clean up the sides.

4. Cut each branch flush with the log, leaving no stub. Stubs make the handling of the log difficult and dangerous.

5. Use both hands on the ax, however small the branch.

6. In trimming evergreens, the dead branches may be *broken* off by hitting them with the butt of the ax or with a pole. Such hard, brittle branches may dull the ax, if chopped. Care should be taken to knock the stub off clean however.

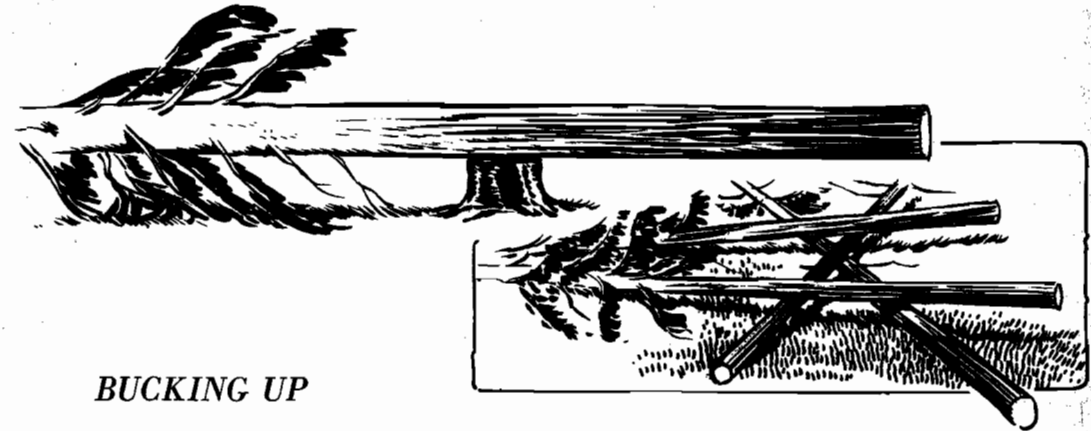
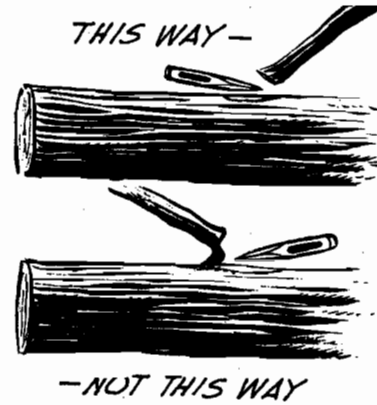

## BUCKING UP

AFTER BRANCHING COMES BUCKING, which is sawing the log into the lengths desired. It should be done on the spot and as soon as the branches are lopped.

First, get the log supported on something so that the end is elevated.

Next, measure the length exactly. Saw logs are usually cut into lengths of 8, 10, 12, or 16 feet, and these are measured with a measuring pole carried along for the purpose. But pulpwood logs, which are cut into 4- or 8-foot lengths, are measured with the saw itself, which is so constructed as to serve this purpose. When the end of the 3½-foot pulpwood saw is hooked over the end of the log, the end of the handle will measure exactly 4 feet, and this end is also useful for scratching the mark on the log. If the saw is of an odd size, a measuring mark can be scratched on the frame and used as indicated in the drawing.

Now to buck up: Take long even strokes, as near the full length of the bow-saw as possible, putting your body into it as well as your arms, and keep a steady rhythm—good buckers saw at the rate of about 60 strokes per minute. It helps to *rock* the saw, dipping the end downward and backward—this helps to clear out the sawdust.

The main hazard in bucking is in placing the hand on the log to steady it. Saws do jump when the kerf is being started, and many a hand is ripped open that way.

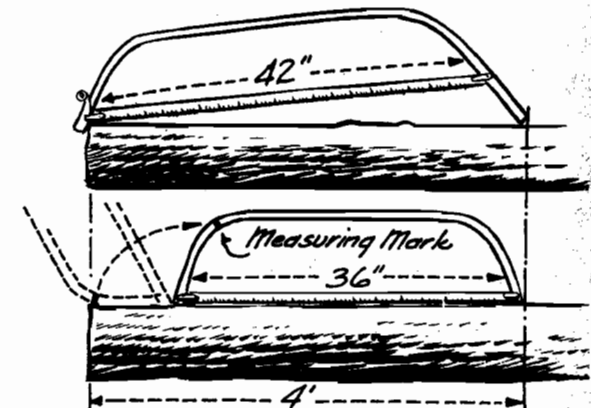
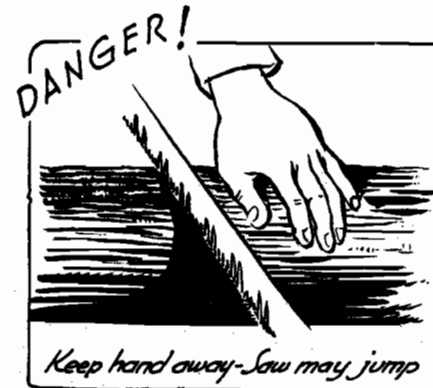

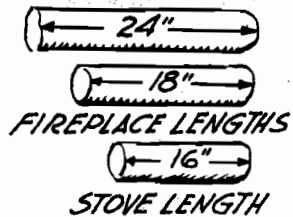

### THE BUCKER'S HORSES

AT THE CAMP WOODPILE we can have the assistance of a sawhorse, which is a great convenience over propping the log up on any old support. Sawbucks are of many types, but they all do two things: they elevate the log to a convenient height for sawing, and they prevent it from moving under the pressure of the saw.

Note the one at A. This is the commonest type. When a sawbuck must be tossed together in a hurry, make it as shown at B. Two poles are driven in the ground to form the X.

A makeshift sawbuck can be quickly made as at C, by driving two poles in the ground to form the X, and wiring them together. The upright post driven in the ground just back of the X helps to steady the log in that it gives you something to push the log against with your foot while sawing.

An excellent sawbuck for big logs is shown in D, made of a 6-inch pole, along the top of which a number of holes are drilled for the supporting pegs. Big logs are rolled up onto the horse.

Handiest for sawing long logs into lengths are the lumberjack sawhorses shown at E and F. That at E consists of skid-poles leaned against a log, up which the logs are rolled into the notches. That at F is more permanent, with notched blocks spiked to the foundation logs.

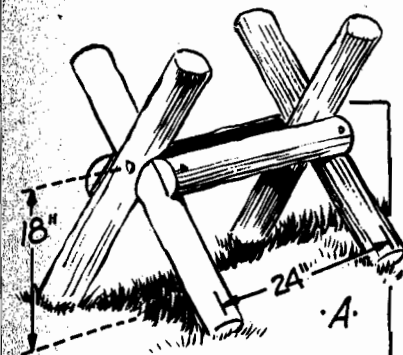

SAWBUCKS FOR SMALL STUFF

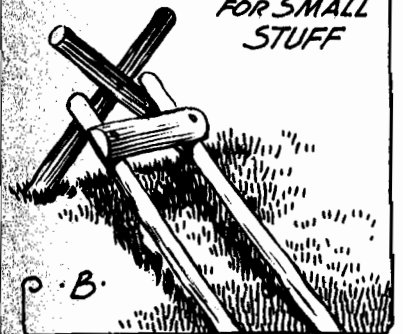

C.

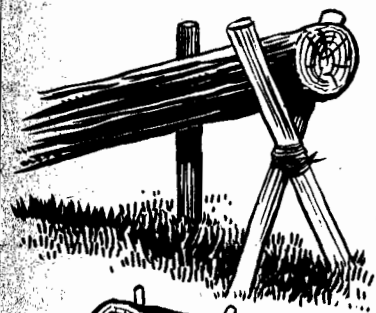

SAWBUCKS FOR LARGE LOGS

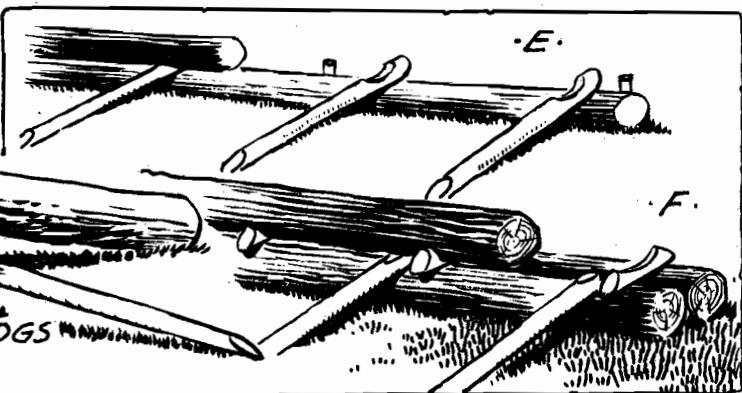

### PEAVEY AND CANT-HOOK

MOST ROMANTIC OF LOGGING TOOLS, they are to the lumberjack as the lariat is to the cowboy, yet few people outside the timber country seem to appreciate their uses or the difference between them.

First, the cant-hook, sometimes called a log-wrench, or in the slang of the timberjacks, a *mooley cow*: it is a movable hook or *dog* on a wooden handle, used for turning or rolling logs. The process of turning the log is called *canting*, hence the name. The handle serves as a lever to give the hook great power, so that one man can turn a log that otherwise would require many men and much straining.

How does the peavey differ? Only in this respect: it has a *pike* or steel point on the end of the handle, as in the picture. This is because the peavey is employed in handling logs in or around the water, whereas the cant-hook is for use on land. The pike or point is used to push the logs as they float in the water, thus making the peavey a sort of combination of cant-hook and pike-pole. The peavey can, of course, be used on land, and often is, but a cant-hook would not do in the hands of the river-jockies who ride the booms and birl the logs and break up the jams in the rivers—there the pointed end is indispensable. The peavey gets its name from Joseph Peavey who invented it in 1858.

One does not really appreciate a cant-hook until he is called upon to move a large log. Like the wrench is to a bolt, these big hooks grip and turn that which hands cannot grasp and arms do not have the power to move. Their uses are many, and their absence would make the moving of big logs well-nigh impossible.

Peaveys and cant-hooks vary in length from 2½ to 6 feet, 3½ feet being best for average use. They vary also in the shape of the point on the hook, the best-known patterns being the *duck bill*, *round*, *diamond*, and *chisel*, of which the duck bill is the most widely used, and unless otherwise specified, your cant-hook or peavey will probably come in that pattern.

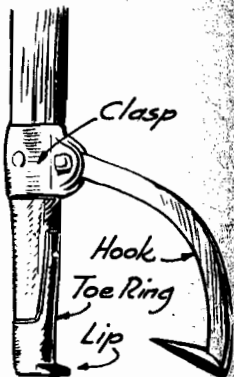

CANT-HOOK

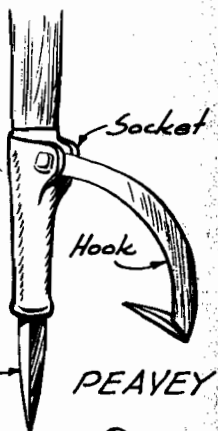

PEAVEY

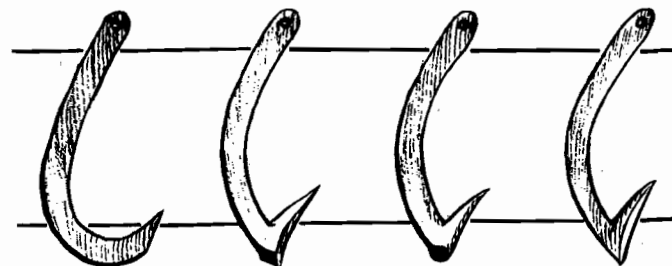
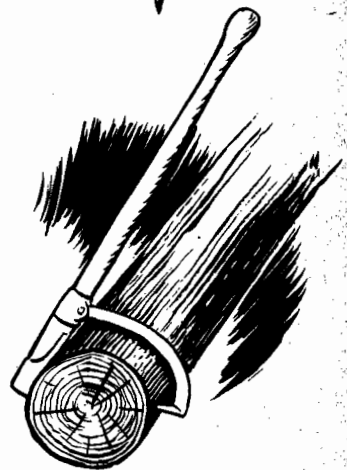

CHISEL DIAMOND ROUND DUCK BILL

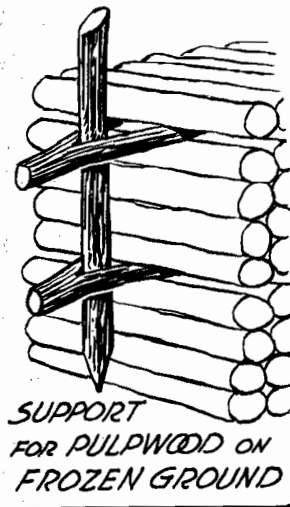
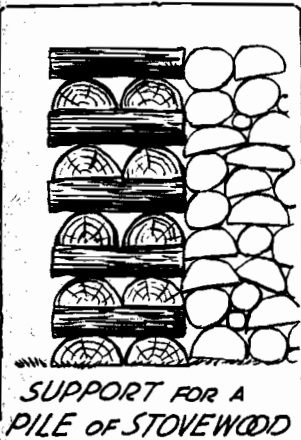
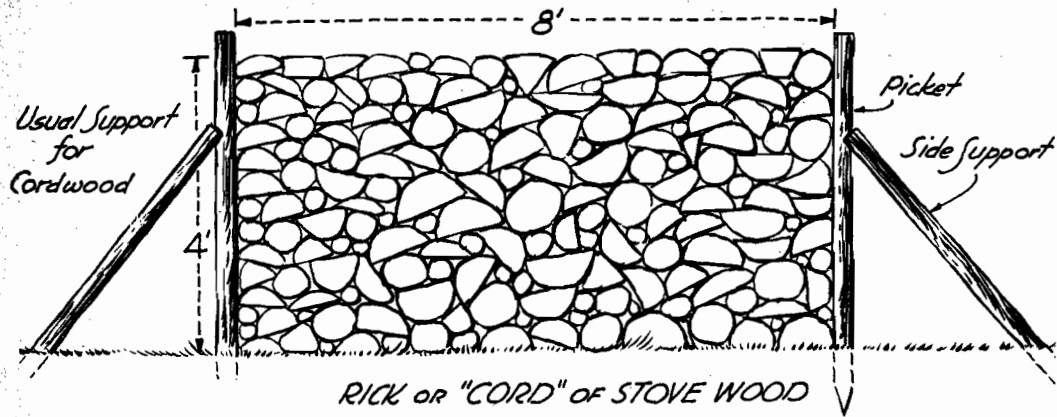

### CORDING

A CORD IS A UNIT OF MEASURE FOR WOOD, in the same way that a gallon is for gasoline, or a bushel for potatoes. A *cord* is a pile of wood 8 feet long, 4 feet high, and 4 feet wide. A *rick*, on the other hand, is a pile 8 feet long, 4 feet high, and of whatever width the wood happens to be cut. Stovewood, for example, is usually cut 16 inches long, and a pile of it 8 feet long and 4 feet high, would be a rick. To be a cord this wood would have to be piled three pieces end to end, so as to make the pile 4 feet wide.

Pulpwood logs are usually cut into 4-foot bolts, and so a pile of these 8 feet long and 4 feet wide would be a cord. In some sections pulpwood is cut 8 feet long, in which case a pile 4 feet long and 4 feet high would be a cord. In other words, a cord is 128 cubic feet.

In popular usage, however, the word *cord* is often used to mean a rick. Thus a pile of short stovewood 8 feet long and 4 feet high is often referred to as a cord of this wood. Although incorrect, this use of the word is quite widespread, and in some sections of the country the word *rick* does not seem to be used at all.

Wood should always be piled 4 feet high, so that by measuring the length of the pile one can tell how many ricks or cords there are in it. This is the most convenient height anyway.

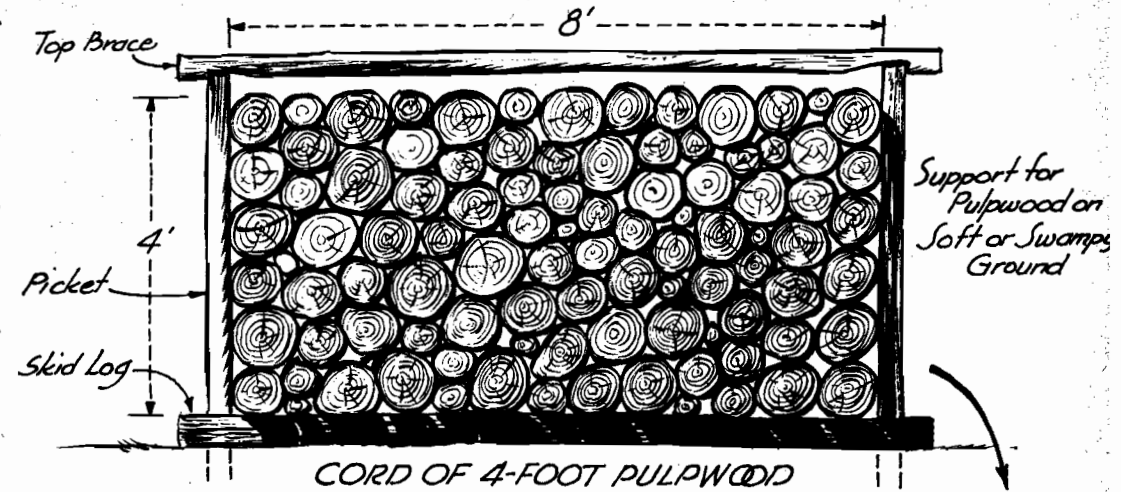

The easiest way to stack stovewood is to crisscross the end pieces, thus making a solid support to hold the pile secure. For longer wood, such as the 4-foot pulpwood, the usual method is to drive a *picket* in the ground at each end of the pile, supported by a pole propped against it. If the ground is soft or swampy, a brace is put across the top instead, notched to accommodate the tops of the pickets.

Long logs, if few in number, may be *bunched* in low piles, onto which they can easily be swung. If many, they may be either rolled up onto the pile on *piling skids*, or swung up on a *piling jack*. This jack is made from a 6-inch pole, notched with ladder steps about 18 inches apart. By leaning it against the pile  $\frac{1}{3}$  from the end, the log can be placed in one of the notches and swung up.

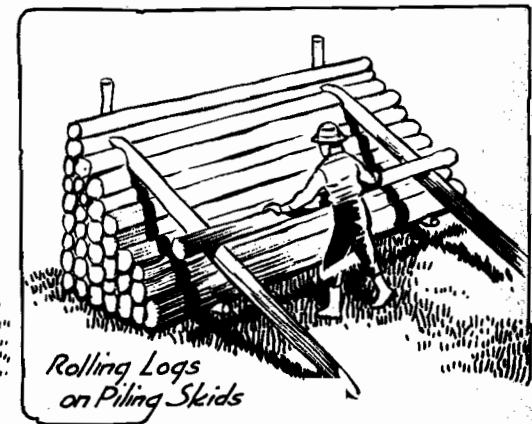
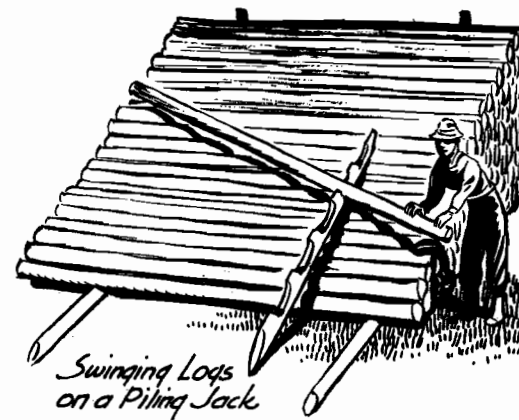
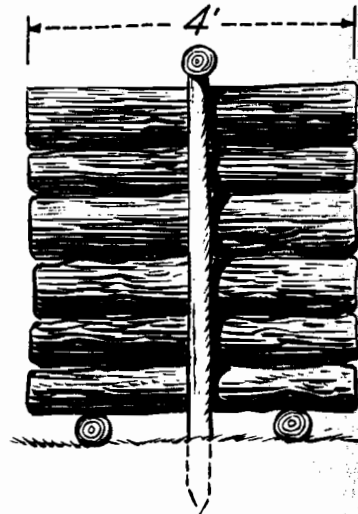

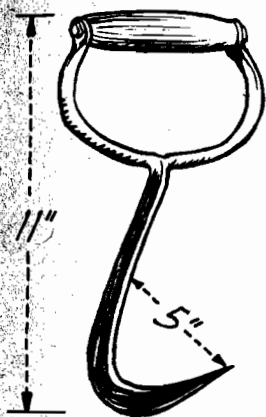

## THE HANDY PULPHOOK

WE SEE IT IN THE PICTURE—a small steel hook that serves as an extension of the arm in reaching out after logs. It is just about the handiest gadget ever invented for working around small logs, and to the pulpwood logger, working in small timber as he does, it is almost as important as ax and saw—hence the name, pulphook.

A glance at the pictures will indicate its many uses—for picking up logs, for swinging them around, and for snaking them to you; for carrying short bolts, and for throwing them to the pile. It's a snap to toss a log with a hook, but difficult to heave the unwieldy thing very far by hand—the hook gets more distance and greatly improves your aim. The woodsman who adds a pulphook to his outfit saves himself much stooping, lifting, reaching, handling, and wear and tear on the human frame.

A hook with a blunt point grips the log better, and is safer. File the point off flat to a thickness of about  $\frac{1}{16}$  inch.

A pulphook is to be respected, for it is dangerous if thrown about carelessly. Hang it up when not in use. And beware of jabbing it into the side of a log, for it is apt to glance off and stab your leg—it bites into the end of a log but shies off the side.

An ax is sometimes used to do the work of a pulphook, but it is exceedingly dangerous practice, and has caused many and many an accident. *An ax should never be used for lifting, snaking, or throwing.*

Pulphooks can be made by any blacksmith, indeed are so made in the logging camps. They are not on the market.

One of the most thrilling of roleo events is the log-throwing contest with a pulphook (see page 81).

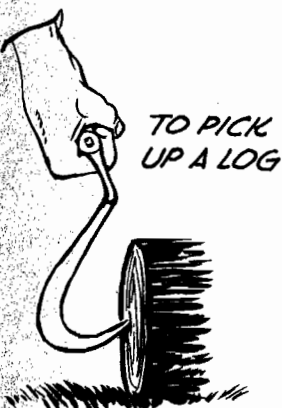

## CARRYING LOGS

IT'S REALLY A JOB for a team of horses or a tractor, but if necessary a log can be hauled out by hand—and without any tools, if need be, although the *come-alongs* and *skid ropes* described in the following chapters would be a great help.

*Toothpicks* or slender poles can often be dragged out by hooking your arm around one end and walking forward. If too heavy, they may be moved by *swinging* them end for end, that is, by picking up one end and swinging it forward and dropping it, then picking up the other end and swinging it forward. To do this, however, the log must be in the clear.

Big logs up to backbreakers (over 14 inches) in size can be carried on skid-poles placed crosswise underneath as in the drawing. Several men then pick up the log by means of the skid-poles. *But watch your footing*, for if a man should stumble and fall there is grave danger that the heavy log will be thrown upon him. For this reason it is never wise for four men to carry a log, because if one falls the log is almost sure to hit him; with six, there is hope that it will be held up by the remaining two men on that side. The front men who can see the trail ahead should warn of every root and boghole underfoot, and of every *widow-maker* overhead, in the latter case calling "Headache," which is the lumberjacks' warning that an overhanging branch is at head bumping level and must be ducked.

If the ground is level enough, the log may be rolled on the skid poles instead of carried. Place the skid poles crosswise and push the log forward, bringing the back pole forward whenever the log rolls off it.

In lifting a log, never bend down and hoist it by straightening up, for this places undue strain on the muscles of the back, and often causes back injury and hernia. Squat down and lift it with the leg muscles.

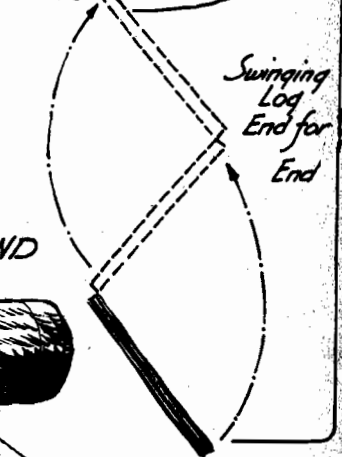

## SKID LOGS UNDERNEATH FOR CARRYING BY HAND

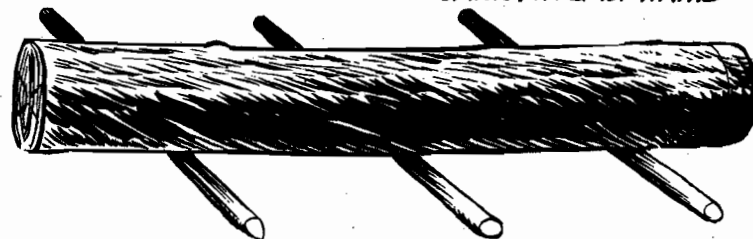



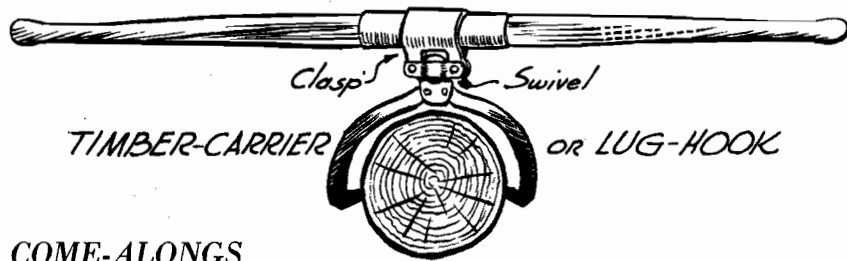

### COME-ALONGS

THEY ARE VARIOUSLY CALLED *come-alongs*, *lug-hooks*, or *timber-carriers*, and for moving a log, they have anything beat short of a team of horses to skid it. These ingenious devices for carrying a log by hand consist of a pair of dogs or hooks set opposite each other like ice-tongs, and hung in the middle of a long handle, so that when the hooks are clamped on a log there is a convenient handle on each side by which to lift it.

There is nothing like having the right tools with which to work. Handling a log with a pair of come-alongs is so much quicker, safer and more convenient than carrying it on skid poles. The hooks can be applied in a jiffy, and when the log is lifted it is carried *low*, just off the ground, so that if a man should trip and fall there is no danger of the log falling on him, whereas with skid-poles it is held high and offers grave danger in case of a fall. There is just one thing to watch: when the hooks are clamped on make sure they are firmly set.

With a lug-hook clamped on the front end, two men can swing a log around and even drag it a short distance, although dragging is heavy work. A pair of hooks, one at each end, will be necessary to transport it, perhaps more, depending on its size.

The hooks are equipped with a swivel so that the handle can turn, which is a great convenience in going through a narrow opening, as for example between two trees so close together that the ends of the handle would hit if it did not turn.

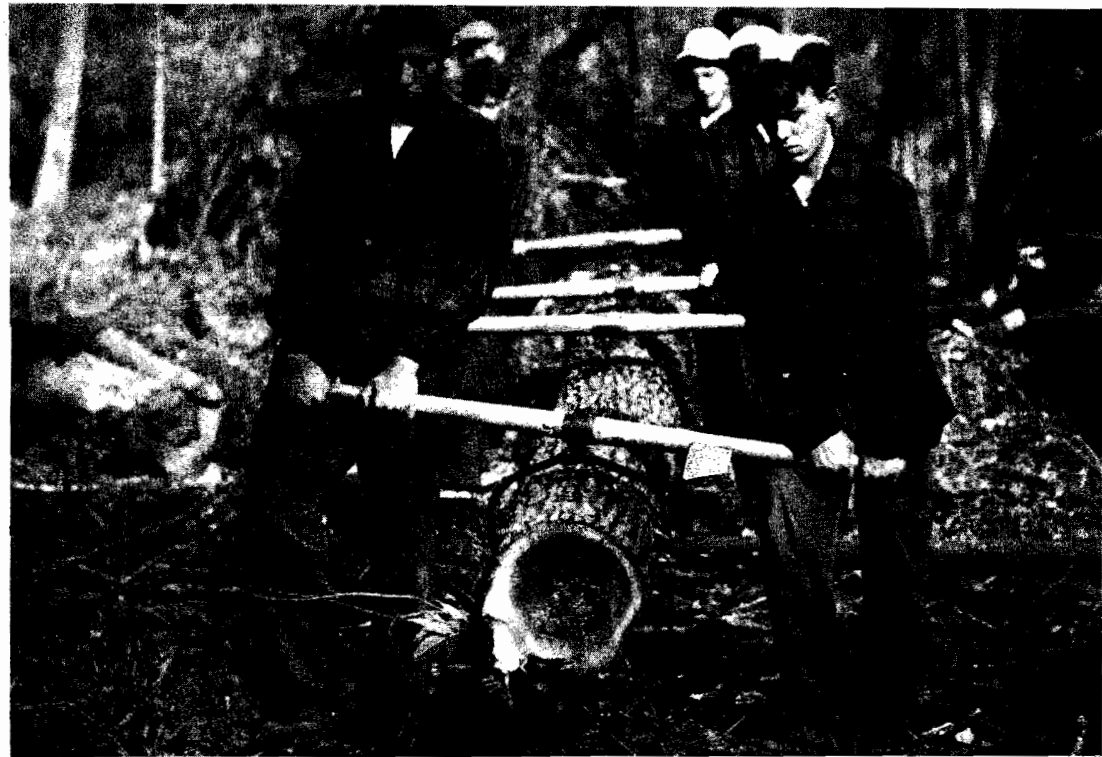
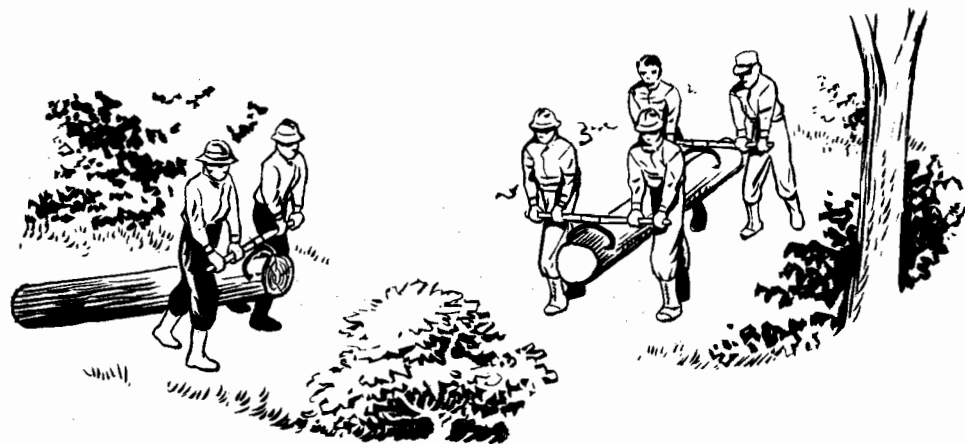

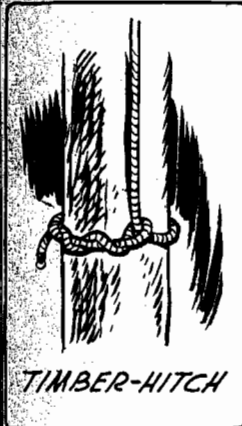

TIMBER-HITCH

## SKIDDING

IN THE LOGGING CAMPS it would be done with a skid-chain and a caterpillar or a team of horses, but this is not a book on how the big outfits operate. Rather it is a book on how you and I can get the job done with whatever happens to be at hand. If a rope is handy, three or four men can skid out a pretty big log on level ground, and it is a lot easier than carrying it. If a team is available to pull it, so much the better, and the arrangement of the rope would be the same.

It is done with a *timber-hitch* tied as in the drawing, which knot is famed for its ability to grip even a slippery spar. The timber-hitch should be applied near the back end of the log, and a simple hitch added at the front end, the purpose of which is to guide the log as it is being snaked along the ground.

Rough ground will hamper any skidding operations, but on smooth ground the log will come right along. Indeed, as a race for speed, skidding is one of the most thrilling events for young men in a logger's roleo, as described on page 81.

There is danger in snaking, however, not to those who are in front and pulling, but to anyone walking *beside* the log, for logs have a vicious way of jumping sidewise when they hit a bump. Many a logger's leg has been broken in this way. Always walk *behind* the log. In skidding with a team the driver is often forced to walk beside the log, but he should remember he is taking a grave risk and be cautious.

A log will skid more easily if it is *nosed*, that is, if the edges at the front end are rounded off.

The easiest way to get a log up a steep hill by hand is to par-buckle it. The arrangement is shown in the drawing—hang the rope at its middle around a tree at the top of the hill, then put the ends around the log so that the log rests in the loops. By pulling on the ends the log will come up with surprising ease.

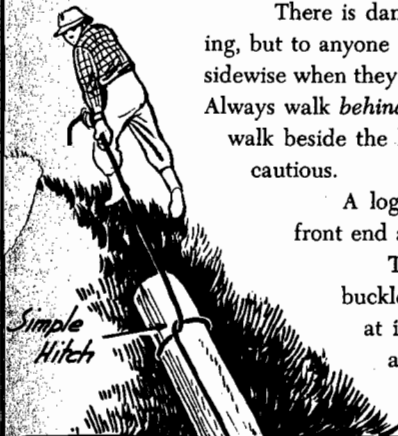
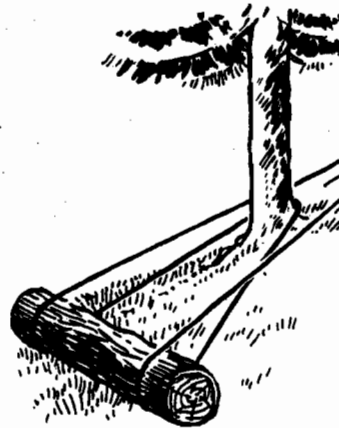

Simple Hitch

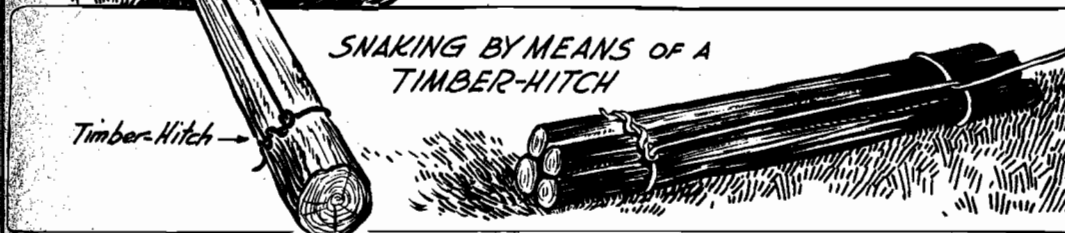

SKIDDING BY MEANS OF A  
TIMBER-HITCH

Timber-Hitch

## PIKE-POLES

THE EASIEST WAY TO MOVE LOGS is to float them. The long way round by water is often preferred to the short way by land.

If there is a current the logs will take care of themselves and travel on their own, with just a little shove now and then to keep them headed right. Here is where the *pike-pole* comes in, the long arm with which the river-jockey reaches far out over the water to push and to pull the strays into line. For pike-poles are long and slender, ranging from 10 to 20 feet, and are exceedingly light. A pike-pole is just what the name implies—a pike (spike) on the end of a pole. Most of them have a hook in addition, the hook for pulling, and the pike for pushing. The three styles are shown at the top of the page, the commonest being the curved pike and hook.

If the stray log cannot be reached from shore, the jockey leaps out on the floating logs, and jumping from one to another, goes right out to it. In this business of riding the logs, the pike-pole serves another purpose—it is a sort of balancing pole, helping the rider to keep his balance, especially while birling or spinning the logs, as described in the next chapter.

In floating logs in a lake, without benefit of current, a *boom* is formed by chaining a number of logs end to end to form a large circle which surrounds the mass of logs and holds them together. The boom is then towed by a pull boat. When the river is reached the boom is broken and the logs turned to float.

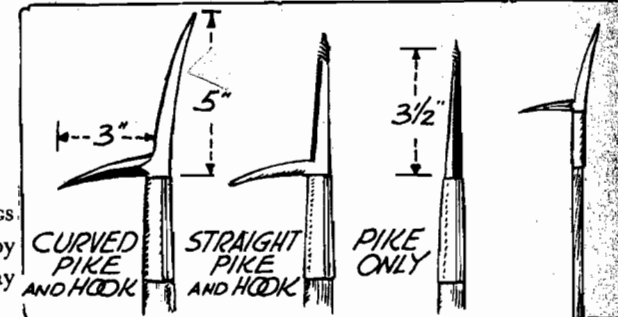

CURVED  
PIKE  
AND HOOK

STRAIGHT  
PIKE  
AND HOOK

PIKE  
ONLY

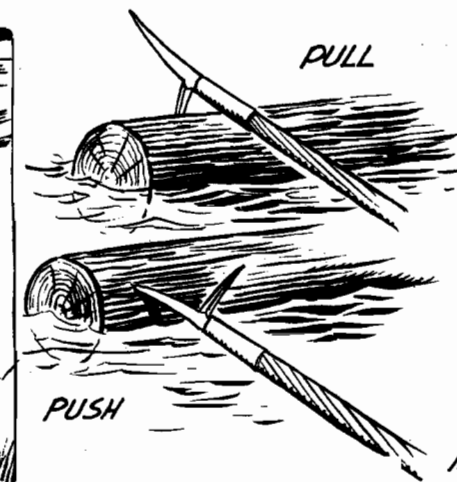
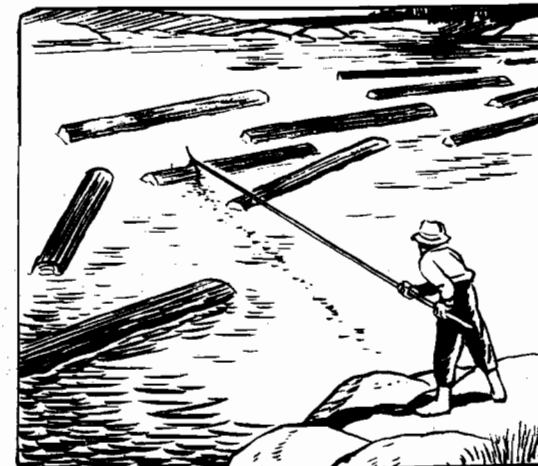

PULL

PUSH

PIKE-  
POLE  
10 to 20  
long



## BIRLING

BIRLING MAY BE PART OF THE WORK-A-DAY LIFE of the log-jockey on the rivers, but it is also one of his chief sports at the roleo, related to it as the bronc riding is to the cowboy's rodeo.

While one can have fun on a log barefooted or with tennis shoes, he can't go far without calks, the short spikes driven in the soles of heavy leather shoes. Size 000 is used except on Douglas fir of the Pacific Coast, where size 00 is preferred.

The best birling logs are of cork white pine, but any straight smooth soft-wood log will do, 20 inches in diameter, from 12 to 16 feet long. Bark it and smooth it up. A balancing pole is also needed, made from a 14-foot cedar sapling, 2 inches thick.

Start by just standing on the log until you feel at home. If balance is difficult, use the pole with about one foot of the far end in the water. There are two fundamentals of birling—to *roll* the log, and to *snub* or stop it.

To *roll it*, face sideways, crouch a little, and start treading slowly. As the log turns it will tend to take you down the back side of it into the water. Watch these things: (1) *Spin it slowly*—speed can come later. (2) Keep your eyes on the *end* of the log. (3) Stay on *top* the log, always using short quick steps. (4) Maintain a slight crouch, your knees slightly bent. (5) If you start going, *fight to get back*.

To *snub it*, jump up and bring your feet down together on the front or up-coming side, jamming your calks in. Or, jump up, do an about-face in the air, land on the log facing the other way, and start treading.

Most fun is when two men try to roll each other off. Then the secret is, never take your eyes off the other fellow's feet.

STANDING

ROLLING

SNUBBING



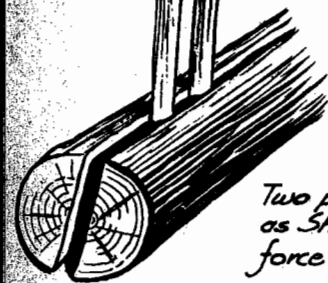
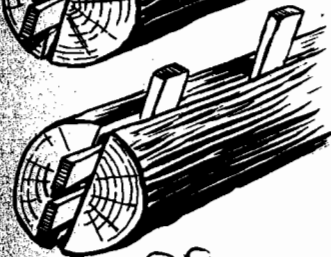
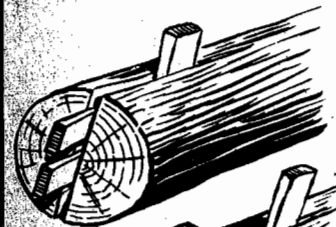
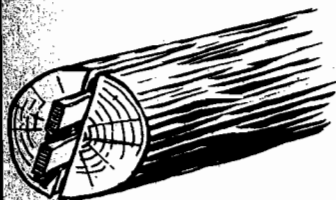
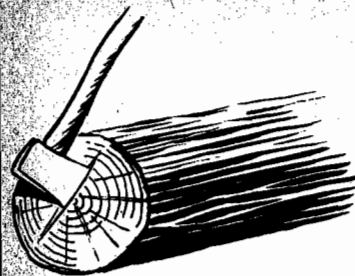

Two poles used as Shears to force the split open

### SPLITTING LOGS

EXAMINE THE END OF A LOG that has been sawed square: note the rays or lines radiating from the center out to the edges. These are the natural lines of cleavage. There may even be an actual crack or *check*, and if so that is the place to split it.

Begin at the small end of the log, for it will split easier that way. Place the ax on the end and tap it gently to start a split wide enough to receive the wedges. Then place two wedges in this split, and drive them in until a crack appears on the side of the log. Drive a third wedge in this side crack, thus extending the split up the side. Then drive a fourth wedge in farther along. Now go back and drive the third in deeper. By now the crack should be spread enough to release the two end wedges, which can be removed and used to continue the split throughout the length of the log.

A free-splitting log will usually separate at this stage without further encouragement, but occasionally heavy splinters will extend from one side of the split to the other to hold it together. These can sometimes be cut with a small ax, but if stubborn, two poles should be forced into the split side by side to form the *shears* shown in the drawing. By shoving one pole in one direction, and the other in the other direction, the two halves can be forced apart.

In starting a wedge, do not hit it a hard blow at first, for it may fly out dangerously. Tap it gently until firmly set.

A small log can sometimes be split by using two axes, as in the drawing. The second ax frees the first, and it is then driven in farther along.

Not every log is a splitting log. It must be sound and straight-grained, and sometimes there is no way to tell without trying it.



### WEDGES AND GLUTS

IT IS THE FUNCTION OF WEDGES to spread timber apart and force it open. They fill three major roles: first in *splitting*, where they are driven into the log to start the split and force it open; second, in *bucking*, where they are driven into the kerf to prevent pinching; and third, in *felling trees*, where they are forced into the kerf to throw the tree in the desired direction and hasten the fall.

Special wedges are made for each of these uses, as seen in the drawings, but the common splitting wedge, although heavy to carry, will do for all of them.

Beyond question the best wedge for felling and bucking is the *Michigan wooded type*, recently developed in the logging camps of upper Michigan. In its hollow center a piece of hardwood is inserted, not only making it exceedingly light to carry, but *permitting it to be driven with an ax*, a great advantage, for when the all-steel wedges are used a maul must be carried along for driving. The local blacksmiths make this wedge.

*Wooden gluts* will serve any purpose for which wedges are used, and are often used in connection with steel wedges when the latter are not large enough. They can be made on the spot when needed. The best woods are *ironwood*, *apple*, *locust* and *dogwood*, usable even when green, but any hardwood will do. Make them from a limb of the right thickness, at least a foot long (the commonest mistake is to make them too short), and taper evenly on both sides. Green wedges can be hardened in Indian fashion by heating them over the fire to dry them, being cautious not to char them.

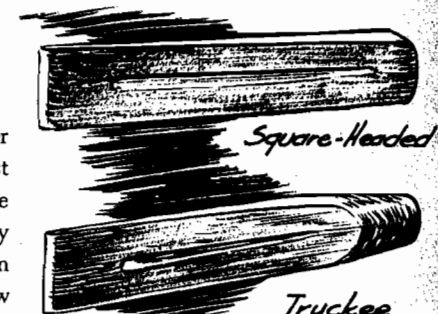

SPLITTING WEDGES

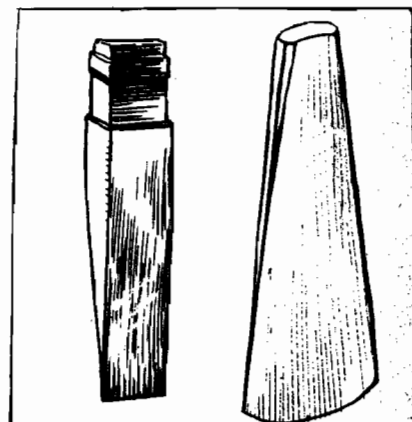

Michigan Wooded Standard FELLING WEDGES



Carry your wedge in a belt sheath

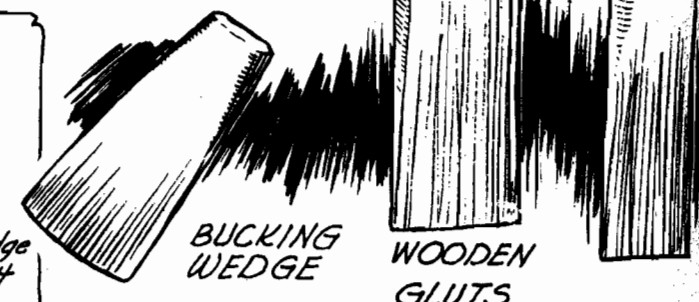

BUCKING WEDGE WOODEN GLUTS

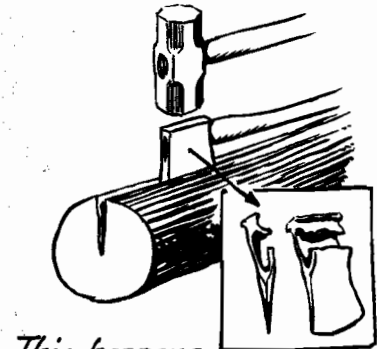
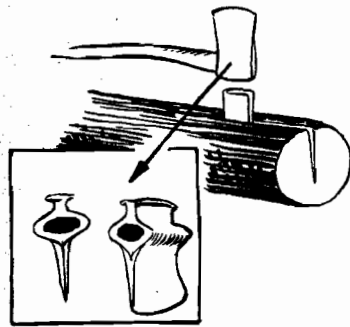

*This happens when ax is used as a maul or a wedge!*

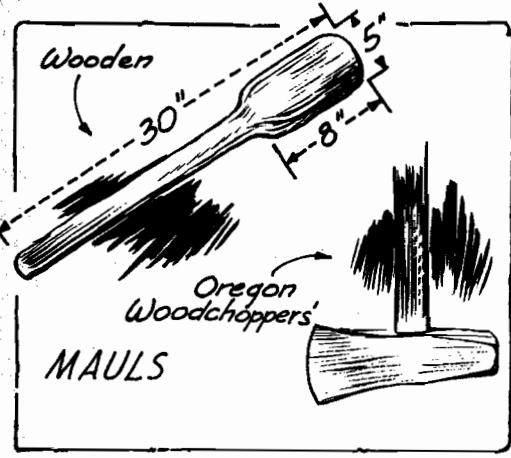

### TO DRIVE WEDGES

THE FIRST RULE IS, never drive a steel wedge with an ax. And the second rule is never drive an ax with another ax, or with a sledge. To subject an ax to such treatment will ruin it sooner or later, as the pictures clearly show. An ax is a chopping tool, and should be used for that, and that alone. It is not made for use as a wedge, or as a sledge, or as a maul. And no one who respects his ax as a woodsman should will abuse it in these ways.

Make a wooden maul with which to drive the wedges. This is a club-shaped tool, big at one end, as shown in the picture. Ironwood is best—hickory, beech, oak are excellent—but any hardwood will do. Find a sapling 5 to 6 inches through at the butt and cut it off right at the level of the ground or a little below, for the wood is toughest there. This butt end is to be the big end of the maul. Leave it full width for 8 inches, then shave down the remainder for the handle, making it 30 inches overall.

For steady use, a steel maul is preferable, because the wooden ones get battered up so quickly. While a blacksmith's sledge might do, the proper tool is the woodchopper's maul, a combination of maul and wedge, made for this purpose. The Oregon style is most widely used. These mauls are standard items at hardware stores, coming in weights from 6 to 10 pounds.

A maul of some type, either wooden or iron, should always be handy, kept with the wedges. Without it there is too much temptation to use the ax. The only steel wedge that can be driven with an ax is the Michigan wooded type (page 51).

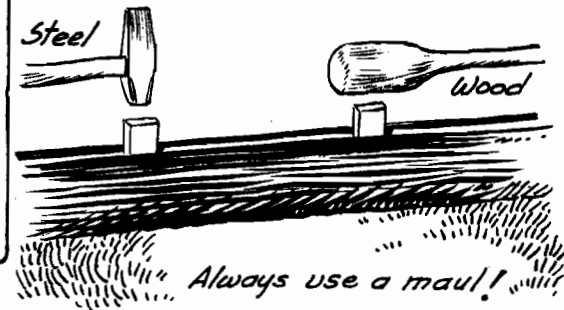

### AS THIN AS A RAIL

HERE IS SOLID JOY. Just why is hard to say, but there is something deeply satisfying in splitting timber into rails, in seeing the crack open straight and true, and hearing the wood split asunder. And contrary to the popular impression, it is not particularly laborious, nor difficult for inexperienced hands to do.

There is no satisfaction, however, in attempting to split rails from a tough, crooked, or otherwise ornery log. A rail log must not only split easily, but must be resistant to decay, for rails must last for many years. Best is white cedar for it is light to handle, splits freely and is most durable. Often used also are chestnut, white pine, white oaks and sassafras. If durability is not important, any splitting log will do. There is no sure way to tell whether a log will split without trying it, but you can at least pick one that is straight-grained and free from knots.

First, split it in half (A), then split each half again (B). What to do from now on depends on the size of the log and the number of rails that can be gotten out of it. After the log is quartered, you just have to look and decide. If it is a small log of about a foot in diameter, split the quarters once more, into eighths, which should be the right size for rails as they stand. If a little larger, it might be better to split the quarters into three. If it is a large log around 18 inches in diameter, the eighths are first reduced by splitting off a rail from the point of the triangle as shown in C, then splitting the remaining piece in two as in D. If the splits tend to run out, making one part thinner than the other, a second wedge should be driven in the other end.

The standard length of rails for fences is 11 feet. There is no set rule for thickness, and needless to say it will vary considerably, but four inches can be used as a guide.

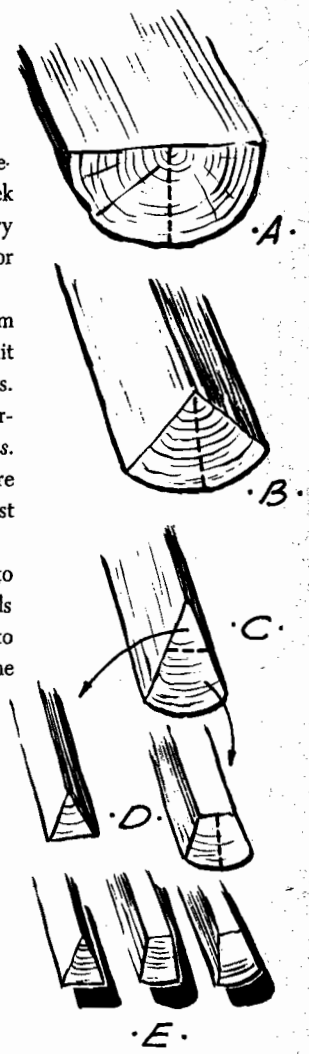

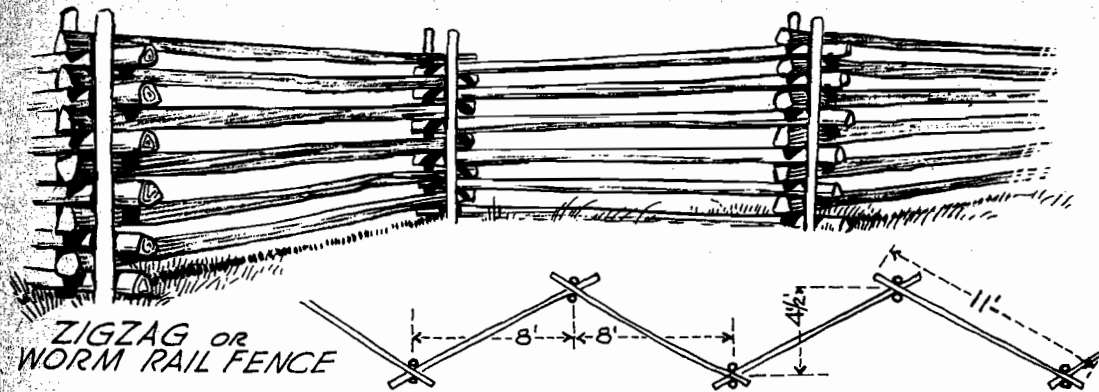

ZIGZAG OR WORM RAIL FENCE

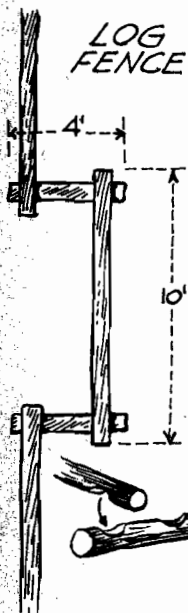

LOG FENCE

**HORSE-HIGH, BULL-STRONG, AND PIG-TIGHT**

THOSE RAILS WE SPLIT in the last chapter will meet well this backwoods definition of a good fence—high enough to discourage any horse, strong enough to control any bull, and tight enough to keep any pig from worming through!

The zigzag type of rail fence, popular since earliest pioneer days, is commonly made six rails high, which is considered to be "horse-high" in most parts (4 to 4 1/2 feet). The rails should be 11 feet long, so placed as to give the fence a width of 4 1/2 feet as in the diagram. The largest rails are always placed on top so as not to be blown off. When the rails are in place the fence will be found sturdy enough to meet most conditions as it stands, but to make it bull-strong two stakes should be driven in the ground at each intersection as shown.

Popular also is the rail-and-stake fence, which has the advantage of making the rails go farther because it is straight. The stakes are driven in the ground, and wired at top and bottom.

More decorative is the mortised fence, which can be made either with split rails or round poles. It is usually four rails high.

The log fence is made of round poles notched in log-cabin fashion, and spiked. It makes a very strong fence.

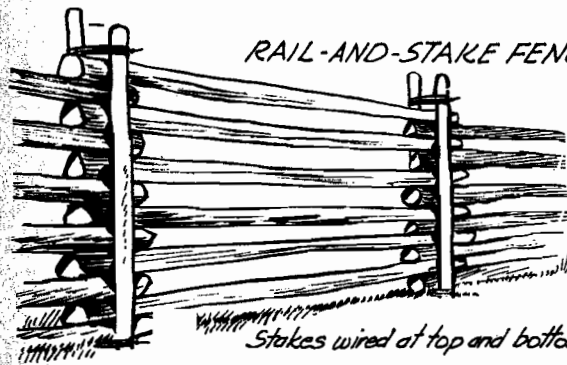

RAIL-AND-STAKE FENCE

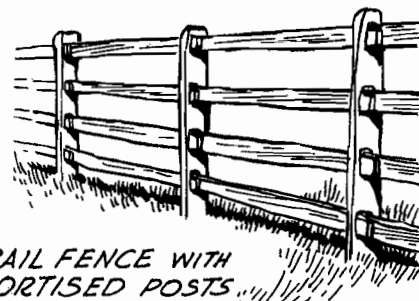

RAIL FENCE WITH MORTISED POSTS

Stakes wired at top and bottom

**BETLES**

THEY ARE BIG MALLETS for driving posts and large stakes in the ground. A sledge would batter the tops of the posts and surely ruin them—only the beetle will do. It is no problem to make one, although the help of a blacksmith will be needed to put on the iron bands. Use ironwood if possible, even if you have to hunt far for it, otherwise some tough hardwood to withstand the severe battering it will receive. Hunt for a tree measuring seven inches at the butt, and cut it off just at ground level, using the butt for the beetle head because the wood is toughest there. Shape it to the dimensions shown, shaving the ends down carefully, and then have a blacksmith shrink the iron bands on the ends. The three-foot handle should be of ironwood or elm, and firmly wedged.

Posts as large as fenceposts can usually be driven with the beetle, unless the ground is very hard or rocky. It is much easier than digging postholes, believe me.

It is pretty hard to miss the post with the big beetles, but to play safe, have your partner hold it with a bent green branch as in the drawing.

The chief requirement for a post is that it withstand decay. The best woods are white cedar, red cedar, black locust, chestnut, and osage orange, these lasting from 15 to 30 years. Good, also, are tamarack, cypress, hemlock, white oak, and black walnut, which have a life span up to 15 years.

If the bottom end of the post is dipped in a bucket of creosote, its life will be greatly increased. Or, in the way of the backwoods, the ends can be charred in the campfire to prevent decay.

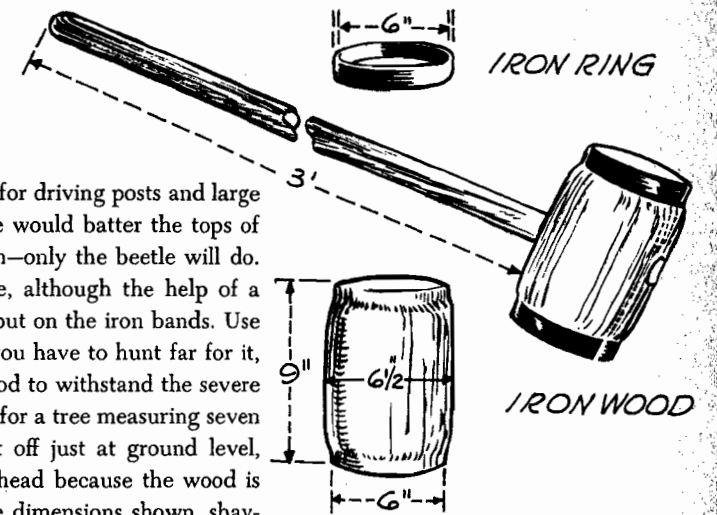

IRON RING

IRON WOOD

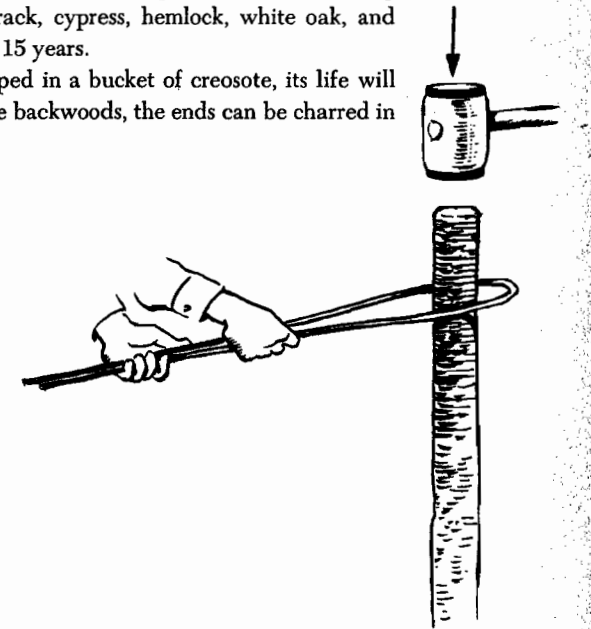

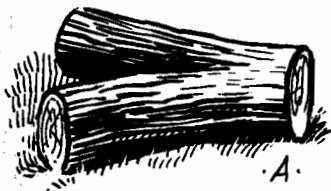

## CHOPPING BLOCKS

WE WOULD SPEAK MORE ACCURATELY to call them *splitting* blocks, since they are used in splitting stovewood, but they have always been known as chopping blocks so that seems to settle it. In chopping, one cuts crosswise of the grain, as in chopping a log in two, whereas in splitting one cuts with the grain, as in splitting a chunk lengthwise. The man at the woodpile who swings his ax at the end of a chunk to cut it in half is therefore not chopping wood, as the common expression has it, but splitting wood.

Best of all chopping blocks is the Y-shaped arrangement shown in the drawing, best because it holds the chunk of wood upright and steady, even if its end is not sawed square.

Hunt around until you find the just-right fork of solid, tough hardwood, such as sycamore, elm, sugar maple or oak. The branches of the crotch should be six inches in diameter; less than that they will do little good. Trimmed as in A, the block can be used as is, although it would be handier if the top were flattened as in D to provide a flat surface for cutting small stuff. To do this, cut a series of notches as in C, then chop off the sections between. Sometimes a chopping block is seen with a slab of wood nailed across the end as in D, but this offers few, if any, advantages.

A section of a large log split in half may be imbedded in the ground under the chopping block, flat side up, so as to prevent the ax from striking the ground, but a good axman will not find this necessary.

If one only has a little wood to split now and then, he can improvise a block by laying one half of a round chunk on the ground, flat side down, as seen on the opposite page. But for a permanent woodpile, a permanent chopping block is well worth the effort to make in the safety and convenience it affords.

Near the chopping block also should be a kindling block, made from a stump-shaped section of log stood on end, a great convenience in that it brings the work up to a handy height.

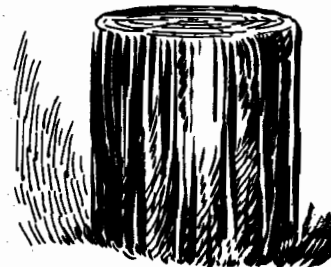
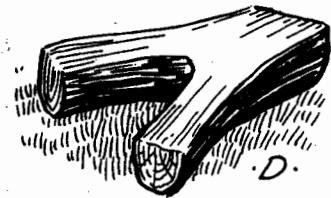
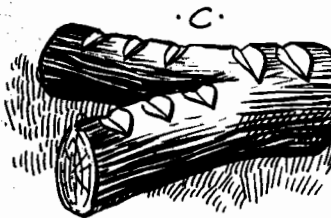
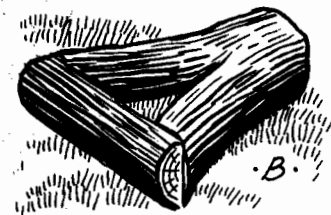

KINDLING BLOCK

## SPLITTING STOVEWOOD

SET THE ROUND CHUNK ON END in the chopping block (A), lift the ax over the right shoulder and bring it down with a natural swing, sliding the right hand down the handle just as in chopping logs (page 18). Just as it hits, give it a slight twist, throwing the butt or pole of the ax to the right—Figure F shows the ax just as it is hitting, and G after the twist has been made. The secret of splitting rests right here in this little twist: It spreads the split, acting as fulcrum on one side and forcing the other side away, thus throwing the two halves apart. It prevents the ax from freezing should the chunk refuse to split, and it prevents the ax from going through into the ground should the chunk split readily.

When split in half, place one of the halves in the block as in B, or if it will not rest solidly, lean it against one side as in C. When leaned in this way, always work from the *far side*, never on the near side with your foot against it. That is so dangerous that no one but a dub would do it. It is just inviting a cut foot.

Round chunks that will not stand on end should be leaned in the crotch, or in a notch chopped in a log.

A tough, knotty, ornery chunk can usually be split by cutting off slabs from the sides to reduce it. If not, use a wedge.

Never stand a chunk beside a large log and attempt to split it as in J, for if the ax handle should hit the log it is apt to break, or at least to jar your hands painfully.

If the ax freezes in a chunk, do not try to wrestle it free, but strike the end of the handle a sharp blow from underneath with the heel of your hand.

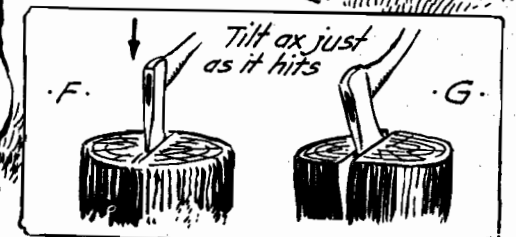
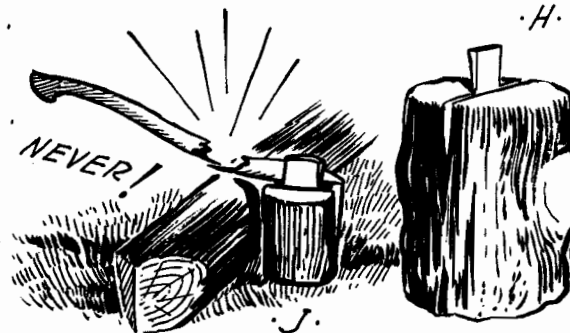
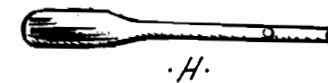
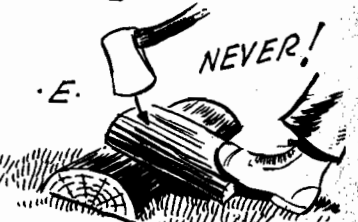
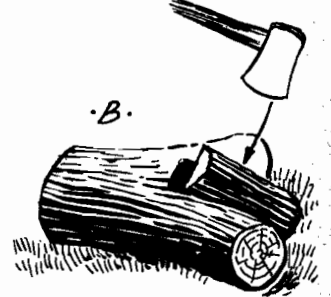
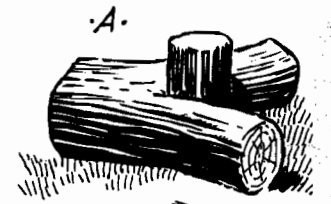

## GETTING THE SHAKES

*Shakes, clapboards, splits*, as you may choose to call them—they are thin boards split from a log and used in place of shingles on a roof. The art of splitting them is well-nigh a lost one, except among a few old-timers of the back country who remember a long yesterday of simple living. Yet it is an easy skill to learn, and a grand one to know, full of the glamour of pioneer days, smacking of true woodsmanship. A useful one too, for shakes still make the most picturesque roof for a cabin or shack, and are as dependable as any that can be had.

A *froe* is needed, which can be made by any blacksmith from the picture. The blade should be 12 to 14 inches long, bluntly sharpened for it is used more as a wedge than as a knife. A small hand maul 15 inches long is also needed.

Much depends upon finding the just-right tree. *Northern white cedar* is best, noted for the ease for which it splits, and the remarkable durability of the shakes made of it. Good, also, are the *oaks*, the *pin*es both white and yellow, and *tulip*. But not all trees of these varieties will do. Look for a big tree, the bigger the better—the ideal size is two feet in diameter but nowadays we may have to accept a smaller one. Above all, it must be straight-grained: look for one that stands straight and symmetrical, that is free from knots, and that has *straight bark*, the furrows of which go straight up the tree—crooked bark usually indicates crooked grain. If the tree meets these requirements, it should be worth trying.

Clapboards are 30 to 36 inches in length. Saw off a 36-inch section, stand it on end, and split it in half very carefully, first tapping your ax gently to make a groove entirely across it, then driving it in to split it. Now split the halves again in the same way, then split the quarters once more. The log is now split into eight sections, and each of these should be split once

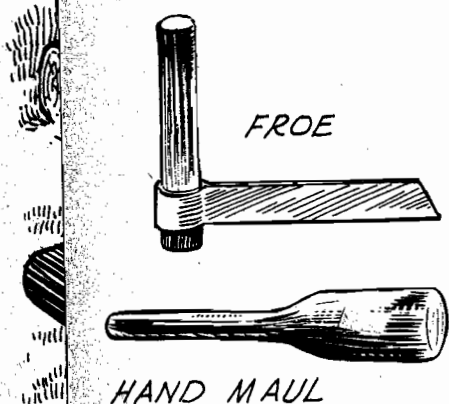

FROE

HAND MAUL

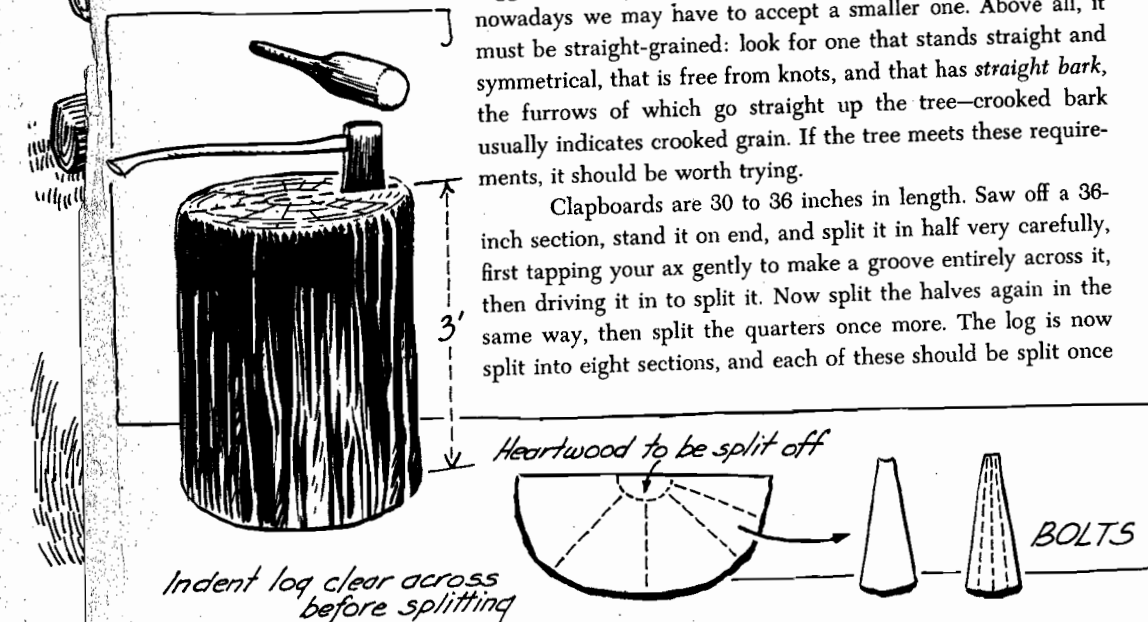

more. The bolts we now have should each make four or more clapboards.

The heartwood at the log's center must now be split off from each bolt by placing the ax crosswise of it and driving it with the maul.

Now rig up a supporting rack to hold the bolts while working on them, as shown in the drawing. Note that the bottom of the bolt rests against a brake, such as a stump or another log. This brake should not only prevent the bottom from sliding on the ground, but should be so constructed as to prevent it from slipping upward when one presses down on the other end.

Stand the bolt in position, take the froe in the left hand and maul in the right. Place the froe across the exact middle of the bolt, along one of the rays of the wood, and tap it gently until imbedded. Then lay the maul down, grip the bolt with the right hand, and work the handle of the froe with the left so as to *spring* the wood apart. Split each of these halves again in the same way, and continue thus until the bolt is reduced to thin clapboards.

Difficulty is encountered when the split tends to run out to one side, rather than going straight. When it starts to run out, lay the bolt on the supporting log with the thicker side down, slip your hand in the split above the froe, palm down, and press down hard with it, thus forcing the thick side down onto the supporting log. Now work the froe handle up and down, which action should cause the split to run back into the thick section again. If a bolt tends to run out when split from one end, turn it upside down and work from the other end.

It was Horace Kephart who first described this method of the backwoodsmen for straightening a crooked split, and as he has pointed out, it is right here in this process that the real skill of the shake splitter rests. For anyone can split a straight-splitting bolt, once he has caught on to the tricks of the froe. Only experience, using the method described, will develop the know-how to make good with the tough ones.

Clapboards are, of course, thicker on one side than on the other, and will vary somewhat in thickness, but this will make no difference so long as they are fairly uniform.

SUPPORTING RACK

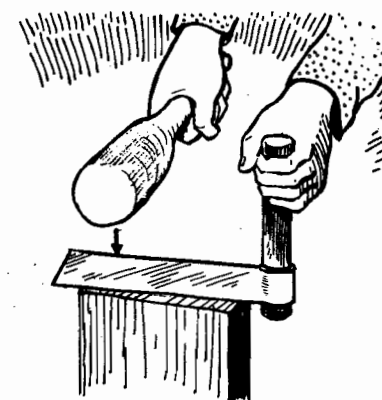
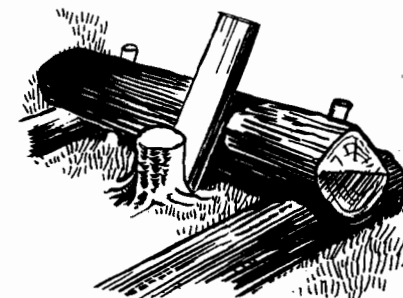



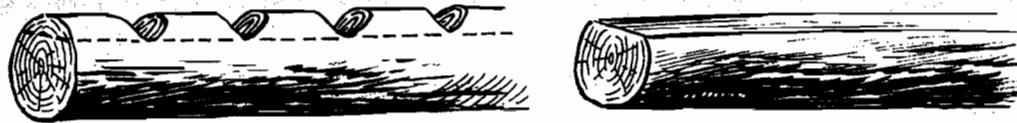

## HEW TO THE LINE

THE SHAPING OF LOGS WITH AX OR ADZ IS the art of hewing. One will not live long in the woods without the need for hewing, even if only to flatten a log for a bench or seat. Who has not looked with admiration upon the logs of some ancient cabin, square-hewn by the woodsmen of another day? Or upon hand-hewn beams on which the marks of ax and adz still lend their charm?

The ax with which the professional does this job is the *broadax*. A mighty weapon this, weighing 7 to 7½ pounds, with a blade a full foot wide, bevelled on one side only. It is a tool only for the expert, needed only where hewing is a business. Any good ax will do the job.

First, remove the bark, and then mark a line along the side of the log to guide the ax. Do this very carefully with a chalk-line, stretched very tightly between two nails at the ends, taking pains to smooth out all rough spots on the log so that the line lies flat and even. Chalk the line heavily, or if necessary blacken it with charcoal, and snap it. Make a similar line on the other side, and then strengthen the lines with a lumberman's crayon. This is what is meant by "hewing to a line."

Now chop a series of notches along the top of the log, or if skillful enough with the ax, merely gash it, as in the drawings. Or if you prefer, saw it instead. Care should be taken to extend the cuts as near to the line as possible but never beyond it.

Now elevate the log on sawbucks. Knock out the wood between the notches, and then, working very carefully, shave it down flat to the line. Keep your ax very sharp, hold it short, and take short careful strokes. Keep your eye on the line, turning the log occasionally and working from the other side. If you work this way you can, with care, produce as smooth a surface as if it had been sawed.

Another method of hewing is with an adz, described on page 61.

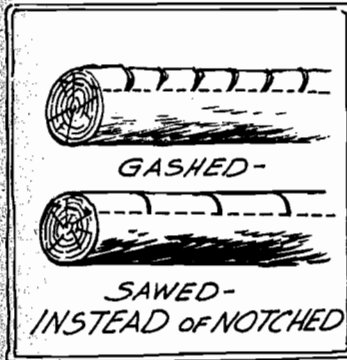

BROADAX

## WITH THE AID OF AN ADZ

BEST FOR HEWING SMALL TIMBER IS AN *adz*, a tool made for this purpose and this alone. The adz is not so prevalent nowadays, nor is the ability to handle it, but the person who is eager for the skills of the woods will do well to look one up and catch on to the hang of it.

Like the ax, the adz is a tool for chopping wood, but it differs in that its blade is set at right angles to the handle. It is beveled on one side only and the blade is slightly arched. A conspicuous characteristic of the adz is its square or rectangular eye, which has given rise to the term *adz eye* as the name for all such square-cornered eyes wherever they are found.

In using the adz, one straddles the log and swings it downward between his legs. It will eat away the wood with remarkable ease. Its slightly arched blade prevents it from biting in too deeply, or removing too much wood. It leaves the small chip-shaped indentations or tool marks in the surface that are one of the chief charms of hand-hewn timber.

The adz is an efficient tool but in the same breath it must be said that it is a dangerous one, particularly to be respected. The very position one assumes in using it makes it hazardous to the legs. The legs, therefore, should be spread well apart, and the adz handled with great caution on each stroke. Only after long practice can it be treated casually.

In hewing to a line, after the rough work is done hoist the log on a sawbuck and shave it carefully either with ax or adz.

There are several types of adzes. The common one, and that best-suited for use on logs, is the *carpenter's adz*. These can be had with a half-head or a full-head.

A *hand adz* can be improvised from a small ax head as shown in the drawing.



HALF-HEAD



ADZ EYE



FULL-HEAD



SHIP CARPENTER

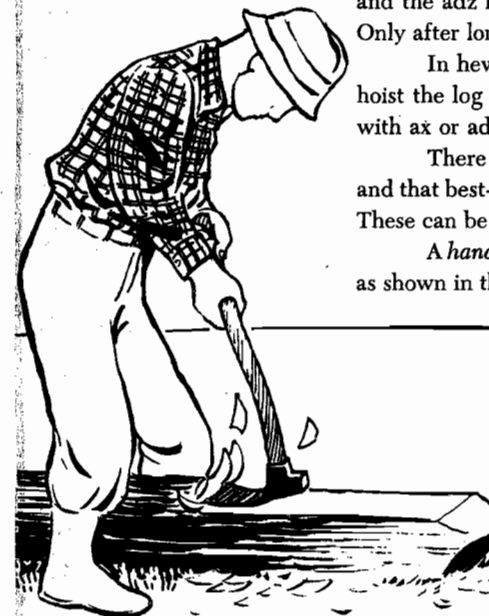

HAND ADZ

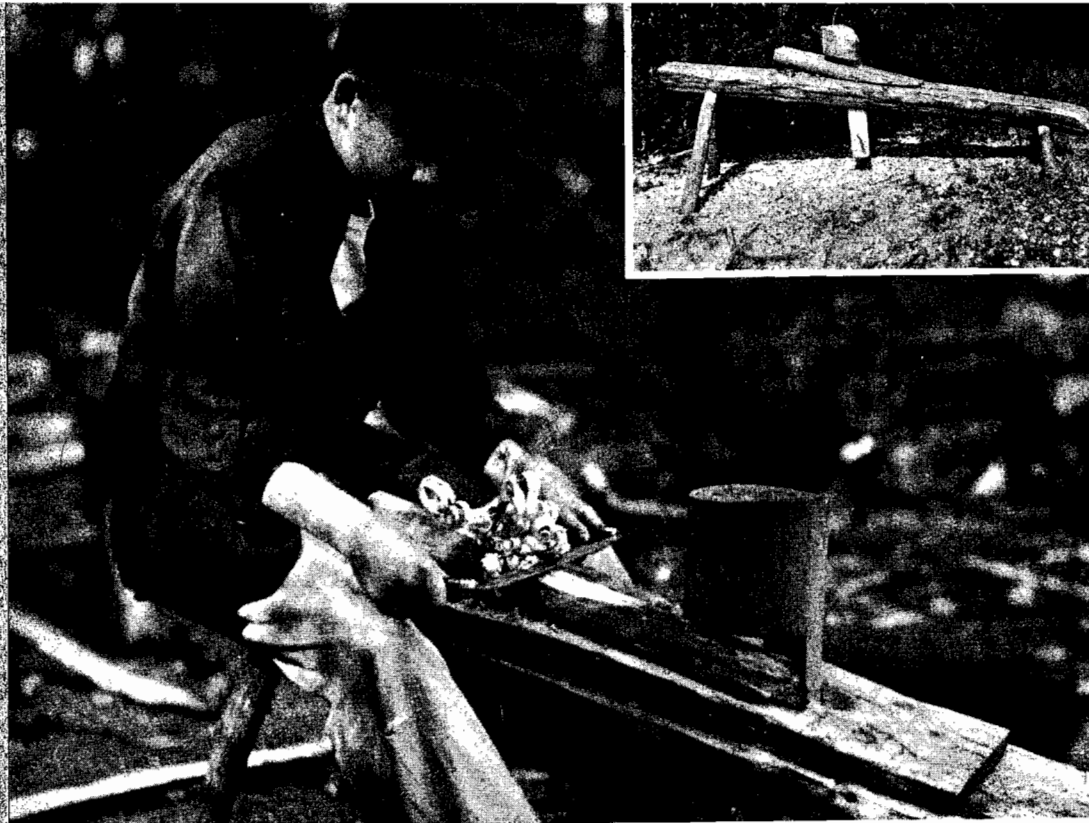

## SHAVING HORSE

THE OLD HORSE OF THE PIONEERS is a log device for holding a stick while it is being shaved down with a drawknife. It grips as firmly as any vise, and you can sit down while you work! One should be had wherever rustic work goes on.

To make one, three logs are needed, 10, 8, and 6 inches thick respectively. Let us hope they are cedar, otherwise some softwood. Saw off 8 feet of the largest log, and split it in half. One of these halves is to be the main bench. Get it standing on its legs, 24 inches high at one end and 12 inches at the other, drilling the leg holes with a 2-inch auger. Then cut the rectangular hole shown at D.

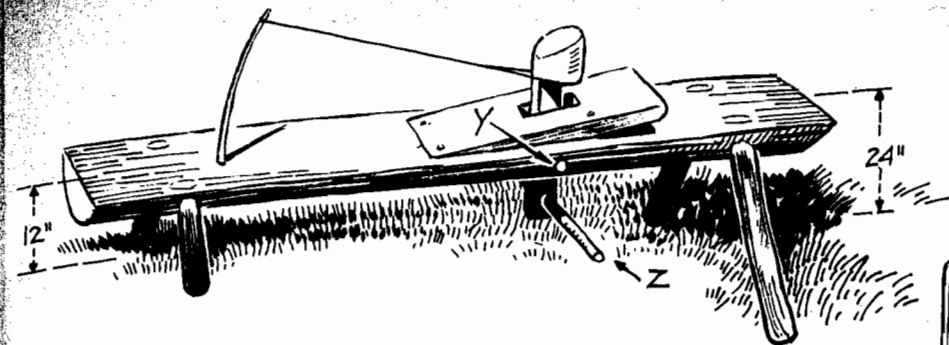

Now from the 8-inch log, saw off a piece 27 inches long, split in half, and shape one of the halves as shown in C. Note that it remains full thickness for a distance of 8 inches, then tapers to the end. Cut the hole in it of the exact size and shape of the one in D, place it over D, and peg in place by drilling 1-inch holes.

Next, from the 6-inch log, saw a piece 25 inches long and shape it into the clamp shown in B. Note that at a point 6 inches from the top, the log is sawed to form a square shoulder, and that the wood below it is then cut away to the rectangular shape shown.

Insert the clamp in the horse, and drill the hole for the pivot peg (Y at the top of the page). To do this, place a 2½-inch block beneath the shoulder of the clamp to hold it at the proper height, then drill a 1-inch hole through both the bench and clamp. Remove the clamp and enlarge the hole in it slightly so that when the 1-inch peg is driven through, it will serve as a pivot permitting the clamp to rotate. Insert the clamp in the horse and drive the peg. Finally, insert the stirrup peg at the bottom of the clamp, shown at Z, and the horse is completed.

If desired, a green branch and a string can be applied as in the drawing, to hold the clamp open.

Mount the horse, insert the stick to be shaved under the shoulder of the vise, place your feet on the stirrups and push. This clamps the shoulder down on the stick and holds it fast, so that you can go at it with drawknife, crooked knife, hunting knife or jackknife.

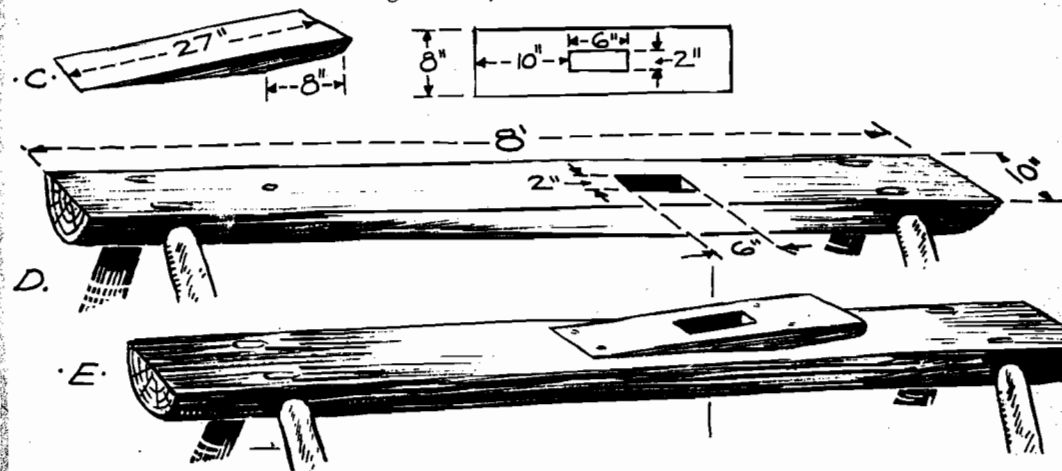

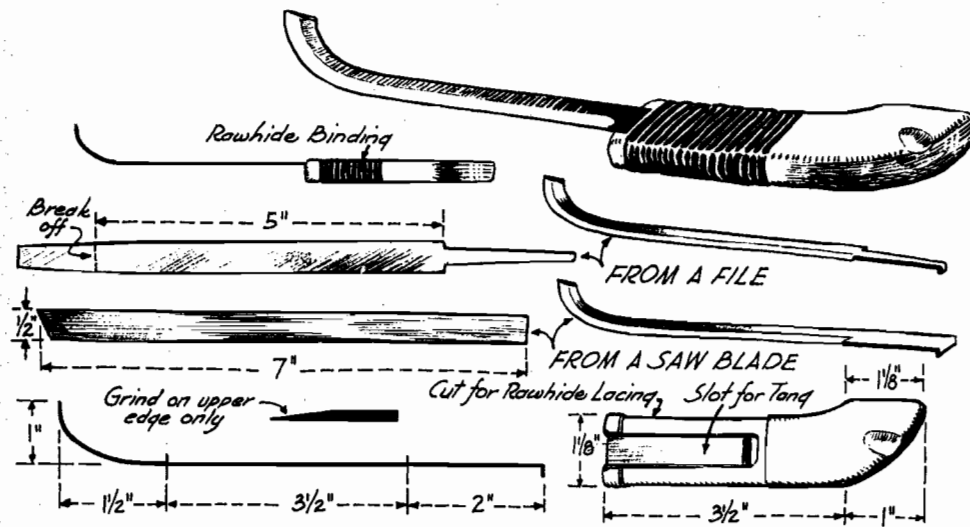

### CROOKED KNIFE

HERE IS THE WHITTLING KNIFE, the drawshave, and the gouge of the North-woodsmen, from New England across to the Pacific, and as far north as men live, learned from the Indians and Eskimo before them, who made it from bone or copper before the days of steel. Where tools are few, it is the right knife to have. To learn the knack of it is to possess one of the good arts of the woods.

Crooked knives are held with knuckles down and are pulled *toward* you, an awkward movement at first but rewarding in the end.

Use an old 7-inch mill file or piece of saw blade. The method of making is clear in the drawings. Note that it is beveled only *on one side*, as on a drawknife. The bevel is carried back half the width of the blade. Be sure you bevel on the right side—study the drawing. A blacksmith will bend and temper it. Particular care should be taken in shaping the handle as shown. The blade is bound to the handle with a wet rawhide thong which shrinks as it dries.

As shown the knife is for a right-handed person. Reverse it if left-handed.

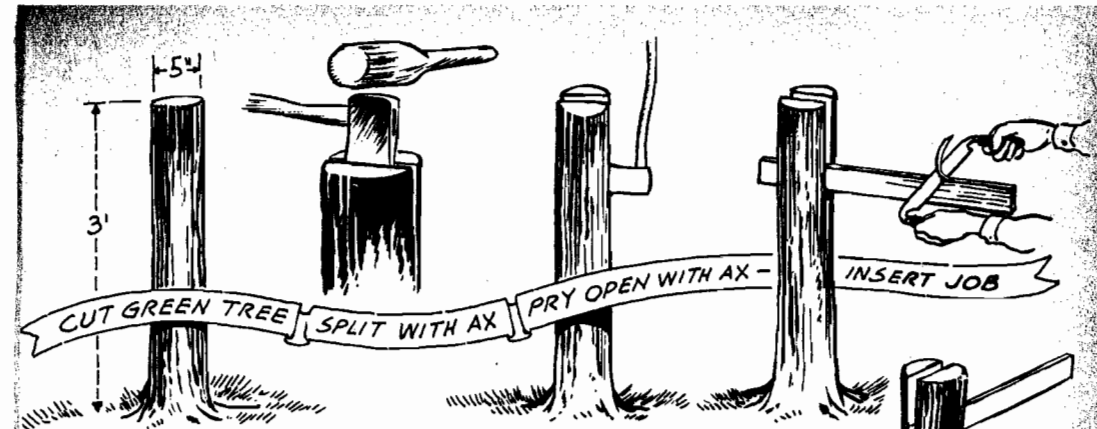

### STUMP VISE

WHEN A VISE IS NEEDED IN A HURRY, make it from the stump of a green sapling, felled three feet from the ground. Split the top with an ax and maul, pry it open and insert the stick to be worked on. This will grip it tight enough for almost any purpose, but if more pressure is needed, apply a tourniquet. That will squeeze it until the sap oozes out the top!

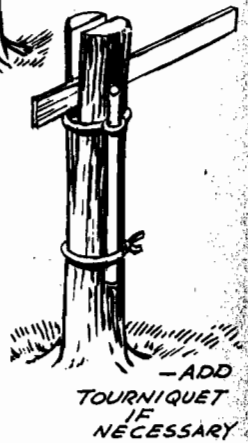



BARK SPUD

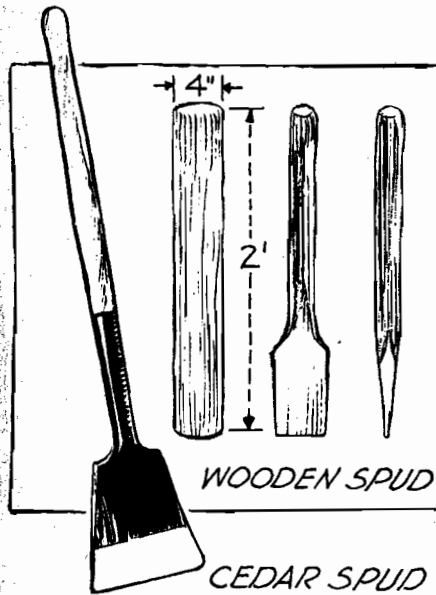

## BARKING

BARK CAN BE PEELED VERY EASILY during the sap-flowing months of the spring and early summer, but only with difficulty thereafter. If peeled logs are wanted in quantities, they should be peeled before the dry stretch of summer sets in. Winter-cut logs will not peel until they thaw out in the spring and the sap left in them comes to the surface.

As a rule the bark of summer-cut logs can be removed only by shaving it off with a drawknife, and that is a long and dreary job. Of course the different kinds of trees vary in the ease with which the bark will peel at any time of year. White cedar, for example, peels at any time, and while the bark will not slip in summer it nevertheless seldom binds fast. White pine and Norway pine, on the other hand, cannot be peeled at any time of year, and must be drawshaved.

Bark can be peeled with an ax if necessary, but the proper tool is a *spud*, as seen in the drawing. The hook at the side is used for ripping the bark and the flat end for prying it loose. This spud is used when the bark is to be ripped off and discarded; if it is to be removed in sheets and preserved, the wider and flatter *cedar spud* is better.

A spud can be made Indian fashion from a green sapling. Cut off a two-foot length, work one end of it down wedgeshaped, and shave down the handle to fit the hands.

Logs are often peeled where they are cut, which has the advantage of leaving the bark in the woods so as not to litter up the campsite or yard, but it has the one big disadvantage, especially in the spring, of leaving the poles so slippery that they are extremely hard to handle, load and haul. If possible, leave the bark on until the logs are on location.

Thus far we have assumed that the bark is peeled off to get rid of it, but sometimes it is peeled in order to get the bark, with no immediate need for the logs, as for example, in making a bark wigwam, or bark shingles. Then the need is for large sheets of unbroken bark, which can best be removed from *standing* trees. This becomes a serious matter, for *stripping the bark usually kills the tree*. Never under any circumstances should the bark be touched in a park, summer resort or populated area, and never any place without the owners' permission unless far back in the wilderness,

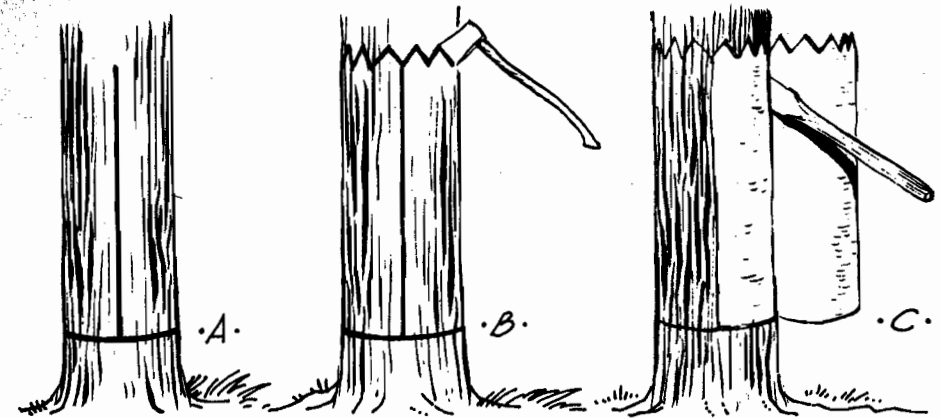

**STRIPPING BARK KILLS THE TREE —**  
— never do it unless you REALLY MUST have its bark!

and even then we should always ask ourselves, "Do we really need this bark?" Moreover, the location of the stripped tree should be remembered so that later on the tree can be taken down and put to use.

The bark of white cedar is preferred above all others for making shelters. Select large trees, the larger the better, and those that are symmetrical and free from knots.

First, girdle the tree around the bottom as in A, and slit the bark upward as far as can be reached. Then girdle it at the top, but since this cut is overhead, it can only be done by holding the ax at an angle, making the zigzag cut shown in B. Pry open the vertical slit with an ax, and then, working very carefully with a spud lest the bark be split, force the sheet loose all around. If there are other valuable sheets higher up, fell the tree to remove them. Otherwise, the tree can be left standing until the log is needed. A tree a foot in diameter will produce a sheet of bark three feet wide, and a tree of twenty inches, a sheet upwards of five feet wide.

Place the sheets on the ground in the shade, inner side down, and lay logs across them to keep them flat until needed.

In another book, *Woodcraft*, I have described how to make bark shacks and wigwams.

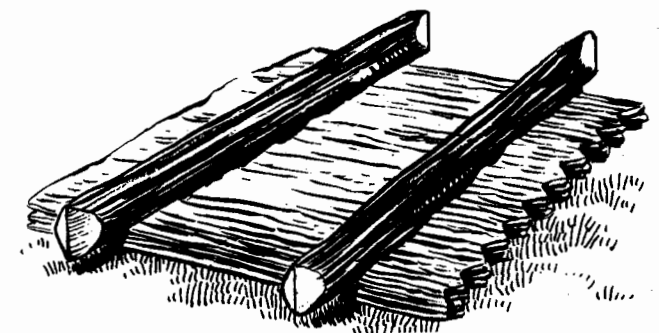

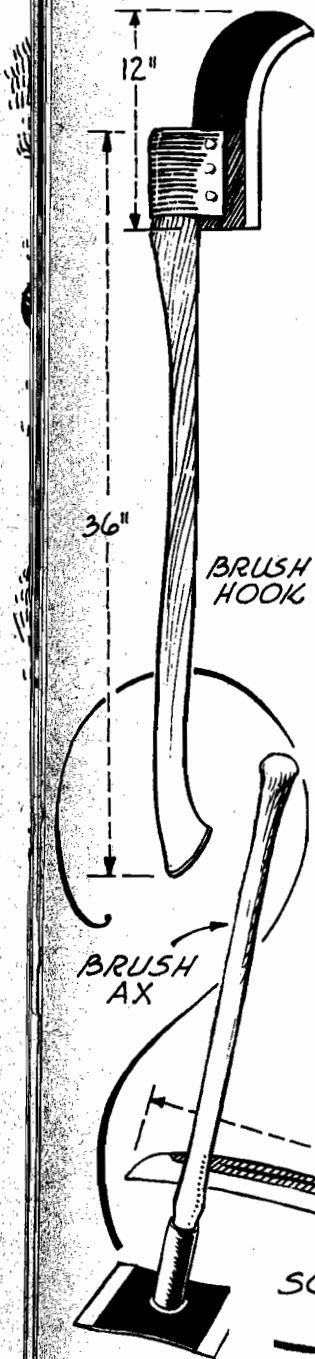

## BRUSHING

IF EVER YOU WILL APPRECIATE THE PROPER TOOLS it is in cleaning out a brush thicket or briar patch. A little of it can be done with an ax, but the right equipment will keep your disposition sweeter.

A sapling of size would, of course, be cut with an ax. Bend it with one hand so as to stretch one side of it and give it a slantwise cut as near the ground as possible. If one clip doesn't sever it, bend it in the opposite direction and repeat on the other side.

Smaller stuff calls for a brush cutter, of which there are many types. The most widely used and probably the best, everything considered, is the *brush hook*. Its hooked blade is a foot long overall, and is attached to a full-sized ax handle. Brush hooks come in all weights, corresponding to the weight of axes, and as in the case of axes the three-pound size is preferred by most men. The fact that one can stand erect and swing it like an ax gives it a wide advantage over the hand brush hook which is nothing more than a big hook-bladed knife.

Care should be taken to cut the brush as near the level of the ground as possible, so as not to leave the sharp, stiff stubble so annoying underfoot in cutover brush areas. This stubble, when left, can best be removed with a grub hoe or mattock, but it should not be left in the first place.

The *brush ax* is an ingenious tool with a blade that sits flat on the ground and a handle that extends upward at an angle from its middle. Sharpened on both edges, it is swung back and forth in front of you much like a grass-whip. It is capable of cutting the brush at the exact level of the ground, leaving no stubble at all, but it lacks the reach of the brush hook.

Another brush cutter is the *brush scythe*, set up like a grass scythe, but shorter and sturdier, attached to an ordinary snath or scythe handle, and handled as in cutting grass. Success with a scythe requires experience, and those not familiar with it will find a brush hook more to their liking.

The camper's preference in brush cutters is the *trail knife*—an

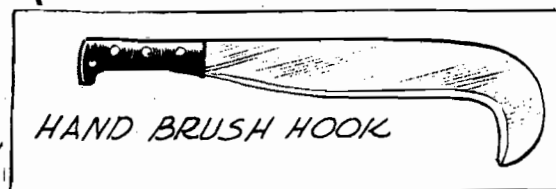

oversize hunting knife with a 10-inch blade, carried in a sheath on the belt. This is really a combination knife and hand-ax, capable of cutting brush, felling saplings up to several inches in diameter, and splitting small firewood. These big knives bring to mind the still larger *machete*, of which there are endless patterns, but the typical machete is more effective on cane and other softer vegetation than on brush.

Once the brush is cut, an ordinary *hayfork* or *pitchfork* is best for gathering it up and piling it. Small brush is handled in much the same way as hay, and requires the same three-pronged fork with 12-inch tines. Indeed, forks find many uses in the woods. For example, in cleaning up chips, bark leavings, log trimmings, and the other wood debris around the skid-pile, a scoop fork is ideal, such as the *barn fork* shown in the drawing, or a *manure fork*.

How to dispose of brush and slash is always a problem. In the old logging days it was left lying where it was cut, but nowadays orders are given in each logging operation for its disposal, depending on the needs of the forest—orders to scatter it uniformly and leave it to rot, or to pile it for burning—this much to the disgust of the old-time lumberjack who can see no point to tidying up the wilderness in this way. But the forester, with an eye to the well-being of the trees, sees it differently. Brush should be burned only in a clearing, and on solid ground with all debris cleared away, and then only after a rain. A burning brush pile should never be left unguarded. Indeed, burning brush is one of the commonest causes of forest fires. Such a horrible thing is a forest fire that no man's conscience could be at ease if he felt himself responsible for one through carelessness.

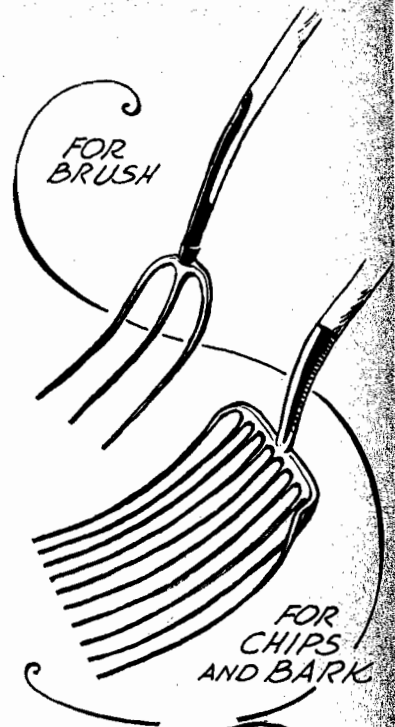
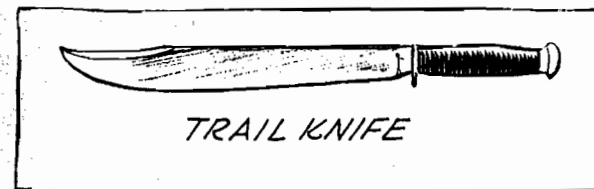

To fell a sapling, bend it and give it a slantwise cut near the ground.

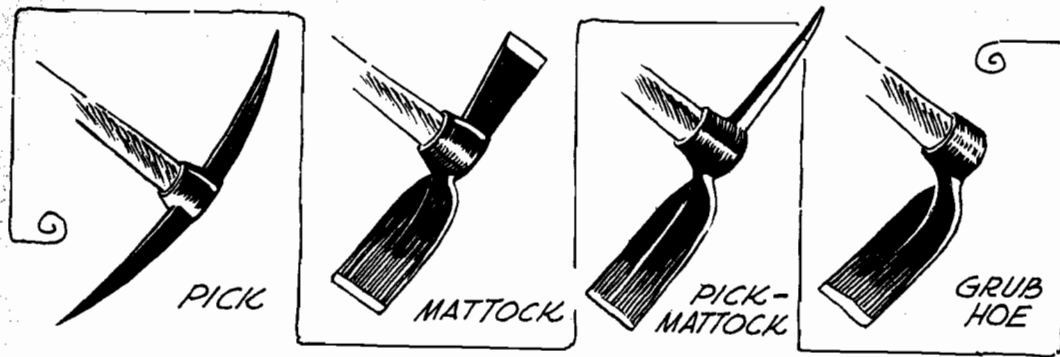

## GETTING DOWN TO ROOTS

IT IS THE BUSINESS OF SOME TOOLS to work in the ground but the ax is not one of these. If the tools for the job are not at hand the temptation is strong to use the ax. The moral is clear—a companion to the ax is needed to take care of the dirty work. That tool is the *mattock*.

We see it in the picture: It has two blades, one hoe-like and set cross-wise of the handle, and the other ax-like and set in line with the handle. Both are of softer steel so that they will not chip, yet have teeth enough to cut all smaller roots. Working in the dirt is the mattock's business, its hoe blade loosening and raking it away, and its ax blade taking out the roots.

In the woods the mattock is more to be desired than a *pick*, which serves no purpose other than to loosen earth. Only when attacking extremely hard-packed earth would a pick be needed. The *pick-mattock* is a combination of the two, with a hoe blade on one side and a pick replacing the ax blade on the other. It, too, is a second choice for working around roots, where the ax blade is more useful than the pick. The mattock is often called a *cutter mattock* to differentiate it from the pick-mattock. A *grub hoe* is a half mattock, capable of doing rough heavy duty, but lacking the root-cutting blade.

The woodsman who has much clearing to do finds his best tool in the *mattock ax*, variously called a *Pulaski*, *clearing ax*, or *forester's ax*. This is a full-grown ax of high-tempered steel for chopping, with a mattock blade extending out from its pole for grubbing and loosening the earth. Such a high-powered ax is, of course, more efficient than a mattock, but, by the same token, it must be

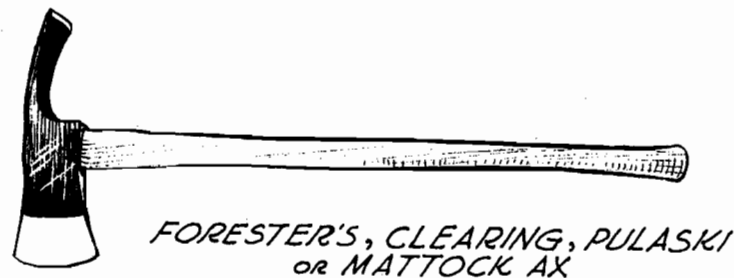
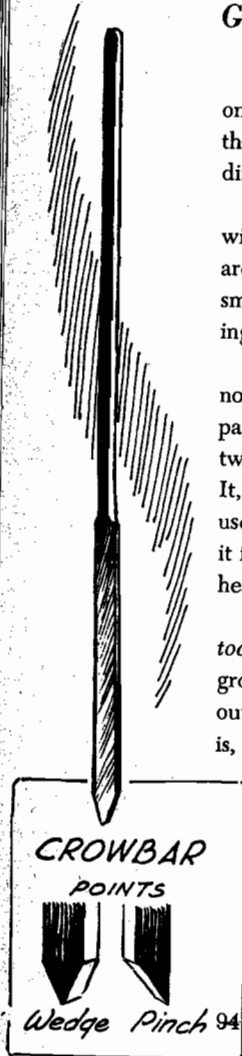

handled with all the caution due any ax in working in the ground.

In digging out a stump, the earth must be removed for some distance around so as to expose the roots. For this a *round-pointed shovel* is needed. A *spade* is more at home in the garden and around the lawn than in the woods, excellent for cutting sod and "spading," but not for shovelling earth.

As with everything else, there is a right way and a wrong way to shovel: Hold the end of the handle in the right hand, and grip it near its middle with the left. Bend the left knee slightly, place the left hand on top of the left thigh, and hold the right hand close in to the right hip. Thrust the shovel into the earth by leaning the body to the left and forward. This utilizes the weight of the body and relieves the arms and back of doing all the work. When the shovel is lifted, the handle is pried against the thigh.

To dig a stump out completely by hand is considerable of a task, for one must go deep, digging a hole large enough to get at the underneath roots with ax and mattock. After the large side roots are cut, a *stump-puller* such as described in the next chapter will be appreciated.

A *crowbar* is particularly useful in loosening earth deep down in a hole which cannot be reached with mattock or pick, as in digging a hole with a posthole digger. The point on a standard crowbar is wedge-shaped, but a pinch point makes a more versatile tool of it, especially useful in moving objects because it is easier to force underneath. Such a bar is often called a *pinchbar*.

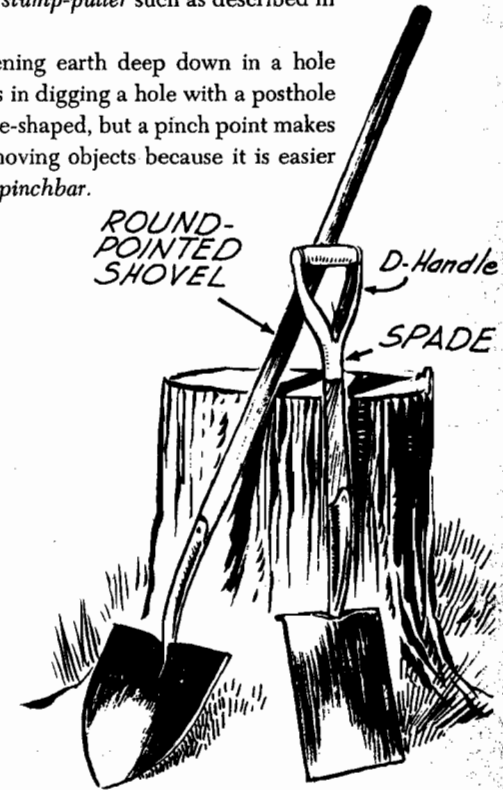

## TAKING THE STUMP

ANYONE CAN GET THINGS done with all modern machinery to help him. It would be a breeze to rip a stump out with a caterpillar or bulldozer, or even with a system of pulleys and a team. The important thing is to figure out how to get it done with what tools are at hand. In the woods those tools are apt to be few and simple.

The *mallet stump-puller* shown below can be made anyplace, and it increases one's pulling power by six. This jumbo mallet has a head 30 inches long and 18 inches wide, made of white cedar or other softwood for lightness, since very little strain is placed upon it. But the handle should be of wood tough and strong, such as hickory, elm, or ironwood. It measures six inches thick and six feet long.

Place the head of the mallet as close to the stump as possible, with the handle extended upward as in the picture. Wrap a chain around the stump and then around the handle as shown, stretching it as tight as possible, for precious power is lost with every bit of slack. To the top of the handle attach a pull chain at least 12 feet long, the end of which is hitched to the team. As the handle is pulled down to the ground the stump is turned up over the mallet head. It is as if six teams were pulling it.

What if there is no team? Well, a group of men can pull it—six men multiplying their power by six means that 36 are pulling, and that is considerable pulling power. In that case a rope should be used instead of the pull chain.

If the stump is too large to pull, dig the dirt away from around it with a mattock and chop the larger roots extending out to the sides. As it is being pulled, a man standing by with an ax can facilitate matters by chopping any large roots as they become exposed. A device of this sort is, after all, designed for use on small stumps. Large stumps usually cannot be pulled at all but must be dug or blasted out.

The easiest way to make the hole for the handle in the mallet head is to bore several holes with a 2-inch auger and then chisel out the wood between them. To make the handle secure, bore a hole in from the side of the head and peg it.

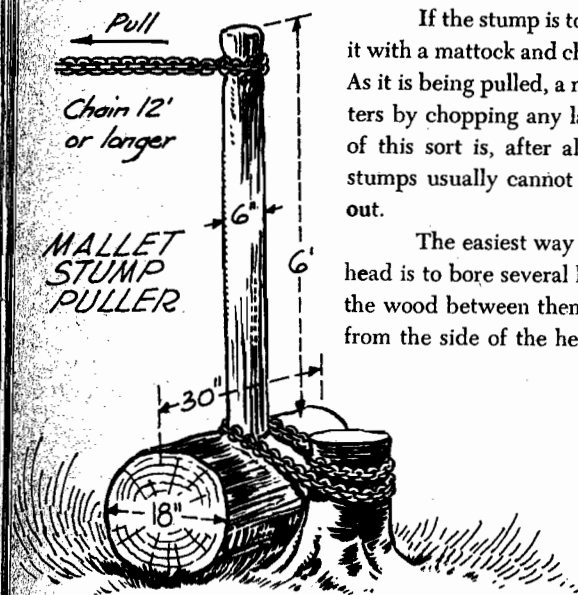

## MORE POWER TO YOU

HERE IS ANOTHER OF THOSE SIMPLE MACHINES that gives one man the strength of many. Capable of pulling a stump or moving a heavy object, it can be quickly rigged up with the aid of a good strong rope.

Tie the rope securely to the stump, and anchor the other end to a tree. Find a six-inch log, cut off about eight feet of it, and remove the bark. Midway between the stump and the tree dig a hole about two feet deep, and just wide enough to receive the log and permit it to revolve. A turning pole about six feet long is now needed. Twist the rope once around the upright post and shove the pole through the loop as shown in the picture. With one man at each end of the pole, start turning the post, wrapping the rope around and around it.

This winch creates great power, and wherever power is created there is danger. Something must give, and if not the stump it may be the rope. Be sure of your rope, that it is amply strong, and apply pressure slowly, little by little until the stump turns over. Violence wrecks things. When ropes break under tension they fly violently and can injure severely.

Be sure, also, that the rope is securely tied to the stump, so that it will hold even when the stump begins to turn. If the stump is tall and gives good surface, a timber-hitch may be used. A better way, if conditions permit, is to run the rope over the top, cutting a groove for it to rest in, and tie it to a large root on the far side. If the rope comes loose it is as bad as if it breaks. Be sure to cut all large surface roots before starting.

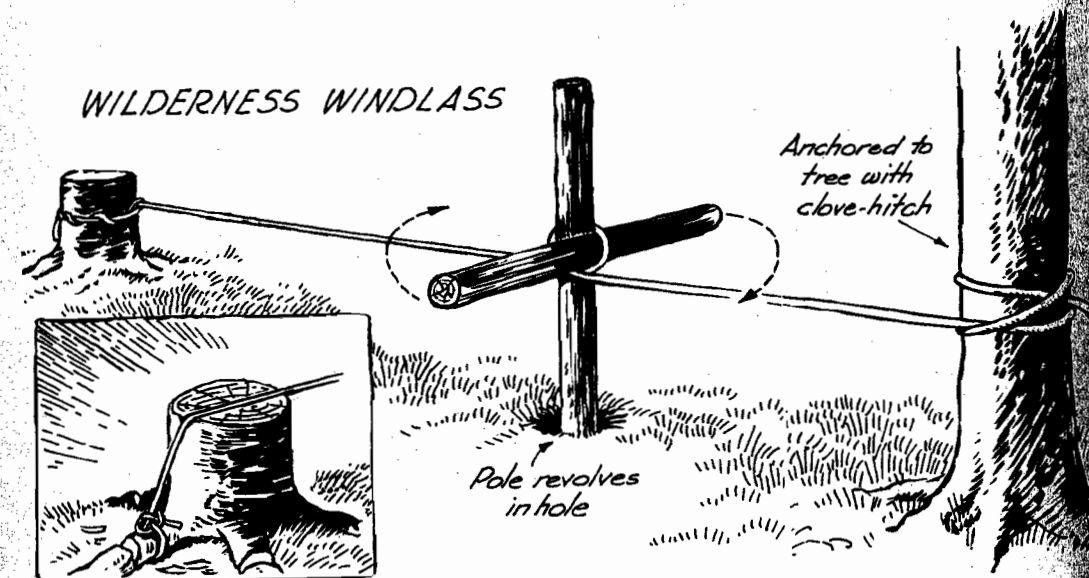

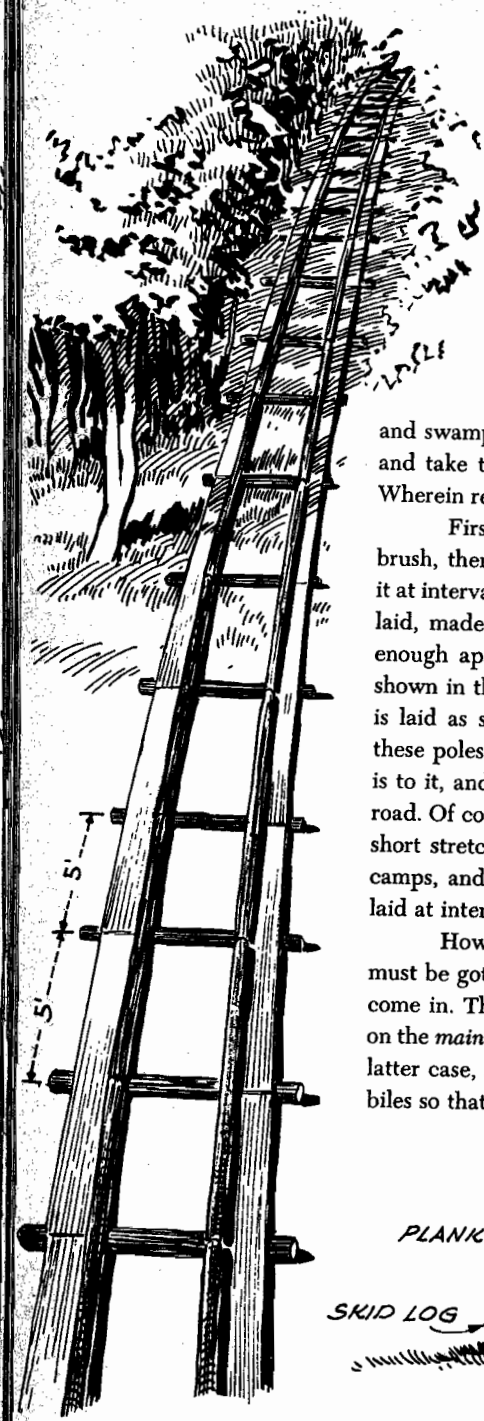

## WILDERNESS AUTO TRACKS

THE ROADS DWINDLE DOWN TO LANES, and the lanes to cowpaths, and the cowpaths fade into the deer tracks of the wilderness, but still the automobile continues to function. Far beyond the road's end in the logging country, the "walking bull" makes the rounds of his out-camps in his coupe, and the delivery truck carries supplies to the kitchens. Not on roads in country wet and swampy at times of the year, for roads would cost too much and take too long to make, but on *board tracks* do they travel. Wherein rests a plan exceedingly practical in all such situations.

First, the swamping crew must clear the way of stumps and brush, then a skid-road is laid by placing skid-poles crosswise of it at intervals of five feet. On these skids or "ties" the plank track is laid, made of one-inch boards a foot wide, and placed just far enough apart to accommodate the wheels of an automobile, as shown in the drawing. On the *inside* of these boards, a curb pole is laid as shown to prevent the car from running off the track, these poles being four to six inches in diameter. That is all there is to it, and it is done easier than in making any other kind of a road. Of course it is a one-way road, but it is usually used only for short stretches, as between the headquarters camp and the out-camps, and if longer stretches become necessary, side tracks are laid at intervals as on a railroad to permit the cars to pass.

How are the automobiles gotten into the bush? The logs must be gotten out by some means, and that is the way the autos come in. They may be floated in on water, or they may come in on the *main line*, as the logging company's railroad is called. In the latter case, an attachment is added to the wheels of the automobiles so that they can travel on railroad tracks as well as on roads.

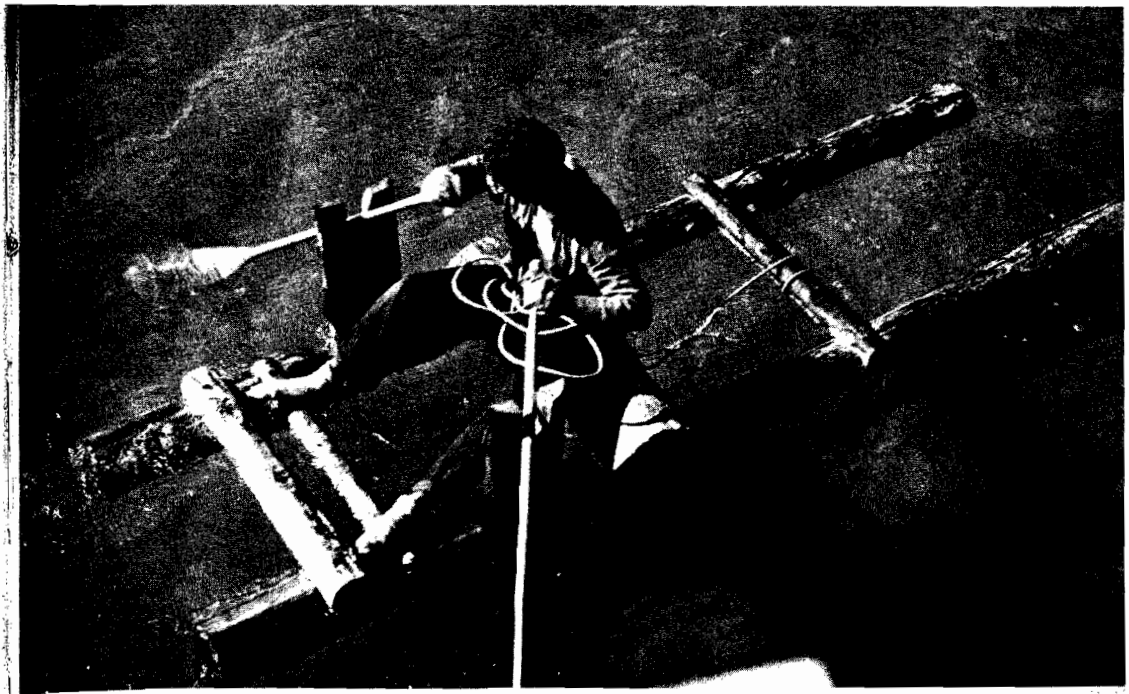
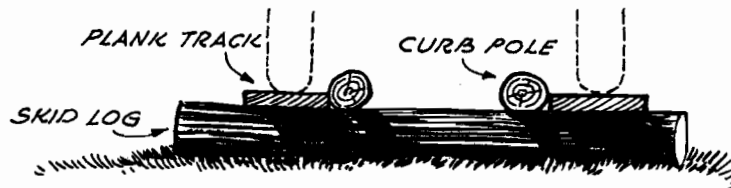

## CATAMARAN

THE TROUBLE WITH A RAFT is that you can't go anyplace with it. You might paddle or pole it a few rods out from shore to fish, provided there is no wind blowing, but it is too clumsy to navigate. The catamaran shown above, however, will take you there, and faster than you might think, for once it gets under way it clips right along. It was such made-on-the-spot craft as this that took the pioneers and woodsmen across the lakes when necessity demanded. It will do the same for you. The construction is clear in the photograph. From cedar or other softwood, make it nine feet long and three feet wide, with side logs eight inches thick. Wherever the logs intersect, square shoulders should be cut as shown in the drawing.

Never cross large expanses of water with this or any small craft unnecessarily. Especially beware of big water with a flat raft, for if an offshore wind should carry you out, you would have no means at all of controlling it.

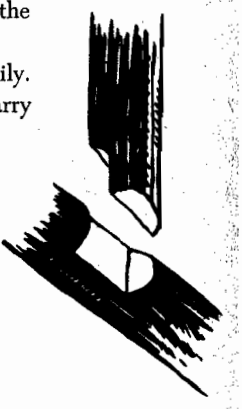





GRIP FOR  
A HAND-AX



GRIP FOR  
LARGE AX

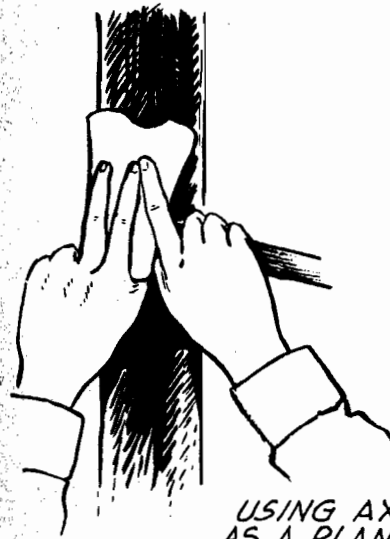

USING AX  
AS A PLANE

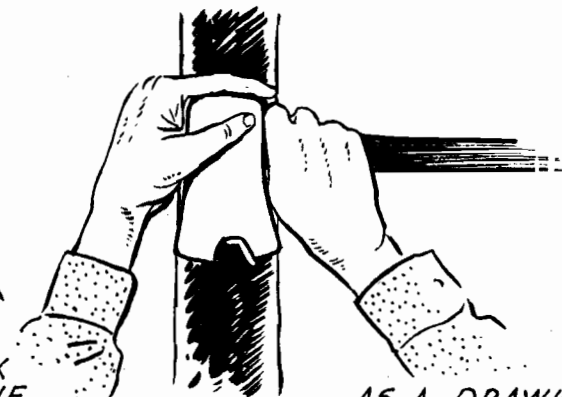

AS A DRAWKNIFE

## YOUR AX IS YOUR KNIFE

ONE GETS AX-MINDED IN THE WOODS and seldom thinks of his knife. The ever-present ax does it all from chopping logs to sharpening lead pencils to cleaning fish. And it takes care of any rough planing that needs to be done also! The more whittling one does with his ax the more certain he becomes that a knife is an unnecessary adjunct except for very fine work, and even for that the ax should not be brushed aside too abruptly. It is the case of getting the hang of it.

Of course it is assumed that the ax is sharp. There need not be any difference in sharpness between knife and ax.

A good whittling grip for a hand-ax is with the thumb on the pole as in the drawing. A large ax is better handled with two fingers across the blade, a position often used on a hand-ax also for very careful work. Grip the ax tightly to keep it under absolute control and, if at all possible, place the end of the stick on some solid object to steady it. Keep your left hand well behind the ax and your knees where they belong.

You will be surprised what a good plane an ax will make when held as in the picture, and what a good drawknife, too! But be careful in using it as a drawshave because you are moving it toward you—take short, jerky strokes and grip it tightly.

## SLAB PIGS

A BENCH TO SIT ON and a table to eat from are appreciated even in the roughest surroundings of a temporary wigan. A few small poles nailed to a framework might do for both, but more woodsman-like furniture will result from slabs or split logs.

Figs, as the slab benches are sometimes called, can be made in short order once the materials are at hand. It's merely a case of pegging in the legs, for which a two-inch auger is needed to bore the holes. After the leg is whittled to fit, its end should be split, then driven in and wedged. When the wood dries out, the leg will loosen and will need to be replaced. A better method, if the slab is thick enough, is to use a *blind wedge*: insert the wedge in the leg beforehand, so that when the leg is driven in, the wedge is forced into place. When the leg loosens, merely drive it in farther.

A table may be made from slabs or half-logs as shown. Wherever two round surfaces come together in log construction, they should be flattened so as to provide square surfaces.

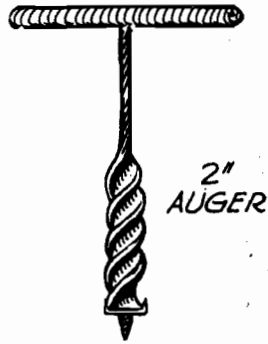

2"  
AUGER

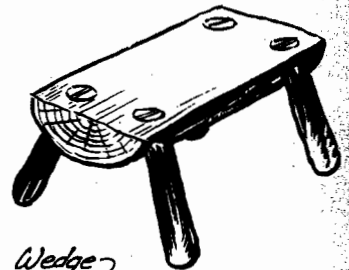

Wedge?

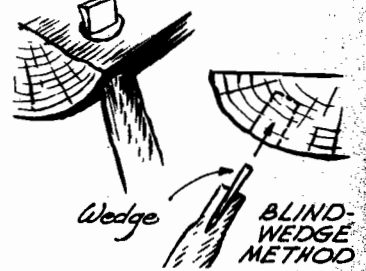

Wedge

BLIND-  
WEDGE  
METHOD

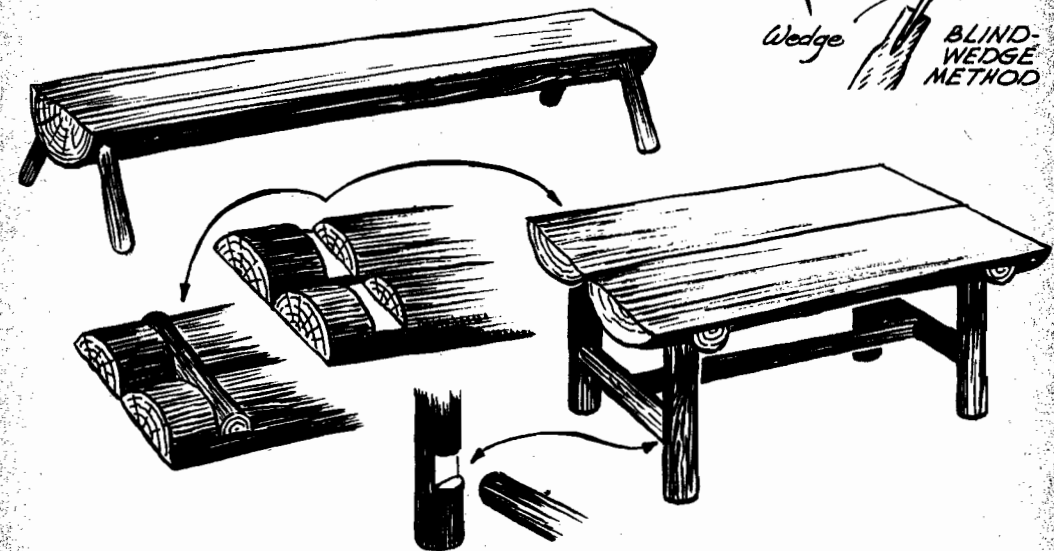

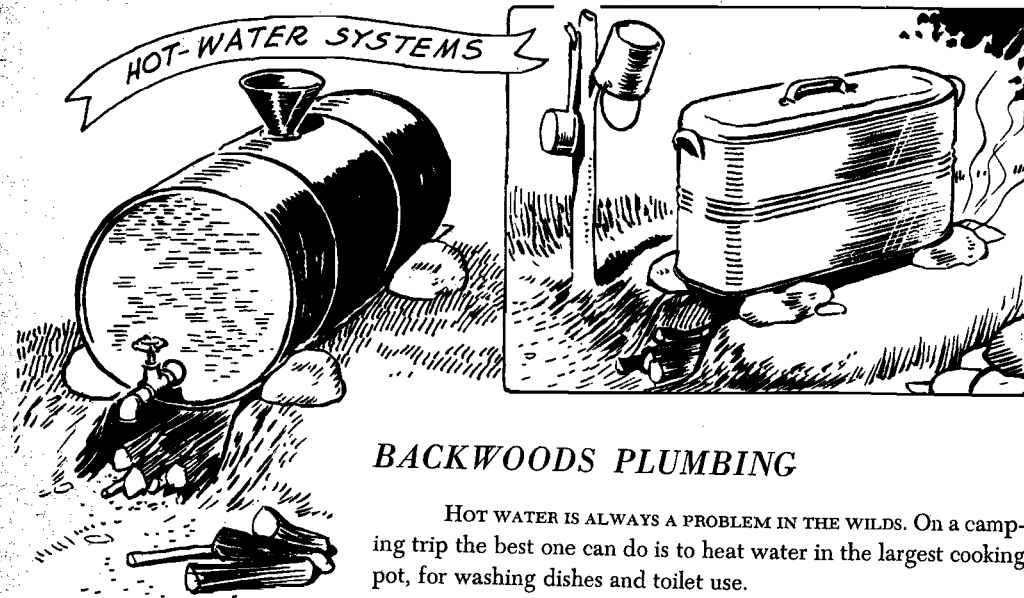

## BACKWOODS PLUMBING

HOT WATER IS ALWAYS A PROBLEM IN THE WILDS. On a camping trip the best one can do is to heat water in the largest cooking pot, for washing dishes and toilet use.

In a more permanent or fixed camp, it is good to have hot water on hand more or less constantly. This can be done by placing an old-fashioned wash-boiler over a trench fire as shown above, keeping the lid on for quick results, and hanging a bucket near by for dipping.

Another and better arrangement is to use a large oil drum with a faucet attached as shown, placed over a trench fire. The bung on the top can be left open permanently to allow the steam to escape.

A keg with a wooden faucet is good for drinking water. Indeed, the loggers often take little kegs containing about two gallons into the woods with them, with a handle attached to the side for carrying.



## DRINKING WATER

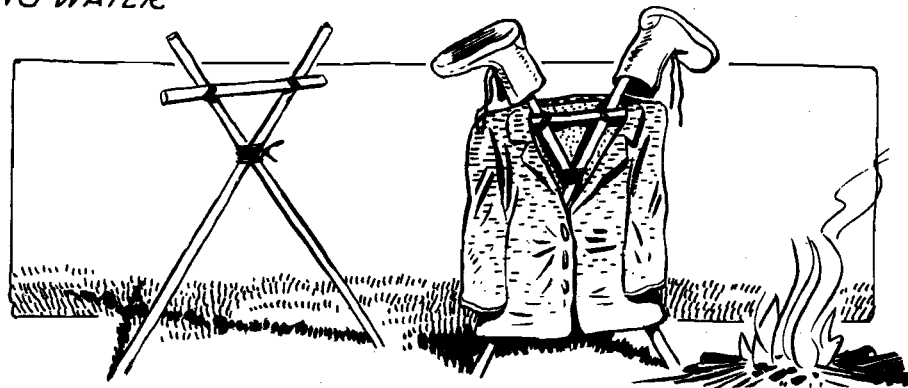

## WATER BOY

BEYOND THE PALE OF THE WATER PIPE AND FAUCET goes the water tank on wheels, and beyond the roads the water bucket takes over. With a yoke on his shoulders, he gives himself more hands with which to haul, and saves himself many steps. Shaped as shown, the yoke is of a  $\frac{3}{4}$ -inch board, well-rounded on the edges for comfort. The suggested dimensions may vary somewhat with the size of the man. The ropes are short enough so that the buckets on them ride above those carried in the hands. When the buckets sway so as to splash water, they may be steadied with the arms, or by bending your fingers under them as you carry the hand buckets.

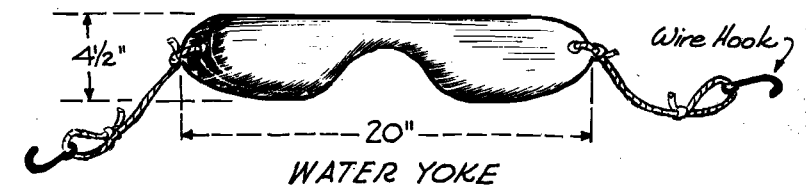



## GIVING 'ER SNOOSE IN THE ROLEO

COMES ROLEO TIME and the loggers gather from miles around, to sit with old friends and spit and gossip, to recollect Paul Bunyan history, to prove their bush-whacking worth by shaving with their double-bitted axes, and above all, to match their might with all who come in the logging events of the day. Here are typical contests:

*Bucking Contest*—This is a contest to see who can saw a log with a bucksaw fastest. Use an 8-inch log, from which a 12-foot section is cut and rested on two

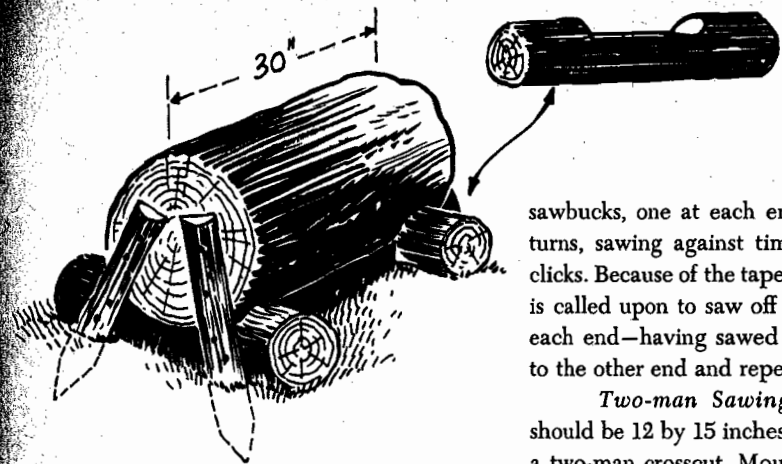

sawbucks, one at each end. The buckers take turns, sawing against time as the stop-watch clicks. Because of the taper in the log, each man is called upon to saw off *two* pieces, one from each end—having sawed one, he runs quickly to the other end and repeats.

*Two-man Sawing Contest*—The log should be 12 by 15 inches in diameter; the saw a two-man crosscut. Mount it on skids so that

the ends extend free. Each pair of contestants saws off a disk from the end, and the low time wins.

*Pole-chopping Contest*—Use poles 8 inches thick, cut into 6-foot lengths, all of the same species. A handax is used. The man chopping through first wins. Give the choppers ample room, for the event can be dangerous in the excitement.

*Log-chopping Contest*—This is the standard chopping contest. Use 15-inch logs, cut into 30-inch lengths. Mount each bolt on crosswise chocks as shown. The axmen chop from on top the log, cutting a V in one side, then turning to cut the other side. The man wins who first cuts his log cleanly. The notch may be outlined with crayon beforehand, and footholds cut.

*Skidding*—Teams of four men snake or drag a log with a rope 100 yards against time. The log should be a foot in diameter and ten feet long, to which the rope is tied with a timber-hitch as described on page 46.

*Pulpwood Throwing Contest*—In this the loggers match their skill in throwing bolts of pulpwood with their pulphooks as pictured on page 42. The target is a small tree 15 feet from the throwing line. Use 4-foot bolts of softwood, cut from 6-inch logs. Each man throws three bolts, scoring 3 points for each hit on the fly, and 1 point for each hit on the first bounce.

*Birling Contest*—The log and the skills are described on pages 48-49. The two jockeys mount the log, one on each end, balancing poles in hand. At the signal "Throw your poles," each starts birling and snubbing in an effort to wet the other while he himself remains afloat.

*Spitting Contest*—It's all on the side, while sitting and talking things over. No other breed of men have such proclivities for distance or accuracy, or are more wont to prove it. To make a contest of it, a bean or cherry stone in the mouth helps the judges and improves the sanitation. There are two contests, one for distance and the other for accuracy with a tin can six feet distant as the target.

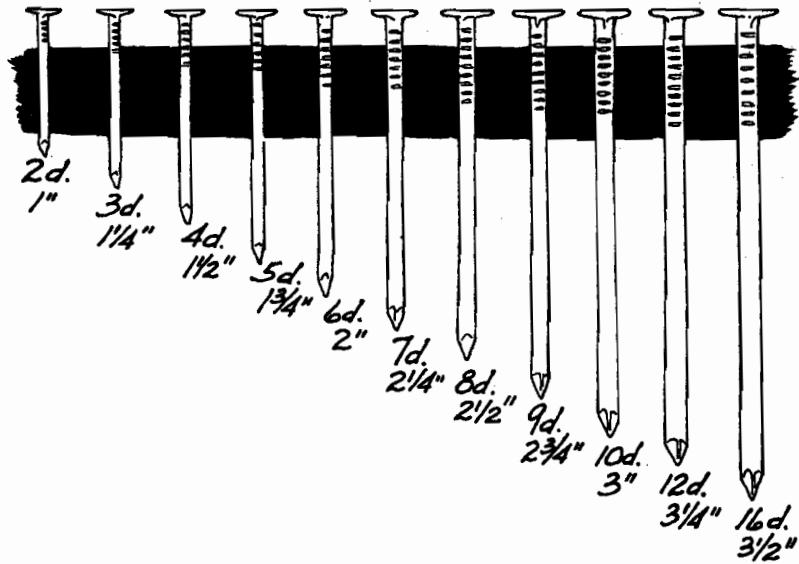

### NAILING DOWN THE SIZE

THE SIZE OF NAILS is expressed by the word *-penny*, the abbreviation for which is *d*. Thus there are *twopenny* nails, *threepenny* and so on up to *tenpenny*, after which the sizes range as in the drawing, up to *sixtypenny*. Beginning with the *twopenny*, one inch long, the sizes increase by one-fourth inch with each number up to *sixteenpenny*, after which they increase by one-half inch. The largest is the *sixtypenny*, six inches long, after which comes the spikes.

It is not necessary to remember all the sizes—fix the *tenpenny* in mind as three inches long, and from that you can easily name any other size you want. Other good sizes to have in mind are *sixpenny* (2 inches) and *twentypenny* (4 inches).

Spikes range in size from 7 to 12 inches, and are usually ordered by length, not by number. The 12-inch spike is much used in log work and is often referred to as a log spike.

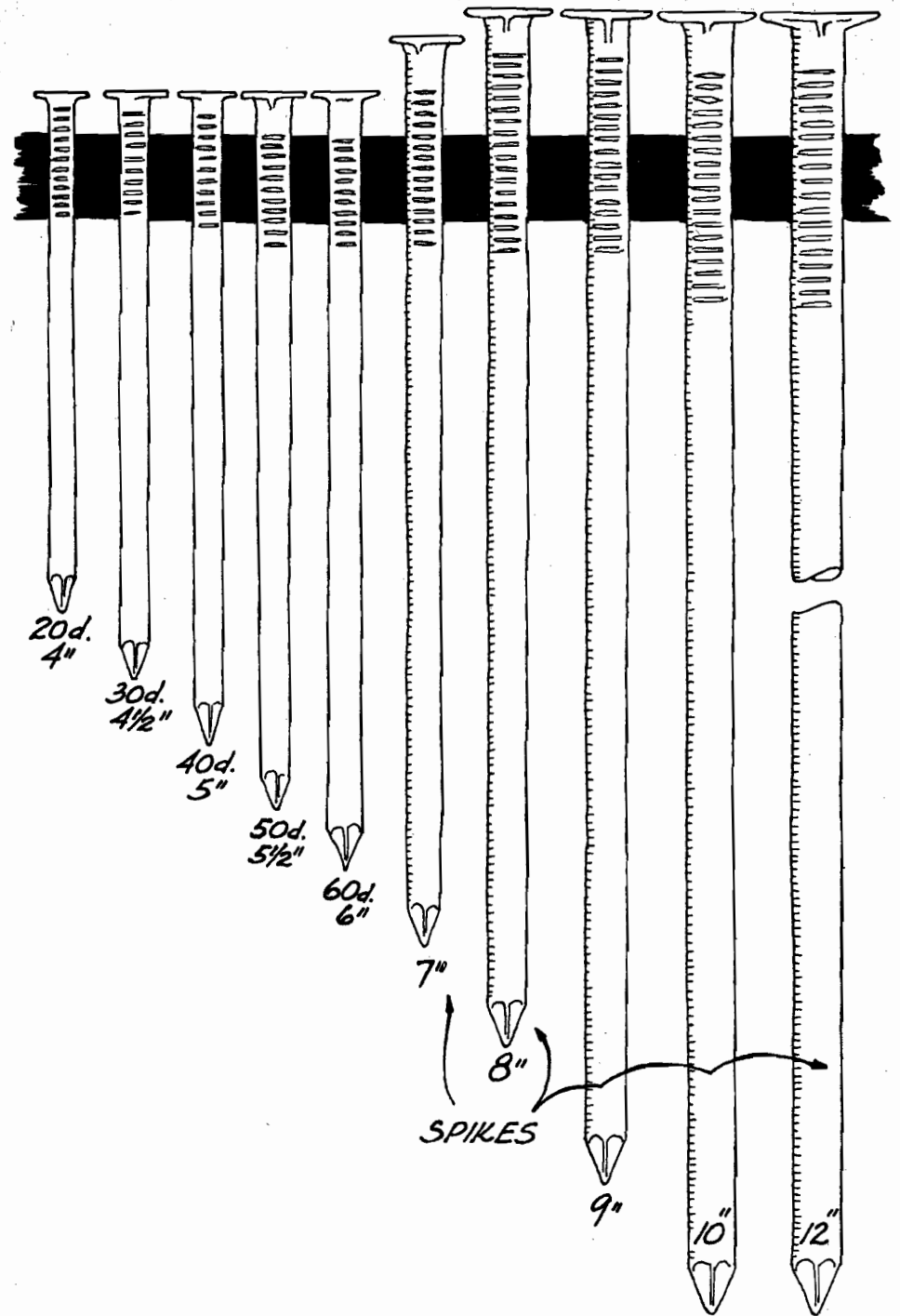

## LOGGING LINGO

backbreaker, *n.* A big log, usually more than 14 inches in diameter.  
ball-hooter, *n.* A logger who rolls logs down hillsides.  
bang juice, *n.* Dynamite.  
barber chair, *n.* A stump with a high projection like the back of a chair.  
bateau, *n.* A flat-bottomed boat, pointed at both ends, used by the river crews in the log drives.  
beaver, *v.* To hack a tree down in amateurish fashion.  
beetle, *n.* A large wooden mallet used in driving posts and wedges.  
belly, *n.* The curve in an ax handle.  
big 'uns, *n.* Big trees.  
blowin', *v.* Going to town to celebrate.  
board tree, *n.* A straight-grained tree, suitable for riving into clapboards.  
bog camp, *n.* A camp near a swamp.  
bonhomme, *n.* A piling jack.  
boom, *n.* A mass of floating logs held together for towing.  
boom-rat, *n.* One who rides logs in the water, and rafts them in booms.  
bow-saw, *n.* A bucksaw with a bow-shaped steel frame.  
Also "Swedish saw," "Swede fiddle," "pulpwood saw."  
boys' ax, *n.* A three-quarter ax, weighing 2½ pounds, with a 28-inch handle.  
bridge, *n.* The narrow section of wood which remains uncut in felling a tree, and which breaks as the tree falls.  
brier, *n.* A crosscut saw. Also "misery whip," "Swede fiddle."  
broadax, *n.* A large ax, the blade of which is bevelled on one side only, used in flattening logs, making ties, etc.  
broadax bridage, *n.* A crew of tiemen.  
bucker, *n.* One who bucks or saws logs into lengths.  
buck, *n.* A sawbuck.  
    *v.* 1. To saw logs into lengths. Also "log off."  
    2. To carry anything, as to buck water, or wood.  
buckeroo, *n.* One who rides or birls logs in the water and rafts them in booms. Also "log-jockey," "bucko," "river driver."  
bucksaw, *n.* A hand saw for bucking wood.  
bug, *n.* 1. A lantern made by inserting a candle in a hole in the side of a tin can.  
    2. A lantern of any type.  
bull, *n.* The camp boss or foreman. Also "bull-of-the-woods," etc.  
bull bucker, *n.* The head man of a crew of fallers and buckers.  
bull cook, *n.* A cook's helper or choreman.  
bull-pen, *n.* A bunkhouse  
bull-pen boy, *n.* A bunkhouse caretaker, Also "crumb."  
bullwacker, *n.* An oxen driver.

bunch, *v.*  
bunkie, *n.*  
Bunyan boy, *n.*  
burn the stick  
bushel, *v.*  
busheler, *n.*  
bushtail, *n.*  
bush-whacker, *n.*  
butt, *n.*

camp eye, *n.*  
camp inspector, *n.*

cant, *v.*  
can't cut 'er.  
cant-hook, *n.*

cat-skimmer, *n.*  
cedar saw, *n.*  
cheat-stick, *n.*  
chock, *n.*

*v.*  
choke strap, *n.*  
clapboard, *n.*  
cackler, *n.*  
come-along, *n.*

cold deck, *n.*  
cold skidding, *v.*

cord, *n.*  
cow's mouth, *n.*  
crosscut, *n.*  
crosscut saw, *n.*

crown, *n.*  
crown fire, *n.*  
cruiser, *n.*

cruiser ax, *n.*

To pile logs in small piles.  
A bed partner.  
A logger. Also "brush-rat," "rosin-belly," "sawdust-savage."  
To slide down a pole.  
To cut logs for pay by the piece rather than by the day.  
One who bushels; a piece worker.  
A horse.  
A logger. Also "brush-rat," or "ape," "Bunyan boy."  
The trunk of a tree from which the branches have been trimmed off.  
Camp watchman.  
A logger who never works long at one job, moving from camp to camp.  
To turn logs with a cant-hook.  
Cannot do. Also "can't hack 'er."  
A tool consisting of a metal hook or dog on a wooden handle, used in handling logs. Also "log-wrench," "mooley cow."  
One who operates a caterpillar tractor.  
A one-man crosscut saw for cutting small logs.  
A log-scaler's rule.  
A block or stone put under a log or wagon wheel to prevent it from moving.  
To place an object under a log or wheel.  
A necktie.  
A thin board split from a log, used for boarding or roofing.  
The camp clerk. Also "ink-slinger," "pencil pusher."  
A tool for carrying logs consisting of a pair of hooks hung in the middle of a handle. Also "lug-hook," "timber-carrier."  
A storage pile of logs.  
Skidding logs out of the woods at some future time after they are cut. They are piled when cut to await hauling operations later on. See *HOT SKIDDING*.  
A measure of wood, 8 feet long, 4 feet wide, and 4 feet high.  
A notch chopped in a tree to fell it, or in a log to cut it in two.  
A crosscut saw.  
A large saw for sawing logs crosswise, often used to mean specifically a two-man crosscut saw. Also "brier," "misery whip," etc.  
The top of a tree  
A forest fire in the tops of trees.  
1. A timber cruiser.  
2. A cruiser Ax.  
A double-bitted ax of the three-quarter size, weighing 2½ pounds, with a 28-inch handle.

crumb, *n.*  
 crutch, *n.*  
 cuff, *v.*  
 deacon's seat, *n.*  
 deadhead, *n.*  
 dead man, *n.*  
 dead log, *n.*  
 ding-dong, *n.*  
 doll buggy *n.*  
 donkey puncher, *n.*  
 double-bit, *n.*  
 down log, *n.*  
 double barrel, *n.*  
 dough-mixer, *n.*  
 drag one's feet.  
 dugout, *n.*  
 epsom salts, *n.*  
 faller, *n.*  
 fawnfoot, *n.*  
 fell, *v.*  
 flathead, *n.*  
 fool-killer, *n.*  
 frog, *v.*  
 gee, *n.*  
 Genuine Jimmy, *n.*  
 get a saddle.  
 give 'er snoose,  
 glut, *n.*  
 grandpa, *n.*  
 grease-burner, *n.*  
 ground-hog, *n.*  
 grunt, *n.*  
 gut-hammer, *n.*  
 gyppo outfit, *n.*

A bunkhouse caretaker. Also "bull-pen boy."  
 A pole used in place of a broken wagon wheel, placed under the axle and fastened to the bed so that the wagon will slide.  
 To keep the log in motion, in competitive birling, by kicking it with the feet.  
 1. A large seat by the fireplace in a bunkhouse, regarded as a place of honor—it is understood that it requires a good man to occupy it.  
 2. A seat on a log at the end of an Adirondack log lean-to, reserved for the best man present.  
 A log partly sunk in the water.  
 A fallen tree.  
 A log which will not float.  
 The dinner gong.  
 A two-wheeled cart.  
 One who operates a donkey engine.  
 A double-bitted ax.  
 A log that has fallen of its own accord.  
 A bunk or bed for two men.  
 The camp cook. Also "hash-burner," "kitchen mechanic," "mulligan-mixer," "stomach-robber," "sizzler."  
 To "ride" the saw or fail to do one's share in handling a two-man saw.  
 1. A water-trough made by hewing out the inside of a log.  
 2. A boat or canoe made by hewing out the inside of a log.  
 The camp doctor. Also "E. Possum Salts," "Genuine Jimmy,"  
 One who fells trees. Also "feller," "flathead."  
 The knob at the end of a curved ax handle of standard shape.  
 To cut down a tree.  
 One who fells trees (Southern). Also "faller," "feller."  
 A loose branch left hanging in a tree which may fall unexpectedly. Also "widow-maker."  
 To loiter, loaf, or work listlessly.  
 A command used by teamsters to turn the team to the right  
 The camp doctor. Also "epsom salts."  
 A warning not to ride the saw.  
 Give her snuff—an exhortation to work hard.  
 A wooden wedge for splitting logs.  
 The general superintendent.  
 A locomotive engineer.  
 A logger who works on the ground.  
 A helper.  
 A gong for calling loggers to meals.  
 A small independent logging outfit.

hair-pounder, *n.*  
 hang, *n.*  
 o.  
 hash-burner, *n.*  
 haw, *n.*  
 headache!  
 helve, *n.*  
 hogger, *n.*  
 hot skidding, *v.*  
 housewife, *n.*  
 Huh.  
 ink-slinger, *n.*  
 jackpot, *n.*  
 jam crew, *n.*  
 jerk, *v.*  
 jerky, *n.*  
 kerf, *n.*  
 kickback, *n.*  
 kitchen mechanic, *n.*  
 live log, *n.*  
 loco, *adj.*  
 lodged tree, *n.*  
 log-jockey, *n.*  
 log off, *v.*  
 log scale, *n.*  
 log-wrench, *n.*  
 long-butt, *v.*  
 lop, *v.*  
 lops, *n.*  
 lug-hook, *n.*  
 macaroni, *n.*  
 man-grabber, *n.*  
 maul, *n.*

A teamster.  
 The angle at which an ax head is placed on the handle.  
 To place an ax head on a handle.  
 A camp cook. Also "dough-mixer," "mulligan-mixer," "stomach-robber," "sizzler," "kitchen mechanic."  
 A command used by teamsters to turn the team to the left.  
 A warning to duck your head lest you bump it on a branch.  
 An ax handle.  
 A locomotive engineer.  
 Hauling logs out of the woods immediately after they are cut. Also "hot logging."  
 A kit of sewing articles for repairing clothes.  
 The sound emitted by a logger in swinging an ax; a sort of grunt.  
 The camp clerk. Also "Johnny Inkslinger," "pencil-pusher," etc.  
 Three or more trees felled one on top another, usually by accident, forming a pile difficult to untangle.  
 The crew in charge of a log drive.  
 To dry thin strips of meat in the sun.  
 Sun-dried meat.  
 The space made by a saw as it cuts through timber.  
 The action of a falling tree the butt of which jumps backward over the stump.  
 The camp cook. Also "dough-mixer," "hash-burner," "mulligan-mixer," "stomach-robber," "sizzler."  
 A log which will float.  
 Crazy.  
 A felled tree caught in and supported by a standing tree.  
 One who rides or birls logs in the water, and rafts them in booms. Also "buckaroo," "bucko," "river driver."  
 To saw logs into lengths (Southern). Also "buck."  
 A scale or rule that shows the number of board feet in a log. Also "cheat stick."  
 A cant-hook. Also "mooley cow."  
 To buck off the rotted part of a log as waste.  
 To chop or trim off branches.  
 1. Branches trimmed from logs. Also "slash."  
 2. The branches and tops of standing trees.  
 A tool for carrying logs consisting of a pair of hooks hung in the middle of a handle. Also "timber-carrier," "come-along."  
 Sawdust.  
 An employment agent. Also "man-catcher."  
 1. A club-shaped wooden tool for driving wedges.  
 2. A metal sledge for driving wedges.

misery whip, *n.* A crosscut saw. Also "Swede fiddle," "brier."  
 mooley cow, *n.* A cant-hook. Also "log-wrench."  
 mud hen, *n.* A swamp worker. Also "swamp angel."  
 mule-skinner, *n.* A mule driver.  
 mulligan-mixer, *n.* The camp cook. Also "dough-mixer," "hash-burner," "kitchen mechanic," "stomach-robber," "sizzler."  
 muzzle, *n.* An ax sheath.  
 nose, *v.* To round off the edges at the end of a log to facilitate skidding. Also "snipe."  
 Now you're loggin'!  
 pac, *n.* An expression of praise or commendation.  
 pay-cheater, *n.* A boot with a moccasin-type sole.  
 peavey, *n.* A timekeeper.  
 peckerwood mill, *n.* A tool for handling logs, similar to a cant-hook except that it has a pike at the lower end of the handle.  
 pencil-pusher, *n.* A small portable sawmill (Southern).  
 pike, *n.* The camp clerk. Also "ink-slinger," "cackler."  
 pike-pole, *n.* A metal point or spike, usually attached to the end of a pole.  
 piling jack, *n.* A long slender pole with a pike or metal point attached to the end, used in handling logs in the water.  
 piling skid, *n.* A notched log leaned against a log pile, on which logs are supported in swinging them up onto the pile.  
 pinch, *n.* One of the logs laid against a log pile, up which logs are rolled.  
 pinch, dead, *n.* The pressure on a saw in the kerf which prevents movement.  
 pine straw, *n.* A severe pinch in which no movement of the saw is possible.  
 pitch, *n.* Dry pine needles.  
 pole, *n.* The resin or sap of certain evergreen trees.  
 pole-ax, *n.* The hammer surface of a pole-ax.  
 pole cat, *n.* A single-bitted ax with a hammer surface opposite the edge.  
 pulphook, *n.* A tie cutter. Also "tie peeler," "tie whacker."  
 pulpwood, *n.* A small steel hook used in handling pulpwood.  
 pulpwood ax, *n.* Logs used for making paper pulp, usually smaller logs up to a foot in diameter at the butt, of such trees as spruce, hemlock, southern pine, balsam, firs, cottonwood, and aspen.  
 pulpwood saw, *n.* An ax of the size commonly used in cutting pulpwood, weighing 2½ pounds with a 28-inch handle.  
 puncheon, *n.* A bucksaw with a bow-shaped steel frame, used in cutting pulpwood, usually 42 inches long.  
 punk, *n.* A split log used for flooring.  
 push, *n.* One who blows the horn or pulls the whistle signal.  
 pushing pole, *n.* The camp boss or foreman. Also "pusher," "bull," "uncle," "ramrod."  
 rag mansion, *n.* A pole used in felling trees with a saw, to start the fall.  
 ramrod, *n.* A tent.  
 The camp boss or foreman. Also "bull," "uncle," "push."

rick, *n.* A measure for wood, 8 feet long, 4 feet high, and of whatever width the wood is cut. See *CORD*.  
 ridge-runner, *n.* A mountaineer.  
 rive, *v.* To split boards, shakes, or clapboards.  
 river-hog, *n.* One who rides or birls logs in the water, and rafts them in booms. Also "boom-hog," "boom-pig," "boom-rat."  
 rosin-belly, *n.* A logger. Also "brush-rat," "Bunyan boy," "bush-whacker," "sawdust-savage."  
 salve-eater, *n.* A snuff chewer.  
 sawdust savage, *n.* A logger. Also "sawdust eater," "brush-rat," "Bunyan boy," "bush-whacker," "rosin-belly."  
 schoolmarm, *n.* A forked tree or tree with a double trunk.  
 set, *n.* The cutting thickness of a saw, determined by the amount of bend given the teeth.  
 shake, *n.* A thin board split from a log and used as a shingle. Also "clap-board."  
 shotgun camp, *n.* A camp in which the men work at top speed.  
 sidewinder, *n.* A tree knocked down by a tree that is being felled.  
 silver-tip, *n.* 1. An old man.  
 2. A blonde Swede.  
 sizzler, *n.* 1. The camp cook. Also "dough-mixer," "hash-burner," "kitchen mechanic," "stomach-robber," "mulligan mixer."  
 2. A stove.  
 skid, *n.* One of the logs on which logs are piled off the ground.  
 v. 1. To drag a log by one end. Also "snake."  
 2. To haul logs out of the woods by any means.  
 skid-road, *n.* 1. A road on which logs are skidded or hauled.  
 2. The part of the town frequented by loggers.  
 skidway, *n.* A platform of logs on which logs are piled.  
 slash, *n.* The branches and tops of trees trimmed off and discarded in logging. Also "lops."  
 slasher, *n.* A chopper.  
 smoke-eater, *n.* A forest-fire fighter.  
 snake, *v.* To drag logs at full length.  
 snipe, *v.* To round off the edges at the end of a log to facilitate skidding. Also "nose."  
 snoose, *n.* Snuff, particularly the type used for chewing. Also "Swedish conditioning powder."  
 snub, *v.* To stop the log from rolling, in birling, with one's calked boots.  
 springer, *n.* A bent limb or sapling that springs back straight when released.  
 spud, *n.* A tool for removing bark from logs.  
 squint-eye, *n.* One who sharpens saws. Usually "old squint-eye."  
 stem, *n.* The trunk of a tree.  
 stick, *n.* A log.

stomach-robber, <i>n.</i>	The camp cook. Also "dough-mixer," "hash burner," "kitchen mechanic," "mulligan-mixer," "sizzler."
strawberries, <i>n.</i>	Beans.
stump detective, <i>n.</i>	One who estimates the amount of waste in stumps and tree tops.
swamp, <i>v.</i>	1. To make a road in the woods for logging. 2. To clear out brush, stumps, etc. as in making a road.
swamp angel, <i>n.</i>	A swamp worker. Also "mud hen."
swamper, <i>n.</i>	One who swamps or makes roads.
Swede fiddle, <i>n.</i>	1. A crosscut saw. Also "misery whip," "brier." 2. A bow-saw.
Swedish conditioning powder, <i>n.</i>	Snuff used for chewing. Also "snoose."
Swedish saw, <i>n.</i>	A bucksaw with a bow-shaped steel frame.
swing, <i>v.</i>	To move a log by supporting it on an object near one end, so as to raise and swing the other end around.
three-quarter ax, <i>n.</i>	An ax weighing 2½ pounds, with a 28-inch handle. Also "pulp-wood ax," "boy's ax."
timber!	1. A warning given when a tree is about to fall. 2. Any warning or exhortation to be alert.
timber-carrier, <i>n.</i>	A tool for carrying logs, consisting of a pair of hooks hung in the middle of a wooden handle. Also "lug-hook," "come-along."
timber cruiser, <i>n.</i>	One who estimates the amount of timber in an area.
timber wolf, <i>n.</i>	A woodsman. Also "wood-tick."
top fire, <i>n.</i>	A fire in the tops or crowns of trees. Also "crown fire."
toothpick, <i>n.</i>	A small tree.
travois, <i>n.</i>	A skid-road.
turkey, <i>n.</i>	A canvas pack or bag in which a logger carries his belongings.
uncle, <i>n.</i>	The camp boss or foreman. Also "bull," "push," "ramrod."
undercut, <i>n.</i>	The notch cut in a tree to fell it in the desired direction.
walking bull, <i>n.</i>	A foreman who supervises several camps.
wanigan, <i>n.</i>	1. A houseboat used as a kitchen and messhall. 2. A temporary kitchen; a portable kitchen. 3. The logging camp store.
webfoot, <i>n.</i>	A boom-rat who works in a millpond.
whiskers, <i>n.</i>	The splinters on the end of a felled tree or log.
white-water bucko, <i>n.</i>	A good boom-rat or log-jockey.
widow-maker, <i>n.</i>	1. A branch which may strike one's head in walking under it. 2. A loose branch left hanging in a tree which may fall unexpectedly. Also "fool-killer." 3. A lodged tree which may fall unexpectedly.
wood butcher, <i>n.</i>	A carpenter.
wolf tree, <i>n.</i>	A large tree that robs small trees around it of light.
wood-tick, <i>n.</i>	A woodsman. Also "timber wolf."
wrench, <i>n.</i>	A log-wrench or cant-hook.