

IAC-14-A5.2.7

AN INDEPENDENT ASSESSMENT OF THE TECHNICAL FEASIBILITY OF THE
MARS ONE MISSION PLAN

Sydney Do

Massachusetts Institute of Technology, Cambridge, MA, United States, sydneydo@mit.edu

Koki Ho, Samuel Schreiner, Andrew Owens, Olivier de Weck

Massachusetts Institute of Technology, Cambridge, MA, United States

In mid-2012, the Mars One program was announced, aiming to build the first human settlement on the surface of Mars. Following a series of precursor missions to develop and deploy key technologies, the first crewed mission would depart Earth in 2024, sending four people on a one-way journey to the surface of Mars. Additional four-person crews would be sent to Mars at every subsequent launch opportunity to further support and expand the Martian colony. While this program has been received with great fanfare, very little has been published in the technical literature on this mission architecture. As the Mars One mission plan represents a dramatic departure from more conservative exploration approaches, there are many uncertainties in the mission design. The establishment of a colony on Mars will rely on in-situ resource utilization (ISRU) and life support technologies that are more capable than the current state of the art. Moreover, resupply logistics and sparing will play a large role in the proposed colony, though the magnitude and behavior of these two effects is not well understood. In light of this, we develop a Mars settlement analysis tool that integrates a habitat simulation with an ISRU sizing model and a sparing analysis. A logistics model is utilized to predict the required number of launchers and provide a preliminary estimate of a portion of the program cost. We leverage this tool to perform an independent assessment of the technical feasibility of the Mars One mission architecture. Our assessment revealed a number of insights into architecture decisions for establishing a colony on the Martian surface. If crops are used as the sole food source, they will produce unsafe oxygen levels in the habitat. Furthermore, the ISRU system mass estimate is 8% of the mass of the resources it would produce over a two year period. That being said, the ISRU technology required to produce nitrogen, oxygen, and water on the surface of Mars is at a relatively low Technology Readiness Level (TRL), so such findings are preliminary at best. A spare parts analysis revealed that spare parts quickly come to dominate resupply mass as the settlement grows: after 130 months on the Martian surface, spare parts compose 62% of the mass brought from Earth to the Martian surface. The space logistics analysis revealed that, for the best scenario considered, establishing the first crew for a Mars settlement will require approximately 15 Falcon Heavy launchers and require \$4.5 billion in funding, and these numbers will grow with additional crews. It is important to note that these numbers are derived only when considering the launch of life support and ISRU systems with spare parts. To capture a more realistic estimate of mission cost, future work should consider development and operations costs, as well as the integration of other key mission elements, such as communications and power systems. Technology development towards improving the reliability of life support systems, the TRL of ISRU systems, and the capability of Mars in-situ manufacturing will have a significant impact on reducing the mass and cost of Mars settlement architectures.

I. INTRODUCTION

In recent years a number of new mission architectures for Mars exploration have emerged, many of which propose sustainable long-term settlements on the surface. These mission plans are a drastic departure from the more traditional concept of initial sortie missions followed by later long-term missions. The logistics supply demands of a long-term colony are not well understood, especially when considering the spare parts that must be supplied to ensure its reliable operation. Furthermore, In-Situ Resource Utilization (ISRU) is often included in such mission plans as a cornerstone to sustainability. Such technology is still at a relatively low technology readiness level (TRL) and as such the mass, volume, and power required by these

systems are quite uncertain. This uncertainty is compounded by a lack of operational data to produce reliability numbers for a spares analysis.

We present the development of an architecture analysis tool for long-term settlements on the Martian surface. This tool includes a functional Environmental Control and Life Support (ECLS) system simulation of a habitat on the surface of Mars, an ISRU sizing model, an analysis of the required number of spares, and a launch logistics model. The ECLS functional simulation is used to provide estimates of atmospheric leakage, Extravehicular Activity (EVA) losses, plant growth water usage, and other resource requirements for an ISRU sizing model. The ISRU model parametrically designs a soil processing module for extracting water

from the Martian soil and scales an atmospheric processing module to separate Nitrogen and Argon from the Martian atmosphere. A detailed components list, including 117 unique items from both the ECLS and ISRU systems, is compiled to provide a partial estimate of the mass of the settlement. Furthermore, a sparing analysis using the Mean Time Between Failures (MTBF) for each component is conducted on both the ISRU and ECLS systems. This sparing analysis determines the required number of spare parts to provide a probability greater than 0.99 that enough spares will be available to execute all required repairs during the time between resupply missions. The entire manifest of ECLS and ISRU components, as well as the required number of spares, is compiled and fed into a space logistics analysis tool that determines the number of launches required to deliver such a mass to the Martian surface. This logistics tool also generates an estimate of the production, launch, and logistics cost associated with supporting a settlement on Mars.

This Mars settlement architecture analysis tool is leveraged to provide an independent assessment of the Mars One mission architecture. Major drivers of system mass and cost are identified and suggestions for reducing these numbers are presented.

Section II provides a background on the Mars One architecture. Section III.I describes the ECLS simulations and highlights key design points for a sustainable habitat. Section III.II provides details on the ISRU system model and note some areas of uncertainty and future research and development. Section III.III describes the spares analysis procedure, noting the differences in design paradigms between current state-of-the-art systems and the proposed mission strategy and determining the required number of spares. Section III.IV presents the both the launch schedule as well as the associated cost estimates from the logistics analysis. Section IV presents the results from integrated model. Conclusions are presented in Section V, with a focus on system mass and cost drivers and possible avenues for reduction of the aforementioned quantities.

II. BACKGROUND

This section provides a brief summary of the Mars One mission plan and discusses the implications of some of the underlying assumptions on our analysis. Because no information regarding the Mars One mission was found in the literature, mission architecture details are primarily derived from the Mars One website¹, as well as the request for proposals and the proposal information package for the 2018 Mars Lander payload².

II.I Mars One Background

A distinguishing feature of the Mars One architecture is the philosophy of sending people on a

one-way journey to Mars. To enable this, the Mars One mission plan consists of a series of precursor missions to demonstrate and deploy key technologies, followed by one-way crewed missions to Mars at every subsequent launch opportunity. These missions are accomplished with a set of common mission elements, summarized in Table 1.

The campaign commences with a precursor mission launching in 2018, involving a Mars surface lander based on the design of the NASA Phoenix Lander. The goal of this mission is to test and demonstrate a series of key technologies required to sustain a human settlement on the Martian surface. These include thin-film solar arrays and an oven to extract water from Martian regolith. In addition to the lander, a Mars orbiting communications satellite will also be launched on this mission to support both the precursor, and subsequent missions¹.

Pending the success of this first mission, a follow up mission is planned for launch in 2020, transporting a multi-purpose rover to a predetermined site, likely in the northern hemisphere at approximately 45 degrees latitude². The rover will survey the region for a suitable settlement site and upon its selection, will prepare the site for the subsequent arrival of the habitation modules.

On the following launch opportunity in 2022, six modified SpaceX Dragon³ spacecraft will be launched and upon arrival in 2023, will be connected together using the previously deployed rover to form a continuous habitat. These modules come in three variants, each of which is designated for a different function. Specifically, they are:

- **Living Units**, which each contain a 500m³ inflatable structure, an airlock for crew extravehicular activity (EVA), and the wet areas of the habitat, such as the waste and hygiene compartment
- **Life Support Units**, which each contain air revitalization, water processing and waste management technologies and stores. In addition, these units contain the ISRU system, as well as the thin-film solar arrays that will supply power to the habitat
- **Cargo Units**, which store supplies and spare equipment for the habitat

For the purposes of redundancy, each Mars One habitat contains two copies of each unit. More detail regarding the Mars One habitation layout is described in Section III.I. In addition, a separate human lander unit also based on the Dragon module is used to deliver the crew to the surface.

After the emplacement of these habitation units, the thin-film solar arrays are deployed along with the ISRU system. Over the subsequent 500 day period, the rover delivers regolith to the ISRU oven, where it is baked to extract water. A portion of this water is then

electrolyzed to generate oxygen. At the same time, an atmospheric processor extracts and stores nitrogen from the Martian atmosphere. It is expected that by the time the first crew departs Earth, the ISRU system would have produced 3000L of water, 120kg of stored oxygen, and enough oxygen and nitrogen to support a breathable atmosphere of 0.7bar within the habitat⁴.

This first crew will nominally depart Earth in 2024 in a Mars Transit Vehicle (MTV) that will primarily employ an open-loop life support system. Within the same launch window, another six habitation units will be sent to provide the equipment and habitation required for a second four-person crew.

After landing in 2025, the first crew will enter the habitat, activate the food production system, and integrate the six habitation units that were launched with them into the initial habitation system. These newly added units will support a second four-person crew, who will depart Earth in 2026, along with another set of equipment to support the subsequent third crew.

This cycle of sending four person crews along with the habitation equipment to support follow-on four-person crews continues every 26 months, thereby allowing the settlement to gradually expand over time¹.

II.II Analysis Focus

In this paper, we apply our Mars settlement architecture tool to the habitat pre-deployment and crewed portions of the Mars One mission profile. We treat the period between the pre-deployment of a complete surface habitat (consisting of 6 SpaceX Dragon capsules) and 26 months after the crew arrives (one launch cycle) as a repeating unit of resource demands over time. This allows us to quantify the resource demands of the settlement as it expands beyond the arrival of the first four-person crew.

The Mars One mission plan is built upon a philosophy of maximizing local resource use and exploiting existing technology⁵. The claim that currently available technology is capable of supporting the mission has often been used as an argument to justify the mission’s feasibility. This position is evident with official statements such as:

“No new major developments or inventions are needed to make the mission plan a reality. Each stage of Mars One mission plan employs existing, validated and available technology.”⁵





Mission Phase	Timeframe	Elements deployed	Image
Precursor	2018	Technology demonstration lander on Martian surface and communications satellite deployment in Mars orbit (not shown)	
Pre-deployment	2020	Multipurpose rover used for site prospecting and clearing, habitat set up, crew transportation, and regolith collection for local processing	
Pre-deployment	2022-2023	Crew habitat: this consists of three variants of a core unit based on the SpaceX Dragon ³ module, as well as a 500m ³ inflatable unit. The initial habitat will consist of six Dragon modules connected with two inflatable units. Refer to Section III.I for additional details. (Image from Business Insider ⁶)	
First Crew Transit	2024	Mars Transit Vehicle: this consists of a Transit Habitat and a Mars Lander and functions as the means of crew transport from Earth to the Martian surface	
Expansion	2025 onwards	Additional crew habitat units are launched during the same launch window as every crew launch. These are integrated into the Mars One habitat, enabling the infrastructure to grow with its increasing population	

Table 1: The Mars One mission architecture for establishing a settlement on the surface of Mars¹

While there is some reference to existing technology within the Mars One mission plan, a survey of the current state of the art indicates that many of the technologies that would likely be employed on such a mission are not currently ready for deployment. While some relevant technologies and operational approaches have had significant use in spaceflight, they were not originally developed for the Martian environment, and thus no relevant data for a Martian mission is available. Conversely, some other relevant technologies are still in the early stages of development, and thus little performance and sizing data is available for them. Specific examples of this include the fact that:

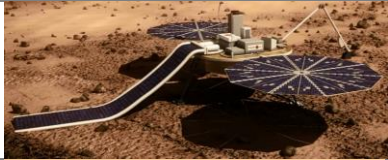
- ISRU technology is at a relatively low TRL, with most operational experience coming from field analogue tests conducted by NASA between 2008 and 2012 in Mauna Kea, Hawaii⁷. As a result of this, there is a high uncertainty in the reliability and size of ISRU systems.
- Unofficial sources have stated that the Mars One habitat will be based on a 5 meter diameter, 25m³ variant of the SpaceX Dragon capsule⁸. The current Dragon⁹ capsule has a diameter of 3.6 meters and a pressurized volume of 11m³ and there has been no announcement from SpaceX regarding the development of a scaled-up version.
- Plant growth for space applications is still in the early stages of development. Only a handful of plant experiments have been flown in space, all of which have been deployed at a small scale. As a result, there is much uncertainty in the ultimate sizing of the crop system for flight systems.
- The current operational paradigm for the International Space Station (ISS) relies on the availability of regular resupply from the ground. This has in turn affected its system design and operations. No operational experience has been gained for long-duration human spaceflight missions beyond low Earth orbit^{10,11}

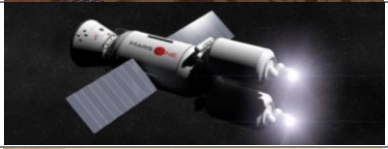
As a result of the lack of relevant data and operational experience, several assumptions have had to be made to analyse the Mars One mission plan. These have been made based on extrapolations of the current state of the art, and on the fundamental design philosophies discussed earlier.

Finally, it should be noted that our analysis focuses exclusively on the technical feasibility of the habitation, life support, in-situ resource utilization, and space transportation technologies required for this mission. These systems compose only a subset of the entire architecture. There are many other areas that need to be investigated in detail in order to mature the Mars One mission architecture into an executable plan. These

include the Mars entry, descent, and landing strategy, the power system architecture, and the surface-to-orbit communications strategy, to name a few. These areas each impose their own requirements on the operations and logistics architecture of the mission and must be considered in concert with those analysed here.

III. METHODOLOGY AND SUBSYSTEM RESULTS

To evaluate the feasibility of the Mars One mission plan, we have developed an integrated simulation environment that captures both the functional performance and the associated sizing of selected technologies. Figure 1 depicts a high-level block diagram of the simulation environment.

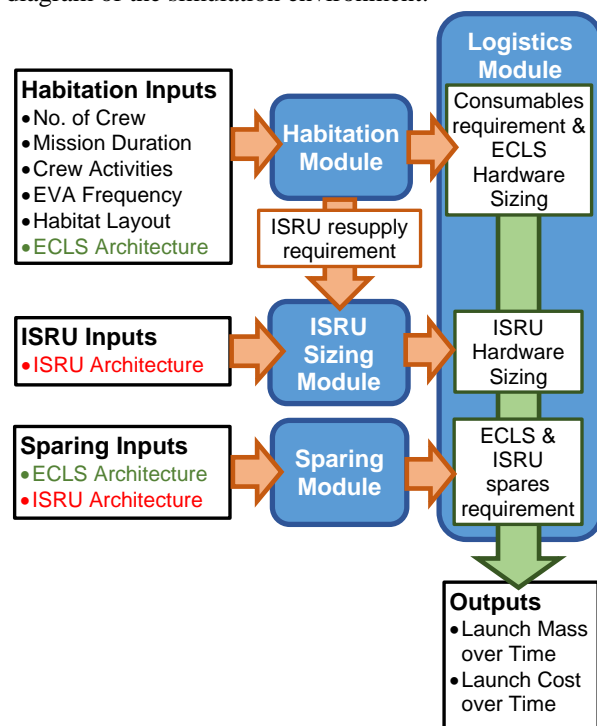

Fig. 1: High level block diagram of simulation environment

As can be seen in the above figure, the simulation environment consists of four modules: a Habitation model, an ISRU Sizing Model, a Sparing Model, and a Space Logistics Model. The analysis commences with a selection of input values to the habitation, ISRU, and sparing models. The habitation model takes in key mission parameters as its inputs, and outputs the consumables requirement and the sizing for the ECLS hardware used. Additionally, the habitation model feeds an ISRU resupply requirement to the ISRU sizing model, which combines this information with the selected ISRU architecture to predict the mass and volume of the required ISRU hardware. In parallel, the

Sparing Model takes information regarding the selected ECLS and ISRU architectures and outputs the number and type of spares required for both systems. Finally, the Space Logistics model receives all of the information outputted by the three pre-processing models to predict the launch mass and launch cost over time.

In the following sections, the implementation and initial results obtained from each of these four modules is described in greater detail.

III.I Habitation Module

The Habitation Module is the core functional model within the integrated simulation environment. In addition to predicting requirements for consumables, the module identifies failure modes that occur as a result of depleted resources and unanticipated control interactions. Based on the BioSim¹² dynamic ECLS modeling environment developed in the early 2000s at NASA Johnson Space Center, this is accomplished by propagating the state of the resource stores and the crew health over time. This information can then be used to inform the habitat design and operations. Figure 2 depicts a high level summary of the data flow within the habitation module.

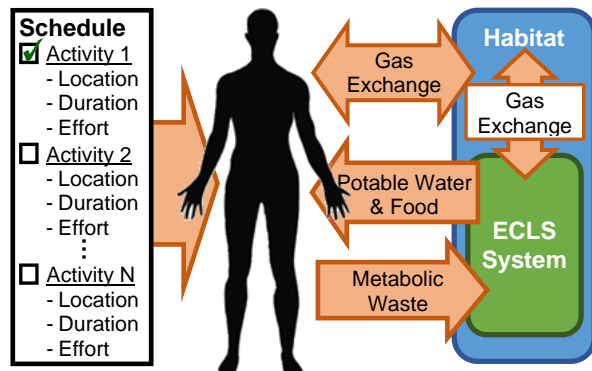

Fig. 2: Data Flow within the Habitation Module

As can be seen in Figure 2, one of the first inputs into the Habitation Module is the assignment of a schedule to each crewmember. The schedule consists of a set of activities, each with its own location, duration, and effort level. As the simulation propagates forward in time, each crewmember progresses through their own schedule, expending varying levels of effort, which in turn varies their resource consumption and metabolic exchange rates with the habitat. Moreover, in the case of the habitat consisting of multiple modules, activities can be allocated to individual locations, thus allowing the crew to move throughout the habitat as they work through their activity list. Through the introduction of varying effort levels and activity locations, transient behavior is introduced into the habitation simulation environment.

Pre-selected Environmental Control and Life Support (ECLS) technologies modeled within this module act to smoothen this transient behavior by managing resource consumption and production to the levels appropriate to maintaining crew health. These ECLS technologies are allocated to different modules within the habitat, and handle varying crew metabolic waste loads as they move through a given habitat module.

Once running, one of two conditions terminates the simulation. The first is if one of the pre-specified failure conditions is met, while the second occurs when the simulation uneventfully reaches the end of the specified simulation time horizon. In the former case, a failure occurs due to the depletion of one or more resource stores, which in turn leads to insufficient resources available for crew consumption. Actions taken to rectify the failure for subsequent simulation runs depend on how far into the simulation time horizon the failure occurs. In the case that the failure occurs early in the simulation, an architectural change for the ECLS system is typically required. Conversely, failures that occur later in the simulation time horizon are typically rectified by introducing some source of additional resources. These can come from either an ISRU technology, from a logistics resupply source, or by increasing the initial amount of resource carried.

The failure conditions employed within the habitation module are summarized in Table 2.

Failure Condition	Model Implementation
Crew starvation	Crew caloric consumption requirement is greater than calories available within food store
Crew dehydration	Crew water requirement is greater than potable water available within potable water store
Crew hypoxia	Partial pressure of oxygen within crew environment is less than 15.168kPa ¹³
Crew CO ₂ poisoning	Partial pressure of carbon dioxide within crew environment is greater than 0.482kPa (0.07psi) ¹³
Cabin underpressure condition	Total cabin pressure is less than 20.7kPa (3psi) ¹³
High Fire Risk	Molar fraction of oxygen within crew environment exceeds 30% ¹⁴

Table 2: Failure conditions employed within the Habitation Module

Mars One Habitat Model Set Up and Assumptions

With the basic habitation simulation architecture established, a virtual model of the nominal Mars One habitat can be set up to evaluate its functional feasibility. Here, we focus on modeling the first Mars

One habitat over the period spanning from the time of first arrival of the first crew through to the time at which the second crew arrives on the Martian surface. This equates to the maximum time that the habitat must sustain a crew between resupply opportunities from Earth. It is assumed that any habitation architecture capable of sustaining a four-person crew over this period can continue to sustain future four-person crews given that it is adequately resupplied at the earliest resupply opportunity. Thus, such a habitation architecture can be used as a common repeating functional unit that is deployed with every expansion mission beyond the arrival of the first crew.

As shown in Figure 1, we use the results of our analysis to inform the requirements on the ISRU system during both the habitat pre-deployment and crewed phases of the campaign. This information, along with the ECLS architecture information input into the habitation module is used with the Sparing Module to determine the total mass and volume required to support the campaign.

To perform the habitation analysis, several assumptions were made to enable the simulation of the Mars One habitat. These are detailed in Appendix A. When insufficient data was available for a given parameter, the most reliable available data was used. For instance, habitat and spacesuit atmospheres were taken from recommendations of the NASA Exploration Atmospheres Working Group (EAWG) that was formed to evaluate vehicle atmosphere options for the now-cancelled Constellation Program¹⁴. Similarly, other parameters, such as leakage rates, were taken from NASA's Baseline Values and Assumptions Document (BVAD)¹⁵.

In addition to the values listed in Appendix A, other assumptions are required for values that affect the dynamic response of the simulation model. These include assumptions related to the crew composition and schedule, the ECLS technologies employed, the allocation of equipment and technologies within the habitat, and the selection of crops grown by the Biomass Production System (BPS). These assumptions are elaborated as follows:

Crew Composition: The Habitation Module uses the model developed by Goudarzi and Ting¹⁶, to determine crew resource demands based on their activity level and their basal metabolic rate, which is in turn driven by their gender, age, and body mass. For the purposes of this analysis, we assume a four person crew consisting of two males and two females, all aged 35 years old. One of the males has a mass of 72kg while the other has a mass of 75kg. Both females have a mass of 55kg. While these values were arbitrarily chosen, they are typical of the astronaut population¹⁷.

Crew Schedule: The assumed crew schedule is based on the typical schedule of a current ISS crewmember¹⁸. For each crewmember, 8 hours of sleep and 2 hours of exercise are budgeted per day. On EVA days, 8 hours of EVA are scheduled throughout the middle of the day, with the remainder allocated to Intravehicular Activities (IVA). IVA can include activities such as performing science experiments, preparing meals, or harvesting and replanting crops. For the purposes of this simulation, all non-EVA, sleep and exercise activities are classified as IVA, where they are assumed to require the same level of crew energy expenditure. As a result, on non-EVA days, crewmembers are assigned with IVA tasks during their non-exercising waking hours.

ECLS Technologies: Based on the claim that the Mars One life support units will “*be very similar to those units which are fully functional on-board the International Space Station*”¹⁹, we will assume that technologies with functions similar to the those onboard the International Space Station (ISS) United States Orbital Segment (USOS) will be used. The one exception to this is the food system, which as listed in Appendix A, will come predominantly from locally grown crops.

It should be clarified that the ECLS technologies developed for the ISS were specifically developed to perform in microgravity. The introduction of a partial gravity environment will inevitably lead to different ECLS technologies. These will likely be less complex than those onboard the ISS due to the simplification in chemical separations that a gravity environment affords. Regardless, the general architecture will be the same as that on the ISS, based on NASA's current baseline Mars surface habitat ECLS architecture.²⁰

Appendix B summarizes the ECLS technologies assumed to be implemented, while Figure 3 depicts the ECLS system topology. In this figure, white elements represent those technologies currently deployed in some version on the ISS, while green elements represent the introduction of some form of BPS. Similarly, orange elements represent ISRU technologies. We observe from this figure that the baseline Mars One ECLS architecture is essentially an augmented version of the ISS ECLS architecture. Because there is currently no flight experience with ECLS systems incorporating the introduction of these new systems, we have had to make first order engineering estimates on their performance and sizing for this analysis. The BPS sizing process is described later in this section, while Section III-II discusses the approach taken to size the ISRU system.

ECLS Technology Location Allocation: An important element of dynamically modeling ECLS systems is the allocation of technologies to physical locations within the habitat. This introduces a spatial

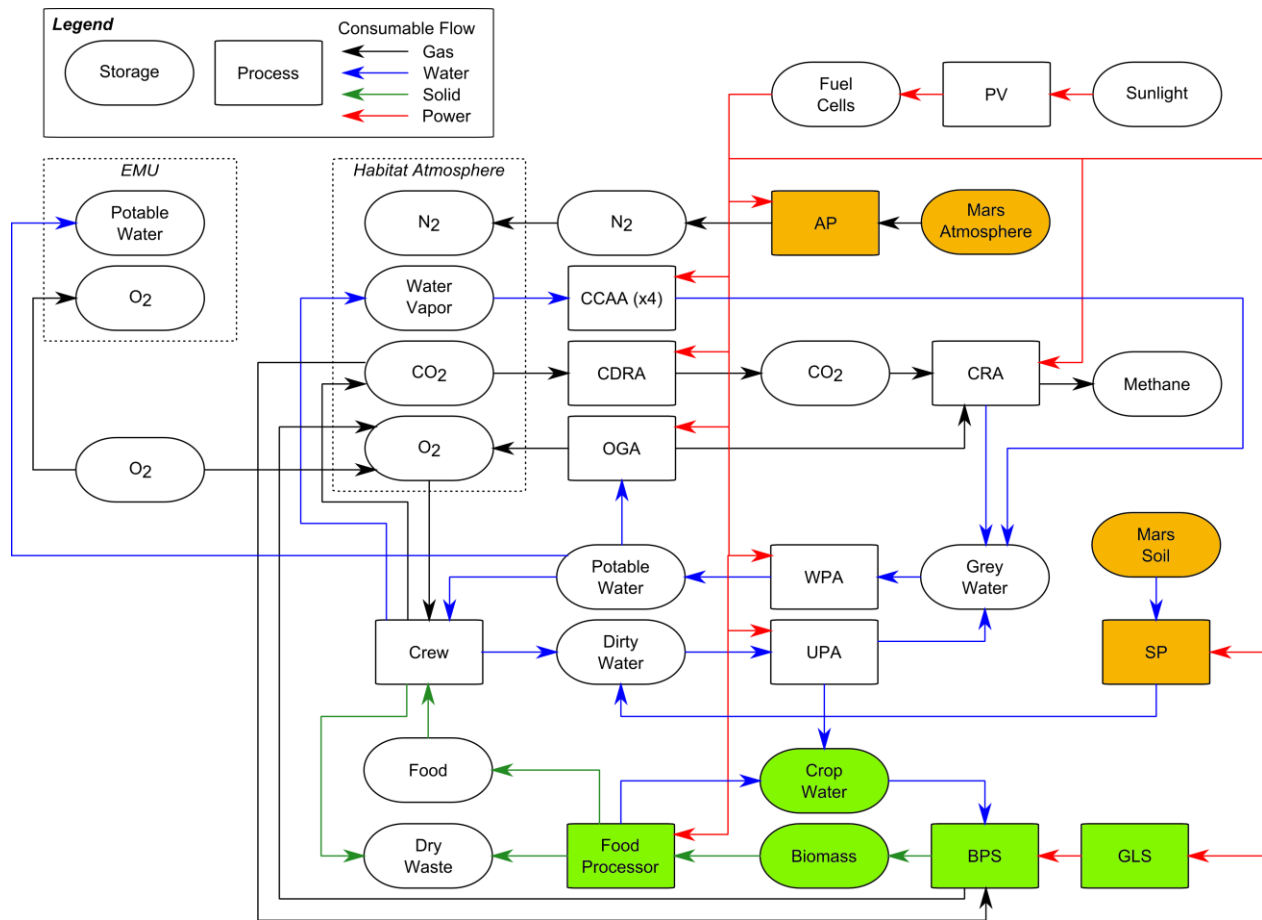

Fig. 3: Baseline Mars One ECLS and ISRU system functional topology

dimension into the simulation environment, which in turn allows for the impact of local ECLS resource exchanges on global habitat sustainability to be modeled. For the purposes of this analysis, we have used the functional allocation of technologies on the various ISS modules as a reference for allocating physical locations for the Mars One ECLS technologies. Appendix C summarizes the heuristics derived to guide this process, while Figure 4 depicts the ECLS technology location allocation assumed for the baseline Mars One habitat. Note that in this figure, only half the habitat is shown as it is assumed that the other half is an exact copy. This assumption is supported by claims that the combination of one Living Unit and one Life Support Unit is capable of sustaining a four-person crew²¹.

Furthermore, while most of the equipment allocations were based on descriptions published on the Mars One webpage, the general layout of the inflatable was inferred from images rendered by the Mars One foundation. Figure 5 presents an example of one of these images. Note here that the BPS shares the same volume and atmosphere as that of the rest of the Inflatable.

Finally, to simulate the impacts of crew resource consumption in different locations throughout the habitat, crew activities were also allocated to locations. Thus as the crew works through their schedules, they move through the various habitation modules, exchanging resources with local ECLS technologies. This implementation allows for the propagation of local resource deficiencies throughout the habitat to be observed.

Biomass Production System Crop Selection: The lack of BPS flight experience introduces significant uncertainty to the integrated behavior of the habitat. Such a system can demand significant resources, depending on the number and type of crops grown. This quantity of crops ultimately depends on the proportion of the crew diet sourced from plant growth, as well as the daily caloric demand of the crew, which is in turn driven by each crewmember's gender, age, weight, and activity level.

For the purposes of this analysis, we use the approach described in Jones²² to determine the crew daily macronutrient demand, and introduce our own optimization scheme to determine the appropriate crop selection to meet this demand.

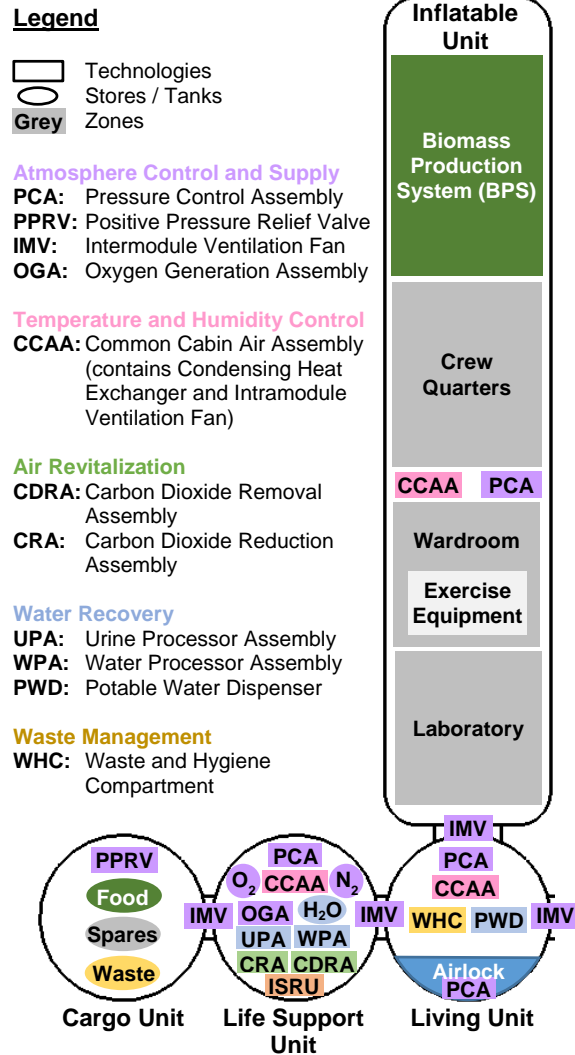

Fig. 4: Assumed ECLS Technology Location Allocation



Fig 5: Artistic Rendering of the Mars One Inflatable Unit²³

Here, we base all of our crop growth predictions on the Modified Energy Cascade (MEC) models described in the NASA Baseline Values and Assumptions Document¹⁵. These models were originally developed by Jones and Cavazonni²⁴ to predict plant growth rates as a function of atmospheric CO₂ concentration, humidity level and local lighting level. Over time, plant transpiration and oxygen production models were incorporated into the MEC models²⁵. These are also incorporated into our crop models to predict crop oxygen and water vapor output. Moreover, our crop

models have been validated with results published in the literature²⁶, as shown in Figure 6.

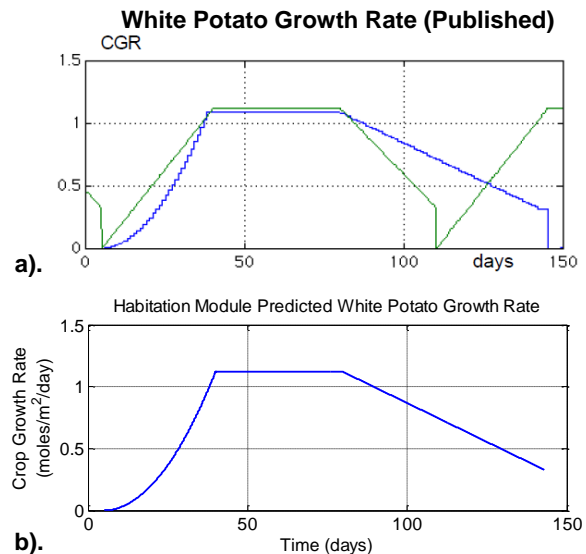

Fig 6: Comparison between published (top) and simulated (bottom) white potato growth rates

The main limitation of the MEC models is the limited number of crops that it can model. This is due to the lack of experimental data available to capture plant growth coefficients used by the MEC model. As a consequence, our crop selection is also limited to the same set of MEC-modeled crops. These crops are: dry bean, lettuce, peanut, rice, soybean, sweet potato, tomato, white potato, and wheat.

To determine the required crop selection, the average daily crewmember caloric demand was first determined by running the habitation model with the crew composition and crew schedules described earlier. From this, it was found that the average daily caloric demand of each Mars One crewmember is 3040.1 Calories*. According to the Mars One foundation, 100% of these calories must be provided every day by the biomass production system (see Appendix A).

For a typical diet consisting of a caloric macronutrient makeup of 68% carbohydrates, 12% protein, and 20% fat²², this equates to a daily biomass production requirement of 2067.2 grams of carbohydrates, 364.8 grams of protein, and 270.2 grams of fat for the four Mars One crewmembers.

Using these values, the required crop growth areas were determined by formulating and solving the following multi-objective optimization problem:

*Note that in this paper we employ the common use of the term Calories. One common Calorie equals one scientific kilocalorie, which equals to 4.184 kilojoules

$$\min w_1 \sum_{i=1}^{i=9} x_i + w_2 \sigma(\mathbf{x}) \quad [1.1]$$

$$\text{s.t.} \quad \sum_{i=1}^{i=9} c_i r_i x_i \geq 2067.2 \quad [1.2]$$

$$\sum_{i=1}^{i=9} p_i r_i x_i \geq 364.8 \quad [1.3]$$

$$\sum_{i=1}^{i=9} f_i r_i x_i \geq 270.2 \quad [1.4]$$

$$x_i \geq 0 \quad \text{for } i=1, \dots, 9 \quad [1.5]$$

Where \mathbf{x} is a nine element vector representing the growth area allocation for each of the nine candidate crops, \mathbf{c} , \mathbf{p} , and \mathbf{f} correspond to vectors representing carbohydrate, protein, and fat fractions of dry mass of the nine candidate crops, and \mathbf{r} corresponds to a vector of static growth rates. These values are listed in Appendix D.

We can observe from the above formulation that the objective function for this optimization problem is the weighted sum of the total allocated crop growth area, and the standard deviation of the individual areas of each of the crops. The first component of this objective function is based on the goal of minimizing biomass production system mass and volume, since these parameters typically grow with increasing crop growth area¹⁵. Conversely, the second component of the objective function corresponds to maximizing the variety of crops grown. Reducing the standard deviation across the set of selected areas effectively drives the optimizer towards introducing more crop species into the solution. Finally, the constraints imposed in this optimization problem ensure that the daily crew requirement for carbohydrates, proteins, and fats is met by the biomass production system.

To solve this optimization problem, differing values for the weighting factors w_1 and w_2 were applied to the objective function and a non-linear constrained optimization solver was employed. Table 3 summarizes the results obtained for different weighting value combinations.

From this table, we can observe that optimizing just for the crop growth area (Option 1), results in a total growth area requirement of 183.7m² - a value much greater than the 50m² claimed by the Mars One foundation. With this crop selection option, the crew would only survive on peanuts and wheat.

As we increase the weighting of the second component of the objective function, we move across Table 3 from left to right, causing the optimizer to gradually introduce more variety into the crew diet. This increase in variety comes at the cost of increased growth area. Moreover, we observe this variety being added in a sequential manner, indicating that there is a priority towards selecting plants that have both a high growth rate and a large nutrient content. Peanut and wheat crops

are always included in the crop mix because peanuts have the highest fat content of all the crop options, while wheat has a high carbohydrate content.

Crop	Option 1 w ₁ =1, w ₂ =0	Option 2 w ₁ =1, w ₂ =1	Option 3 w ₁ =1, w ₂ =1.5	Option 4 w ₁ =1, w ₂ =2	Option 5 w ₁ =1, w ₂ =2.3
Dry Bean					
Lettuce			11.6	22.7	26.1
Peanut	97.4	95.5	79.1	72.1	69.9
Rice					
Soybean		2.72	24.1	31.9	34.8
Sweet Potato					1.65
Tomato					
Wheat	86.3	86.1	77.8	70.9	67.5
White Potato					
Total Growth Area	183.7	184.3	192.6	197.6	199.9

Table 3: Optimized growth areas for various objective function weightings

Given that the crop selection will significantly influence the wellbeing of the crew for the entirety of their lives after reaching Mars, we opt for crop variety over minimizing growth area and select Option 5 of Table 3 for this analysis. While the 200m³ area required for this crop selection is four times larger than that originally stated by the Mars One Foundation, a computer aided design analysis indicates that it is still possible to fit this into a portion of the Inflatable unit if a high density packing scheme is employed, such as that originally planned for NASA’s BIO-Plex²⁷ - a proposed integrated habitation-BPS test facility that was developed throughout late 1990s, but never operated.

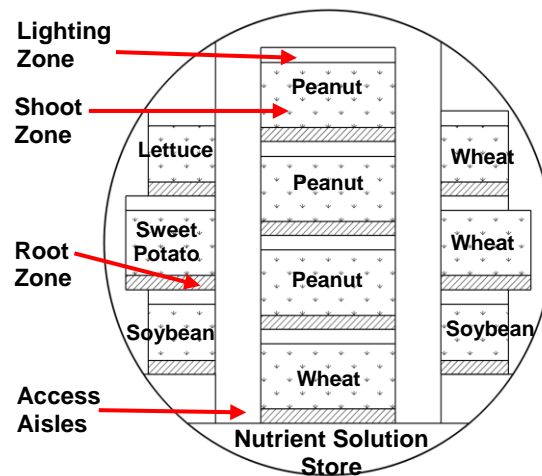

Fig. 7: Potential shelf layout for the selected crop growth areas

Figure 7 shows what the Mars One BPS might look like, based on the BIO-Plex²⁷ architecture. The system primarily consists of densely packed plant shelves, each with their own dedicated lighting system and hydroponic root zone. The root zones contain a nutrient solution that feeds the crops and is supplied by a large tank installed into the floor of the chamber. It was found that this particular BPS requires about 40% of the pressurized volume of the Inflatable Unit. We assume the use of LED lights in the Growth Lighting System (GLS) to minimize power use, and assume that it will be similar to the Heliospectra L4A Series growth light²⁸; a current state-of-the-art commercially available option. 875 LED units are required to provide full coverage of the 200m² growth area. Moreover, while the BIO-Plex was designed with a dedicated chamber for its BPS, the baseline Mars One BPS shares space and atmosphere with the crew inside each Inflatable Unit (see Figures 4 and 5). We investigate the impacts of this design decision in the next section.

Preliminary Habitat Modelling Results and Analysis

In this section, we present the results obtained from simulating the Mars One habitat with the Habitation Module using the assumed values presented in the previous section. Following an initial analysis of the baseline habitat configuration, we discuss and evaluate alternative habitation and ECLS system architectures. Note that as mentioned in Section III-I habitation simulations are first run without ISRU to determine the time at first failure. The subsequent architectural modification made is dependent on how far into the simulation time horizon this occurs.

Baseline Mars One Habitat Architecture: A first simulation of the baseline Mars One habitat indicated that with no ISRU-derived resources, the first crew fatality would occur approximately 68 days into the mission. This would be a result of suffocation from too low an oxygen partial pressure within the environment, as depicted in Figure 8.

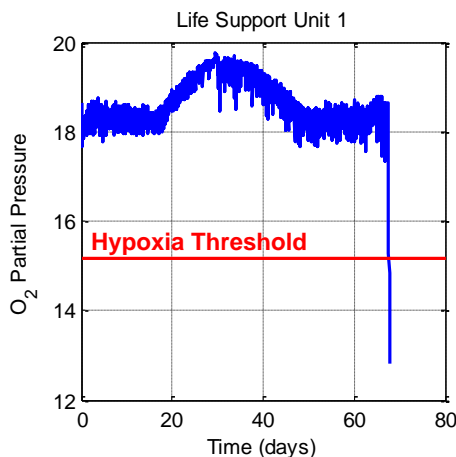

Fig. 8: Life Support Unit O2 Partial Pressure

At the same time, the habitat would be put into a state of high fire risk due to the oxygen molar fraction exceeding the 30% safety threshold, as indicated in Figure 9.

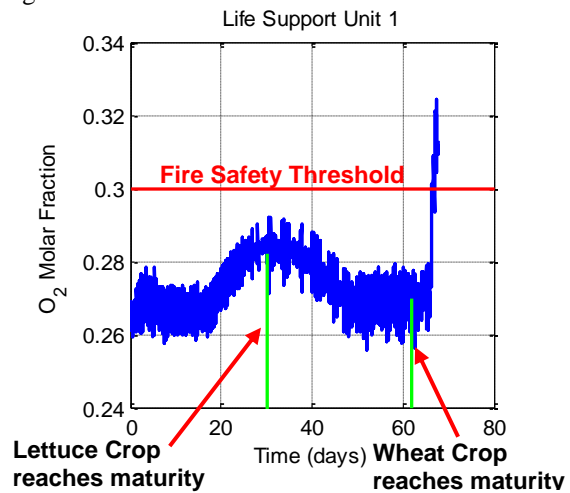

Fig. 9: Life Support Unit O2 Molar Fraction

Further investigation revealed that this non-intuitive result is primarily caused by the plants producing excessive oxygen, increasing oxygen partial pressure to outside their partial pressure control box, and causing the pressure control assemblies to vent air. Because the PCAs are not able to selectively vent a gas species, the oxygen molar fraction remains the same after venting, while the total atmospheric pressure reduces. Nitrogen is then selectively introduced into the environment to bring down the oxygen molar fraction. Over many cycles of air venting and nitrogen being introduced for oxygen molar fraction control, the nitrogen tank empties on day 66 of the mission (see Figure 10).

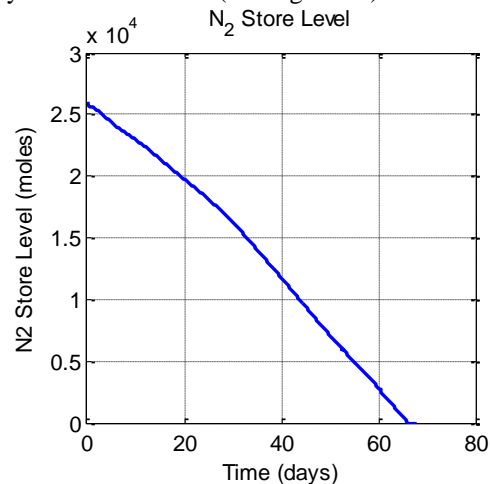

Fig. 10: N2 Store Level for the nominal Mars One habitat case

When this occurs, the continually increasing oxygen production by the plants increases the oxygen molar fraction within the habitat beyond the fire safety

threshold. At the same time, because nitrogen is no longer available to make up for module leakage, the habitat total pressure drops. The result is the simultaneous decreasing of oxygen partial pressure and increasing oxygen molar fraction.

Further analysis indicated that the oxygen production of the plants in fact increases as crops reach maturity. In this simulation case, all crops were grown in batch mode, with lettuce being the first to reach maturity at 30 days into the mission, followed by wheat, which reaches maturity at day 62. Figure 9 depicts the increase in oxygen molar fraction that occurs shortly after these mission days.

Moreover, supplying all food by growing plants in the same environment as the crew was found to increase the habitat relative humidity level towards 100%, beyond a comfortable limit for the crew¹³. At the same time, it was found that the 200m² of plants required significant hardware for lighting, and consumed up to 150L of water per hour, a quantity significantly higher than that able to be managed by the nominal water recovery and management system. As a result, a separate crop water system was implemented, as shown in Figure 12.

Mars One Habitat Architectural Options: The early system failures observed in the previous section prompted the development of two alternative habitat architectures for further study. These represent the

extremes of the range of food supply options. Specifically, they are to size a habitat that:

- Is supplied with food that is entire carried along from Earth. This is in-line with the current ISS food system
- Grows 100% of the required food locally, using a separate enclosed plant chamber to decouple the variations in atmospheric composition generated by the plants to those of the crew

In the following sections, each of these cases is analyzed in further detail to determine the ISRU requirements for both the habitat pre-deployment and crewed phases of the Mars One mission.

Habitat Option A – All Food is Carried Along

Figure 11 depicts the ECLS architecture for a habitat option that contains food entirely supplied from Earth.

During the pre-deployment phase, the ISRU system is tasked with generating sufficient oxygen and nitrogen to inflate both Inflatable Units to the target atmospheric pressure and composition, while at the same time overcoming the gas leakage rate inherent to the habitat. In addition, the ISRU is required to fill all potable water, nitrogen and oxygen tanks. Table 4 shows the ISRU system requirements for the 500 day pre-deployment¹⁹ phase of the mission that were calculated based on these criteria.

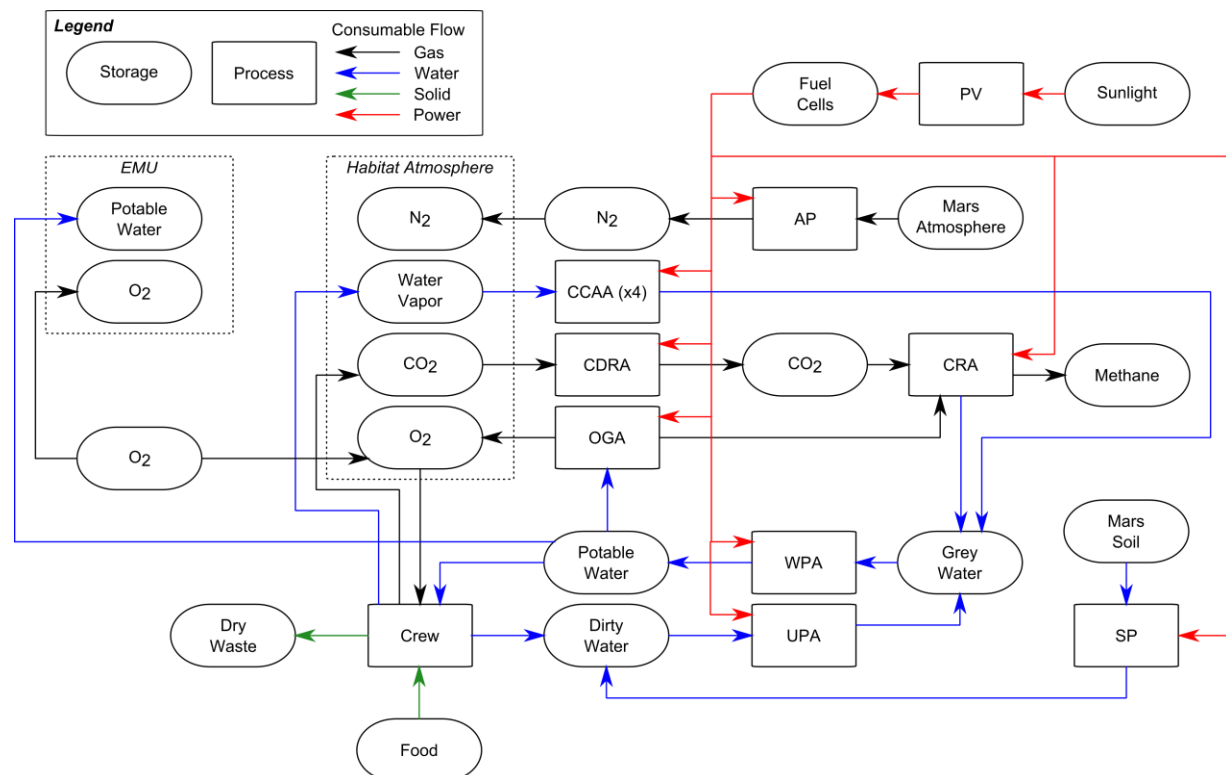

Fig. 11: Functional Flow Block Diagram for the No Plant Growth Habitation Case

ISRU Resource Requirement	Value
H2O (Liters/day)	6
O2 (moles/day)	24.6
N2 (moles/day)	68.2

Table 4: ISRU Requirements for the Predeployment Phase of the No Plant Case

To determine the ISRU requirements during the crewed phase, the habitat was simulated over a 26 month time horizon to determine any resource deficiencies. Because this architecture is very similar to that of the ISS, similar resource makeup requirements were observed. Specifically, makeup resources were required for:

- Oxygen, primarily due to use for the large number of EVAs performed
- Water, due to inefficiencies in the UPA recovery of water from urine and losses during EVA due to PLSS cooling requirements. Within the habitation module, this value is set to 74%, based on reported ISS flight data²⁹; and
- Nitrogen, due to atmospheric leakage makeup requirements.

The depletion of these stores over time is shown in Figures 12 to 14.

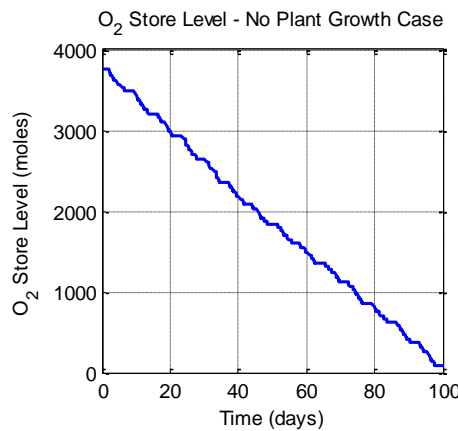

Fig. 12: O2 Depletion Rate for the No-Plant Case

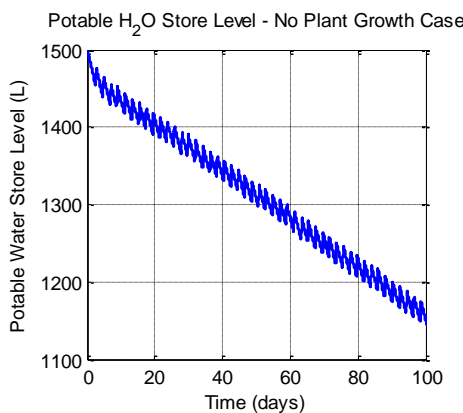

Fig. 13: H2O Depletion Rate for the No-Plant Case

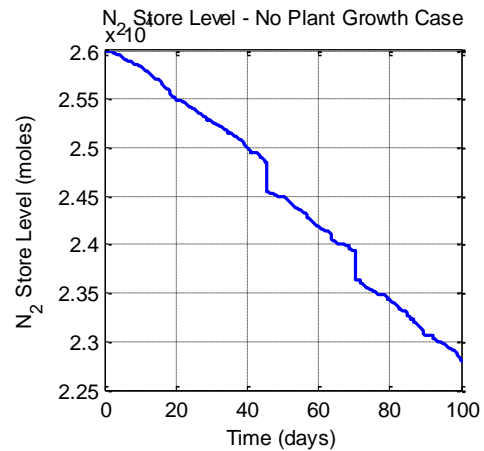

Fig. 14: N2 Depletion Rate for the No-Plant Case

These resource depletion rates correspond to the following ISRU requirements over the 26 month period between resupply missions from Earth:

ISRU Resource Requirement	Value
H2O (Liters/day)	3.12
O2 (moles/day)	38.4
N2 (moles/day)	36

Table 5: ISRU Requirements for the Crewed Phase of the No Plant Growth Case

Furthermore, this analysis found that to sustain the crew over the initial 26 month cycle 2,351kg of food was required to be delivered from Earth. This assumes a caloric density of approximately 3,400Calories/kg.

Habitat Option B – All Food is Locally Grown

Contrasting to the previous case, this alternative architecture attempts to make the baseline Mars One food system feasible. To accomplish this, two major changes were implemented:

1. All plant growth was moved to a dedicated plant chamber. This prevents the plants respiration and transpiration from interfering with the atmospheric requirements of the crew. Implementing this requires dedicating one of the Inflatable Units entirely to plant growth, which in turn removes the dual redundancy originally envisioned by the Mars One foundation.
2. Introducing an “Oxygen Removal Assembly (ORA)” to transfer excess oxygen from the plant chamber atmosphere to the oxygen tank. This makes use of a valuable resource that would otherwise be vented. It should be noted however, that while this technology has been extensively used in terrestrial applications, a space-rated version does not currently exist. Preliminary efforts were made to develop such a system³⁰ in the context of reducing ISS oxygen

resupply requirements in the post-Space Shuttle era, but no progress has been reported since 2011.

- Introducing a food processor to both extract edible biomass from mature crops, and to recover and recycle the water consumed by the BPS. Like the ORA, this is a notional technology that does not currently exist at the required scale

The corresponding ECLS and ISRU architecture is depicted in Figure 15. With this architecture established, we repeat the analysis performed in the previous section to determine the corresponding ISRU requirements.

During the pre-deployment phase of the mission, the gas demands on the ISRU system remain unchanged as compared to the no plant growth case. The water demand however, was found to be significantly greater, with an additional requirement of 11,000L generated by the BPS. This value was determined by an initial simulation of the BPS running in isolation, and is based on the assumption that when the first crew arrives at Mars, they will require a supply of water that can sustain the peak crop water demand over the first 26 months of their mission. Table 6 summarizes the ISRU requirements for the pre-deployment phase of a mission with this habitation architecture.

With regards to the ISRU requirements during the crewed phase of the mission, it was found that the introduction of the ORA removed the requirement for ISRU-derived oxygen due to the use of excess crop-generated oxygen. The rate of nitrogen use was slightly

larger than that of the no biomass production habitat case, and as was expected, the ISRU requirement for water remained high throughout the crew phase due to the crop water demand. Figures 16 to 18 show this resource consumption over the first 400 days of the mission.

ISRU Resource Requirement	Value
H2O (Liters/day)	28.1
O2 (moles/day)	24.6
N2 (moles/day)	68.2

Table 6: ISRU Requirements for the Predeployment Phase of the 100% Plant Growth Case

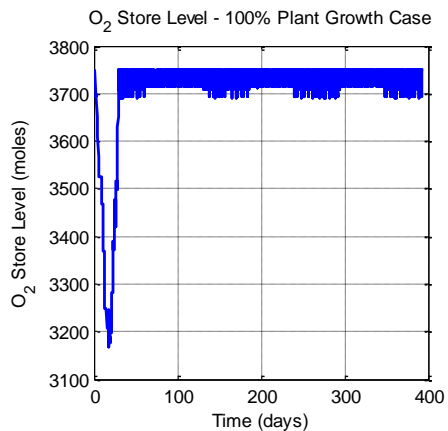

Fig. 16: O2 Depletion Rate for the 100% Growth Case

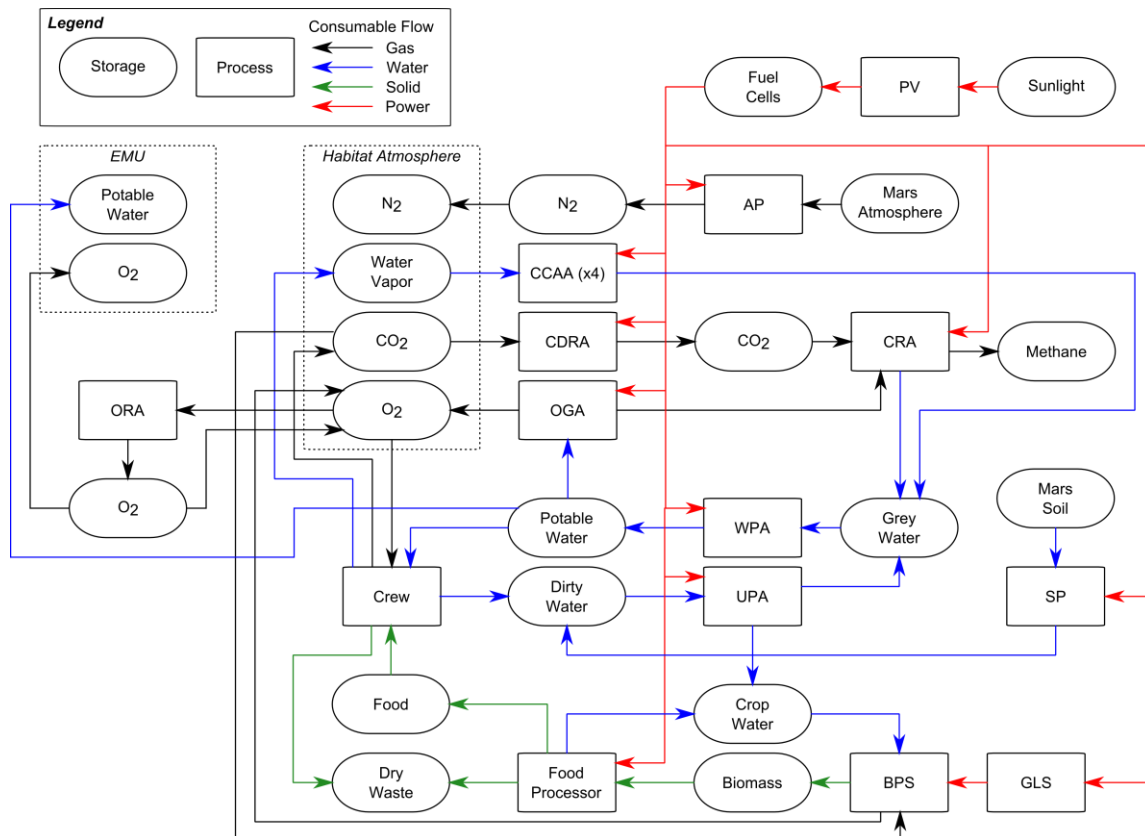

Fig. 15: Functional Flow Block Diagram for the 100% Plant Growth Habitation Case

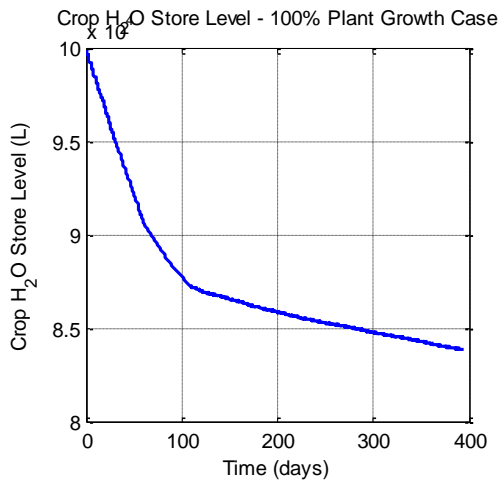

Fig. 17: Potable Water Depletion Rate for the 100% Plant Growth Case

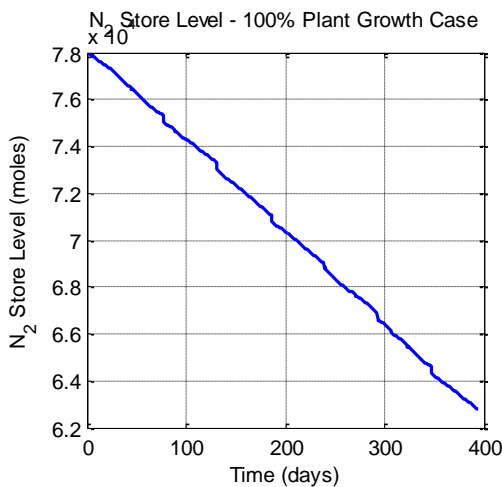

Fig. 18: N₂ Depletion Rate for the 100% Plant Growth Case

Table 7 summarizes the corresponding ISRU requirement for this mission phase

ISRU Resource Requirement	Value
H ₂ O (Liters/day)	27.1
O ₂ (moles/day)	0
N ₂ (moles/day)	40.8

Table 7: ISRU Requirements for the Crewed Phase of the 100% Plant Growth Case

Moreover, it was found that even though 100% of the food is grown in this case, some food still needs to be brought from Earth to support the crew over the period spanning between their first arrival, and the time at which the first crop batch matures. This requirement is depicted by the initial flat line in Figure 19. It was found that 406kg of carried food was required to sustain

the crew over this initial period. This equates to a 120 day supply of food for the crew, which is equal to the longest growth period of the selected plants.

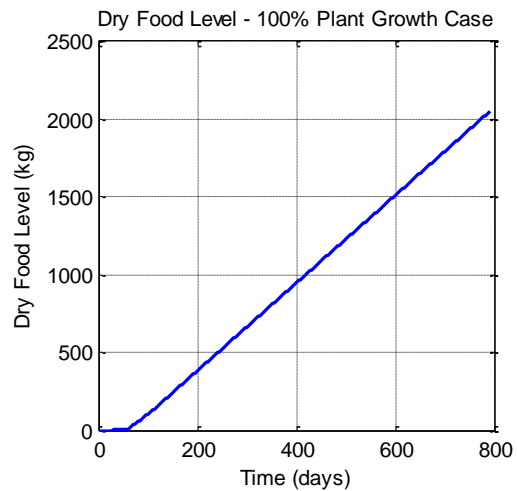

Fig. 19: Cumulative Dry Food Produced for the 100% Plant Growth Case

With the ISRU requirements derived for these two habitation case studies, the corresponding ISRU system can be sized to determine the total mass and volume of active equipment required for the Mars One mission. This process is described in the next section.

III-II In-Situ Resource Utilization Sizing Module

In-situ resource utilization (ISRU) will undoubtedly play a large role in any sustainable, long-term settlement on Mars. The Mars One architecture leverages resources from both the Martian soil and atmosphere. To produce water, a soil processor utilizes a specialized oven to evaporate the water ice in the local ground soil. This water will be condensed and a fraction will be electrolyzed to produce oxygen. The second system, an atmospheric processing module, utilizes the local atmosphere to produce nitrogen and argon for use in the habitat atmosphere. These two technologies represent the lowest-TRL components, as neither has spaceflight experience. This paper attempts, to the highest degree possible, to derive designs from existing hardware and literature in order to remain true to the Mars One technology plan of utilizing existing technology.

The soil processor (SP) module is derived from designs developed by Interbartolo et al. (2012)⁷. This module contains a hopper to hold regolith excavated by the rover, an auger to transport the regolith from the hopper to the oven, an oven with an internal auger to liberate the water ice in the regolith, and various screens and exit chutes to filter the soil prior to heating. A geometrically-similar design was scaled to provide the appropriate water production rate as dictated by the

ECLS simulations. That is, the ISRU requirements generated by the ECLS simulations were used to parametrically size the oven such that it could process enough soil to meet that demand. Once the oven geometry/design was determined, a mass estimate was generated using aluminium for most structures and titanium for high-temperature applications. A heater similar to that used by Interbartolo et al. was also included in the design, based off of the "The OMEGALUX Complete Electric Heater Handbook and Encyclopedia"^{7,31}. Although the design from Interbartolo et al. was used as a benchmark, future oven designs will likely incorporate many of the lessons learned from the hardware implementation of Curiosity rover's Sample Analysis at Mars instrument suite³². Soil water concentrations of 3%, which have been detected by Curiosity, were used, although higher concentrations on the order of 10% may perhaps be found^{32,33}.

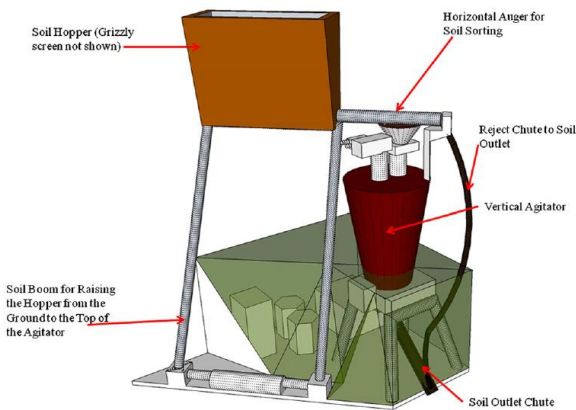

Fig. 20: The soil processing module, taken from Interbartolo et al., that was geometrically scaled to provide mass estimates for the Mars ISRU system.

The atmospheric processor (AP) module design is based more loosely on existing designs than the SP. The bulk of Martian atmospheric processing research has focused on obtaining CO₂ for the purpose of producing oxygen, but the Mars One architecture suggests a different use for the Martian atmosphere: the capture of inert gases for the purpose of maintaining the habitat atmosphere against leakage and EVA losses³³. The design of a gaseous processing system for capturing nitrogen and argon from a CO₂-rich atmosphere is somewhat different from existing techniques developed for CO₂ acquisition from the Martian atmosphere. Thus, the design detailed herein is strongly conceptual in nature and will require development prior to flight.

The first challenge of Martian atmospheric processing is compressing the low ambient pressure of 7-10 mbar up to a more typical value of 1 bar for typical processing technologies. Although vacuum pumps are ideal for such a requirement, they typically are too massive for space missions. Regression data from the

DVJ family of blowers by Dresser Roots was used to generate the estimated mass, volume, and power of the inlet compressor as a function of flowrate³⁴.

The compressed gas is then run through a cylindrical zeolite filter that selectively allows CO₂ to permeate to the atmosphere while retaining nitrogen and argon^{35,36}. To determine the required area of the zeolite membrane, a permeation simulation of the membrane was developed to calculate the required membrane area to achieve a certain cut fraction (the fraction of permeated gas flow over initial gas flow). The results from this model, shown below in Figure 21, were used to determine the surface area required to achieve a cut fraction of 0.99. A cut ratio of 0.99 was chosen to eliminate as much CO₂ as possible from the inlet stream while also avoiding too significant of a pressure drop (as the flow pressure approaches Mars atmospheric pressure, the effectiveness of the membrane filter drops dramatically). From Figure 21, we can see that even with such a dramatic filtering of the atmosphere, the retained flow still contains approximately 30% CO₂, with nitrogen and argon comprising the rest of the flow.

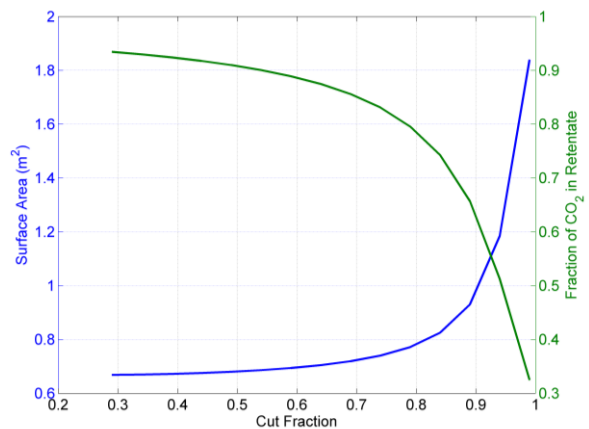

Fig. 21: The required surface area and retentate (retained gas) CO₂ for a range of cut fractions (ratio of retained to permeated gas) for a zeolite membrane designed to filter out CO₂ from the Martian atmosphere. A cut fraction of 0.99 was chosen for the atmospheric processor design.

Once a cut fraction was chosen, the required surface area was used to generate a membrane design with a pipe diameter of 5 cm. A zeolite membrane with a density of 2.1 g/cc, a void fraction of 0.45 and a CO₂ permeance of 5e-7 was used for this particular design³⁶. A thin aluminium supporting frame was designed around the zeolite membrane. This frame was assumed to cover 33% of the zeolite surface area, so the length of the membrane was increased by 50% to achieve the required surface area. After passing through the zeolite membrane filter, the gas is compressed to tank pressure and directed to one of two cryocoolers (operating out of

phase in parallel, similar to a pressure-swing system) which freeze the remaining CO₂ out of the flow before venting the remaining nitrogen and argon to the appropriate storage tanks. These cryocoolers were modelled after the 16W CryoTel GT cryocooler³⁷.

It should be noted that it was assumed that four cryocoolers would be able to process enough gas, as simulating the performance of the cryocoolers was beyond the scope of this project. All other components in the AP were parametrically sized to produce enough inert gas to supply the average demand predicted by the ECLS simulations.

There were four different cases for which the ISRU system was sized. A pre-deployed system had to be designed to produce enough oxygen, nitrogen, and water to inflate the habitat and fill the reservoir tanks prior to human arrival. After the arrival of the first crew, this system was assumed to continue operations to prepare for the second crew's arrival. The second ISRU system that was sized was a "support" system design to resupply resources to counteract atmospheric leakage and EVA losses. These two types of ISRU systems, the pre-deployed and the support system, had to be sized for both the "100% Plant Growth" and "No Plant Growth" scenarios described in the ECLSS section above.

To appropriately combine the mass estimates from the ISRU system with those from the ECLS system, both a margin and contingency had to be added to the ISRU system mass estimate. This is because the mass and volume estimates for the ECLS system are based on actual hardware data while the ISRU system mass estimate comes from conceptual designs of relatively low-TRL technology. The atmospheric processing module is at a relatively low TRL; all of the technology has undergone a proof-of-concept demonstration, but, to the author's knowledge, no integrated test of such a system has been conducted. There has been significant development of a Mars atmospheric processing unit for capturing CO₂ from the atmosphere, but no such development has occurred for a system to capture Nitrogen and Argon³³. Thus, we estimate the atmospheric processor to be around TRL 3. The soil processing module is at a slightly higher TRL, as oven technology has been demonstrated on Martian soil in a relevant environment, but not anywhere near the scale of a full ISRU system. We estimate soil processing technology to be around TRL 4-5³². Given the low TRL and conceptual nature of the system design, a mass and volume contingency of 30% along with a margin of 25% was included in the design³⁸. A complete listing of mass and volume estimates for the components of the ISRU system, including both the contingency and margin adjustments, is presented in Appendices E and F.

III-III Sparing Module

The initially deployed system (both for ECLS and ISRU) is only one portion of the mass required to support the crew in the time between resupply missions and the arrival of new crewmembers. A supply of spare parts will also be required to maintain the system as components fail or reach the end of their design lifetime. The continued operation of the ISS is dependent upon regular (and even unplanned) resupply of replacement parts from Earth, and in the event of an unrecoverable system failure the crew have the option to quickly return to Earth¹⁰. On Mars, resupply logistics will be much more challenging and there will be no feasible option for the crew to return to Earth in a timely manner. The ability of the crew to repair the systems that sustain them – and therefore the availability of spare parts to implement repairs – is critical to mission safety¹¹. This section describes the analysis used to determine the number of spares required for each repairable element in the system over the two-year period between resupply missions. The required number of spares considers both random failures and scheduled repair, where the number of spares associated with random failures is based upon the requirement of a probability of 0.99 that enough spares are available to repair the random failures between resupply. We first present the assumptions used, then describe the analysis methodology and its implementation. Finally, the results of the spares analysis are presented.

Assumptions

Spares analysis was conducted for ECLS, ISRU, and EVA hardware, as they are critical to the survival of the crew. The data used are presented in Appendix E. The primary values of interest for each component are the mean time between failures (MTBF) and life limit (LL). The MTBF for a given component is the inverse of the failure rate, and gives the average time between failures of a given component. The LL indicates the frequency of scheduled repairs for that component; the component is replaced every time it reaches its LL. As the Mars One ECLS architecture and technology is considered to be "very similar to" ISS ECLS technology, the MTBF and LL for ISS equipment are utilized for the analysis of ECLS spares demands^{19,39}. The values listed in Appendix E are based on BVAD unless otherwise noted¹⁵. Data are much scarcer for ISRU systems, and therefore reliability data for those systems are determined based on analogy to ECLS equipment wherever possible. If no suitable analogy is present, an MTBF of 500,000 h is assumed – this is considered to be an optimistic value, as it is higher than most of the MTBF values for ECLS components. The primary EVA components considered are the batteries, as they are items that are only useable for a limited number of EVAs; for this analysis, data for the EMU Series 2000

battery are used as an analogy to the batteries that will be used for Mars surface systems⁴⁰.

Random failure is modelled using an exponential distribution, or constant failure rate model – a commonly used first-order model of component failure behaviour. The Probability Density Function (PDF) describing the time to failure of a component is given by Equation [2]⁴¹.

$$f_{fail}(t) = \frac{1}{MTBF} e^{-\frac{t}{MTBF}} \quad [2]$$

The number of scheduled repairs is calculated by dividing the mission duration by the LL of the component and rounding down to the nearest integer, as shown in Equation [3].

$$n_{repair} = \left\lfloor \frac{t_{mission}}{LL} \right\rfloor \quad [3]$$

We assume that the overall number of spares required for a given component is dominated by either scheduled repairs or random failure; thus the number of spares corresponding to scheduled maintenance and random failures are calculated separately, and the larger of the two results is used. For components with no LL, only random failures were considered. This analysis focuses on processing components - storage tanks and other buffers are assumed to not fail.

The concept of operations for component replacement is assumed to follow the ISS paradigm of remove-and-replace maintenance. When a component failure occurs, the portion of the system containing that component is shut down and the backup system (in this case, the redundant Life Support Unit) is brought online to support the system during maintenance. The failed component is replaced with an identical spare, and the primary system is brought back online once maintenance is complete⁴². For simplicity, the Mean Time To Repair (MTTR) for any component is assumed to be 12 h (with a standard deviation of 1 h), and repairs are assumed to bring the system back to good-as-new condition. The time required for repairs is modelled using a log-normal distribution, which provides a good representation of a corrective repair process^{43,44}. The PDF of the repair time distribution is shown in equation [4] for the MTTR and standard deviation given above, the shape parameter σ and log-scale parameter μ are equal to 0.0832 and 2.4814, respectively.

$$f_{rep}(t) = \frac{1}{t\sqrt{2\pi}\sigma} e^{-\frac{(\ln(t)-\mu)^2}{2\sigma^2}} \quad [4]$$

The storage tanks and buffers within the system are assumed to be large enough to isolate failures while they are repaired; that is, the failure of a processor does

not cause downstream processors to go offline due to a lack of resource supply. As a result, failure of a particular component only causes downtime for the assembly including that component.

The ISS implements sparing using Orbital Replacement Units (ORUs) as the nominal “building block” of systems. These ORUs are designed to minimize the crew time required to implement repairs by encapsulating complex systems in easily replaceable packages. However, implementing spares at a lower level has the potential to reduce the total mass and volume of spares required, though it may increase the required mass of support infrastructure such as tools and diagnostic equipment¹¹. For this analysis, spares are implemented at the lowest level of component for which data were found in order to minimize mass. In general, this consists of subassembly-level sparing for ECLS and ISRU technology.

While the redundant Life Support Unit is brought online during repair operations on the primary Life Support Unit, we assume that the amount of operational time on the secondary unit is negligible. Calculations using the methodology described below found the expected primary system downtime (and therefore redundant system operational time) to be approximately 7.45 days – less than 1% of the 26 month time between resupply opportunities from Earth – thus supporting this assumption. As a result, spares analysis is not conducted for this redundant unit.

Finally, since the goal of this analysis is to determine a logistics demand and not to calculate the probability of system failure, it is assumed that all repairs are completed successfully. This is based both upon the assumption that buffers isolate failures and the fact that the redundant Life Support Unit can sustain the crew in the event of failure of the primary unit.

Methodology

The ECLS and ISRU systems were modelled as Semi-Markov Processes (SMPs), with states and transitions defined by failure and repair of system elements. The SMP model structure provides a framework to calculate several values of interest. For this analysis the Markov renewal probabilities for the various states are used to determine the minimum number of spares required for each system element in order to achieve a threshold probability of having enough spares to repair the random failures that will occur over the course of the mission. In addition, the expected time spent in partially failed states gives an estimate of the system downtime and the resulting operational time put on the redundant Life Support Unit, as described above⁴⁵⁻⁴⁷.

As a result of the assumption that all repairs are completed successfully, the SMP state network contains no fully failed state, and is not used to calculate the

probability of system failure. Instead, failure of a component places the system in a partially failed state from which the only exit transition is repair of that component. The assumption of buffers large enough to isolate failures also enables a partitioning of the system and examination of one ECLS/ISRU assembly at a time, thus enabling one-failure-at-a-time analysis (since the failure of a subassembly will take the entire assembly offline until the subassembly is repaired). This greatly simplifies the analysis process, and results in SMP diagrams of the form shown in Figure 22. Each failure transition is described by an exponential distribution based on the component’s MTBF (see Equation [2]); each repair transition is described by the lognormal repair distribution (see Equation [4]).

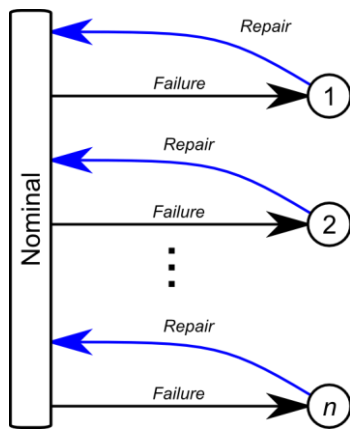

Fig. 22: SMP diagram for a one-failure-at-a-time analysis, showing failure/repair cycles for n components. Once the assembly leaves the nominal state due to failure of one of its subassemblies, the only possible transition is a repair of the failed subassembly.

In the case of the GLS, the 875-light array is not shut down to repair a single failure; instead, the failed light system is repaired individually. Since all lights are identical and have exponential failure distributions, this repair paradigm can be modelled by calculating the Markov renewal probability for a single failure/repair cycle where the failure distribution MTBF is equivalent to the MTBF of the distribution of the minimum of a set of 875 simultaneous exponentially distributed processes, calculated using Equation 5.⁴⁸

$$MTBF' = \frac{MTBF}{875} \quad [5]$$

The overall probability that the system has sufficient spares is the product of the probabilities for each component. For this analysis, the system probability requirement of 0.99 is distributed evenly among the various components of the system. That is, for a system with n repairable components, each component must

supply sufficient spares to provide a probability greater than p , as described by Equation [6]:

$$p = 0.99^{\frac{1}{n}} \quad [6]$$

Using the Markov renewal probabilities for each partially failed state, the number of spares required to achieve a probability greater than p that enough spares are supplied was calculated for each component.

The number of spares calculated via the Markov renewal process accounts for random failures; for parts that have scheduled repair based on a LL, the number of spares used by scheduled repairs is calculated using Equation [3]. Then, following the assumption that the overall number of repairs required is dominated by either random failure or scheduled repair, the larger of these two numbers is taken as the required number of spares for that component.

Results and Discussion

The number of spares required for each component is shown in Appendix F. As shown in Table 8, for the system including a BPS, the total mass of spares required for two years of operation of a system for four crewmembers is approximately 13,465 kg. For the system without a BPS (in which stored food is utilized for all nutritional requirements), the total mass of spares required is 10,384 kg. Note that this second case is the mass of spares for maintenance purposes only, and does not include the mass of stored food that must be resupplied.

The primary difference between the two cases is a reduction in the mass of spares required for the ECLS. This is due to the fact that a BPS-free system does not require a GLS or an ORA, and therefore does not need spares for these items. The mass of spares required for the Pre-Deployed ISRU (PDISRU) system also decreases, while the mass of spares for the ISRU system increases slightly. These effects are primarily due to changes in the mass of ISRU components as a result of changes to the loads on the system. There are also small changes in the number of spares required for the same component in each case due to the change in the overall number of components in the system and the resulting change in the probability threshold required for each individual component.

	Mass [kg] (BPS)	Mass [kg] (Stored Food)
PDISRU	2,111	1,255
ISRU	703	787
ECLSS	10,448	8,140
EVA	203	203
Total	13,465	10,384

Table 8: Mass of spares required for the first crew, with breakdown by subsystem.

As previously mentioned, the sparing analysis was conducted with a threshold probability of 0.99. This probability indicates that for 1 in 100 cases, a failure will occur within the system that cannot be repaired because no spare part is available. In this case, the crew would be forced to survive on the secondary Life Support Unit – in a loss-of-redundancy condition – until the next resupply mission. This probability was chosen somewhat arbitrarily for the purposes of this analysis. The effect of changes in this probability requirement on the total mass of spares required for the first crew is shown in Figure 23. As the probability requirement increases (approaching 1 asymptotically), the mass of spares required increases exponentially.

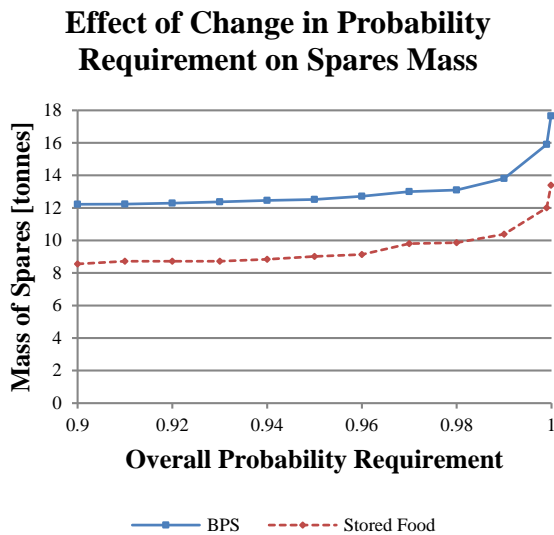

Fig. 23: Effect of changes on the required probability of having sufficient spares.

III-IV Logistics Module

Assumptions

The logistics of transporting items to the surface of Mars plays a major role in any mission architecture. The Mars One architecture explores a new paradigm of one-way trips to Mars without considering the return trip to Earth. For such long-term missions, sustainability plays an important role - it is crucial to consider the feasibility of the logistics and transportation over time for both the pre-deployment phase and crewed phase. The logistics considerations included in this paper include the:

- Transportation feasibility for both cargo and crewed missions
- Heuristics-based launch manifest optimization
- Systems integration and launch cost computations

The Mars One mission plan anticipates using a SpaceX Falcon Heavy rocket, an upgraded version of the Falcon 9. For the lander, the same variant of the Dragon Capsule used for the Mars habitat is used³⁹.

In this paper, we assume the following sizing parameters for the Falcon Heavy rockets and the landers. The sizing information for the lander, which has not been developed yet, is acquired from an unofficial source⁸, and compares well to scaled up numbers from the Red Dragon study performed by NASA and SpaceX. The assumed values are as follows:

Falcon Heavy⁴⁹:

- Payload to Low-Earth Orbit: 53,000 kg
- Payload to Trans-Martian Orbit: 13,200 kg

Lander (a 5m-diameter variant of Dragon)^{3,8,50}:

- One lander is delivered by one Falcon Heavy launch
 - Lander Mass: 13,200 kg
 - Payload Mass: 2,500 kg
 - Payload Volume: 25 m³ (pressurized)
 - Recurring Cost: ~\$300M for launch vehicle and lander
 - Propulsive Entry, Descent, and Landing (EDL)
-

Note that this paper trusts the EDL capability of the lander, which is expected to be developed by SpaceX. The Red Dragon study selects propulsive landing as the baseline option for the Dragon Martian EDL⁵⁰. This paper assumes that the same technology is available; therefore no detailed EDL feasibility analysis is performed.

All cargo except the Inflatable Units are assumed to be accommodated in the pressurized volume of the lander. This exception arises because with a predicted mass of 4,580 kg (based on equivalency coefficients from BVAD¹⁵), the Inflatable Unit is heavier than the stated pressurized payload capacity of the assumed Dragon vehicle. Even with this being the case, landing an Inflatable Unit with the Dragon lander may in fact be feasible, as the Inflatable does not require pressurized volume, which may enable additional lander capacity.

Although the crew will use the same type of lander, they also require a separate vehicle, the Mars Transit Vehicle (MTV), to support them on their journey to Mars. Mars One assigns a 20,000 kg mass budget for the MTV⁵¹. The MTV vehicle and the crew lander are launched with the assembly crew on-board, and are followed by the launch of two propulsion stages used for trans-Mars injection. After the integration of the MTV, the Mars crew is launched and the assembly crew comes back to the Earth. As a result, transporting a single crew to Mars requires four Falcon Heavy launch in total. Before entry into the Martian atmosphere, the crew moves to the lander and the MTV is discarded. In this feasibility analysis of the MTV design, the assumed system mass breakdown is based on past mission analyses^{15,52-54}.

Methodology and Subsystem Results

The logistics analysis can be divided into a vehicle feasibility analysis and manifest optimization.

We assume that one lander can be delivered to Mars with one Falcon Heavy launch. However, the current Falcon Heavy launch capability is 13,200 kg into Trans-Martian Orbit⁴⁹, and the estimated gross lander mass including the payload is 14,400 kg. Therefore: 1) a Falcon Heavy launch cannot deliver the lander with payload to Trans-Martian Orbit and 2) even if that is somehow possible with a design change, it only achieves the Trans-Martian Orbit burn ($\Delta V = 3.8$ km/s) and does not include a propulsion system for the Martian Orbit Insertion burn ($\Delta V = 1$ km/s).

This issue can be resolved by using an aerobraking manoeuvre for the Martian orbit insertion and/or by adding another propulsive stage, but these options require design change or technology development. For the rest of the paper, we assume one lander can be delivered by one Falcon Heavy launch.

For the crewed mission, the MTV requires two stages to deliver cargo. The staging mass is summarized in Table 1. The crewed mission is feasible with 3 launches (2 for propulsive stages and 1 for the MTV and lander vehicles) given the launch capability of Falcon Heavy.

Module	Mass [t]
Stage 1	50.6
-Propellant	43.5
-Structure	7.1
Stage 2	50.6
-Propellant	43.5
-Structure	7.1
Payload	33.2
- MTV+Crew	20
- Lander	13.2
Total IMLEO	134.4
Number of Launches (including a separate crew launch)	4

Table 9: Crewed Mission Vehicle Summary. IMLEO stands for Initial Mass to Low-Earth-Orbit.

A more detailed analysis is performed for the MTV. The subsystem breakdown of the MTV is computed based on past studies, namely the Mars Design Reference Architecture (DRA) 5.0^{52,53}. Among the subsystems, the following are the major differences between the MTV for Mars One and DRA 5.0:

- Mars One has four crew, whereas DRA 5.0 has six.
- The Mars One MTV ECLS is open-loop, with no recycling of water or oxygen. DRA 5.0 contains food production and a water reclamation system.
- The Mars One MTV does not account for any EVA during the transportation to Mars, whereas DRA 5.0 does, for contingency purposes.

The resulting MTV mass breakdown is shown in Table 10. It shows that the required mass (not including spares and margins) has only 10.6% margin. This design

is still feasible, but given the large uncertainties in space technology, it would be preferable to have a higher mass budgeted for the MTV.

Subsystem	Mass [kg]
Power	5840
Avionics	290
ECLS	1273
Thermal	1260
Crew Accommodation	3256
Structure`	1400
Crew	257
Consumables	4500
- Food	800
- Water	3000
- Oxygen	700
Total (excluding spares & margins)	18076
Proposed MTV mass budget	20000
Margin	10.6%

Table 10: MTV mass breakdown.

One important aspect in the logistical analysis is manifest optimization⁵⁴. Given the list of components and spares, it is important to optimally pack them into as few landers as possible. In this paper, a 3-D manifest optimization is not performed due to lack of component dimension data. Instead, only mass and volume constraints are considered. The resulting formulation is a classical optimization problem, a bin packing problem:

Objective:

J: # of vehicles that are used

Variables:

$x_{ij} = 1$, if item i is accommodated in vehicle j ;

0 otherwise

$y_j = 1$, if vehicle j is used;

0 otherwise

Parameters/Constants:

N: # of items (including packing)

m_i : mass of item i (including packing)

v_i : volume of item i

M: mass of a vehicle

V: volume of a vehicle

Integer Programming (IP) Formulation:

$$\min J = \sum_{j=1}^N y_j \quad [7.1]$$

$$\text{s.t. } \sum_{j=1}^N m_i x_{ij} \leq M y_j \quad \forall i \in \{1, \dots, N\} \quad [7.2]$$

$$\sum_{j=1}^N v_i x_{ij} \leq V y_j \quad \forall i \in \{1, \dots, N\} \quad [7.3]$$

$$\sum_{i=1}^N x_{ij} = 1 \quad \forall j \in \{1, \dots, N\} \quad [7.4]$$

$$x_{ij}, y_j \in \{0, 1\} \quad \forall i \in \{1, \dots, N\}, \forall j \in \{1, \dots, N\} \quad [7.5]$$

This Integer Programming (IP) optimization problem was solved using the commercial software IBM ILOG CPLEX, resulting in the optimal number of launches and thus logistical cost.

IV. INTEGRATED RESULTS AND DISCUSSION

IV-I Results

In this section, we describe the integrated results combining the ECLS, ISRU, sparing, and logistics analyses described above. The ELCS and ISRU analyses provide a components list and the sparing analysis provides the number of spares required for each repairable component, as shown in Appendices E and F. Using these results, the overall mass and volume characteristics of the ECLS, ISRU, and other systems considered in this analysis are generated. Using this information, the logistics analysis provides the required number of launches and their recurring cost. This section presents the results from these analyses as an overall mission campaign, including launch schedule and cost estimates.

Two cases were considered for this analysis, differentiated by the method in which food is provided to the crew. In the first case – the architecture described by Mars One – a BPS is used to grow all food. As described in Section III.I, this mission architecture resulted in unexpected challenges with regard to atmosphere control, and required the implementation of a notional space-rated oxygen removal technology, the ORA. To examine another potential system that adheres to the Mars One claim of no new technology development, we also analysed the case where stored food (SF) supplies all nutrition for the crew.

The results presented here examine the logistical demands of the ECLS, ISRU, and crew systems for the first ten years of the Mars One campaign, starting with the landing of the Pre-Deployed ISRU (PDISRU) system in 2022 and going through the landing of the 5th crew in 2032. The results are presented in three forms for each case, examining 1) the cargo mass required for each launch and its distribution among the examined systems, 2) the cumulative mass delivered to the surface of Mars, and 3) the number of launches required and resulting estimated launch cost. These results are described in further detail in the following subsections, and are displayed in Figures 24 through 26.

Cargo Mass Breakdown

Figure 24 shows the distribution of landed mass (for the systems described in this paper) for the first five crew arrivals as well as the pre-deployed ISRU system sent approximately two years before the first crew. This chart shows the breakdown of mass between the primary and secondary ECLS, ISRU, and crew systems, as well as the spares required for those systems, thus

giving insight into the mass cost of the various elements of the habitat. Note that only the infrastructure, consumables, and spare parts required to support them are shown in this figure.

In the BPS case, the pre-deployed system has a mass of just over 38 tonnes, and the first crew lands with approximately 52 tonnes of cargo, including systems for the second crew and spare parts. For each subsequent crew, the mass of spares increases due to the increased number of systems operating on the surface. At the 10-year mark, the 5th crew is accompanied by over 100 tonnes of cargo, 64% of which is spare parts. The SF case follows a similar trend, starting at a lower mass – approximately 28 tonnes and 39 tonnes for the pre-deployed system and first crew, respectively. The 5th crew arrives with just over 88 tonnes of equipment.

Cumulative Mass

Figure 25 shows the cumulative mass delivered to the surface of Mars to sustain the Mars One ECLS, ISRU, and crew systems over the first 20 years of operation. As a result of the growth in the mass required for each crew (described in the previous section), the cumulative mass grows in a nonlinear fashion. This figure shows that the BPS-based system remains the higher-mass option (over stored food) for the first two decades of operation at least; the crossover point does not occur within any reasonable timeframe from the start of the mission.

Number and Cost of Launches

Figure 26 shows the number of required Falcon Heavy launches for the first ten years of Mars One mission corresponding to the launch system requirements to deliver the mass shown in Figure 24 to the surface of Mars. Additionally, an estimate of the recurring cost of vehicle preparation and launch (in billions of USD) is provided on the secondary axis. This is based on a scaled estimate of the Red Dragon analysis performed by NASA and SpaceX, as stated in Section III.IV.

The values here include both cargo and crew launches. Specifically, the first launch campaign is for cargo predeployment for the first crew, while the second launch campaign includes both delivery of the first crew and cargo predeployment for the second crew. Since each crew requires four Falcon-Heavy launches (see Section III.IV), 21 launches (17 for cargo predeployment + 4 for crew launch) are required to deliver the first crew to the Martian surface for the BPS analysis case. This has an equivalent launch cost of \$6.3billion. Similarly, the SF case requires 15 launches (11 for cargo predeployment + 4 for crew launch) and \$4.5billion to land the first crew on Mars.

IV-II Discussion

Mass Growth

An important trend appears in Figure 24: the amount of mass required by the system increases with the number of crews on the surface. This is due to the fact that each crew of 4 is supported by their own ECLS and ISRU. The number of spares calculated in Section III.III applies to a single system supporting a single crew. When the second crew arrives, two systems will be in operation, requiring twice as many spares, and so on for each subsequent crew. The only exception is the PDISRU system, which is assumed to be reused for the preparation of every crew's habitat; for this system, only one set of spares is required for each crew arrival. For the SF case, as one would guess, the amount of resupply food required increases linearly with the number of crews already on the surface. The resupply cost of food only takes effect starting at the 2nd crew, however, since the stored food for an arriving crew is considered part of that crew's ECLS; the resupply food is for the crewmembers that are already there, not the ones who are arriving.

This is a first-order estimate of mass requirements based on the need to provide the same level of assurance to each crew, and could be somewhat reduced by taking advantage of commonality between the different Life Support Units and informing spares manifesting based on the performance of the surface systems up until the launch date. However, the inescapable truth is that as more systems are deployed and operated on the surface of Mars, more spares will be required to maintain them. The Mars One website notes this challenge, stating that "for a long time, the supply requests from the outpost will be for complex spare parts, which cannot be readily reproduced with the limited technology on Mars"⁵. Without advanced manufacturing capability on Mars – which would involve both significant technology development efforts as well as (most likely) a very large mass transported to Mars from Earth – this demand for spare parts can only be met with supplies from Earth, and indicates that the mass required to resupply the Mars One colony will increase significantly as the colony grows.

Number of Launches

The Mars One mission plan states that six Dragon capsules will carry all necessary supplies for the pre-deployment phase¹. However, based on our analysis, the mass required for this pre-deployed system exceeds the payload capacity of these six capsules (see Figure 26). This indicates that the launch estimates given by Mars One are overly optimistic in terms of system logistics, based on our assumptions and analysis.

As the mission enters its expansion phase, and more crews and habitation systems are sent to the surface, the

requirement for spares and supplies increases, driving up the required number of launches. For the third crewed mission, the required number of launches exceeds 30, a value more than five times that of the 6 launch requirement claimed by Mars One for each crew expansion mission. This increase is mainly driven by demands on ECLS spares, which grows quickly and becomes dominant after the first few missions.

With the exception of the Inflatable Unit, this logistics analysis assumes that all components are carried using a pressurized cargo vehicle. It is possible that some of the cargo does not need to be transported in a pressurized space, which may allow the lander to carry more payload mass or volume than our estimates. However, given current Entry Descent and Landing (EDL) technologies, it is infeasible to use six lander capsules, as proposed by Mars One. This is because six capsules weigh a total of 81 tonnes upon Mars entry, and are tasked to land more than 38 tonnes on the surface (even for pre-deployment). This corresponds to an EDL gear ratio of 2.1, which is significantly less than that of the 3.6 gear ratio value of the Mars Science Laboratory (MSL) mission⁵²). Therefore, even with the most advanced EDL system currently available, only 22.5 tonnes can be landed on the surface - it is not possible to pre-deploy the estimated mass of the habitat using six Dragon landers. We conclude that either additional EDL technology development, or additional launches are required to realize the baseline Mars One plan.

Biomass Production System vs. Stored Food

Two cases are considered in this analysis: one with a BPS, and using entirely stored food (SF). Figure 25 shows the difference between these two options. Based on these results, the use of a BPS for food production does not pay off in terms of system mass within a reasonable time horizon. Even after two decades of operation, the BPS option still results in significantly more mass delivered to Mars than SF.

The use of a BPS increases the initial mass of the system with the goal of reducing resupply requirements by producing food in-situ. However, this analysis finds that the resupply requirements are nearly the same for the case with a BPS, as compared to the case using stored food. This is due to the increased infrastructure (GLS, ORA) required to support the BPS, as well as changes in the size of the ISRU systems, and the resulting increased spares requirement. Without the benefits of a reduced resupply requirement, the BPS-based system remains the most mass-intensive system for quite some time.

These two cases represent the two extremes of the spectrum, where either all of the food is produced on-site or none of it is. In addition, each BPS is associated with a specific crew, as part of their life support system.

ECLS/ISRU/Crew Systems Mass Breakdown

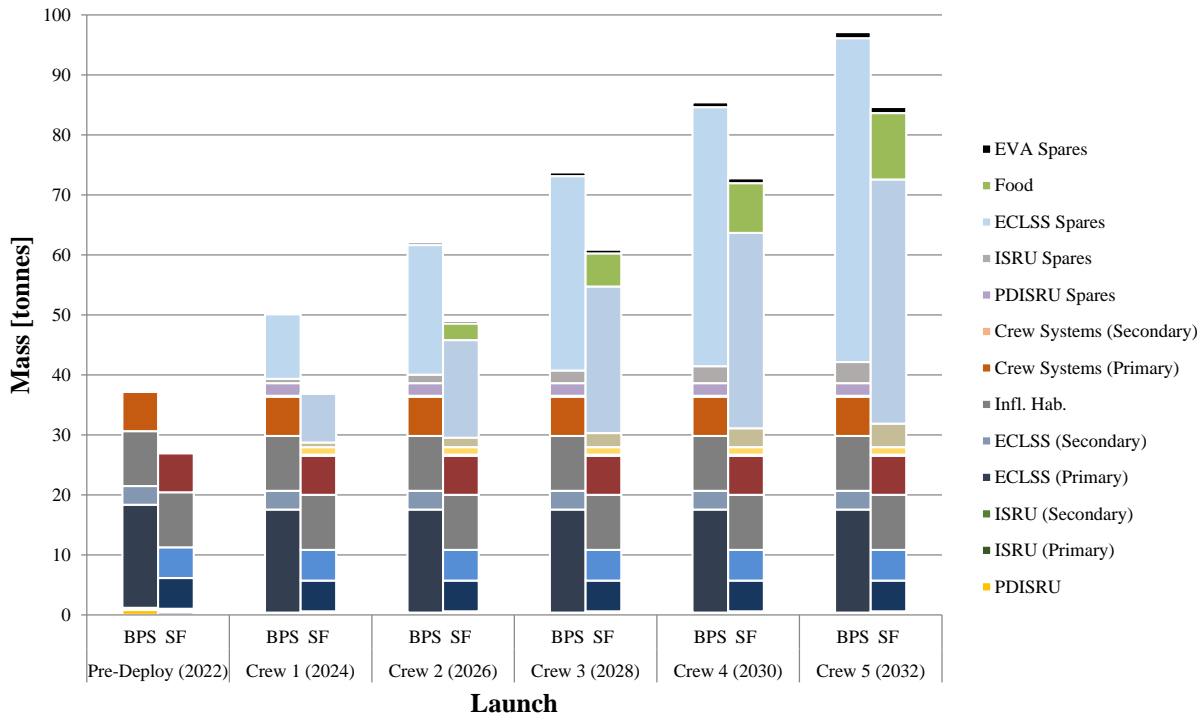

Fig. 24: Mass breakdown of the cargo missions for the first 5 crews, including the pre-deploy mission. The mass for each mission is shown for both the architecture utilizing a BPS and the architecture using stored food (SF). The total mission mass is shown as a stacked bar of the primary and secondary systems, inflatable habitat (infl. hab.), spare parts, and resupply food.

Cumulative ECLS/ISRU/Crew Systems Mass Delivered to Surface

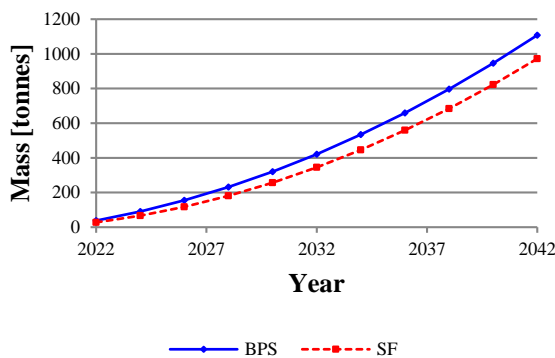

Fig. 25: Cumulative ECLS/ISRU/Crew Systems mass delivered to the surface in the first 20 years of Mars One operation for both the BPS and SF cases.

of Launches and Recurring Cost Estimates

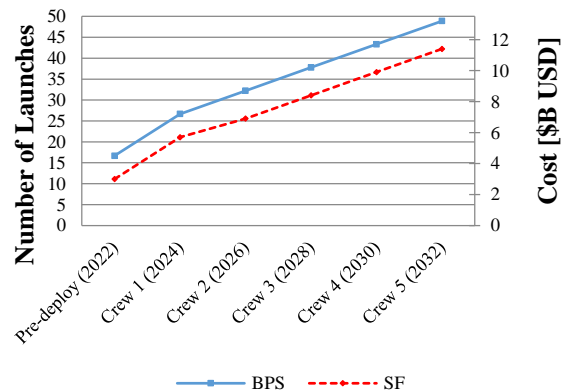

Fig. 26: Number of launches required and resulting estimated launch vehicle production and launch cost for the first ten years of Mars One operation for both the BPS and SF cases.

It is possible that a more optimal strategy could be developed, balancing between food shipped from Earth and food grown on Mars. For example, early crews could supplement their diet with stored food while gradually building up plant growth capability. In addition, a balance could be found that enables the use of plants to grow food without requiring an ORA; the spares for the ORA amount to just over one tonne per crew per resupply, and the elimination of this mass would reduce the overall resupply requirements.

Sensitivity to MTBF

The MTBF values used in this analysis are based as much as possible on current state-of-the-art ECLS technology with flight heritage on the ISS¹⁵. It is reasonable to expect, however, that the reliability of these components may increase before the start of the Mars One surface campaign. In order to investigate the potential benefits of more reliable components, the sparing analysis was repeated for four additional cases, increasing the MTBFs of all components in the system by 25%, 50%, 75%, and 100% from the baseline. The results are shown in Figure 27.

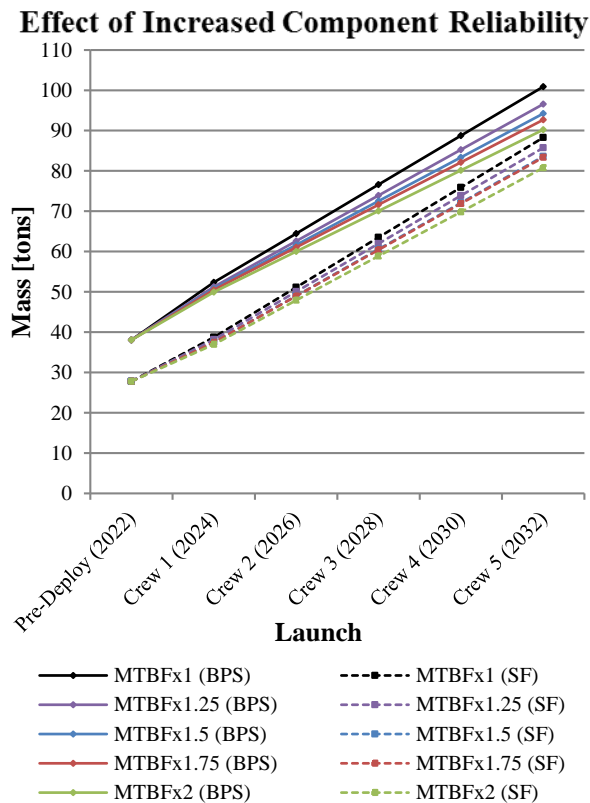

Fig. 27: Impact of increased component MTBF on the mass required for the first five crews. The total ECLS/ISRU/crew systems mass (including spares and resupply food) is shown for both the BPS and SF case, with MTBF varied between 1-2 times the baseline values.

As expected, increased component reliability reduces the mass of spares required. For the BPS case, doubling the MTBF reduces the total mass of spares required for a single crew by 2,406 kg, or about 15%. For the SF case, the reduction in spares mass is approximately 1,773 kg (also about 15%). When the mass of resupplied food is included, the SF case improvement drops to approximately 12%. Overall, higher reliability provides a reduction in the resupply mass requirements for both architectures. The benefits are slightly higher for the BPS case since the resupply mass is all spare parts – in the SF case, there is a fixed resupply mass of food that cannot be reduced through increased reliability. Even at double the current component reliability levels, however, the resupply requirements are still linearly increasing with the number of crews on the surface, and the mass that must be delivered in order to sustain the colony after the first couple crews arrive becomes very high.

ISRU Mass

One of the “pillars” of the Mars One mission plan is the use of in-situ resources in the Martian soil and atmosphere rather than sending consumable resources from Earth⁵. Figure 24 shows that the ISRU mass – both for pre-deployment and concurrent operation with ECLS – is very small, and does not require a large mass of spares. For a single system (taking the BPS case as an example), the mass of the ISRU system itself and the required spares for one year of resupply for one crew is approximately 1.8 tonnes. Over the course of the two-year inter-resupply period, the ISRU system generates over 22 tonnes of consumables – the mass of the ISRU system is just under 8% of the mass of consumables that would have to be delivered if it were not used. The pre-deployed ISRU system similarly reduces the mass required to set up and inflate the habitats before the crew arrive. These mass savings indicate that using ISRU to support Martian settlements is a clear avenue to system mass reduction. However, ISRU technology is still at a relatively low TRL, and therefore has significant uncertainty surrounding its mass and performance. A nontrivial technology development and demonstration effort, as proposed in the Mars One 2018 lander proposal, is required to bring them to maturity.

Other Systems

It is important to reiterate that the mass breakdown shown here includes only the ECLS, ISRU, and crew systems. Several key systems were beyond the scope of this analysis, and would need to be investigated in depth in order to provide an overall estimate for the cost of the Mars One missions. Specifically, the communications and power subsystems were not considered. As a result, the anticipated mass of a Martian settlement is expected to be larger than the one shown here.

V. CONCLUSIONS

Our integrated Mars settlement simulation revealed a number of significant insights into architecture decisions for establishing a Martian colony. First, our habitation simulations revealed that crop growth, if large enough to provide 100% of the settlement's food, will produce unsafe oxygen levels in the habitat. As a result, some form of oxygen removal system is required – a technology that has not yet been developed for spaceflight.

Second, the ISRU system sizing module generated a system mass estimate that was approximately 8% of the mass of the resources it would produce over a two year period, even with a generous margin on the ISRU system mass estimate. That being said, the ISRU technology required to produce nitrogen, oxygen, and water on the surface of Mars is at a relatively low TRL, so such findings are preliminary at best. A spare parts analysis revealed that the mass of spare parts to support the ISRU and ECLS systems increases significantly as the settlement grows - after 130 months on the Martian surface, spare parts compose 62% of the mass transported to the Martian surface.

Finally, the space logistics analysis revealed that for the most optimist scenario considered, establishing the first crew of a Mars settlement will require approximately 15 Falcon Heavy launches costing \$4.5 billion, and these values will grow with additional crews. It is important to note that these numbers are derived considering only the ECLS and ISRU systems with spare parts. Future work will have to integrate other analyses, such as communications and power systems, to capture a more realistic estimate of mission cost.

In general, technology development will have to focus on improving the reliability of ECLS systems, the TRL of ISRU systems, and either the capability of Mars in-situ manufacturing and/or the cost of launch. Improving these factors will help to dramatically reduce the mass and cost of Mars settlement architectures.

ACKNOWLEDGEMENTS

This work was supported by NASA Grants #NNX13AL76H and #NNX14AM42H, as well as the Josephine de Karman Fellowship Trust. The authors would like to thank Gerald Sanders of NASA Johnson Space Center for his advice concerning Martian atmospheric processing for ISRU.

DISCLAIMER

This paper is the result of the analysis carried out by a group of researchers at the Massachusetts Institute of Technology (MIT), sponsored by grants from NASA and the Josephine de Karman Fellowship Trust. The paper does not purport to represent the official views of MIT, NASA, or the Josephine de Karman Fellowship

Trust. Moreover, the authors would like to reiterate that the analysis presented here was based on the best available information available to them on the missions and technologies proposed. Should updated information become available, the authors would gladly update this analysis.

REFERENCES

- ¹ Mars One, "Mars One: Roadmap" Available: <http://www.mars-one.com/mission/roadmap>.
- ² Lockheed Martin, *Proposal Information Package Mars One 2018 Lander Payload*, Denver, CO: 2014.
- ³ "Dragon," *Space Exploration Technologies Corp.* Available: <http://www.spacex.com/dragon>.
- ⁴ Mars One, "Mars One: Roadmap 2023" Available: <http://www.mars-one.com/mission/roadmap/2023>.
- ⁵ Mars One, "Mars One: Technical Feasibility" Available: <http://www.mars-one.com/mission/technical-feasibility>.
- ⁶ Taylor, A., "This Incredible Plan For A Mission To Mars In 2023 Is No Hoax," *Business Insider* Available: <http://www.businessinsider.com/mars-one-hoax-bas-landorp-2023-2012-6>.
- ⁷ Interbartolo III, M. A., Sanders, G. B., Oryshchyn, L., Lee, K., Vaccaro, H., Santiago-Maldonado, E., and Muscatello, A. C., "Prototype Development of an Integrated Mars Atmosphere and Soil-Processing System," *Journal of Aerospace Engineering*, vol. 26, 2012, pp. 57–66.
- ⁸ "Would you Sign up for One-way trip to Mars?," *World-Mysteries Blog* Available: <http://blog.world-mysteries.com/science/would-you-sign-up-for-one-way-trip-to-mars/>.
- ⁹ SpaceX, "SpaceX Dragon" Available: <http://www.spacex.com/dragon>.
- ¹⁰ Cirillo, W., Aaseng, G., Goodliff, K., Stromgren, C., and Maxwell, A., "Supportability for Beyond Low Earth Orbit Missions," *AIAA SPACE 2011 Conference & Exposition*, Sep. 2011, pp. 1–12.
- ¹¹ Jones, H. W., Hodgson, E. W., and Kliss, M. H., "Life Support for Deep Space and Mars," *44th International Conference on Environmental Systems*, Tucson, AZ: 2014, pp. 1–15.
- ¹² Kortenkamp, D., and Bell, S., *BioSim: An Integrated Simulation of an Advanced Life Support System for Intelligent Control Research Users Manual (draft)*, NASA Johnson Space Center/ER2, Houston, TX 77058, Obtained from <http://svn.traclabs.com/biosim/documentation.html> & Metrica Inc. and S&K Technologies, 2003.
- ¹³ NASA HQ, *NASA Human Integration Design Handbook (HIDH) - NASA/SP-2010-3407*, Washington D.C.: 2010.
- ¹⁴ NASA JSC, *Recommendations for Exploration Spacecraft Internal Atmospheres - The Final Report*

- of the NASA Exploration Atmospheres Working Group (EAWG) - JSC-63309, Houston, TX: 2006.
- 15 Hanford, A. J., *Advanced Life Support Baseline Values and Assumptions Document (CTSD-ADV-484A)*, Houston, TX: 2004.
 - 16 Goudarzi, S., and Ting, K. C., *Top Level Modeling of Crew Component of ALSS*, SAE 1999-01-2042, 29th International Conference on Environmental Systems Denver, Colorado July 12-15, 1999: 1999.
 - 17 Rajulu, L., and Klute, G. K., *Anthropometric Survey of the Astronaut Applicants and Astronauts From 1985 to 1991*, Houston, TX: 1993.
 - 18 ESA blogteam, "Planning Down to the Minute," ESA Available: <http://blogs.esa.int/alexandergerst/2014/07/02/planning-down-to-the-minute/>.
 - 19 Mars One, "Mars One: Life Support Unit" Available: <http://www.mars-one.com/technology/life-support-unit>.
 - 20 Hanford, A. J., *NASA/CR-2006-213694 Advanced Life Support Research and Technology Development Metric – Fiscal Year 2005*, Houston, TX: .
 - 21 Mars One, "Mars One Roadmap 2025" Available: <http://www.mars-one.com/mission/roadmap/2025>.
 - 22 Jones, H., *Matching Crew Diet and Crop Food Production in BIO-Plex*, SAE 2000-01-2397, 30th International Conference on Environmental Systems Toulouse, France July 10-13, 2000: 2000.
 - 23 De zeen magazine, "Over 200,000 people apply to live on Mars" Available: <http://www.dezeen.com/2013/09/11/over-200000-people-apply-to-live-on-mars/>.
 - 24 Jones, H., and Cavazzoni, J., *Top-Level Crop Models for Advanced Life Support Analysis*, SAE 2000-01-2261, 30th International Conference on Environmental Systems Toulouse, France July 10-13, 2000: 2000.
 - 25 Boscheri, G., Kacira, M., Patterson, L., Giacomelli, G., Sadler, P., Furfaro, R., Lobascio, C., Lamantea, M., and Grizzaffi, L., "Modified energy cascade model adapted for a multicrop Lunar greenhouse prototype," *Advances in Space Research*, vol. 50, Oct. 2012, pp. 941–951.
 - 26 Jones, H., *Crop Models for Varying Environmental Conditions*, SAE 2002-01-2520, 32nd International Conference on Environmental Systems San Antonio, Texas July 15–18, 2002: 2002.
 - 27 Tri, T. O., "Bioregenerative Planetary Life Support Systems Test Complex (BIO-Plex): Test Mission Objectives and Facility Development," 1999.
 - 28 "L4A Series Tech Specs," *Heliospectra* Available: <http://www.heliospectra.com/products#techspecs>.
 - 29 Carter, L., Tobias, B., and Orozco, N., "Status of ISS Water Management and Recovery," *42nd International Conference on Environmental Systems, San Diego, CA, 15-19 July 2012*, 2012, pp. 1–12.
 - 30 Graf, J. C., *A Cabin Air Separator for EVA Oxygen*, AIAA 2011-5225, 41st International Conference on Environmental Systems 17 - 21 July 2011, Portland, Oregon: 2011.
 - 31 *The Omegalux complete electric heaters handbook and encyclopedia*, Omega Engineering, 1995.
 - 32 Leshin, L. A., Mahaffy, P. R., Webster, C. R., Cabane, M., Coll, P., Conrad, P. G., Archer, P. D., Atreya, S. K., Brunner, A. E., Buch, A., and others, "Volatile, isotope, and organic analysis of martian fines with the Mars Curiosity rover," *Science*, vol. 341, 2013, p. 1238937.
 - 33 Rapp, D., "Mars ISRU technology," *Use of Extraterrestrial Resources for Human Space Missions to Moon or Mars*, Springer, 2013, pp. 31–90.
 - 34 "DVJ Dimension Table," *Roots Dresser: Rotary Positive Blowers and Exhausters* Available: [http://www.pp-s.com/Files/Dresser Roots/All about Roots.pdf](http://www.pp-s.com/Files/Dresser%20Roots/All%20about%20Roots.pdf).
 - 35 Henley, E. J., Seader, J. D., and Roper, D. K., *Separation process principles*, Wiley, 2011.
 - 36 Shekhawat, D., Luebke, D. R., and Penline, H. W., "A review of carbon dioxide selective membranes," *US Department of Energy*, 2003.
 - 37 "CryoTel GT Specification Sheet," *SunPower - CryoTel GT: 16W Cryocooler*.
 - 38 Wertz, J. R., Everett, D. F., and Puschell, J. J., eds., *Space Mission Engineering: The New SMAD*, Hawthorne: Microcosm, 2011.
 - 39 "Mars One: The Technology" Available: <http://www.mars-one.com/mission/the-technology>.
 - 40 "NASA Extravehicular Mobility Unit (EMU) LSS/SSA Data Book (Rev. H)," 2002.
 - 41 Ebeling, C. E., *An Introduction to Reliability and Maintainability Engineering*, New Delhi: Tata McGraw-Hill Publishing Co. Ltd., 2000.
 - 42 Wieland, P. O., "Living Together in Space: The Design and Operation of the Life Support Systems on the International Space Station," vol. 1, 1998.
 - 43 Kline, M., "Suitability of the lognormal distribution for corrective maintenance repair times," *Reliability engineering*, vol. 9, 1984, pp. 65–80.
 - 44 Jones, H., "Life Support Dependability for Distant Space Missions," *40th International Conference on Environmental Systems*, Jul. 2010.
 - 45 Owens, A. C., and de Weck, O. L., "Use of Semi-Markov Models for Quantitative ECLSS Reliability Analysis: Spares and Buffer Sizing," *44th International Conference on Environmental Systems*, Tucson, Az: 2014.
 - 46 Owens, A. C., "Quantitative Probabilistic Modeling of Environmental Control and Life Support System Resilience for Long-Duration Human Spaceflight," Massachusetts Institute of Technology, 2014.

- ⁴⁷ Warr, R. L., and Collins, D. H., "An Introduction to Solving for Quantities of Interest in Finite-State Semi-Markov Processes," Dec. 2012.
- ⁴⁸ Bertsekas, D. P., and Tsitsiklis, J. N., *Introduction to Probability*, Belmont, MA: Athena Scientific, 2008.
- ⁴⁹ "Falcon Heavy," *Space Exploration Technologies Corp.* Available: <http://www.spacex.com/falcon-heavy>.
- ⁵⁰ Karcz, A. R. C. J., Allen, G., Davila, A., Heldmann, J., Lemke, L., Marinova, M., Stoker, C., and Trumble, K., "Red Dragon: Feasibility of a Dragon-derived Mars lander for scientific and human-precursor investigations," 2011, pp. 1–14.
- ⁵¹ "Mars One: Mars Transit Vehicle."
- ⁵² Drake, B. G., *Human Exploration of Mars Design Reference Architecture 5.0*, 2009.
- ⁵³ Drake, B. G., *Human Exploration of Mars Design Reference Architecture 5.0 Addendum*, Houston, TX: 2009.
- ⁵⁴ De Weck, O. L., Simchi-Levi, D., Shishko, R., Ahn, J., Gralla, E. L., Klabjan, D., Mellein, J., Shull, S. A., Siddiqi, A., Bairstow, B. K., and Lee, G. Y., "SpaceNet v1.3 User's Guide (NASA/TP-2007-214725)," 2007.
- ⁵⁵ Mars One, "Mars One - How much living space will the astronauts have?" Available: <http://www.mars-one.com/faq/health-and-ethics/how-much-living-space-will-the-astronauts-have>.
- ⁵⁶ Mars One, "Mars One - Will the astronauts have enough water, food and oxygen?" Available: <http://www.mars-one.com/faq/health-and-ethics/will-the-astronauts-have-enough-water-food-and-oxygen>.
- ⁵⁷ Mars One, "Mars One - What will the astronauts do on Mars?" Available: <http://www.mars-one.com/faq/mission-to-mars/what-will-the-astronauts-do-on-mars>.
- ⁵⁸ Papale, W., and Chullen, Cinda; Campbell, Colin; Conger, Bruce; McMillin, S., *Continued Development of the Rapid Cycle Amine System for Advanced Extravehicular Activity Systems*, 44th International Conference on Environmental Systems, 13-17 July 2014, Tucson, Arizona: 2014.
- ⁵⁹ NASA JSC, *Apollo Operations Handbook Extravehicular Mobility Unit*, Houston, TX: 1971.
- ⁶⁰ Schaezler, R. N., Cook, A. J., Leonard, D. J., and Company, T. B., *Trending of Overboard Leakage of ISS Cabin Atmosphere*, AIAA 2011-5149, 41st International Conference on Environmental Systems 17 - 21 July 2011, Portland, Oregon: 2011.
- ⁶¹ Erickson, R. J., Jr, J. H., Kulp, G. W., and Keuren, S. P. Van, "International Space Station United States Orbital Segment Oxygen Generation System On-orbit Operational Experience," *SAE Int. J. Aerosp.*, vol. 1, 2008.
- ⁶² Bagdigian, R. M., Cloud, D., and Bedard, J., *Status of the Regenerative ECLSS Water Recovery and Oxygen Generation Systems Environmental Systems (ICES)*, SAE 2006-01-2057, 36th International Conference on Environmental Systems (ICES) Norfolk, Virginia July 17-20, 2006: 2006.
- ⁶³ Barker, R. S., and von Jouanne, R., *Space Station THC/IMV Development Test / Analysis Correlations and Flight Predictions*, 1997.
- ⁶⁴ Wieland, P. O., *Designing for Human Presence in Space: An Introduction to Environmental Control and Life Support Systems (ECLSS) -Appendix I, Update - Historical ECLSS for U.S. and U.S.S.R./Russian Space Habitats*, NASA Marshall Space Flight Center, Alabama: NASA, 2005.
- ⁶⁵ Mars One, "Mars One Living Unit" Available: <http://www.mars-one.com/technology/living-unit>.
- ⁶⁶ Williams, D. E., and Dake, J. R., *International Space Station Environmental Control and Life Support System Status for the Prior Year : 2010 - 2011*, AIAA 2012-3612, 42nd International Conference on Environmental Systems 15 - 19 July 2012, San Diego, California: 2012.
- ⁶⁷ Wright, J., "Permanent Multipurpose Module," *NASA International Space Station* Available: http://www.nasa.gov/mission_pages/station/structure/elements/pmm.html#.VA772PldV8E.
- ⁶⁸ Jeng, F. F., and Lin, C. H., "A Trade Study on Sabatier CO2 Reduction Subsystem for Advanced Missions," *31st International Conference on Environmental Systems*, Orlando: SAE International, 2001.
- ⁶⁹ Jones, H., "Reliability Analysis of Carbon Dioxide Reduction Systems," *41st International Conference on Environmental Systems*, 2011, pp. 1–10.
- ⁷⁰ Jones, H., "Design and Analysis of a Flexible, Reliable Deep Space Life Support System," *42nd International Conference on Environmental Systems*, San Diego, California: AIAA, 2012, pp. 1–27.
- ⁷¹ Stilwell, D., Boutros, R., and Connolly, J. H., "Crew Accommodations," *Human Spaceflight: Mission Analysis and Design*, W.J. Larson and L.K. Pranke, eds., McGraw-Hill Higher Education, 2000.
- ⁷² Lien, R., "Advanced Resistive Exercise Device (ARED)," *ISS Science for Everyone* Available: http://www.nasa.gov/mission_pages/station/research/experiments/1001.html.
- ⁷³ "Do Tread On Me," *International Space Station Feature* Available: http://www.nasa.gov/mission_pages/station/behindsceenes/colbert_feature.html.
- ⁷⁴ "Cycle Ergometer with Vibration Isolation and Stabilization System (CEVIS)," *ISS Science for Everyone* Available: http://www.nasa.gov/mission_pages/station/research/experiments/841.html.

⁷⁵ “Standard Specification for Pressure Vessel Plates, Alloy Steel, High-Strength, Quenched and Tempered (A517/A517M-10),” 2014, pp. 10–13.

⁷⁶ “ASTM A517 Low Alloy Steel, Grade A,” *MatWeb Material Property Data*.

⁷⁷ Murdock, K., “Integrated Evaluation of Closed Loop Air Revitalization System Components,” 2010.

⁷⁸ Cadogan, D., and Scheir, C., “Expandable Habitat Technology Demonstration for Lunar and Antarctic Applications,” 2008, pp. 776–790.

A. HABITATION MODULE ASSUMPTIONS

Parameter	Value	Reference / Comments
Time Horizon (Mission Duration)	26 months (19000hours)	This corresponds to the period between launch windows to Mars from Earth – that is, the period between resource and hardware resupply opportunities. This is the minimum continuous period over which the habitat must be self-sufficient.
Number of Crew	4	Specified by the Mars One Foundation ⁵
Habitat Atmosphere	70.3kPa, 26.5% O ₂ Diluent gas: N ₂	The Mars One Foundation states that the habitat atmosphere will be 0.7bar ⁴ . The equivalent atmosphere studied by the NASA Exploration Atmospheres Working Group (EAWG) is a 26.5% O ₂ mixture. This corresponds to the Space Shuttle atmosphere employed prior to and during extravehicular activity (EVA) operations ¹⁴
Habitat Volume	6x scaled up Dragon capsules (each 25m ³) and 2x Inflatable modules (each 500m ³)	See Section III-IV for a discussion on the assumed SpaceX Dragon modules volume. The inflatable module is specified on the Mars One website ⁵⁵
Habitat Leakage Rate	0.05% lost by mass per day	Value taken from Table 4.1.1 of BVAD ¹⁵
ECLS Architecture	Based on that of the International Space Station	Explicit claim made by the Mars One Foundation regarding the life support unit: <i>“This system will be very similar to those units which are fully functional on-board the International Space Station.”</i> ¹⁹
Food System	Entirely locally grown	The Mars One foundation plans for 50m ² dedicated to plant growth. Moreover, they claim that this: <i>“will be sufficient plant production capacity to feed about three crews of four”</i> ⁵⁶
EVA Frequency	5 EVAs/week, 2 crewmembers per EVA, 8 hours per EVA	Although not explicitly specified, the description on the Mars One website ⁵⁷ implies that EVAs will occur frequently. The NASA Baseline Values and Assumptions (BVAD) document suggests a nominal EVA duration of 8 hours and a maximum EVA frequency of 5 two-person EVAs per week ¹⁵
Spacesuit pressure	29.6kPa (4.3 psi), at 100% O ₂	EAWG recommended suit pressure for EVAs requiring dexterous tasks. This suit pressure also limits the O ₂ in-suit prebreathe time from the 70.3kPa habitat atmosphere to about 40 minutes ¹⁴
Spacesuit Portable Life Support System (PLSS)	NASA PLSS2.0 Architecture	Currently in development, the PLSS2.0 architecture is the current the state of the art in spacesuit life support systems ⁵⁸ . Unlike the spacesuits currently used on the International Space Station, the PLSS2.0 is capable of supporting a crewmember on the Martian surface.
Spacesuit Urine Management	Urine Collection and Transfer Assembly (UCTA)	Astronauts currently performing EVA from the ISS wear Maximum Absorbency Garments (MAGs) to collect their urine. These are then discarded at the end of the EVA. The large number of EVAs anticipated for Mars One means that choosing to discard urine expelled during EVA can become a major source of water loss to the system over time. To overcome this, we have assumed an Apollo like system, where urine is collected in a bag attached to the astronaut’s thigh ⁵⁹ . The collected urine can then be emptied back into the habitat’s urine processor for water recovery.
Airlock cycle losses	Equivalent to 13.8kPa within an assumed	The discussion at Reference 21 implies that airlocks will be used rather than other means of habitat entry (such as suitports). Here we assume an airlock

	3.7m ³ airlock	volume of 3.7m ³ , which corresponds to the minimum volume that can accommodate 2 crewmembers at a time ¹⁵ . The gaseous loss of 13.8kPa corresponds to the minimum pressure that the current ISS Quest Airlock depressurization pump can be operated down to ⁶⁰
Potable Water Tanks	2x 1500L capacity tanks	The Mars One foundation states that 3000L of water will be produced and stored locally prior to the arrival of the first crew ⁴
Oxygen Tanks	120kg capacity	The Mars One foundation states that 120kg of oxygen will be produced and stored locally prior to the arrival of the first crew ⁴
Nitrogen Tanks	292kg capacity	Corresponds to the amount of nitrogen required to mix with 120kg of O ₂ to produce a 26.5% O ₂ (molar percentage) atmosphere

B. ASSUMED ECLS TECHNOLOGIES EMPLOYED WITHIN THE MARS ONE HABITAT

ECLS Function	ECLS Technology	Corresponding ISS USOS Technology	Location of Technology on ISS
Gas Storage	High Pressure Tanks	High pressure N ₂ and O ₂ tanks	Installed on the exterior of the Quest airlock ⁴²
O₂ Generation	Solid Polymer Water Electrolysis	Oxygen Generation Assembly (OGA)	Installed in the Oxygen Generation System (OGS) rack in Node 3 ⁶¹
CO₂ Removal	Molecular Sieve (Zeolite5A)	Carbon Dioxide Removal Assembly (CDRA)	One is installed in the Air Revitalization (AR) rack within Node 3, and another is installed in the AR rack in the Destiny Laboratory ⁶²
CO₂ Reduction	Sabatier Reactor	CO ₂ Reduction Assembly (CRA)	Installed in the Oxygen Generation System (OGS) rack in Node 3 ⁶²
Humidity Control	Condensing Heat Exchanger	Common Cabin Air Assembly (CCAA)	Located in all USOS modules except for Node 1 and the PMM ⁶³
Water Storage	Bellows Tanks and Soft Containers	WPA Product Water Tank and Contingency Water Containers (CWCs)	Located throughout the ISS ²⁹
Water Processing	Vapor Compression Distillation & Multifiltration	Urine Processor Assembly (UPA) and Water Processor Assembly (WPA)	Installed in the Water Recovery System (WRS) Racks 1 and 2 in Node 3 ⁶²
Waste Processing	Water recovered from urine via VCD. Faeces and brine disposed in logistics resupply vehicles	Advanced Recycle Filter Tank Assembly (ARFTA) collects brine and sends it to Rodnik tanks on the Progress vehicle, or one of the water tanks on ATV. Faeces is collected in a waste canister and disposed of in one of the resupply vehicles	One of the several logistics resupply vehicles that visit the ISS ⁶⁴

C. HEURISTICS USED FOR ECLS TECHNOLOGY LOCATION ALLOCATION

Mars One Habitation Module	Life Support Functions supported by Habitation Module	Analogous ISS Module	Comments
Inflatable	Main living area of the habitat. Supports recreation and houses food production units (See Figure 5) ²³	Node 3 and Destiny Laboratory	The exercise equipment on the ISS USOS is distributed across the Destiny Laboratory and Node 3
Living Unit	Contains airlock and habitat "wet areas", such as the shower and kitchen ⁶⁵	Quest Airlock and Node 3	Node 3 contains the Waste and Hygiene Compartment ⁶⁶ , while the Quest airlock serves all airlock functions on the U.S. Segment
Life Support Unit	Contains ECLS and ISRU technologies, as well as solar arrays ¹⁹	Node 3	The majority of ECLSS technologies are located within Node 3 ⁶⁶
Cargo / Supply Unit	Storage volume for hardware, spare parts and consumables ³⁹	Permanent Multipurpose Module (PMM)	The PMM was added to the ISS primarily to increase on-orbit storage volume ⁶⁷

D. CROP STATIC PARAMETERS

Crop	Carbohydrate Fraction of Dry Mass (c)*	Protein Fraction of Dry Mass (p)*	Fat Fraction of Dry Mass (f)*	Average Growth Rate (g/m²/day) (r)[†]	Time to Crop Maturity (days)[‡]	Mature Plant Height (m)[‡]
Dry (Kidney) Bean	0.711	0.279	0.010	9.064	63	0.5
Lettuce	0.655	0.311	0.034	20.04	30	0.25
Peanut	0.173	0.286	0.542	4.131	110	0.65
Rice	0.919	0.075	0.006	11.86	88	0.8
Soybean	0.348	0.421	0.230	6.867	86	0.55
Sweet Potato	0.925	0.072	0.002	18.29	120	0.65
Tomato	0.783	0.177	0.040	6.609	80	0.4
Wheat	0.866	0.112	0.023	26.74	62	0.5
White Potato	0.898	0.096	0.006	16.82	138	0.65

*Data obtained from the United States Department of Agriculture National Nutrient Database for Standard Reference – Release 27. Available at: <http://ndb.nal.usda.gov/ndb/>, Accessed: August 30th 2014

[†]Determined through simulation of the Modified Energy Cascade crop models under nominal conditions

[‡]Data obtained from the NASA Baseline Values and Assumptions Document NASA CR-2004-208941

E. COMPONENT DATA

	Assembly	Subassembly	Mass [kg]	Volume [m ³]	MTBF [h]	LL [y]	Pmry. Sedry.	
ECLSS	OGA	Hydrogen Sensor	4.36	0.0034	61845.6	0.25	1 1	
		Inlet Deionizing Bed	28.67	0.0295	296701.2	6.00	1 1	
		Nitrogen Purge ORU	34.25	0.0312 [*]	138408.0		1 1	
		Oxygen Outlet	48.17	0.0312	98112.0	10.00	1 1	
		Power Supply Module	42.64	0.0649	47479.2	4.17	1 1	
		Process Controller	47.08	0.0838	103280.4	7.72	1 1	
		Pump	17.96	0.0102	144540.0	1.00	1 1	
		Air Pump Two-Stage ORU	10.89	0.0045	156200.0	15.29	2 2	
		Blower	5.58	0.0300	129700.0	10.00	2 2	
		Check Valves	39.92	0.1784	32900.0 [†]		2 2	
	CDRA/ORA (x2)	Desiccant Beds	42.64	0.0850	77100.0		4 4	
		Heat Controller	3.31	0.0085	242700.0		4 4	
		Precooler	5.58	0.0255	129700.0	10.00	2 2	
		Pump Fan Motor Controller	2.72	0.0057	2270000.0		4 4	
		Selector Valves	3.04	0.0017	117000.0	10.61	12 12	
		Sorbent Beds (Zeolite)	42.64	0.0850	77100.0	2.28	4 4	
		Condensing Heat Exchanger	49.71	0.3933	832600.0		4 4	
		Electronic Interface Box (EIB)	4.04	0.0173	2350000.0		8 8	
		Fan Delta Pressure Sensor	0.45	0.0002	1250000.0		4 4	
		Heat Exchanger Liquid Sensor	0.64	0.0006	1140000.0		8 8	
	CCAA (x4)	Inlet ORU	25.31	0.1309	333000.0		4 4	
		Pressure Transducer	0.48	0.0000	1250000.0	15.00	4 4	
		Temperature Control Check Valve (TCCV)	7.45	0.0071	32900.0		8 8	
		Temperature Sensor	0.26	0.0014	37600000.0		16 16	
		Water Separator	11.93	0.0583	131000.0	5.00	8 8	
		Water Separator Liquid Sensor	0.64	0.0006	1140000.0 [‡]		8 8	
		UPA	Distillation Assembly	92.76	0.1422	142525.2	2.00	1 1
			Firmware Controller Assembly	23.09	0.0286	27331.2	2.40	1 1
			Fluids Control and Pump Assembly	47.58	0.0731	90140.4	4.00	1 1
			Pressure Control and Pump Assembly	49.08	0.1158	181507.2	2.00	1 1
	Recycle Filter Tank Assembly		15.38	0.1011	199640.4	0.08	1 1	
	WPA	Separator Plumbing Assembly	16.78	0.0229	384651.6	1.00	1 1	
		Catalytic Reactor	67.04	0.1156	25579.2	2.25	1 1	
		Gas Separator	39.15	0.0660	84008.4	1.00	1 1	
		Ion Exchange Bed	13.02	0.0173	296701.2	0.16	1 1	
		Microbial Check Valve	5.76	0.0065	143488.8	1.00	1 1	
		Multifiltration Bed #1	149.23	0.0657	296701.2	0.36	1 1	
		Multifiltration Bed #2	149.23	0.0657	296701.2	0.36	1 1	
		Particulate Filter	32.25	0.0717	717356.4	0.22	1 1	
		pH Adjuster	2.54	0.0026	137181.6	1.00	1 1	
		Process Controller	45.00	0.0838	87950.4	7.72	1 1	
		Pump Separator	31.34	0.0869	42398.4	2.00	1 1	
		Reactor Health Sensor	16.83	0.0425	56677.2	1.00	1 1	
		Sensor	4.81	0.0034	143664.0	10.00	1 1	
		Separator Filter	7.67	0.0102	359072.4	0.84	1 1	
		CRA	Start-up Filter	9.44	0.0184	226884.0	19.92	1 1
	Water Delivery		47.54	0.0974	64561.2	5.00	1 1	
	Sabatier Methanation Reactor		120.00 ^{§§}	0.2080 ^{§§}	50000.0 ^{§§§}		1 1	
	Condensing Heat Exchanger [§]		49.71	0.3933	832600.0		1 1	
	Phase Separator ^{**}		11.93	0.0583	131000.0	5.00	1 1	
	Valves ^{††}		3.04	0.0017	117000.0	10.61	7 ⁷⁰ 7 ⁷⁰	
	Sensors ^{‡‡}		4.81	0.0034	143664.0	10.00	1 1	
	Controller		3.00 ^{§§}	0.0053 ^{§§}	103280.4 ^{****}	7.72 ^{***}	1 1	
	Compressor		27.00 ^{§§}	0.0112 ^{†††}	66666.7 ^{§§§}		1 1	
	Mechanization Systems and Secondary Structure		1960.00	14.2649 ^{‡‡‡}			1 0	
	GLS	LED Growth Light ORU ²⁸	13.00	0.0359	871839.6 ^{§§§§}		875 0	
		Storage	O2 Tank	21.84	0.2802 ^{****}			1 1
			N2 Tank	80.95	0.6868 ^{****}			1 1
			CO2 Accumulator ^{††††}	0.06	0.0207			1 1
			Potable Water Tank	100.21 ^{‡‡‡}	0.0500 ^{§§§§}			1 1
			Dirty Water Tank	10.50 ^{*****}	0.0090			1 1
			Grey Water Tank	53.05 ^{*****}	0.0455			1 1
			Crop Water Tank	734.80 ^{‡‡‡}	0.3667 ^{§§§§}			1 0
			Biomass Storage	[negligible]	[negligible]			1 0
			Food Storage (406kg) ^{†††††}	477.65	0.0004			1 1
	Zeolite and Support Structure ^{†††††}		34.93	0.0561	77100.0 [*]		1 1	
	ISRU	AP						

* Analogy to OGA Oxygen Outlet

† Analogy to CCAA TCCV

‡ Analogy to Heat Exchanger Liquid Sensor in CCAA

§ Analogy to CCAA Condensing Heat Exchanger

** Analogy to CCAA Water Separator

†† Analogy to CDRA Selector Valves

‡‡ Analogy to WPA sensor

§§ Linear scaling (based on mass) from OGA Process Controller

*** Analogy to OGA Process Controller

††† Linear scaling (based on mass) from CDRA Air Pump

‡‡‡ Assumed to have same packed density as infl. hab.

§§§ Assuming 1-yr warranty accounts for 1% failures during that time²⁸**** Linear scaling from ISS O2/N2 tanks⁴²†††† Based on hoop stress calculations of a 0.73ft³ spherical tank @ 130psia (factor of safety 2, A517 steel)⁷⁵⁻⁷⁷

‡‡‡‡ Linear scaling based on ISS Contingency Water Container

§§§§ Assumes 30:1 packing efficiency, twice that of infl. hab.

***** Linear scaling from UPA Wastewater Storage Tank

††††† Based on ISS Phase III packaging

‡‡‡‡‡ Based on geometric calculations^{35,36}

		Compressor [†]	70.54	0.4079	66666.7 [‡]	2	2
		Cryocooler [§]	10.08	0.0049	500000.0 ^{**}	4	4
	SP ^{††}	Mixing Auger	2.52	0.0000	500000.0 ^{**}	1	1
		Feed Cone	5.27	0.0691	500000.0 ^{**}	1	1
		Hopper	2.86	0.0033		1	1
		Horizontal Feed Auger	1.31	0.0044	500000.0 ^{**}	1	1
		Condensing Heat Exchanger	80.78	0.6391	832600.0	1	1
		Oven Heater	12.53	0.0138	242700.0	1	1
PDISRU	AP	Zeolite and Support Structure ^{‡‡‡‡}	66.37	0.1064	77100.0 [*]	1	0
		Compressor [†]	134.03	0.7751	66666.7 [‡]	2	0
		Cryocooler [§]	10.08	0.0049	500000.0 ^{**}	4	0
	SP ^{††}	Mixing Auger	574.12	0.0000	500000.0 ^{**}	1	0
		Feed Cone	196.77	1.2690	500000.0 ^{**}	1	0
		Hopper	61.84	0.7397		1	0
		Horizontal Feed Auger	1.31	0.0044	500000.0 ^{**}	1	0
		Condensing Heat Exchanger	80.78	0.6391	832600.0	1	0
		Oven Heater	12.53	0.0138	242700.0	1	0
Inflatable Habitat			4580.00	33.3333 ^{‡‡}		1	1
Crew Systems ⁷¹	Galley and Food System	Freezers	400.00	2.0000		1	0
		Conventional oven	50.00	0.2500		1	0
		Microwave ovens (2 ea.)	70.00	0.3000		1	0
		Kitchen/oven cleaning supplies (fluids, sponges, etc.)	197.92	1.4250		1	0
		Sink, spigot for hydration of food and drinking water	15.00	0.0135		1	0
		Dishwasher	40.00	0.5600		1	0
		Cooking/eating supplies (pans, plastic dishes, plates, etc.)	20.00	0.0056		1	0
	Waste Collection System	Waste Collection System (2 toilets)	90.00	4.3600		1	0
		WCS supplies (toilet paper, cleaning solutions, filters, etc.)	158.33	4.1167		1	0
		Contingency fecal and urine collection mittens/bags	728.33	2.5333		1	0
	Personal Hygiene	Shower	75.00	1.4100		1	0
		Handwash/mouthwash faucet	8.00	0.0100		1	0
		Personal hygiene kit	7.20	0.0750		1	0
		Hygiene supplies	237.50	4.7500		1	0
	Clothing	Clothing	396.00	1.3440		1	0
		Washing machine	100.00	0.7500		1	0
		Clothes dryer	60.00	0.7500		1	0
	Recreational Equipment and Personal Stowage/Closet Space		200.00	3.0000		1	0
	Housekeeping	Vacuum	13.00	0.0700		1	0
		Trash compactor/trash lock	150.00	0.3000		1	0
		Trash bags	158.33	3.1667		1	0
	Operational Supplies and Restraints	Operational Supplies and Restraints	80.00	0.0080		1	0
		Restraints and mobility aids	100.00	0.5400		1	0
	Photography	Equipment	120.00	0.5000		1	0
	Sleep Accommodations	Sleep Provisions	36.00	0.4000		1	0
	Crew Healthcare	Medical/Surgical/Dental suite	1000.00	4.0000		1	0
		Medical/Surgical/Dental consumables	500.00	2.5000		1	0
	Exercise Equipment	ARED ⁷²	317.51	1.3592 ^{§§}		1	0
		COLBERT ⁷³	997.90	0.3398 ^{§§}		1	0
		CEVIS ⁷⁴	26.76	0.0850 ^{§§}		1	0
	EVA	Battery ^{***}	6.33	0.0048 ^{†††}	0.12 ^{‡‡‡}	2	2
		Misc. Hardware	78.04 ^{§§§}	0.6680 ^{****}		2	2

Table E1: Component data for the baseline Mars One case. The mass, volume, MTBF, and LL of each component considered in this analysis are shown, along with the number of each component present in the primary and secondary systems. This table represents the BPS architecture, which includes plant growth for food production. As such, the notional ORA hardware is included, assumed to be identical to the CDRA for the purposes of this analysis. In addition, the ISRU and PDISRU systems are sized for a BPS case load. Unless otherwise noted, values are from the *Advanced Life Support Baseline Values and Assumptions Document*¹⁵. Assumptions and use of analogy to other components for data are indicated and described with footnotes.

* Analogy to CDRA Sorbent Beds

† Based on geometric calculations³⁴

‡ Analogy to CRA Compressor

§ Based on geometric calculations³⁷

** Optimistic assumption (no data were available)

†† Parametrically scaled from⁷

‡‡ Assuming 15:1 packing efficiency⁷⁸

§§ Estimated based on images

*** Analogy to EMU Series 2000 Battery⁴⁰

††† Assumed to be 1/2 volume of METOX canister, based on drawings⁴⁰

‡‡‡ Life limit of 32 EVAs at a rate of 5 EVAs/wk⁴⁰

§§§ Based on Apollo A7LB Suit, minus battery mass^{15,40}

**** Based on rough volume of EMU HUT and PLSS (other components assumed to fit within that volume)⁴⁰

Group	Assembly	Subassembly	Mass [kg]	Volume [m ³]
ECLSS	Storage	Food Storage (406kg) [*]	477.65	0.0004
ISRU	AP	Zeolite and Support Structure [†]	34.93	0.0561
		Compressor [‡]	70.54	0.4079
	SP ^{**}	Cryocooler [§]	10.08	0.0049
		Mixing Auger	2.52	0.0000
		Feed Cone	5.27	0.0691
		Hopper	2.86	0.0033
		Horizontal Feed Auger	1.31	0.0044
		Condensing Heat Exchanger	80.78	0.6391
		Oven Heater	12.53	0.0138
		Zeolite and Support Structure [†]	66.37	0.1064
PDISRU	AP	Compressor 1 (Mars to 1atm) [‡]	134.03	0.7751
		Cryocooler [§]	10.08	0.0049
	SP ^{**}	Mixing Auger	574.12	0.0000
		Feed Cone	196.77	1.2690
		Hopper	61.84	0.7397
		Horizontal Feed Auger	1.31	0.0044
		Condensing Heat Exchanger	80.78	0.6391
		Oven Heater	12.53	0.0138

Table E2: Changes to component data for the stored food case. The mass of stored food changes to account for the lack of plant-produced food. The ISRU and PDISRU mass and volume are different due to different loads on the system. In addition, the BPS, GLS, ORA, Crop Water Tank, and Biomass Storage are removed.

^{*} Based on ISS Phase III packaging

[†] Based on geometric calculations^{35,36}

[‡] Based on geometric calculations³⁴

[§] Based on geometric calculations³⁷

^{**} Parametrically scaled from⁷

F. SPARES REQUIRED

Group	Subgroup	Subassembly	Random	Scheduled	Dominant Mechanism	Spares
ECLSS	OGA	Hydrogen Sensor	5	8	Scheduled	8
		Inlet Deionizing Bed	3	0	Random	3
		Nitrogen Purge ORU	4		Random	4
		Oxygen Outlet	4	0	Random	4
		Power Supply Module	5	0	Random	5
		Process Controller	4	0	Random	4
		Pump	4	2	Random	4
	CDRA/ORA (x2)	Air Pump Two-Stage ORU	6	0	Random	6
		Blower	8	0	Random	8
		Check Valves	12		Random	12
		Dessicant Beds	16		Random	16
		Heat Controller	12		Random	12
		Precooler	8	0	Random	8
		Pump Fan Motor Controller	8		Random	8
		Selector Valves	48	2	Random	48
		Sorbent Beds (Zeolite)	16	3	Random	16
		Condensing Heat Exchanger	8		Random	8
	CCAA (x4)	Electronic Interface Box (EIB)	16		Random	16
		Fan Delta Pressure Sensor	8		Random	8
		Heat Exchanger Liquid Sensor	16		Random	16
		Inlet ORU	12		Random	12
		Pressure Transducer	8	0	Random	8
		Temperature Control Check Valve (TCCV)	48		Random	48
		Temperature Sensor	16		Random	16
		Water Separator	32	3	Random	32
		Water Separator Liquid Sensor	16		Random	16
		Distillation Assembly	4	1	Random	4
	UPA	Firmware Controller Assembly	6	0	Random	6
		Fluids Control and Pump Assembly	4	0	Random	4
		Pressure Control and Pump Assembly	3	1	Random	3
	WPA	Recycle Filter Tank Assembly	3	25	Scheduled	25
		Separator Plumbing Assembly	3	2	Random	3
		Catalytic Reactor	7	0	Random	7
		Gas Separator	4	2	Random	4
		Ion Exchange Bed	3	12	Scheduled	12
		Microbial Check Valve	4	2	Random	4
		Multifiltration Bed #1	3	5	Scheduled	5
		Multifiltration Bed #2	3	5	Scheduled	5
		Particulate Filter	2	9	Scheduled	9
		pH Adjuster	4	2	Random	4
		Process Controller	4	0	Random	4
		Pump Separator	5	1	Random	5
		Reactor Health Sensor	5	2	Random	5
	Sensor	4	0	Random	4	
	Separator Filter	3	2	Random	3	
	Start-up Filter	3	0	Random	3	
	Water Delivery	5	0	Random	5	
	CRA	Sabatier Methanation Reactor	5		Random	5
		Condensing Heat Exchanger	2		Random	2
		Phase Separator	4	0	Random	4
		Valves	28	1	Random	28
		Sensors	4	0	Random	4
		Controller	4	0	Random	4
Compressor		5		Random	5	
GLS	LED Growth Light ORU	40		Random	40	
ISRU (Crew System)	AP	Zeolite and Support Structure	4		Random	4
		Compressor	10		Random	10
	SP	Cryocooler	8		Random	8
		Mixing Auger	2		Random	2
		Feed Cone	2		Random	2
		Horizontal Feed Auger	2		Random	2
		Condensing Heat Exchanger	2		Random	2
Oven Heater	3		Random	3		
ISRU (Pre-Deployed)	AP	Zeolite and Support Structure	4		Random	4
		Compressor 1 (Mars to 1atm)	10		Random	10
		Cryocooler	8		Random	8
	SP	Mixing Auger	2		Random	2
		Feed Cone	2		Random	2
		Horizontal Feed Auger	2		Random	2
		Condensing Heat Exchanger	2		Random	2
Oven Heater	3		Random	3		
Crew Systems	EVA	Battery		32	Scheduled	32

Table F1: Results of the sparing analysis for the first crew for the BPS case. The number spares needed to cover random failures and scheduled repairs is shown. The dominant mechanism is defined based upon which mechanism (random or scheduled) requires more spares; that number of spares is the number that is required.

Group	Subgroup	Subassembly	Random	Scheduled	Dominant Mechanism	Spares
ECLSS	OGA	Hydrogen Sensor	4	8	Scheduled	8
		Inlet Deionizing Bed	2	0	Random	2
		Nitrogen Purge ORU	3		Random	3
		Oxygen Outlet	3	0	Random	3
		Power Supply Module	4	0	Random	4
	CDRA	Process Controller	3	0	Random	3
		Pump	3	2	Random	3
		Air Pump Two-Stage ORU	3	0	Random	3
		Blower	3	0	Random	3
		Check Valves	5		Random	5
		Dessicant Beds	8		Random	8
		Heat Controller	6		Random	6
		Precooler	3	0	Random	3
		Pump Fan Motor Controller	2		Random	2
		Selecter Valves	18	1	Random	18
	CCAA (x4)	Sorbent Beds (Zeolite)	8	1	Random	8
		Condensing Heat Exchanger	8		Random	8
		Electronic Interface Box (EIB)	8		Random	8
		Fan Delta Pressure Sensor	8		Random	8
		Heat Exchanger Liquid Sensor	16		Random	16
		Inlet ORU	8		Random	8
		Pressure Transducer	8	0	Random	8
		Temperature Control Check Valve (TCCV)	40		Random	40
		Temperature Sensor	16		Random	16
		Water Separator	24	3	Random	24
	UPA	Water Separator Liquid Sensor	16		Random	16
		Distillation Assembly	3	1	Random	3
		Firmware Controller Assembly	6	0	Random	6
		Fluids Control and Pump Assembly	4	0	Random	4
		Pressure Control and Pump Assembly	3	1	Random	3
	WPA	Recycle Filter Tank Assembly	3	25	Scheduled	25
		Separator Plumbing Assembly	2	2	Random	2
		Catalytic Reactor	6	0	Random	6
		Gas Separator	4	2	Random	4
		Ion Exchange Bed	2	12	Scheduled	12
		Microbial Check Valve	3	2	Random	3
		Multifiltration Bed #1	2	5	Scheduled	5
		Multifiltration Bed #2	2	5	Scheduled	5
		Particulate Filter	2	9	Scheduled	9
		pH Adjuster	3	2	Random	3
		Process Controller	4	0	Random	4
		Pump Separator	5	1	Random	5
		Reactor Health Sensor	4	2	Random	4
		Sensor	3	0	Random	3
		Separator Filter	2	2	Random	2
	CRA	Start-up Filter	3	0	Random	3
		Water Delivery	4	0	Random	4
		Sabatier Methanation Reactor	4		Random	4
		Condensing Heat Exchanger	2		Random	2
		Phase Separator	3	0	Random	3
ISRU (Crew System)	Valves	21	1	Random	21	
	Sensors	3	0	Random	3	
	Controller	3	0	Random	3	
	Compressor	4		Random	4	
	AP	Zeolite and Support Structure	4		Random	4
	Compressor	8		Random	8	
	Cryocooler	8		Random	8	
	SP	Mixing Auger	2		Random	2
	Feed Cone	2		Random	2	
	Horizontal Feed Auger	2		Random	2	
ISRU (Pre-Deployed)	Condensing Heat Exchanger	2		Random	2	
	Oven Heater	3		Random	3	
	AP	Zeolite and Support Structure	4		Random	4
	Compressor 1 (Mars to 1atm)	8		Random	8	
	Cryocooler	8		Random	8	
	SP	Mixing Auger	2		Random	2
	Feed Cone	2		Random	2	
	Horizontal Feed Auger	2		Random	2	
	Condensing Heat Exchanger	2		Random	2	
	Oven Heater	3		Random	3	
Crew Systems	EVA	Battery		32	Scheduled	32

Table F2: Results of the sparing analysis for the first crew for the stored food case. The number spares needed to cover random failures and scheduled repairs is shown, based on the techniques described in the sparing methodology section. The dominant mechanism is defined based upon which mechanism (random or scheduled) requires more spares; that number of spares is the number that is required.